

A word from the editor

The book series “MARINE ECOLOGY – A Comprehensive Treatise on Life in Oceans and Coastal Waters” (organized and edited by Otto Kinne and contributed to by numerous outstanding experts over years) is now freely available with online Open Access.

Published in the years 1970 to 1984, the copyright for MARINE ECOLOGY was graciously transferred in 2008 by the original publisher, Wiley & Sons, to the editor.

The technical problems involved in the re-publication of the Treatise were mastered by Konstantin Kambach (Inter-Research). Unavoidably, the print quality of the final product is somewhat inferior to the original.

Otto Kinne

Oldendorf/Luhe
29.04.2008

MARINE ECOLOGY

A Comprehensive, Integrated Treatise on Life in Oceans
and Coastal Waters

Volume I ENVIRONMENTAL FACTORS

Volume II PHYSIOLOGICAL MECHANISMS

Volume III CULTIVATION

Volume IV DYNAMICS

Volume V OCEAN MANAGEMENT

MARINE ECOLOGY

A Comprehensive, Integrated Treatise on Life in Oceans
and Coastal Waters

Editor

OTTO KINNE

*Biologische Anstalt Helgoland
Hamburg, Federal Republic of Germany*

VOLUME III

Cultivation

Part 2

A Wiley-Interscience Publication

1977

JOHN WILEY & SONS

Chichester . New York . Brisbane . Toronto

Copyright © 1977, by John Wiley & Sons, Ltd.

All rights reserved.

No part of this book may be reproduced by any means, nor transmitted, nor translated into a machine language without the written permission of the publisher.

Library of Congress Cataloging in Publication Data (Revised):

Kinne, Otto.
Marine ecology.

Includes bibliographies

CONTENTS: v. 1. Environmental factors, 3 v.—
v. 2. Physiological mechanisms, 2 v.—v. 3. Cultivation.

1. Marine ecology—Collected works. I. Title.
QH541.5.S3K5 574.5'2636 79.121779

ISBN 0 471 01577 6 (vol. 3 pt. 2)

Printed in Great Britain at The Spottiswoode Ballantyne Press
by William Clowes & Sons Limited,
London, Colchester and Beccles.

FOREWORD
to
VOLUME III: CULTIVATION

'Cultivation' reviews the information which has accumulated on our present capacity for supporting marine micro-organisms, plants and animals under environmental and nutritive conditions which are, to a considerable degree, controlled. The volume is subdivided into three parts, containing the following chapters*:

Part 1

- Chapter 1: Introduction to Volume III
- Chapter 2: Cultivation of Marine Organisms:
Water-quality Management and Technology
- Chapter 3: Cultivation of Micro-organisms
- Chapter 4: Cultivation of Plants

Part 2

- Chapter 5.1: Cultivation of Animals—Research Cultivation

Part 3

- Chapter 5.11: Axenic Cultivation
- Chapter 5.2: Commercial Cultivation (Aquaculture)
- Chapter 6: Multispecies Cultures and Microcosms
- Chapter 7: Chemical Contamination of Culture Media:
Assessment, Avoidance and Control

We have made every effort to present comprehensive reviews, covering essential aspects of the cultivation of marine organisms. It soon became apparent, however, that only in a few cases, comparative, critical assessments of different culture methods and technologies were possible. Many publications suffer from insufficient detail, or even total lack of information regarding source, environmental history and nutrition of the organisms cultivated or the culture method employed. Exact data on environmental factors—such as light, temperature, salinity or dissolved gases—and on diet are absolute requirements for proper evaluation of the results presented. No less important are the origin of the organisms concerned, culture-water quality and technological aspects.

Culture methods are often an outcome of empiricism and intuition. A technique is tried, and if it works, the investigator sticks with it, rationalizing only afterwards the reasons for its application and success. The factors truly critical to success have

* See Editorial Note, p. vi.

rarely been pinpointed. Some portions of the reviews presented must, therefore, remain tentative, descriptive or pragmatical.

Cultivation is not an end in itself. It serves as a means to solve specific research problems. Due to the large variety of problems and the overwhelming diversity of marine life, a multitude of different culture methods have been developed. In fact, concepts, goals and techniques applied in cultivation diverge more than in other branches of marine ecology.

Most experiments conducted on marine organisms involve elements of cultivation. Micro-organisms, crustaceans, molluscs and fishes, for example, have been maintained, reared or bred in thousands of experiments. It was neither possible nor desirable to consider all publications in detail. We have attempted to settle the conflict between our intention to present comprehensive accounts and the need to avoid undue repetition by tabulating the information at hand or by referring to pertinent books or reviews.

I acknowledge with pleasure the support, advice and criticism received from the contributors, as well as from Drs. D. F. ALDERDICE, J. R. BRETT, H. P. BULNHEIM, G. PERSOONE, A. GAERTNER and D. SIEBERS. Additional supporters are mentioned at the end of the respective chapters. The assistance of M. BLAKE, V. CLARK, J. MARSCHALL, H. L. NICHOLS, I. SCHRITT and H. WITT is deeply appreciated.

O.K.

Editorial Note

The two chapters originally envisaged to comprise Part 3 of Volume III—Diseases of Plants and Diseases of Animals—will not be published in this form. Together with a general introduction, Chapter 9 will appear in a separate two-part book:

O. KINNE (Ed.) *Diseases of Marine Animals*, Wiley, London.

The reasons for this change in our original concept are (i) the fundamental importance of animal diseases not only for cultivation, but also for proper ecological assessment of both distribution and performance of marine organisms; (ii) the large amount of information available on diseases of marine animals; (iii) the rather restricted information presently at hand on diseases of marine plants.

CONTENTS
OF
VOLUME III, PART 2

Chapter 5 **Cultivation of Animals**

5.1	Research Cultivation	<i>O. Kinne</i>	579
(1)	Introduction		579
(2)	Protozoa		584
(a)	Zooflagellates		585
	<i>Acanthoecopsis</i> sp. and <i>Diaphanoeca grandis</i>		585
	<i>Amphidinium höfleri</i>		587
	<i>Crypthecodinium cohnii</i>		588
	<i>Noctiluca miliaris</i>		590
	<i>Oxyrrhis marina</i>		591
(b)	Amoeba		591
	<i>Acanthamoeba griffini</i>		592
	<i>Heteramoeba clara</i>		594
	<i>Naegleria gruberi</i>		595
(c)	Foraminifera		596
	<i>Allogromia laticollaris</i> , <i>Quinqueloculina lata</i> , <i>Rosalina leei</i> and <i>Spiroloculina hyalina</i>		597
	<i>Archaias angulatus</i>		600
	<i>Heterostegina depressa</i>		600
	<i>Marginopora vertebralis</i>		601
(d)	Ciliata		601
	<i>Condyllostoma</i> sp.		602
	<i>Diapylliculina rotunda</i> , <i>Eupylliculina</i> sp. and <i>Metapylliculina</i> <i>andrewsi</i>		602
	<i>Euplotes</i> species		603
	<i>Fabrea salina</i>		604
	<i>Favella campanula</i>		605
	<i>Keronopsis rubra</i>		606
	<i>Miamiensis avidus</i> , <i>M.</i> sp., <i>Parauronema virginiatum</i> and <i>Uronema nigricans</i>		607
	<i>Paramecium</i> species		610
	<i>Tintinnopsis</i> species		611
	<i>Uronema</i> species		612
	Other species		614
(e)	Suctorina		615
(f)	Protozoa from brine habitats		616
(g)	Biochemical interactions among cultured Protozoa		616

(h) Protozoa as assay and food organisms	620
(i) Protozoa: conclusions	621
(3) Porifera	627
(a) Nutrition	628
(b) Laboratory culture experiments	630
<i>Cliona celata</i>	632
<i>Hippospongia equina</i>	632
<i>Leucosolenia complicata</i>	633
<i>Lissodendoryx carolinensis</i>	633
<i>Microciona prolifera</i>	633
<i>Mycale</i> species	633
<i>Ophlitaspongia seriata</i>	633
<i>Sycon</i> species	635
(c) Establishment in public aquaria	638
(d) <i>In situ</i> culture	638
(e) Porifera as assay and food organisms	639
(f) Porifera: conclusions	640
(4) Cnidaria	641
(a) Scyphozoa	641
<i>Aurelia aurita</i>	642
<i>Cephea cephea</i>	643
<i>Chrysaora quinquecirrha</i>	643
<i>Mastigias papua</i>	644
<i>Rhopilema verrilli</i>	644
<i>Stephanoscyphus planulophorus</i>	645
Other species	647
(b) Cubozoa	648
(c) Hydrozoa	650
General methods	652
Hydroid medusae	653
<i>Bougainvillia</i> sp.	654
<i>Campanularia flexuosa</i>	655
<i>Clava multicornis</i>	655
<i>Cordylophora caspia</i>	656
<i>Dipurena reesi</i> and <i>Eirene viridula</i>	658
<i>Hydractinia echinata</i>	658
<i>Obelia</i> species	659
<i>Pennaria tiarella</i>	660
<i>Podocoryne carnea</i>	660
Difficult-to-cultivate species	660
(d) Anthozoa	661
<i>Alcyonium digitatum</i>	662
<i>Fungia scutaria</i> and <i>Pocillopora damicornis</i>	662
<i>Ptilosarcus guerneyi</i>	663
<i>Zoanthus sandwichensis</i>	663
Other species	664
Chemical aspects of feeding	664

CONTENTS

ix

(e) Cnidaria as assay and food organisms	665
(f) Cnidaria: conclusions	666
(5) Turbellaria	668
(a) Major species cultivated	668
<i>Archaphanostoma agile</i> , <i>Pseudaphanostoma psammophilum</i> and <i>Pseudohaplogonaria vacua</i>	668
<i>Bursosaphia baltalimaniaformis</i> , <i>Otocelis rubropunctata</i> and <i>O.</i> <i>westbladi</i>	668
<i>Childia groenlandica</i>	669
<i>Convoluta</i> species	669
<i>Monocelis</i> species	671
<i>Otocelis luteola</i>	672
(b) Reproductive biology	674
(c) Turbellaria as assay and food organisms	678
(d) Turbellaria: conclusions	678
(6) Rotifera	678
(a) Major species cultivated	679
<i>Brachionus plicatilis</i>	679
<i>Colurella colurus</i> and <i>Keratella cruciformis</i>	684
Limnic representatives	684
(b) Rotifera as assay and food organisms	688
(c) Rotifera: conclusions	689
(7) Nematoda	691
(a) Major species cultivated	692
<i>Aphelenchoides marinus</i>	692
<i>Chromadora macrolaimoides</i>	692
<i>Diplolaimella ocellata</i>	696
<i>Metoncholaimus scissus</i>	697
<i>Monhystera</i> species	697
<i>Panagrellus</i> sp.	701
<i>Rhabditis marina</i>	702
<i>Theristus pertenuis</i>	703
(b) Other species	703
(c) Nematoda as assay and food organisms	707
(d) Nematoda: conclusions	708
(8) Bryozoa	709
(a) Major species cultivated	715
<i>Alcyonidium</i> species	715
<i>Bugula</i> species	716
<i>Membranipora membranacea</i>	716
<i>Zoobotryon verticillatum</i>	717
(b) Other species	718
(c) Bryozoa as assay and food organisms	719
(d) Bryozoa: conclusions	719

(9) Annelida	720
(a) Polychaeta	720
<i>Arenicola marina</i>	720
<i>Autolytus prolifer</i>	722
<i>Brania (Grubea) clavata</i>	723
<i>Capitella</i> species	723
<i>Eunice viridis</i>	723
<i>Hydroides</i> species	724
<i>Lanice conchilega</i>	725
<i>Mercierella enigmatica</i>	725
<i>Nereis</i> species	725
<i>Ophryotrocha</i> species	729
<i>Platynereis dumerilii</i>	731
<i>Pomatoceros triqueter</i>	732
<i>Sabellaria vulgaris</i>	733
Other species	733
(b) Oligochaeta	735
<i>Enchytraeus</i> species	735
<i>Tubifex hattai</i>	735
(c) Annelida as assay and food organisms	736
(d) Annelida : conclusions	739
(10) Crustacea	742
(a) Branchiopoda	743
<i>Artemia salina</i>	743
Egg incubation and hatching	744
Rearing of larvae, subadults and adults	746
Branchiopoda as assay and food organisms	747
Separation of egg shells and harvesting of larvae	748
Egg-shell contamination	755
Continuous cultures	756
Automatic feeders	757
Differences in quality and food value	759
Branchiopoda : conclusions	761
(b) Copepoda	761
Benthic copepods	762
<i>Tigriopus</i> species	763
<i>Tisbe</i> species	765
Other species	766
Planktonic copepods	766
<i>Acartia</i> species	767
<i>Calanus</i> species	769
<i>Euchaeta japonica</i>	775
<i>Eurytemora</i> species	775
<i>Euterpina acutifrons</i>	777
<i>Metridia</i> species	780
<i>Pseudocalanus</i> species	781
<i>Rhincalanus nasutus</i>	783

Other species	785
Copepoda as assay and food organisms	786
Copepoda: conclusions	787
(c) Cirripedia	798
Rearing of larvae	799
Food for larvae	800
Breeding	802
<i>Balanus</i> species	803
<i>Elminius modestus</i>	804
<i>Pollicipes polymerus</i>	806
Other species	806
Cirripedia as assay and food organisms	807
Cirripedia: conclusions	807
(d) Malacostraca	808
Mysidacea, Isopoda, Amphipoda	808
Euphausiacea	809
Decapoda	812
General aspects	812
Nutritional requirements	814
Natural food sources	814
Diets offered in culture experiments	815
Dietary composition	823
Protein	823
Amino acids	826
Minerals and vitamins	828
Pelleted dry foods and binders	833
Food ration and conversion efficiency	837
Decapoda Natantia (Shrimps and Prawns)	840
<i>Alpheus</i> species	841
<i>Crangon</i> species	841
<i>Leander squilla</i>	842
<i>Macrobrachium</i> species	842
<i>Metapenaeus</i> species	846
<i>Palaemon</i> species	847
<i>Palaemonetes</i> species	849
<i>Pandalus</i> species	851
<i>Penaeus japonicus</i>	851
Reproduction	852
Rearing of larvae	852
Production of seedlings	854
Seedling transportation	854
Fattening	855
Extensive embayment culture	855
Stocking	856
<i>Penaeus monodon</i>	856
Other <i>Penaeus</i> species	856
<i>Sergestes lucens</i>	858

Decapoda Reptantia (Lobsters and Crabs)	859
Lobsters: general aspects	859
<i>Homarus</i> species	859
Rearing of larvae	860
Rearing of juveniles	865
<i>Nephrops norvegicus</i>	870
Spiny and Spanish lobsters (Scyllaridae)	871
Crabs: general aspects	873
<i>Cancer irroratus</i>	874
<i>Carcinus maenas</i>	875
<i>Emerita talpoida</i>	876
<i>Menippe mercenaria</i>	876
<i>Pagurus</i> species	877
<i>Rhithropanopeus harrisi</i>	877
<i>Scylla serrata</i>	878
Other decapod species	879
Malacostraca as assay and food organisms	880
Malacostraca: conclusions	881
(11) Mollusca	884
(a) Gastropoda	885
Rearing of larvae	885
Fertilization, incubation and hatching	885
Environmental and nutritional requirements	886
Metamorphosis and setting	895
Rearing of juveniles and adults	895
Gamete maturation	897
Gamete release	898
(b) Bivalvia	900
Rearing of larvae	903
Fertilization, incubation and hatching	903
Environmental and nutritional requirements	904
Antibiotic treatment	916
Metamorphosis and setting	917
Rearing of spat	921
Rearing of juveniles and adults	923
Maintenance of a breeding stock	924
Gamete maturation	924
Gamete release	925
<i>In situ</i> cultures	928
Bottom cultures	928
Off-bottom cultures	929
Predators, competitors, parasites and poison producers	931
(c) Mollusca as assay and food organisms	934
(d) Mollusca: conclusions	934
(12) Echinodermata	936
(a) General aspects	936

CONTENTS

xiii

(b) Rearing of larvae	938
Fertilization, incubation and hatching	938
Environmental requirements	941
Nutritional requirements	942
(c) Rearing of juveniles and adults	943
Environmental requirements	943
Nutritional requirements	944
Gamete maturation and release	954
Natural breeding	955
Artificially induced breeding	960
(d) Echinodermata as assay and food organisms	965
(e) Echinodermata: conclusions	966
(13) Pisces	968
(a) General aspects	968
(b) Rearing of larvae	968
Fertilization, incubation and hatching	968
Critical period	971
Environmental requirements	972
Nutritional requirements	974
Type of food items	975
Size and structure of food items	981
Concentration of food items	981
Food selectivity	986
Starvation	987
Behaviour	988
Insufficient or abnormal stimuli	988
Schooling	989
Prey catching	991
Prey-catching process	991
Prey-catching success	994
Reactive perceptive field	995
Volume of water searched	997
Antibiotic treatment	997
(c) Rearing of juveniles and adults	1004
Environmental requirements	1004
Nutritional requirements	1005
Dietary composition	1008
Protein and amino acids	1013
Carbohydrates and fats	1016
Minerals and vitamins	1016
Food ration and feeding schedule	1018
Gamete maturation and release	1020
Natural breeding	1021
Artificially induced breeding	1023
Storage of spermatozoa	1029
Genetic recombination and stock improvement	1029

(d) Pisces as assay and food organisms	1032
(e) Pisces: conclusions	1033
(14) Mammalia	1035
(a) General aspects	1035
(b) Capture	1036
Pinnipeds	1037
Odontocetes	1037
Rules	1042
(c) Transport	1043
Pinnipeds	1044
Odontocetes	1045
Rules	1049
(d) Adjustments to captivity	1050
The beginning of odontocete cultivation	1053
Longevity	1054
Aggressiveness	1054
Training	1059
Experimentation	1060
Skin shedding	1060
Antibiotics	1062
(e) Environmental requirements	1063
Culture enclosure: minimum standards	1063
Culture enclosure: examples of exhibits	1067
Culture-water quality	1069
Water-treatment standards	1071
Temperature	1072
Salinity	1075
Disinfection	1077
Chlorination	1077
Application of copper	1081
Application of aluminium	1081
(f) Nutritional requirements	1082
Food storage	1083
Vitamins	1085
Force feeding	1087
Daily ration	1090
Feeding schedule	1092
Non-digestible items swallowed	1092
Feeding pinnipeds	1093
Adults	1093
Suckling juveniles	1104
Feeding odontocetes	1108
Adults	1108
Suckling juveniles	1111
Rules	1114

CONTENTS

xv

(g) Reproduction	1115
Pinnipeds	1118
Odontocetes	1121
(h) Mammalia: conclusions	1121
Literature cited	1124
Author Index	1231
Taxonomic Index	1255
Subject Index	1287

CONTRIBUTOR
TO
VOLUME III, PART 2

KINNE, O.,

*Biologische Anstalt Helgoland (Zentrale), Palmaille 9, 2000
Hamburg 50, Federal Republic of Germany.*

CULTIVATION

5. CULTIVATION OF ANIMALS

5.1 RESEARCH CULTIVATION

O. KINNE*

(1) Introduction

Cultivation is the most important analytical tool for the ecologist (Chapter 1). Together with descriptive and experimental field work it constitutes the fundament of ecological research. There is great need for cultivation experiments to be designed in ecologically meaningful terms. Numerous organisms have been cultivated under conditions utterly inadequate for solving ecological problems. This chapter is intended as a documentation of the state of the art of marine-animal research cultivation, as an attempt to define essential principles, and as a contribution towards providing a more solid basis for the field of marine ecology.

The literature on research cultivation of marine and brackish animals is vast and widely scattered—in fact, most experiments conducted on aquatic animals involve aspects of cultivation. The culture methods applied depend on the animal concerned, as well as on the perspective and aim of the investigator. Three principal aspects of research cultivation can be distinguished:

(i) **The fundamental aspect** employs cultivation as a tool for solving problems of basic research. For the experimental ecologist, the most important problems are: (a) assessment of organismic performance (e.g. growth, reproduction, behaviour) in relation to environmental change; (b) analysis of intra- and inter-specific dynamics; (c) elaboration of principles and rules of organismic coexistence; (d) establishment of nutritional requirements; (e) investigation of life cycles, taxonomy and evolutionary trends; (f) exploration of essential functions and structures of multispecific living systems.

(ii) **The assay-organism aspect** focuses on providing organisms with defined genetic and environmental backgrounds for assaying water quality (e.g. in pollution research) or biological processes (e.g. in biochemistry). Assay organisms must be easy to cultivate under reproducible conditions. Ideally, they should be: sensitive to environmental change; genetically well definable; small in body size, with high growth rates and short generation times; and capable of completing their whole life cycle under the conditions provided. For assaying the quality of natural waters, they should, in addition, be representative of the ecosystem or trophic level examined.

(iii) **The food-organism aspect** concentrates on mass production of food for animals to be cultured. Thousands of organisms qualify as potential food sources. However, large-scale mass cultures have their own problems. Demand for controlled, reproducible nutritional quality and for simple, inexpensive but reliable procedures

*Dedicated to my teachers Prof. Dr. H. FRIEDRICH and Prof. Dr. A. REMANE.

reduces the long list of potential food organisms to a few hundred. Among these, only a few dozen 'standard' food organisms have been used in most culture projects. Most of the standard food organisms belong to the following groups: bacteria, phytoplankton and other plants, protozoans, rotifers, branchiopods and copepods. In addition, eggs, larvae or tissue pieces of a variety of invertebrates (e.g. crustaceans, molluscs, echinoderms) and fishes have been used as food sources for animals sustained in culture. In some cases, tissues of birds and mammals have also been used. Although non-living food (preferably in the form of pellets with a long shelflife) is very convenient and has increasingly attracted the culturist's attention, some marine animals appear to require live or freshly killed food—at least certain compounds which are apparently too delicate to remain intact for long outside the protection of living cells. Ideally, food organisms should be euryplastic, easily digestible, of high nutritional value and readily mass producible.

The majority of the papers at hand on animal research cultivation are related to the fundamental aspect. The role of marine animals as assay and food organisms is briefly evaluated at the end of each taxonomic group treated. Only in very few cases is our present knowledge on the biology and ecology of marine animals sufficient for the design of specific, highly controlled and highly effective culture systems. Detailed information on the techniques used and on the diets offered is a prerequisite for analysis of the results obtained and for a sound comparison of the culture methods employed. Unfortunately, many investigators have failed to present such information in their papers. In complex culture operations, computer programmes handling all major parameters and system engineering will become a must for maximum success and efficiency.

Of basic importance for breakthroughs in aquatic animal cultivation are: (i) knowledge of environmental and nutritive requirements of the organisms sustained; (ii) timing of changes in environment and nutrition concurrent with changes in growth and/or developmental stage or physiological state; (iii) water-quality management; (iv) culture-system design (i.e. material, shape and size of essential system components); (v) assessment and control of the system's carrying capacity; (vi) avoidance or counteraction of disease; (vii) reconstitution of essential ecosystem characteristics regarding the flow of energy and matter.

Behavioural aspects are of importance, especially in 'higher' animals such as crustaceans (p. 742), fishes (p. 968) or mammals (p. 1035). In general, the importance of behavioural aspects tends to increase with the degree of functional and structural complexity of the animal concerned. In order to produce ecologically valid data, the culture environment must allow typical behaviour to develop. Otherwise the animals sustained may differ significantly from those in the field and fail to respond normally to environmental stimuli. Impoverished, excessive or unnatural sensory inputs can lead to abnormal behaviour, especially when effective during periods of maximum sensitivity (e.g. in larvae or subadults, or during reproduction). We must pay more attention to: shape, size and colour of the culture enclosure; social structures; illumination; environmental variation required as a function of age or physiological state; seasonal and other rhythms; the kind of substratum offered; and to specific stimuli that may be required for normal development.

Chemical substances such as pheromones may be important in sexual behaviour (RYAN, 1966; ATEMA and ENGSTROM, 1972), for correlations between offspring

and brooding females (e.g. LITTLE, 1975), and for substratum affinity of benthic forms. In the hermit crab *Clibanarius zebra*, certain tactile experiences of the larvae appear to constitute a prerequisite for proper coordination of behavioural steps involved in shell entry (HAZLETT, 1971): glaucothoe larvae without specific experience with gastropod shells managed to enter the shells when reared in a tactile-rich environment (e.g. sand grains), but, when brought up in a tactile-poor environment, most larvae failed to enter a shell correctly the first time (see also REESE, 1963; HAZLETT and PROVENZANO, 1965). Fish larvae reared in tanks may often suffer from stimuli input inadequate for normal development of sensory functions and structures. For commercial cultivation, less rigid requirements prevail unless seedlings are produced for recruitment of natural populations. In the latter case, the cultivated animals must be prepared to respond properly to essential cues they will encounter after release (e.g. predators, competitors, natural prey).

Insufficient parallelism between environmental conditions offered in cultures and those typical of the natural habitat may critically reduce the potential of the data obtained for analyzing and interpreting ecological *in situ* dynamics. Many animals have been cultivated at population densities considerably higher than those prevailing in nature. In numerous cases, environmental and nutritive circumstances have differed appreciably from those recorded at sea. It is doubtful whether data obtained under such conditions are ecologically meaningful. Narrow confinement and inadequate environmental and nutritive conditions tend to increase the cultivated animals' susceptibility to pathogens such as viruses, bacteria or fungi and to parasites (KINNE (in press)). Cleanliness and disinfection of equipment, culture water and food—best achieved in closed culture systems—are the major counter measures against infectious diseases in cultures. Deficiency diseases can be controlled by adequate nutrition. Healthy, normally performing animals are a prerequisite for ecological analyses. Experimental ecologists must produce data on organismic performances that can be extrapolated with a reasonable degree of reliability to the situation prevailing in the sea.

Benthic and planktonic animals usually require different culture methods. Several benthic animals can be cultured successfully in simple containers, such as Petri or Boveri dishes (Fig. 2-23, p. 58), without continuous water-quality management; some reproduce in stagnant sea water, replenished at intervals—providing temperature and food are adequate and the ratio surface to volume of the water body is sufficiently large. In contrast, most planktonic animals require water movement; at the same time, they must be protected from excessive physical contact with solid materials or air bubbles. Numerous marine animals are stenoplastic and are very susceptible to variations in water quality; others exhibit specific nutritive requirements; in both cases, cultivation involves considerable efforts in terms of culture-water management and technology (Chapter 2).

As a general rule, marine animals with direct development are easier to cultivate than those with life cycles involving larval stages. Among the forms with larval stages, the difficulties tend to increase with the length of the larval period and with the number of larval instars.

Analyses of variations in genetic and non-genetic components of natural populations of marine animals are being conducted in several laboratories. Employing cultivation as a major tool, such studies facilitate new insights into genetic aspects

of ecology and provide a basis for selective breeding. In some branches of research cultivation (e.g. the production of food organisms or in genetical analysis) and in commercial cultivation (stock improvement), selective breeding contributes significantly to success. However, this far, selective breeding has been possible only in very few marine animals, and its economic importance is a long way from matching comparable achievements in domesticated terrestrial animals.

Through effluent release, large commercial culture systems may affect the coastal environment. For avoiding or reducing critical impacts, as well as for facilitating maximum efficiency in culture-water management, closed systems offer the best possibilities. Recycling systems in which organic wastes, produced by the animals cultured or by human populations, serve as nutritional basis for the phytoplankters which, in turn, are consumed by the cultured animals feature important advantages: They reduce or eliminate environmental pollution due to waste-water release, and they continuously provide most or all of the nutrients required by the primary producers. Sterilization of the waste water prior to entry into the system can be effected by flow-through, ultra-violet irradiation units (Chapter 2, p. 163).

The provision of nutrients for cultured animals has entered a new phase. Never before has so much emphasis been placed on the search for adequate, cheap, easy-to-handle, qualitatively defined and reproducible food. As in many other fields of animal cultivation, the primary driving forces are commercial rather than ecological. While the ecological significance of nutritional requirements and nutritional strategies remains to be explored in depth, the development of feeds designed to maximize meat production of crustaceans, molluscs and fishes proceeds at a breathtaking speed. An interesting theory of feeding strategies has been presented by SCHOENER (1971).

For cultivation purposes, large amounts of nutrient-rich, high-quality, cold sea water have been made available by pumping deep sea water to the surface. Such 'artificial upwelling' has been pioneered in the USA (e.g. GERARD and ROELS, 1970; ROELS and GERARD, 1970; BAAB and co-authors, 1973; ROELS, in press; ROELS and co-authors, in press; SUNDERLIN and co-authors, in press). In St. Croix, ROELS and co-authors pumped Antarctic Intermediate Water continuously from a depth of 870 m into 45,000 shore-based, concrete pools, in which they grew cultures of planktonic diatoms. Each day, their system produced 113,550 l of nearly uni-algal diatom culture (10^4 to 10^6 cells ml^{-1}), pumped continuously into tanks containing oysters, scallops and clams. In the effluent water of the mollusc tanks, spiny lobsters, queen conch and carrageenin-producing seaweeds were grown. It is planned to initiate large-scale operations utilizing (i) the deep sea water's low (5° to 7° C) temperature (e.g. power generation by the Claude process, desalination, air conditioning), and (ii) the water's fertilizing potential for large-scale aquaculture projects. According to ROELS and co-authors, a 100-MW 'sea-thermal power plant' would require a flow of 4.5×10^7 l of deep water min^{-1} . Such a water flow is expected to yield 125,000 tons of mollusc meat and 59,000 tons (dry weight) of carrageenin-producing seaweed each year. However, the operation of such a system would be restricted to special areas. Its economy remains to be demonstrated.

As is well known, in the marine food web, the major route of energy and matter passes from unicellular primary producers through small filter-feeding zooplankters to larger predators. Accordingly, most marine animals sustained in culture have

been fed either phytoplankters or zooplankters. To rear these organisms is usually a time-consuming, expensive proposition.

A new aspect in the provision of food for particulate feeders is micro-encapsulated diets. Advocated by MEYERS and co-authors (1971) and ANONYMOUS (1973a), and explored further by JONES and co-authors (1974, and in press), JONES and GABBOTT (1976), as well as by GABBOTT and co-authors (in press), micro-encapsulated diets for animals which do not depend on living food promise advantages: (i) easy mass production, (ii) known or largely known diet composition, (iii) high reproducibility in quality, (iv) defined particle size, and (v) convenient handling and storage. Employing a method described by CHANG and co-authors (1966), JONES and GABBOTT produced microcapsules consisting of an internal aqueous phase incorporating the diet, with a nylon-protein wall. Liquid or semi-solid diets contained in microcapsules have been used for sustaining *Artemia salina* (JONES and co-authors, 1974) and *Macrobrachium rosenbergii* (JONES and co-authors, in press). Microcapsules, as well as the larger capsules used for some time in fish culture, must account for the feeding behaviour and feeding mechanism of the cultured animal and be sufficiently resistant to dissolution and rapid bacterial breakdown. A good diet should include the following characteristics: (i) meet all nutritional requirements of the animals cultivated; (ii) be inexpensive, readily available, digestible, and reproducible in quality; (iii) have sufficient water stability and a long storage life (see also pp. 915, 979, 1373).

Detritus feeders utilize non-living particulate matter, but usually obtain essential substances also from the microflora attached to the detritus particles. In nutritional studies, source, size and chemical composition of the particles consumed must be considered, as well as the attached micro-organisms.

Sea water used for cultivation must be carefully collected: (i) far out to the sea in unpolluted areas; (ii) preferably, or obligatorily, from the water body from which the animals to be cultivated have been obtained; (iii) from the bow of the ship to prevent pollution due to substances released from the ship; (iv) in a glass bottle or in a bucket of suitable, non-toxic material. For details on sea water as culture medium see pp. 20 to 37, on sea-water storage, pp. 24 to 29, on culture-water treatment, pp. 100 to 166, and on chemical contamination of culture media, Chapter 7.

This subchapter concentrates on animal groups which have received appreciable attention from experimental ecologists and culturists: Protozoa, Porifera, Cnidaria, Turbellaria, Rotifera, Nematoda, Bryozoa, Annelida, Crustacea, Mollusca, Echinodermata and Pisces; marine mammals—maintained in zoos, delphinaria or oceanaria—are also briefly considered. While the protozoans, the lower invertebrates and the crustaceans required detailed documentation due to the often rather specific methodology employed and the wide range of different body plans represented, in molluscs, echinoderms and fishes, it was possible to emphasize increasingly the principles involved in cultivation and to document these by referring to a few, selected examples rather than to attempt exhaustive treatment.

Within each of the animal groups reviewed, most genera and species are treated in alphabetical order. In Protozoa and in some of the lower invertebrates, reference is made to axenic cultures. A special account on axenic cultivation is provided in Chapter 5.11. Axenic cultivation of multicellular animals has been attempted in a few invertebrates, mammals and birds. Thus far, no metazoan can be sustained

indefinitely on a holidic medium under axenic conditions. For general accounts concerned with or related to research cultivation of aquatic animals consult ALLEN and NELSON (1910), ABDERHALDEN (1933), HAGMEIER (1933), NEEDHAM (1937), HAUENSCHILD (1962, 1968, 1970), KINNE and AURICH (1967), SCHLIEPER (1968), COSTLOW (1969), CONOVER (1970), KINNE and BULNHEIM (1970), and SMITH and CHANLY (1975).

(2) Protozoa

Thousands of publications on Protozoa include aspects of cultivation. However, less than some 5% of these papers are immediately related to ecology. Most of the available information has been obtained under 'unnatural' environmental and nutritive conditions. The light, temperature, ionic or pressure regimes offered had often little in common with normal habitat conditions.

The majority of protozoologists have concerned themselves with limnic forms and have favoured such fields as physiology, biochemistry, immunology, genetics and parasitology. While admirable physiological and biochemical details have become known, the lack of ecologically oriented results is deplorable. Our present knowledge on organism–environment and organism–organism relations in marine protozoans is unsatisfactory and insufficient for a critical assessment of the presumably fundamental role which these organisms play in natural multispecies systems.

A number of protozoans have been cultivated under axenic conditions. In view of the importance of axenic cultures for investigating detailed nutritional requirements and for developing chemically defined media, a special subchapter (5.11) in this volume has been devoted to axenic techniques. However, brief treatment of axenic cultivation is also necessary in the present context.

How does axenic cultivation fit into ecological concepts? There is no readily available answer to this question. Much can be said for and against cultivation under axenic conditions. While the pros are easily appreciated, the cons should not be taken lightheartedly. They come from ecologists who question the applicability of information obtained under extremely artificial conditions for interpreting biological phenomena in oceans and coastal waters. DROOP (1970, p. 272) puts it in a nutshell:

'... this approach affords the most direct and most critical means of establishing absolute nutritional requirements, both from a qualitative and quantitative point of view. The interpretations, ecological or otherwise, of findings from axenic cultures must necessarily be open to debate, but this does not affect the primary function, and indeed success, of the axenic method, namely of defining nutritional needs in chemical terms.'

Axenic cultivation is essential in vitamin research and important in the analysis of interspecific relationships, but it is neither the only, nor the ultimate, method for analyzing organismic requirements. The results obtained with this method must be evaluated in the light of, and in context with, information produced by other laboratory techniques and by field studies.

Investigations into the nutritional requirements of Protozoa frequently follow a set pattern (DROOP, 1970): (i) monoxenic cultivation with an obligately phototrophic alga as food source; (ii) axenic cultivation after finding a substitute for the

living food alga (sometimes it may be difficult, or even impossible, to find a substitute for living food: metabolic intermediates may be required which are too labile to exist for long outside a living cell); (iii) identification of the water-soluble nutrient requirements; (iv) identification of the fat-soluble nutrient requirements. Isolation and purification of protozoan cultures are effected by manipulative separation or by applying antibiotics—sometimes by a combination of these two methods.

In protozoans, three main types of food intake can be distinguished (Volume II: PANDIAN, 1975): (i) osmotrophy: food absorption through the external cell surface; (ii) pinocytosis: surface-vesicle formation followed by vesicle invagination; (iii) phagocytosis: solid-particle uptake. These three types are neither mutually exclusive nor sharply separable. Few protozoans have been cultivated in the absence of particulate food. Some forms known or assumed to be primarily particle feeders under field conditions have been acclimated to live in particle-free media. Both obligate and facultative osmotrophs lend themselves for studies, under exactly defined environmental and nutritive conditions, on metabolic performance and as bioassay organisms (p. 620).

We concentrate here on heterotroph free-living forms. Autotroph unicells are treated in Chapter 4.1; for protozoan parasites of importance to marine ecologists, consult LAUCKNER (in press). Axenic cultures and specific nutritional requirements of protozoans are covered in detail in Chapter 5.11.

Among the pioneers who have cultivated free-living protozoans, PRINGSHEIM deserves special mention. His ability and genius to find, isolate and grow protozoans and to search for suitable culture media has contributed essentially to the present-day fundament of Protozoa cultivation.

'Only a combination of a naturalist and a physiologist, kindled by impatience to know, tenacity and a green thumb could have achieved such results...

PRINGSHEIM has brought to the attention of all of us group after group of interesting and neglected organisms, guiding us with his sure hand' (PROVASOLI and GOLD, 1962, p. 196).

Of the reviews and books published on cultivation of heterotroph protozoans, we list here: KIRBY (1950), KIDDER (1951, 1967), JOHNSON (1956), MAYER (1956), PROVASOLI (1958), NEEDHAM (1937), MACKINNON and HAWES (1961), HUTNER (1962) and HALL (1967). CORLISS (1973b) has briefly assessed the present status of protozoan ecology.

(a) Zooflagellates

Acanthoecopsis sp. and *Diaphanoeca grandis*

Acanthoecopsis sp. and *Diaphanoeca grandis*, two brackish-water choanoflagellates, have been cultivated axenically in semi-defined basal media by GOLD and co-authors (1970; see also p. 1306).

Isolation and purification. The two choanoflagellates were isolated after having been grown as 'contaminants' in cultures of *Tintinnida*. Prior to purification with antibiotics, they were established in bacterized medium DVLA (Table 5-1). The low concentrations of organic substances in this medium permitted limited bacterial

Table 5-1

Medium DVLA. A simple, organically enriched, bacterized medium for cultivating the choanoflagellates *Acanthoecopsis* sp. and *Diaphanoeca grandis* (After GOLD and co-authors, 1970; reproduced by permission of Society of Protozoologists)

Component	Amount	Component	Amount
NaCl	18 g	B ₁₂	1 µg
MgSO ₄ ·7H ₂ O	5 g	Biotin	1 µg
KCL	0.6 g	Thiamine	1 mg
Ca (as Cl)	0.1 g	Liver concentrate (1:20)	40 mg
NaNO ₃	0.5 g	Na acetate (anhydrous)	0.2 g
K ₂ HPO ₄	30 mg	'Tris'	1 g
Na ₂ SiO ₃ ·9H ₂ O	0.2 g*	Distilled H ₂ O	1 l
Metals mix	1 ml†	pH before and after autoclaving:	7.5 to 7.8

*To assure solution, silicate is added to a portion of the distilled H₂O used to prepare the medium. It is then acidified with a few drops of concentrated HCl, shaken vigorously and added to the remainder of the solution.

†1 ml Metals mix contains: Na₂ EDTA, 10 mg; FeCl₃·6H₂O, 0.5 mg; H₃BO₃, 10 mg; MnCl₂·4H₂O, 1.5 mg; ZnCl₂, 0.1 mg; CoCl₂·6H₂O, 0.05 mg.

Table 5-2

Medium C₃. A highly enriched, semi-defined, axenic basal medium for cultivating the choanoflagellate *Acanthoecopsis* sp. (After GOLD and co-authors, 1970; reproduced by permission of Society of Protozoologists)

Component	Amount	Component	Amount
NaCl	18 g	Vitamin mix 8	1 ml‡
MgSO ₄ ·7H ₂ O	5 g	Na acetate (anhyd.)	1 g
KCl	0.6 g	Na pyruvate	30 mg
Ca (as Cl)	0.1 g	Dextrose	250 mg
NaNO ₃	0.5 g	Proteose peptone	500 mg
K ₂ HPO ₄	30 mg	Liver concentrate (1:20)	40 mg
Na ₂ SiO ₃ ·9H ₂ O	0.2 g*	Tris	1 g
Metals mix	1 ml†	Distilled H ₂ O	1 l
B ₁₂	1 µg	pH before autoclaving:	7.8
Biotin	1 µg	pH after autoclaving:	7.6-7.8
Thiamine	1 mg		

*See footnote *, Table 5-1.

†See footnote †, Table 5-1.

‡PROVASOLI and co-authors (1957).

growth, thereby providing sufficient food, but preventing bacterial overgrowth. Higher cell yields were obtained with *Acanthoecopsis* sp. than with *Diaphanoeca grandis*, and the former appeared to be more tolerant to antibiotics. Consequently, *A.* sp. was purified first. The purification procedure consisted of serial transfers

over a 1.5 month period in DVLA or DVLA + 20% medium STP (PROVASOLI and co-authors, 1957), with rather high concentrations of antibiotics: penicillin, 300 units ml⁻¹; streptomycin, 300 µg ml⁻¹; sodium novobiocin, 20 to 40 µg ml⁻¹.

Sustenance. The basal medium C₃ developed for *Acanthoecopsis* sp. is listed in Table 5-2. Cultures were maintained under a photoperiod of 18 hrs light at 10° C. Both choanoflagellates can be grown in complete darkness; they are strict heterotrophs. Culture containers were 125- × 20-mm screw-cap test tubes. Ten ml of medium prepared from reagent grade chemicals were added to each test tube and then sterilized (15-min autoclaving at 121° C.) Transfers every 2 to 3 weeks were sufficient to keep the cultures in good condition. Periodic phase-contrast microscopy revealed only loricate individuals with the characteristic structure of each species.

Table 5-3

Modified version of DROOP's (1958) medium S50 used for cultivating the dinoflagellate *Amphidinium höfleri* (After ELBRÄCHTER, 1972; reproduced by permission of Institut für Meereskunde, Kiel)

Component	Amount
NaCl	15 g l ⁻¹
MgCl ₂ .6H ₂ O	2.5 g l ⁻¹
KCl	400 mg l ⁻¹
CaSO ₄ .2H ₂ O	500 mg l ⁻¹
KBr	22 mg l ⁻¹
SrCl ₂ .6H ₂ O	3.8 mg l ⁻¹
AlCl ₃	28 µg l ⁻¹
RbCl	61 µg l ⁻¹
LiCl	6 µg l ⁻¹
FeCl ₃ .6H ₂ O	500 µg l ⁻¹
MnCl ₂ .4H ₂ O	50 µg l ⁻¹
ZnCl ₂	5 µg l ⁻¹
CuSO ₄	5 µg l ⁻¹
NaNO ₃	100 mg l ⁻¹
K ₂ HPO ₄	10 mg l ⁻¹
Na ₂ EDTA	50 mg l ⁻¹
B ₁₂	100 mµg l ⁻¹
Biotin	100 mµg l ⁻¹
Thiamine	1 mg l ⁻¹
pH 7.5 after autoclaving	

Amphidinium höfleri

Axenic populations of the dinoflagellate *Amphidinium höfleri* thrive on added dissolved amino acids. ELBRÄCHTER (1972) cultivated *A. höfleri* in a modified version of DROOP's (1958) medium S50 (Table 5-3), employing inorganic chemicals

of p.a.-grade and organic substances of biochemical grade in 120-ml glass bottles (illumination: 870, 485 or 270 lux; photoperiod: 12 hrs light; 16.0° C). In order to test the effects of amino acids, the culture medium contained only 200 $\mu\text{g l}^{-1}$ NaNO_3 (instead of 100 mg l^{-1} ; Table 5-3), but was enriched with glycine, glycylglycine or L-valine. Each culture was tested for absence of bacteria. The dissolved amino acids listed tend to increase the cell volume by about 6% if offered at a concentration of 50 mg l^{-1} (generation time remains unchanged), indicating limited heterotrophy. If offered in concentrations of 200 $\mu\text{g l}^{-1}$, i.e. in natural concentrations, no growth-promoting effect could be established. While *A. höffleri* is a chromatophore-bearing phototroph, its capacity for heterotrophic amino-acid uptake is of interest in the present context.

Cryptocodinium cohnii

First brought into culture by KÜSTER (1908) and PRINGSHEIM (1956), the euryhaline, colourless, osmotrophic heterotroph dinoflagellate *Cryptocodinium cohnii* (syn.: *Gyrodinium cohnii*) has been grown by PROVASOLI and GOLD (1962) under axenic conditions to high population densities (4 million cells ml^{-1}) in 7 days; for details consult p. 1301.

Isolation and purification. Three strains were collected from rotting *Fucus*. The accompanying microflora was eliminated in three steps in artificial sea water III Medium (PROVASOLI and co-authors, 1957, p. 401), enriched with sodium acetate. $3\text{H}_2\text{O}$, 100 $\text{mg}\%$ + yeast digest,* 1 ml 100 ml^{-1} and Tris, 0.1%: (i) Inoculation in above mentioned medium + 'AM 7' antibiotic mixture for 5 days (final concentration ml^{-1} : K penicillin G, 2000 units; chloramphenicol, 60 μg ; neomycin, 60 μg ; polymixin B sulphate, 60 units). (ii) To eliminate the yeast, a few drops of the culture were inoculated into fresh medium + 6 units ml^{-1} of candicidin. (iii) Bacteria-free cultures were obtained by transferring a few drops into a medium with a more complete antibiotic mixture and candicidin (final concentration ml^{-1} : K penicillin G, 500 units; chloramphenicol, 5 μg ; neomycin, 25 μg ; polymixin B, 15 units; dihydrostreptomycin, 500 μg ; tetracycline, 25 μg ; candicidin, 15 units) and by letting the culture grow for 15 days. Bacteria-free cultures have also been obtained by 15 micropipette washings in sterile media direct from the crude culture, or by 5 washings a day after inoculation when both bacteria and yeast were very scarce. The high resistance of *C. cohnii* to antibiotics and candicidin may also be typical of other protozoans inhabiting polluted waters.

Sustenance. *Cryptocodinium cohnii* has been sustained successfully in SW Ph II medium: sea water, 75 ml; H_2O , 15 ml; Pringsheim yeast digest, 10 ml; proteose peptone (Difco), 10 mg; polypeptone, 10 mg; Na acetate. $3\text{H}_2\text{O}$, 50 mg; glucose, 50 mg; vitamin mix no. 8, 0.05 ml; Na_2 EDTA, 2 mg; Tris buffer, 0.1 g; pH 7.6–7.8. Glucose, glycerol and acetate are the best carbon sources; the combination of two or three C-sources yields better growth than any single source. Biotin is needed. Thiamine is probably synthesized but at a low rate: absence of thiamine results in continued slow growth; addition of thiamine gives dense, rapidly growing populations. *C. cohnii* tolerates high concentrations of Tris buffer.

* Place 100 g of fresh baker's yeast in 1 l H_2O for 6 hrs at 50° C; put overnight in refrigerator; centrifuge well. The supernatant is milky with millions of fine particles of bacterial size.

The growth requirements of *Cryptocodinium cohnii* (Puerto Rico strain) have been examined further by GOLD and BAREN (1966; see also p. 1302). These investigators found the optimum temperature for 72-hr bioassays to be 30° C (20° and 35° C cause inhibition of population growth); they recommend the medium listed in Table 5-4. A variety of mixtures of amino acids was tested along with vitamin B₁₂ and other vitamin supplements as substitutes for natural products to permit growth at 35° C. The most satisfactory amino-acid mixture contained L-proline,

Table 5-4

Basal medium for cultivating *Cryptocodinium cohnii*. 30° C. Yield: 2000 cells mm⁻³ within 4 days (After GOLD and BAREN, 1966; reproduced by permission of Society of Protozoologists)

Artificial sea water*	Enrichment (added to 1 l artificial sea water)		
g l ⁻¹		mg l ⁻¹	
NaCl	23.48	Metal mixture†	3
MgCl ₂ · 6H ₂ O	10.63	FeCl ₃ · 6H ₂ O	10
Na ₂ SO ₄	3.92	Na ₂ glycerophosphate · 5½ H ₂ O	150
CaCl ₂ (anhyd.)	1.11	K ₂ HPO ₄	10
KCl	0.66	Glucose	3000
NaHCO ₃	0.19	Glutamic acid	1500
KBr	0.1	(NH ₄) ₂ SO ₄	50
H ₃ BO ₃	0.03	Biotin	10 ⁻³
SrCl ₂ · 6H ₂ O	0.04	Thiamine	1
		Tris (hydroxymethyl aminomethane)	3000
Distilled H ₂ O to 1 l		pH before autoclaving	6.4-6.6

*Modified after LYMAN and FLEMING (1940); see p. 30 for details.

†1 ml of metal mixture contains: Na₂ EDTA, 10 mg; FeCl₃ · 6H₂O, 0.5 mg; H₃BO₃, 10 mg; MnCl₂ · 4H₂O, 1.5 mg; ZnCl₂, 0.1 mg; CoCl₂ · 6H₂O, 0.05 mg.

hydroxy-L-proline, and DL-tryptophan. In the presence of vitamin B₁₂ and a vitamin supplement, L-proline and DL-tryptophan increased population growth markedly. Neither amino acid alone supported growth satisfactorily at 35° C.

KELLER and co-authors (1968) have made long-term mass cultivation of *Cryptocodinium cohnii* easier by developing: (i) biphasic media for prolonged conservation and provision of nutrient-depleted inocula; (ii) defined acidic basal media stored as frozen dry mixes; (iii) agar slants for prolonged conservation. Ten ml of agar butt were overlaid with 10 ml of solution in 150- × 25-mm screw-cap tubes. The solid phase consisted of media similar to that listed in Table 5-5 (some media contained glycerol, glycerophosphate or histidine) solidified with 0.6% agar. On agar slants, fast growth was obtained. From a single-line streak, the population spread, at about 25° C, over the slant, heaping as yellowish-white blobs. Slants stored at about 6° C remained viable for at least 6 months. Trace elements were supplied from a dry mix to yield (mg 100 ml⁻¹ of medium): Fe, 0.25 as Fe(NH₄)₂(SO₄)₂ · 6H₂O;

Mn, 0.2 as $\text{MnSO}_4 \cdot \text{H}_2\text{O}$; Zn, 0.2 as $\text{ZnSO}_4 \cdot 7\text{H}_2\text{O}$; Mo, 0.08 as $(\text{NH}_4)_6\text{MoO}_{24} \cdot 4\text{H}_2\text{O}$; Cu, 0.016 as CuSO_4 (anhydrous); V, 0.008 as NH_4VO_3 ; Co, 0.004 as $\text{CoSO}_4 \cdot 7\text{H}_2\text{O}$; B, 0.004 as H_3BO_3 ; Cr, 0.004 as $\text{CrK}(\text{SO}_4) \cdot 12\text{H}_2\text{O}$; Ni, 0.004 as $\text{NiSO}_4 \cdot 6\text{H}_2\text{O}$. This trace-element supply may seem unusually high. However, several protozoans have been shown to exhibit exaggerated requirements for trace elements at supraoptimal temperatures (HUTNER and co-authors, 1958).

The optimal growth medium developed by TUTTLE and LOEBLICH (1975) for *Cryptocodinium cohnii* consists of NaCl, 342 mM; MgSO_4 , 28 mM; CaCl_2 , 7.5 mM; KCl, 9 mM; disodium glycerophosphate, 0.79 mM; $(\text{NH}_4)_2\text{SO}_4$, 1.5 mM; sodium acetate, 15 mM; L-histidine.HCl, 0.8 mM; biotin, 8.2×10^{-9} M; thiamine.HCl, 2.96×10^{-6} M, vitamin B_{12} , 7.49×10^{-10} M; D-glucose, 22 mM; betaine.HCl,

Table 5-5

Solid phase of simple agar-slant medium (weight 100 ml⁻¹ of medium) for *Cryptocodinium cohnii* (After KELLER and co-authors, 1968; reproduced by permission of Society of Protozoologists)

K_3 citrate. H_2O	0.1 g	DL-Alanine	0.01 g
KH_2PO_4	0.01 g	Betaine HCl	0.01 g
MgSO_4 (anhydrous)	0.35 g	Trace elements	(see text)
KCl	0.08 g	Sucrose	0.1 g
NaCl	3.0 g	Glucose	0.5 g
CaCO_3 (= Ca 0.02 g)	0.05 g	Nitilotriacetic acid	2.0 mg
NH_4Cl	0.008 g	Thiamine HCl	0.05 mg
L-Glutamic acid	0.1 g	Biotin	0.2 μg

Adjust pH to 6.0 to 6.2 with Tris. Then add agar, 1.5 g, and autoclave. CaCO_3 was later replaced by soluble Ca succinate. H_2O .

9.7 mM; MES, 8 mM; F metal mix (100 \times stock solution contains: nitilotriacetic acid, 6 mM; 5-sulphosalicylic acid, 0.08 mN; $\text{Fe}(\text{NH}_4)_2(\text{SO}_4)_2$, 0.18 mM; NaOH, 30 mM; pH to 3.8 with HCl), final medium pH = 6.6. Optimal growth (3 divisions day⁻¹) requires darkness. The temperature optimum for binary fission is 27° C; optimum pH is 6.6. Culture-water agitation turned out to be inhibitory.

Noctiluca miliaris

The large, osmotrophic-phagotrophic dinoflagellate *Noctiluca miliaris* (syn.: *N. scintillans*) has been cultured by GROSS (1934), MCGINN and GOLD (1969), GOLD (1970), MCGINN (1971) and UHLIG (1972a). Its axenic cultivation receives detailed attention on p. 1304.

GROSS (1934) and UHLIG (1972a) mass-cultured *Noctiluca miliaris* in fine-filtered, pasteurized sea water, using glass dishes of different sizes as culture enclosures. The mass cultures were fed at intervals varying from 1 day to 1 week with *Dunaliella* sp. from pure cultures. At optimal nutritional conditions (no details given) and 20° C, UHLIG recorded one cell division per day. Under a natural day-night rhythm, dividing cells were most abundant at about 03.00 a.m.

MCGINN and GOLD (1969) and GOLD (1970) allowed newly collected *Noctiluca miliaris* to rise in a 1-l cylinder filled with sea water. The cells were then pipetted off the top and inoculated into sterile sea water. Initially, a mixture of phytoflagellates was offered as food. Later, the cultures received specimens of a single *Platymonas* species kept under axenic conditions. *N. miliaris* grows fastest at 20° C. Nutritional requirements (p. 1306) have been investigated in populations growing in darkness in a heat-sterilized, organically enriched medium. Bacteria-free cultures of *N. miliaris* were obtained by addition of antibiotic mixtures containing penicillin, streptomycin and novobiocin, in combination with the dilution technique. *N. miliaris* was then maintained monoxenically in synthetic sea water with *Platymonas* sp. as food source. Axenic cultivation was achieved following several weeks growth in darkness (p. 1306).

The heat-sterilized medium used to cultivate *Noctiluca miliaris* contained a mixture of water-soluble vitamins, glucose as carbon source, and RNA, DNA, casein and soil extract. Although the axenic cells behaved like their monoxenic predecessors, final cell yield remained below that obtained on live foods. Examples of final cell densities after 10 days are: monoxenic, 38 cells ml⁻¹; axenic, 16 cells ml⁻¹. Newly transferred *N. miliaris* reproduced by fission; budding occurred in older cultures. Both types of reproduction have been observed in one clone (MCGINN and GOLD, 1969).

Oxyrrhis marina

The ubiquitous dinoflagellate *Oxyrrhis marina* is a phagotrophic protozoan of voracious habit—an animal with a number of plant-like nutritional features (DROOP, 1970). It has been cultivated by BARKER (1935), DROOP (1953, 1958, 1959, 1963, 1966a), DROOP and DOYLE (1966) and DROOP and PENNOCK (1971). Axenic cultures are reviewed on p. 1303.

Isolation and purification. *Oxyrrhis marina* was isolated and purified by Pringsheim's washing method (DROOP, 1953). It grew well on any one of a variety of pure strains of unicellular algae (DROOP, 1966a). Use of the obligate phototroph *Nannochloris oculata* as initial food simplifies the passage to the next phase of cultivation: The culture has merely to be incubated in the dark in a suitable medium to eliminate the algal food. The medium for the first successful axenic cultures of *O. marina* contained 'a little' neutralized lemon juice as essential ingredient (DROOP, 1959).

Sustenance. Food organisms readily consumed by *Oxyrrhis marina* and basic nutritional requirements are listed on p. 1303. The lemon juice was later replaced by a quinone and a sterol. Ethanol solutions emulsify when added to culture media, and are a most satisfactory way of administering lipids. For the organic requirements of *O. marina*, consult DROOP (1959, 1970) and DROOP and PENNOCK (1971).

(b) Amoeba

FROSC (1897) and TSUJITANI (1898) were the first to report on methodological aspects of pure cultures of amoebae. Important early papers were published by VAHLKAMPF (1905), WÜLKER (1911), ARNDT (1922), OEHLER (1924) and REICH (1935, 1936).

Today, enrichment of large amoebae still follows original patterns. Individuals are selected with a micropipette from a raw culture and transferred into culture media (e.g. BELAR, 1928; KIRBY, 1950; MACKINNON and HAWES, 1961; SCHMOLLER, 1965). Small-sized protozoans, algae, metazoans and detritus particles serve as food (e.g. CHATTON, 1953; RAO, 1971). Small amoebae (20 to 30 μm) feed on bacteria and can be enriched and cultured on agar media. Free-living small amoebae are accumulated on straw decoction (boil 20 to 30 g straw in 1 l of water) and enriched on agar plates with heat-killed bacteria as food (SCHMOLLER and SCHWARZ, 1964; SCHMOLLER, 1965). **Pre-enrichment:** (i) decoction enrichment if amoebae are scarce; (ii) enrichment through putrefaction followed by slow desiccation if representatives capable of forming resistant cysts are to be selected; (iii) addition of 1 to 2 cm^3 peptone broth to 100 cm^3 of water sample for accumulating amoebae of the free water. **Enrichment on agar plates:** Agar plates (2% agar as sea-water agar) are, in their centre, inoculated with sea water containing amoebae. Following selective enrichment, single individuals are isolated and parallel pure cultures established. Transfer to plates with heat-killed bacteria is the next step. Finally, the search for particle-free, chemically defined nutritive media may begin.

Acanthamoeba griffini

The euryhaline amoeba *Acanthamoeba griffini* was cultivated on agar media by SAWYER (1971). SAWYER placed 6.5 ml of agar medium in 60-mm plastic dishes. Fresh plates were then streaked with *Aerobacter aerogenes*, and inoculated with amoebae and cysts on small blocks of agar from parent cultures. The culture medium contained agar, 1.5%; maltose, 0.01%, and yeast extract, 0.01%. It was prepared in distilled water or sea water and maintained at 22° to 25° C.

Table 5-6

Culture medium for sustaining *Heteramoeba clara*. 8‰S
(After DROOP, 1966a; reproduced by permission of Allen and Unwin, Ltd.)

Component	Amount
Soil extract	25 mg
KNO ₃	100 mg
K ₂ HPO ₄	10 mg
Thiamine	50 μg
Vitamin B ₁₂	100 $\text{m}\mu\text{g}$
Glycine	50 mg
Arginine	50 mg
CH ₃ COO Na	500 mg
Natural sea water	250 ml
Distilled water	750 ml

Table 5-7

Ability of alga strains to support population growth of *Heteramoeba clara*. Number of successful cultures (out of 10), examined after 4 days and again after 6 weeks. Algal-strain numbers refer to the Millport collection. Numbers in parentheses: maximum cell dimension (After DROOP, 1966a; modified; reproduced by permission of Allen and Unwin, Ltd.)

Food alga	Number of cultures containing amoebae	
	after 4 days	after 6 weeks
Volvocales		
<i>Brachiomonas submarina</i> , 42* (8-20 μ m)	8	9
<i>B. submarina</i> , 43 (8-20 μ m)	10	10
<i>B. submarina</i> var. <i>pulsifera</i> , 44 (8-20 μ m)	7	10
<i>B. submarina</i> var. <i>pulsifera</i> , 45 (8-20 μ m)	9	10
<i>Chlamydomonas pulsatilla</i> , 11 (10-30 μ m)	7	9
<i>C. pulsatilla</i> (var.), 120 (14-40 μ m)	8	9
<i>C. pulsatilla</i> (var.), 150 (14-70 μ m)	7	9
<i>C. pulsatilla</i> (var.), 151 (9-35 μ m)	9	9
<i>C. pulsatilla</i> (var.), 152 (14-42 μ m)	6	7
<i>C. pulsatilla</i> (var.), 153 (11-30 μ m)	8	9
<i>C. spreta</i> , 67 (4-10 μ m)	9	9
<i>C. spreta</i> , 68 (4-10 μ m)	10	10
<i>Dunaliella primolecia</i> , 57 (5-12 μ m)	7	7
<i>Tetraselmis carteriaformis</i> , 10 (12-14 μ m)	1	9
<i>T. tetrathele</i> , 9 (10-16 μ m)	0	8
<i>T. sp.</i> , 115 (7-12 μ m)	0	0
Bacillariophyceae		
<i>Thalassiosira</i> sp., 79 (1-8 μ m)†	2	5
<i>Phaeodactylum tricornutum</i> , 14 (14 μ m)	9	9
<i>P. tricornutum</i> , 15 (14 μ m)	10	10
<i>Skeletonema costatum</i> , 73 (4-100 μ m)‡	1	0†
Cryptophyceae		
<i>Hemiselmis virescens</i> , 64 (7 μ m)	7	9
Rhodophyceae		
<i>Porphyridium cruentum</i> , 70 (10 μ m)	5	6
Chlorococcales		
<i>Nannochloris oculata</i> , 66 (2-4 μ m)	0	3†
<i>N. sp.</i> , 105 (3-9 μ m)	0	0
<i>Chlorella ellipsoidea</i> , 116 (4-15 μ m)	0	0
Chrysophyceae		
<i>Apistonema</i> sp., 110 (14-35 μ m)	0	0
<i>Isochrysis galbana</i> , 58 (8-10 μ m)	0	0
<i>Monochrysis lutheri</i> , 60 (8-10 μ m)	0	0
<i>Cricosphaera elongata</i> , 62 (20-30 μ m)	0	0
<i>Prymnesium parvum</i> , 65 (12 μ m)	0	0

*Strain number.

†All attempts to take subcultures failed.

‡Salinity of culture medium increased to 16‰.

Heteramoeba clara

This brackish-water-living species inhabits supralittoral rock pools (DROOP, 1962). Like *Naegleria gruberi*, *Heteramoeba clara* is biphasic, existing as amoeba or flagellate. Either phase is capable of feeding and undergoing cell division indefinitely; change-over is under genetic control.

Isolation and purification. DROOP (1966a) obtained cultures of *Heteramoeba clara* from single washed cells with a high percentage of success. The amoebae were grown on *Brachiomonas submarina*, 44,* or in some instances on *Phaeodactylum*

Table 5-8

Heteramoeba clara. Doubling times during exponential population growth in second serial subculture obtained on the food organisms listed. Single algae and algae in pairs. Algal strain numbers refer to the Millport collection. In parentheses: standard error ($n = 4$) (After DROOP, 1966a; reproduced by permission of Allen and Unwin, Ltd.)

Food algae	Doubling time (hrs)
Single algae	
<i>Brachiomonas submarina</i> , 44*	10.07 (± 0.12)
<i>Tetraselmis carteriformis</i> , 10	27.0 (± 2.25)
<i>T. tetrathele</i> , 9	29.2 (± 4.0)
<i>Chlorella ellipsoidea</i> , 116	no growth
<i>Nannochloris oculata</i> , 66	extremely large
<i>Isochrysis galbana</i> , 58	no growth
<i>Monochrysis lutheri</i> , 60	no growth
Algae in combination	
<i>Monochrysis lutheri</i> and <i>Isochrysis galbana</i>	59.9 (± 1.97)
<i>M. lutheri</i> and <i>Chlorella ellipsoidea</i>	52.0 (± 4.8)
<i>I. galbana</i> and <i>C. ellipsoidea</i>	extremely large

*Strain number.

tricornutum, 14—until they had grazed all algae and were largely devoid of food vacuoles. Then, after being passed through 3 baths of sterile medium, they were placed singly in cultures of the food alga tested.

Sustenance. No culture medium is yet available that would sustain *Heteramoeba clara* in the absence of living food. Testing the ability of 30 strains of unicellular algae to support population growth of *H. clara*, DROOP (1966a) used a simple medium (Table 5-6). The algal strains tested and their ability to sustain population growth of *H. clara* from single-cell isolates are listed in Table 5-7. *H. clara* thrives on 15 out of 16 Volvocales, on 3 out of 4 Bacillariophyceae and on *Hemiselmis virescens* and *Porphyridium cruentum*, but on none of the Chlorococcales and Chrysophyceae offered. According to DROOP, the latter were unable to support population growth

*Strain number, see Table 5-7.

because they were: (i) too large, (ii) toxic (*Prymnesium parvum* and possibly *Cricosphaera elongata*), or (iii) not nutritious (possibly merely not digestible).

There was no clear indication whether nutritional deficiency was due to major or minor nutrients. Doubling times of *Heteramoeba clara* cultures obtained during exponential population growth are presented in Table 5-8. The sharp difference between algal strains that do and those that do not support growth suggested to DROOP (1966a) qualitative rather than quantitative differences, presumably chemical ones (see also PARSONS and co-authors, 1961).

Naegleria gruberi

Culture methods for the amoeba stage of the freshwater-living Sarcodina *Naegleria gruberi* have been developed by CHANG (1958). In view of the scarcity of pertinent information on marine forms, CHANG's methods deserve attention in the present context.

Isolation and purification. From freshly collected water samples, amoeba stages were isolated on Czapek agar containing penicillin (100 units) and streptomycin (200 $\mu\text{g ml}^{-1}$ medium). After several transfers on the same medium, coexistence with a Gram-negative bacillus became apparent. Omission of antibiotics resulted in a confluent mucoid growth due to bacterial swarming. Reliance on the bacterial associate for food was evidenced by confinement of *Naegleria gruberi* within the area of bacterial growth and by its feeding freely on the bacteria. The bacterium was identified as *Proteus mirabilis*. Transfers of pure mixed cultures on Czapek agar plates to slopes of the same medium always resulted in rapid death of the amoeba populations, while *P. mirabilis* continued to grow. The death of *N. gruberi* was due to accumulated acids in the mucoid growth at the bottom of the slopes. When the Czapek agar was replaced by buffered sucrose-nitrate agar, rich growth of *N. gruberi* was obtained in all slope subcultures.

Because of the relatively poor growth obtained with the method developed by SINGH (1946, 1950) on non-nutrient agar supplemented with living bacteria, the agar-block technique (cutting out a block of agar-plate culture and placing it face to face on a new plate to permit migration of the trophozoites away from the area of contact) has generally been employed for isolation of amoebae. With the rich growth attained with CHANG's (1958) method, the agar-block technique was unnecessary and isolation with or without the bacterial associate could be done by the 'giant colony technique' (OEHLER, 1916).

Sustenance. Pure mixed cultures of *Naegleria gruberi* have been maintained with living bacteria: *Escherichia coli*, *Aerobacter aerogenes* on buffered sucrose-tryptose agar, and with *Salmonella typhosa*, *S. paratyphi*, *S. schottmuelleri*, *S. enteritidis*, *S. cholerae-suis*, *S. typhimurium*, *S. meleagridis*, *S. pullorum* as well as *Shigella sonnei* and *S. dysenteriae* II on buffered sucrose-glucose-tryptose agar. Failures were encountered with *Bacillus subtilis*, *Pseudomonas pyocyanea*, and *Sarcina lutea*—attributable, with the two latter forms, to the toxic effect of their pigments. *N. gruberi* cannot grow in the absence of bacteria (rapid encystment and failure to excyst, unless edible bacteria are provided): incorporation of vitamins, amino acids and growth factors in the medium did not sustain the cultures. This result indicates complex nutritional requirements. Addition of edible bacteria killed by heating

(60° C for 6 mins) produced very poor growth. CHANG (1958) assumes that a thermo-labile growth-promoting factor present in the living bacteria is required.

(c) Foraminifera

With the exception of *Allogromia* sp.—which has been successfully cultivated in monoxenic bacterized culture (LEE and PIERCE, 1963)—foraminiferans have thus far, been cultured agnotobiotically. Techniques for crude, agnotobiotic cultures have been outlined by ARNOLD (1954a, b, 1966), GRELL (1957, 1958a, 1959), MYERS (1937), LEE and co-authors (1961a, b, 1963, 1970), FREUDENTHAL and co-authors (1963), RÖTTGER (1972a), and others.

Sea water and Erdschreiber are the most widely used culture media for agnotobiotic foraminiferan cultures. According to PROVASOLI and co-authors (1957), other media (e.g. ASP₇, D, DC) permitted survival but not reproduction; however, LEE and PIERCE (1963) reported that ASP₇ and modifications of that medium allowed good population growth of *Allogromia* sp.

A number of organisms have been used to feed foraminiferans: 'non-filamentous', unicellular algae (ARNOLD, 1954a, b); species of *Chlamydomonas*, *Platymonas*, *Amphidinium*, *Nitzschia*, *Navicula* (BRADSHAW, 1955); *Amphora purpusilla*, *Achnanthes brevipes*, *Cyclotella* sp., *Amphiprora paludosa*, *Dunaliella* spp., *Rhodomonas lens*, *Isochrysis galbana*, *Symbiodinium microadriaticum*, *Desmonales* sp., *Monochrysis lutheri*, *Peridinium* sp., *Prymnesium parvum* (LEE and co-authors, 1961a, b). *Elphidium crispum* feeds on *Phaeodactylum tricornerutum* (MURRAY, 1963). *Ammonia beccarii tepida* consumed washed *Dunaliella* sp. (BRADSHAW, 1961). Using tracer techniques, LEE and co-authors (1963) examined the nutritional values of 28 species of algae, 16 bacteria and 11 yeasts. Most of the foraminiferans studied thus far have complex nutritional requirements. These are better satisfied by a combination of food organisms than by a single food source (e.g. MULLER and LEE, 1969; LEE and co-authors, 1970).

A general account on cultivation methods for littoral foraminiferans has been presented by MYERS (1937). His methods have proved satisfactory for species of *Discorbis*, *Pyrgo*, *Triloculina*, *Bulimina*, *Patellina*, *Spirillina* and *Robulus*, and should be useful for related forms. MYERS obtained living foraminiferans by washing seaweed or eel grass between the hands. After allowing the foraminiferans a minute to settle, the water was decanted. Repeated washing by decantation frees the collection from most of the silt and debris. Crowding of newly collected material must be avoided. Not more than 5 cm³ of the washings containing foraminiferans were placed in a 10-cm round-bottomed finger bowl filled with sea water, or about 20 cm³ in a 25-cm crystallizing dish. At first, the culture water was changed twice a day; later, once a day. After about 2 weeks, many foraminiferans had crawled up the sides of the dishes and, if a suitable substrate of diatoms had developed, several species began to reproduce (see also LEE and co-authors, 1969). In order to establish single-species stock cultures, MYERS prepared dishes with a supply of food diatoms (e.g. pure cultures of species of *Nitzschia* or *Navicula*). After asexual reproduction, the young foraminiferans remained, for some time, in the vicinity of the parent test. Individuals of comparable age and size were cleaned (water stream)

and pipetted into new culture dishes. They were then washed with sterile media before inoculation into the final media.

In addition to the studies reviewed in the following pages, papers involving cultivation of foraminiferans have been published by MYERS (1935, 1943a, b), GRELL (1954a, b, c, 1956, 1957, 1958a, b, c, 1959, see also 1968), ARNOLD (1955), NYHOLM (1961), BRADSHAW (1957), LEE and co-authors (1959, 1962), PIERCE and co-authors (1961), HEDLEY and WAKEFIELD (1967), and LEE (1967, 1968).

Allogromia laticollaris, *Quinqueloculina lata*, *Rosalina leei* and *Spiroloculina hyalina*

These four members and related species of salt-marsh epiphytic communities have been cultivated by LEE and associates (e.g. LEE and co-authors, 1963, 1969; MULLER and LEE, 1969; LEE and co-authors, 1970; see also LEE and MULLER, 1975).

Isolation. Small pieces (0.2 g dry weight) of algae (e.g. species of *Zostera*, *Zanichellia*, *Ulva*, *Enteromorpha*, *Polysiphonia*, *Ceramium*) were gently removed by sterilized forceps and transferred to screw-cap test tubes (25 × 150 mm) containing 30 ml of sterile habitat sea water. The samples were placed in an insulated ice chest. Large numbers of foraminiferans were obtained by 'washing' bulk collections of algae, rubbing the algae against each other and thus freeing members of the epiphytic community from their substratum. After washing a dozen or so handfuls of algae, the contents of the wash water were allowed to settle for about 10 mins. The washing pail was decanted and the sediment poured through 4.76-mm, 1.0-mm and 500- μ m sieves. After a brief settling period, a 1.5-cm sediment layer was placed in 250-ml, wide-mouth, screw-capped plastic bottles. Finally, 200 ml of fresh sea water were added to each bottle and the bottles were then also placed in the ice chest.

After transporting the chilled samples to the laboratory, the tubes were agitated in a vortex mixer in order to separate the epiphytes from their substratum. Small aliquots were then inoculated into liquid differential media (Table 5-9), based on PROVASOLI and co-authors (1957), marine nutrient broth, Sabouraud's dextrose medium, or Erdschreiber, and streaked out on solidified agar plates of the same media. Usually, one culture tube (screw-capped borosilicate glass, 20 × 125 mm) contained 5 to 10 individuals.

Following aseptical washing through 18 transfers (9-hole spot plate in a microscope glove box), survivors were inoculated into Erdschreiber with various antibiotic mixtures (Table 5-10).

Sustenance. The newly isolated foraminiferans were incubated in an illuminated environmental chamber or a light bank at 25° C for 1 week (ca 60 to 500 ft. c.). Initial mortality rates were usually high. Only in about one of 25 bowls did the foraminiferans reproduce within the first few weeks. When the culture bowls reached densities of 500 or more adults, the foraminiferans were subcultured. LEE and co-authors (1970) recommend transfer of established cultures about once a month for higher yield. However, some species grow and reproduce over much longer periods without transfer. *Allogromia laticollaris*, for example, has been cultured continuously for over 1 year without medium change. In culture, the salinity

Table 5-9

Differential base S initial liquid media for isolation of salt-marsh epiphytic foraminiferans (After LEE and co-authors, 1970; reproduced by permission of Biologische Anstalt Helgoland)

	Component	Amount l ⁻¹	
	NaCl	25,000 mg	
	MgSO ₄ ·7H ₂ O	9000 mg	
	Tris	1000 mg	
	KCl	700 mg	
	Ca (as Cl ⁻)	300 mg	
	NH ₄ NO ₃	250 mg	
	Na glycerol. PO ₄	100 mg	
	B ₁₂	100 mg	
	NaH ₂ CO ₃	100 mg	
	NaSiO ₃ ·9H ₂ O	70 mg	
	NTA	70 mg	
	P II metals	30 ml	
	Additions (100 ml) ⁻¹ :		
1 Base alone		10 4 + 6 + 7	
2 B ₁₂	5·0 μgm%	11 Trypticase	5 mg%
Vitamins 8A*	1 ml 100 ⁻¹	Yeast extract	5 mg%
3 Soil extract	2 ml 100 ⁻¹	12 Yeast extract	5 mg%
4 NH ₄ NO ₃	10 mg%	13 AA mixture 18A†	
5 Alanine	50 mg%	14 AA mixture 18B†	
Glutamina acid	50 mg%	15 AA mixture 18(A + B)†	
Glycine	50 mg%	16 13 + 4 + 6	
6 Na glycerol. PO ₄	10 mg%	17 Acetone extract of lemon rind	0·1 ml%
NaH ₂ PO ₄	10 mg%	18 Acetone extract of <i>Enteromorpha intestinalis</i>	0·1 ml%
7 Na acetate	50 mg%	19 Acetone extract of <i>Zostera</i> sp.	0·1 ml%
Na lactate	50 mg%		
Glucose	100 mg%		
8 2 + 4			
9 2 + 3 + 4 + 5 + 6 + 7			
P II metals	3 ml 100 ⁻¹		
	*Vitamins 8A		
thiamine HCl	0·2 mg	biotin	0·5 μg
nicotinic acid	0·1 mg	choline H citrate	0·5 mg
putrescine 2 HCl	0·04 mg	inositol	1·0 mg
Ca pantothenate	0·1 mg	thymine	0·8 mg
riboflavin	5·0 μg	orotic acid	0·26 mg
pyridoxine 2 HCl	0·04 mg	B ₁₂	0·05 μg
pyridoxamine 2 HCl	0·02 mg	folinic acid	0·2 μg
p-aminobenzoic acid	0·01 mg	folic acid	2·5 μg
	†Amino acid mix 18		
Mixture A: alanine	1·0 mM	Mixture B: aspartate	1·0 mM
glycine	1·0 mM	leucine	1·0 mM
glutamate	1·0 mM	histidine	1·0 mM
lysine	1·0 mM	methionine	1·0 mM
arginine	1·0 mM		

range of *A. laticollaris* was 10 to 40‰; of *Rosalina leei*, 25 to 30‰; of *Spiroloculina hyalina*, 30 to 40‰.

Allogromia laticollaris, *Quinqueloculina lata*, *Rosalina leei* and *Spiroloculina hyalina* require bacteria for sustained reproduction in gnotobiotic culture (MULLER and LEE, 1969). None of the algae tested (*Amphora* spp., *Archais* sp., *Chlorococcum* sp., *Cylindrotheca closterium*, *Dunaliella parva*, *D. salina*, *Fragillaria* sp., *Isochrysis galbana*, *Monochrysis lutheri*, *Nannochloris* sp., *Navicula diversistriata*, *Nitzschia acicularis*, *N. brevirostris*, *N. spp.*, *Phaeodactylum tricornerutum*, *Prymnesium parvum*), singly or in combination, supported continuous reproduction of the 4 foraminiferans in bacteria-free culture. MULLER and LEE inferred that bacteria

Table 5-10

Antibiotic mixtures used for purification of Foraminifera cultures. All values are expressed as $\mu\text{g } 100 \text{ ml}^{-1}$ sea water. Mix 3 was used most often (After MULLER and LEE, 1969; reproduced by permission of Society of Protozoologists)

Components	Mix 1	Mix 2	Mix 3	Mix 4	Mix 5	Mix 6
Chloramphenicol	250	250	250		250	250
Novobiocin	200	200			400	
Coly-mycin		60			120	60
Dihydrostreptomycin SO ₄			2000			
Polymyxin B			60			
Erythromycin				50		
Fungizone				50		

(*Pseudomonas* sp., *Micrococcus* sp.) possess some nutritional factor required by the foraminiferans that is unavailable (in sufficient quantity) in a diet consisting exclusively of algae. It was possible to establish gnotobiotic clones of the 4 foraminiferans on bacteria and algae (usually 1 or 2 species). In balanced gnotobiotic cultures, neither light nor population density of foraminiferans was limiting. In older cultures, reduced pH values and metabolic waste products tended to depress rates of growth and reproduction.

Raising foraminiferans and their living food together has advantages and drawbacks (MULLER and LEE, 1969). It is simpler to transfer and maintain cultures containing both foraminiferans and food. However, foraminiferan productivity is higher if the algal foods are grown axenically, harvested by centrifugation, washed aseptically, and fed to the foraminiferans. Possibly, the algae produce inhibitory substances or compete for limiting substances with the foraminiferans.

MULLER and LEE (1969) draw attention to the need for providing appropriate light conditions. Excess illumination may lead to algal overgrowth or to changes in dominant food species, and sometimes to culture deterioration. ARNOLD (1954a, b) found light intensities from 5 to 20 ft. c. to be optimal for growth and stable flora-fauna relations.

Archaias angulatus

This foraminiferan was collected and isolated by LEE and ZUCKER (1969) with the aim of axenically isolating its symbiotic alga, and of elucidating the contribution made by the algal symbiont to the foraminiferan's nutrition. Collected from a bloom of *Archaias angulatus* in a shallow area of Biscayne Bay (Florida, USA), the foraminiferans were washed from *Thalassia testudinum* leaves into plastic buckets containing habitat sea water. After transportation to the laboratory, *A. angulatus* specimens were transferred to finger bowls and incubated under various light conditions.

Forty *Archaias angulatus* were washed in sterile sea water, cut and crushed, and their symbionts transferred to suitable media and axenized. Algae from crushed hosts were coccoid and highly vacuolated. The symbionts do not seem to be essential to the foraminiferan when other food is available. Apparently, as in corals, the symbiont enables *A. angulatus* to incorporate Ca more efficiently. Possibly, the symbiont enters the foraminiferan via food-uptake routes, but resists digestion.

Experiments on food selectivity and food uptake conducted by LEE and ZUCKER (1969) indicate a preference of *Archaias angulatus* for bacteria (isolated from a monoxenic culture of the symbiotic alga) and the 3 diatoms *Cylindrotheca closterium*, *Navicula diversistriata* and *Amphora* sp. The diatom *Nitzschia acicularis* was also readily eaten.

Heterostegina depressa

The large marine foraminiferan *Heterostegina depressa* has been cultivated non-axenically in partially synthetic filtered sea water of 35‰S (RÖTTGER, 1972a, 1974, and personal communication).

Isolation and sustenance. RÖTTGER obtained his material from Hawaiian waters where *Heterostegina depressa* occurs on coral surfaces. Non-purified cultures were established on glass plates (42 cm²) submerged in finger bowls of 10 cm diameter. Under a 300-lux photoperiod (14 hrs light) and at a temperature of 24° C, the unsterilized sea water was renewed every second or third day, and the foraminiferans cleaned by careful brushing (removal of ectoplasma cover with its epiphytic diatoms) every 10 to 14 days.

Heterostegina depressa contains unicellular algal symbionts and requires no additional food under the conditions described. Generation time varies from 3 to 8 months. Successful reproduction (multiple fission, each yielding between 10 and 600 daughter individuals) occurs predominantly in larger individuals. The number of daughter individuals produced increases with size (protoplasma volume) of the mother individual. Final size of offspring tends to decrease from generation to generation, and the F₃ generation no longer attains the minimum size required for reproduction. In no case was an F₅ generation obtained. This fact indicates that culture conditions are not yet entirely adequate (see also DIETZ-ELBRÄCHTER, 1971; LUTZE and co-authors, 1971; RÖTTGER, 1972b, c; RÖTTGER and BERGER, 1972; SPINDLER and RÖTTGER, 1973).

Culture experiments conducted under varying conditions of illumination (45, 300, 600, 2000 lux) indicate that optimum irradiances for the symbiotic algae are

near 300 lux (RÖTTGER, 1972b). In shallow coastal waters, *Heterostegina depressa* attains very high population densities, apparently due to successful symbiosis. The resulting prolific production of large tests may contribute substantially to calcareous sediment formation in the areas concerned.

During reproduction (multiple fission) of the megalospheric gamont of *Heterostegina depressa*, the protoplasm separates outside the parent test into the juveniles. All initial chambers receive some of the symbiotic algae from the parent protoplasm. The newly formed 2-chamber-stage receives a second set of symbiotic algae from the parent's residual protoplasm. Thereafter, calcification proceeds and the first ectoplasm sheath is formed (RÖTTGER, 1974).

Marginopora vertebralis

The foraminiferan *Marginopora vertebralis*, a large calcareous inhabitant of tropical reefs, has been cultivated by Ross (1972).

Isolation and sustenance. Collected near the Great Barrier Reef (Australia), *Marginopora vertebralis* were transferred to 3 types of culture enclosures: fibre-glass window-screen baskets with calcareous debris substrates, similar baskets without the calcareous substrate, and glass bottles of 55 ml or 190 ml capacity. All samples were spread in a 1- to 2-cm layer on the bottom of the screen baskets, and the baskets suspended about 5 cm below styrofoam floats in tanks receiving recirculating sea water. After 1 day, most of the living foraminiferans had worked their way to the top of the substrate; they were transferred to bottles filled with sea water and submerged except for their openings. The water in the bottles was changed twice daily. After the second week, the bottle mouths were covered with window screen to keep larger predators out, and placed on the bottom of the sea-water tanks. The tanks (3 m in diameter and 0.7 m deep) are part of the sea-water system of the Research Station at Mourilyan Harbour. The temperature of the tank water remained between 26° and 29° C, the salinity between 34.5 and 25.0‰, the pH between 8.0 and 8.2. Sufficient food (diatoms, small unicellular algae and occasionally parts of small invertebrates) was provided by the flora and fauna of the aquarium system. Bacterial food seems to be essential. The role of symbionts requires further investigation.

(d) Ciliata

Ciliate cultures are used for a large variety of biological and biochemical studies. Limnic representatives such as members of the genera *Tetrahymena* and *Paramecium* have provided 'laboratory animals' par excellence. Much of our present knowledge on reproduction, physiology, genetics, immunology and parasitology of unicells has been derived from experiments with these forms. Consideration of the numerous papers devoted to the cultivation of freshwater-living ciliates is beyond the scope of this chapter. In regard to *Tetrahymena pyriformis*—first cultivated axenically by LWOFF (1923)—important information has been provided, for example, by HOLZ and co-authors (1962), LEICK and PLESNER (1968) and RASMUSSEN and KLUDT (1970); see also Chapter 5.11 (p. 1310). For a guide to the literature on *Tetrahymena* see CORLISS (1973a). Cultivation of *Paramecium aurelia* and *P. caudatum*

has received attention, for example, from VAN WAGTENDONK and HACKETT (1949), VAN WAGTENDONK and co-authors (1953), VAN WAGTENDONK (1955, 1974), MILLER and VAN WAGTENDONK (1956), STERBENZ (1956a, b), TARANTOLA and VAN WAGTENDONK (1959), CORLISS (1961), LILLY and KLOSEK (1961), REILLY and co-authors (1961), SOLDI (1963, 1967), REILLY (1964), SOLDI and VAN WAGTENDONK (1967, 1969) and VAN WAGTENDONK and SOLDI (1970).

Tetrahymena pyriformis can be cultured without difficulty in media containing proteose peptone; vitamin (e.g. yeast extract; KIDDER and DEWEY, 1951) and/or lipid addition (e.g. fatty acids, phospholipids, sterols; HOLZ, 1964) facilitates luxurious growth and reproduction. Representatives of the genus *Paramecium* exhibit additional requirements for maximum growth and reproduction, e.g. nucleic acids (VAN WAGTENDONK and SOLDI, 1970). Marine ciliates appear to have requirements similar to those of the more fastidious limnic *Tetrahymena* and *Paramecium* species (SOLDI and MERLIN, 1971, 1972). Axenic cultivation of marine ciliates, their collection and purification, as well as the media used, are treated in detail in Chapter 5.11 (pp. 1307 to 1312).

Condylostoma sp.

Collected from brine pools in Israel, the euryhaline *Condylostoma* sp. were cultivated axenically by KAHAN and co-authors (in press) in 'Walne medium'* (continuous fluorescent light; 18° to 29° C; mostly 36‰S). Maximum growth and shortest generation times (0.7 to 1.3 days) were obtained on a mixture of *Dunaliella salina*, *D. tertiolecta* and *D. primolecta*. If offered uni-algal suspensions, *Condylostoma* sp. grew best on *D. salina* (generation time ca 5 days). Bacteria (*Aerobacter aerogenes*), grown in 0.15% lettuce broth or on brain-heart agar (Difco) slants and dispersed in 10 ml distilled water, proved to be a less satisfactory diet than the algae mentioned. Sometimes, giant cells with several oral grooves developed in the cultures, indicating non-optimum conditions.

Diafolliculina rotunda, *Eufolliculina* sp. and *Metafolliculina andrewsi*

These sessile, loricated, littoral, heterotrich ciliates have been cultivated by UHLIG (1965) under non-sterile conditions, and with the harpacticoid *Tisbe holothuriae* (p. 765) as culture partner. UHLIG used stagnant Seitz-filtered sea water that had been exposed to 90° C for 1 hr; and glass dishes (10 cm diameter, 5 cm high) covered with a glass lid. *Dunaliella* sp. and *Cryptomonas* sp. served as food sources. In the absence of *T. holothuriae*, all cultures developed within a few days a rapidly increasing detritus-bacteria-fungi layer which soon overgrew the folliculinids causing degeneration and, finally, death. *T. holothuriae* consumes the detritus-bacteria-fungi layer as it develops. A balance between layer growth and harpacticoid population density is quickly attained and is quite stable.† If too numerous, the

* Walne medium: Add 1 ml of stock solution to 1 l of artificial sea water (Instant Ocean, 36‰S). Stock solution composition 1 l⁻¹ of distilled water: NaNO₃, 300 g; NaH₂PO₄·2H₂O, 30.0 g; MnCl₂·4H₂O, 4.7 g; EDTA, sodium salt, 3.36 g; FeSO₄·7H₂O, 2.78 g.

† A comparable balance has been reported to facilitate cultivation in some sessile cnidarians (p. 645).

harpacticoids may damage the loricae. While no exact values are presented, 20 to 30 harpacticoids per culture dish seem adequate.

UHLIG (1965) recommends separating freshly collected folliculinids from their loricae: the foot organelle is disengaged from the lorica (steel needle), the ciliate sucked into a fine pipette and then transferred to a culture dish. After 2 to 4 days, these 'naked' individuals transform into swarm spores (UHLIG, 1972a). As in other protozoans and invertebrates, free-living stages (in the present case, the swarm spores) attach themselves more readily to substrates with a thin bacterial film than to 'clean' surfaces. Serial transfer of recently settled individuals yields pure cultures. Details on the life cycle of *Metafolliculina andrewsi* have been presented by UHLIG (1963, 1972a).

Euplotes Species

LEE and FENCHEL (1972) established *Euplotes antarcticus* in culture and compared its rates of survival and growth with those observed in cultured temperate *E. vannus* and tropical *E. balteatus*. Upon slow re-acclimation, the thermal ranges of the 3 species could be extended significantly. The total range of 'infinite survival' was from -2° to 10° C for *E. antarcticus*, from -2° to about 30° C for *E. vannus*, and from 5° to about 40° C for *E. balteatus*. A comparison of the rates of population growth revealed no temperature compensation: the Antarctic ciliates exhibit growth rates that would be expected from extrapolating the temperature-growth-rate curves of ciliates from warm habitats to low temperatures.

Collected from slush-ice samples near Filchner Ice Shelf, *Euplotes antarcticus* were isolated, after a year's storage, from water samples collected at the ice-water interface below the hard ice layer. During storage, the samples were held in Nalgene plastic bottles at -1.8° C under a fluorescent light source (80 to 100 ft. c.). Mixed cultures were sustained on E₂ medium (GOLD, 1964) at -2.0° C. *E. antarcticus* immediately undergoes cytolysis when exposed to temperatures above 5° C. Hence, all cultures were kept at -1.8° C, using a precooled microscope and precooled slides and cover slips for microscopic observations. The food consisted of bacteria (no details given) grown for 24 hrs at room temperature on 0.05 g peptone in 100 ml of Millipore filtered sea water. Single individuals were placed in about 1 cm³ of medium contained in a small, covered glass dish and incubated at pre-determined temperatures. Generation times of the three ciliate species from Antarctic, temperate and tropical habitats, cultured under identical conditions, are compared in Fig. 5-1.

WICHTERMAN (1967) studied mating types, breeding, conjugation and nuclear phenomena in cultured populations of the marine *Euplotes cristatus*, and PAVLOVSKAYA (1969) examined the algal nutrition of some related Black Sea ciliates. The marine benthic *Euplotes* sp. has been sustained in culture at 22° to 24° C in 33‰ S by LUEKEN (1973). It consumed bacteria which lived on small pieces of beef placed in the culture enclosures (Petri dishes or depression slides for clones; glass vessels with 300 ml of water for stocks). Conjugation occurs promptly if clones of opposite mating types are mixed after slight starvation. *E.* sp. cultures were maintained by KAHAN and co-authors (in press) in small test tubes at 26° C in 36‰ S and received as food *Aerobacter aerogenes* plus 0.3% lettuce broth. At population

densities of up to 4000 cells ml⁻¹, the generation time was 10 to 11 hrs. The cultures survived in salinities ranging from 20 to 50‰S.

The microphagous *Euplotes vannus* was cultivated in 5-cm Petri dishes by PERSOONE and DEPLAECIE (1972). Culture experiments were always started with exconjugants. Ten thousand to 20,000 cells of homogenized baker's yeast were offered in 5 ml of medium. In good cultures, the stationary population phase was attained in 7 days; this implicates a mean cell-division rate of 12 hrs (20° to 25° C). Salinities of 20‰, 25‰, 30‰ and 35‰ yielded similar results confirming a high degree of euryhalinity for *E. vannus*.

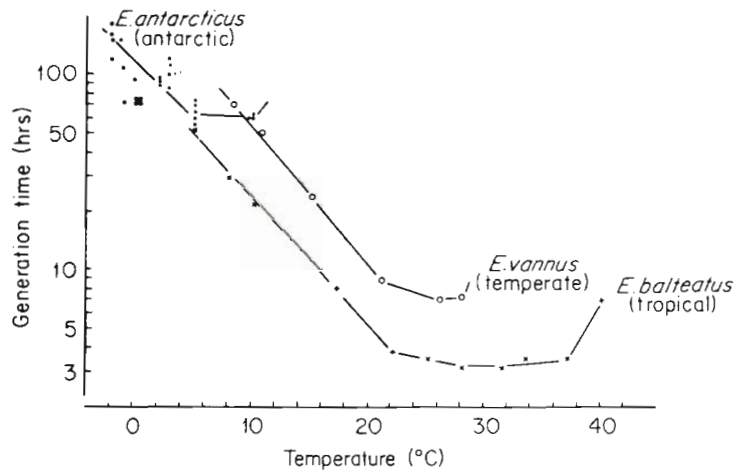

Fig. 5-1: *Euplotes* species from Antarctic, temperate and tropical habitats, cultured under identical conditions. The generation times of the 3 ciliates differ significantly. (After LEE and FENCHEL, 1972; modified; reproduced by permission of VEB Gustav Fischer, Jena.)

Fabrea salina

The pelagic *Fabrea salina* grows and reproduces over a wide range of temperatures (5° to 40° C) and salinities (up to 100‰S); it varies in cell size from 60 to 400 μm. *F. salina* was grown on *Dunaliella salina* to densities of up to 1200 individuals ml⁻¹ (KAHAN and co-authors, in press). At 37° C and 40° C and in 36‰S, shorter generation times (ca. 6 hrs) were obtained with *D. parva*, *D. primolecta*, *D. salina*, *D. suecica* and *D. tertiolecta* than with *Phaeodactylum tricornutum* and *Tetraselmis chuii* (8 to 9 hrs). In 'Walne medium' (see footnote on p. 602), maximum growth was obtained under continuous illumination, at 37° C and 40° C, in sea water of 36‰S. In aged cultures, cysts were formed.

Fabrea salina grows well also on dry foods such as yeast (DE WINTER and PERSOONE, in press). With *Dunaliella viridis* as sole food source, population densities of up to several hundred individuals ml⁻¹ can be maintained. In 30-l, aerated

polyethylene bags (15 cm diameter, 200 cm height) 200 individuals ml⁻¹ were obtained with a generation time of 12 hrs. For mass cultures, continuously aerated raceways proved promising. *F. salina* holds considerable promise as a food organism (p. 621).

Favella campanula

The nutritional requirements of *Favella campanula* have been explored by GOLD (1969b).

Isolation and purification. Collected with a plankton net (64 μ m), the tintinnids were micropipetted, within a few hours of collection, into 10 ml sterile medium contained in 125- \times 20-mm screw-cap test tubes. Because some of the 'contaminants' appeared to inhibit growth of *Favella campanula*, at first, frequent transfers were made. Eventually, a non-inhibitory flora remained.

Sustenance. Principal foods added to the agnotobiotic cultures were: non-toxic phytoflagellates and the dinoflagellates *Glenodinium foliaceum* and *Peridinium trochoideum*. The latter were grown in medium E₂ (GOLD, 1964) or in E₂y (E₂ supplemented with 0.5 mg ml⁻¹ yeast extract) and fed to *Favella campanula* 3 to 4 times a week as required. The dinoflagellates—generally harvested in log-growth phase—were centrifuged and washed 4 to 6 times in 10-ml portions of E₂. After the final wash, *G. foliaceum* were resuspended in E₂, allowed to stand overnight while the cells regained motility, and then used for feeding. Subcultures of *F. campanula* were made every 7 to 10 days when they had reached maximum yield (cells aggregated at the surface or at the bottom of the test tubes.) A large inoculum was assured by drawing off medium for transfer with a 2-ml rubber bulb attached to a Pasteur pipette. Alternatively, 2 other methods were used: (i) addition of 1 ml of culture to 10 ml of fresh medium D; (ii) large numbers of *F. campanula* were transferred by micropipette to 10 ml of fresh medium. The cultures were kept in light-dark cycles of varying lengths (up to 300 ft. c.). In short-term feeding experiments (up to 72 hrs), cultures were kept in darkness to reduce the effects of algal growth. Cultivation temperature was 20° C.

For *Favella campanula*—as well as for *Tintinnopsis tubulosa* (GOLD, 1968, 1969b) and *T. lohmani* (GOLD, 1969a)—there appeared to be two curves of population growth superimposed on each other, and detectable only after extended periods of cultivation (GOLD, 1970): (i) a normal growth curve, often erratic, which typically included a lag phase, logarithmic growth, stationary and death phases; (ii) a longer oscillation period during which the strain lost its viability and eventually could not be revived—characteristic of population ageing. Similar fluctuations have been reported from Foraminifera cultures (LEE and co-authors, 1966). The reason for the decline in viability of GOLD's tintinnid cultures is unknown. GOLD (1969b) suggests failure to conjugate as a possible explanation; he also suspects that a change in culture conditions may be required at some stage of the life cycle (GOLD, 1970). In *F. campanula*, cultivation was accompanied by progressive decrease in cell size. This may have been due to cell-division rates faster than those experienced under field conditions. Cultivation also caused a diminution in average lorica length of *F. campanula* and, apparently, a tendency toward reduction of the posterior horn (GOLD, 1969b).

Keronopsis rubra

The benthic hypotrichous ciliate *Keronopsis rubra* has been cultivated by WALKER (1975) and KAHAN and co-authors (in press).

WALKER (1975) obtained *Keronopsis rubra* from an aquarium containing material from a coral reef. Ciliate stocks were maintained in natural daylight at 23° C in 34‰ S. As food, they received a strain of bacteria, derived from lettuce decomposing in local sea water and subsequently cultivated in a sterile sea-water/lettuce infusion. Crystallizing dishes with 50 ml sterile sea water and 1 ml bacteria suspension were stocked with 20 to 100 *K. rubra* and the cultures fed twice a week. Subcultures were set up when the population density reached 200 cells ml⁻¹. Subnormal sal-

Table 5-11

C medium for cultivation of marine ciliates. Final pH: 7.2 (After SOLDO and MERLIN, 1972; reproduced by permission of Society of Protozoologists)

Component	Concentration
	mg ml ⁻¹
Proteose peptone	10.0
Trypticase	10.0
Yeast nucleic acid	1.0
Cerophyl extract	5.0
	µg ml ⁻¹
Biotin	0.0001
Calcium pantothenate	1.0
Folic acid	0.5
Nicotinamide	0.5
Pyridoxal.HCl	0.5
Riboflavin	0.5
Thiamine.HCl	1.5
DL-Thioctic acid	0.01

inities retard fission and lead to increased mortality; supranormal salinities improve fission rates and long-term viability.

KAHAN and co-authors (in press) collected *Keronopsis rubra* from the Mediterranean coast near Tel Aviv (Israel) and sustained this ciliate at 18° to 27° C in culture enclosures containing 30 ml of sea water, to which 3 grains of wheat, rice or rice crispies had been added (KAHAN and co-authors, in press). *K. rubra* thrived on the developing bacteria as well as on unicellular algae such as *Dunaliella tertiolecta* and *Phaeodactylum tricornutum*. Generation time varied from 1 to 2 days. Bleaching of cultured *K. rubra* could be reversed after adding a mixture of unicellular algae. In the presence of synthetic fibres (increase in surface area), growth rates improved. Maximum growth was obtained after dispersing 0.6 g of dried bread in the culture water.

Miamiensis avidus, *M. sp.*, *Parauronema virginianum* and *Uronema nigricans*

KANESHIRO and co-authors (1969a, b) have cultured *Miamiensis avidus*, a facultative parasite of sea horses, in a medium of the following composition: lactalbumin hydrolysate solution (10%, w/v), 10 ml; calf serum, 5 ml; filtered sea water, 85 ml. All components were sterilized separately and combined aseptically.

Table 5-12

S medium for cultivation of marine ciliates. Final pH: 7.2 (After SOLDI and MERLIN, 1972; reproduced by permission of the Society of Protozoologists)

Component	$\mu\text{g ml}^{-1}$	Component	$\mu\text{g ml}^{-1}$
L-Alanine	900	Calcium pantothenate	5.0
L-Arginine	900	Folic acid	2.5
L-Asparagine	270	Nicotinamide	2.5
L-Aspartic acid	300	Pyridoxal HCl	2.5
L-Glutamic acid	1200	Riboflavin	2.5
Glycine	225	Thiamine HCl	7.5
L-Histidine	300	DL-6-Thioctic acid	0.05
L-Isoleucine	375	Asolectin	200
L-Leucine	375	Cephalin	200
L-Lysine HCl	750	Tween 80	200
L-Methionine	450	NaCl	16400
L-Phenylalanine	375	MgSO ₄	1980
L-Proline	225	MgCl ₂	1390
DL-Serine	900	CaCl ₂	710
DL-Threonine	1050	KCl	430
L-Tryptophan	225	HCO ₃	73
L-Tyrosine	225	Br	36
DL-Valine	600	B	5
Adenosine	90	PO ₄ ⁼	2.7
Guanosine, 2,3 Phosphate	150	NO ₃ ⁻	1.8
Cytidine	90	Si	1.4
Uridine	90	NH ⁺	1.0
Thymidine	80	Al	0.8
Biotin	0.0005	Li	0.2

The complete medium was adjusted to pH 7.5 with sterile 4.2% NaHCO₃ (see also MOEWUS, 1963).

For symbiote-free strains of the marine ciliates *Miamiensis avidus*, *M. sp.*, *Parauronema virginianum*, *Uronema nigricans* and 3 unidentified species, SOLDI and MERLIN (1971, 1972) developed three axenic media: Cerophyl medium (C), maintenance medium (M), and synthetic medium (S). For details on axenic cultivation of these ciliates consult Chapter 5.11 (p. 1307).

C-medium components are listed in Table 5-11. To 100 ml of sea water ($d = 1.015$), 0.5 g of powdered Cerophyl must be added and an extract prepared by bringing the mixture to a boil. After filtration 3 times through glass wool while hot to remove

undissolved materials, each of the following components are dissolved in the extract: proteose peptone, 1 g; trypticase, 1 g; yeast nucleic acid, 0.1 g; vitamin mixture, 0.1 ml. The medium is adjusted to pH 7.2 with 1N NaOH and sterilized by autoclaving at 121° C for 15 mins. The vitamin mixture is prepared in 100 ml of distilled water by mixing together under constant stirring (all quantities in mg): biotin, 0.01; calcium pantothenate, 100; folic acid, 50; nicotinamide, 50; pyridoxal. HCl, 50; riboflavin, 50; thiamine. HCl, 150; DL-thioctic acid, 1.0. The mixture is flushed with nitrogen and stored at -20° C in small portions. The portions are thawed as needed and used only once. Not all components of the vitamin mixture are soluble in distilled water at the concentrations used. To ensure uniform distribution of the insoluble vitamins, aliquots are removed from thawed mixtures only while under constant stirring.

Table 5-13

Population growth (percent maximum growth) of 3 marine ciliates in M medium with individual components deleted (After SOLDO and MERLIN, 1972; reproduced by permission of Society of Protozoologists)

Component deleted	<i>Miamiensis</i> sp.	<i>Parauronema virginianum</i>	<i>Uronema nigricans</i>
None	100	100	100
Proteose peptone	6	6	12
Trypticase	0	27	11
Proteose peptone and trypticase	0	2	0
Yeast nucleic acid	120	97	0
Vitamins	50	0	0
Lipids	5	0	5

M medium is similar in composition to C medium, except that the Cerophyl extract is replaced with a lipid mixture. Twenty mg each of asolectin, cephalin and Tween 80, dispersed in 25 ml of distilled water by constant stirring for 1 hr at 80° C are added to 75 ml of sea water ($d = 1.020$) with proteose peptone, 1 g; trypticase, 1 g; yeast nucleic acid, 0.1 g; vitamin mixture, 0.1 ml. The medium is adjusted to pH 7.2 with 1 N NaOH and sterilized by autoclaving at 121° C for 15 mins.

S medium (Table 5-12) is prepared as follows: Twenty mg of each, asolectin, cephalin and Tween 80 are dispersed in 25 ml of distilled water by stirring for 1 hr at 80° C and added to 75 ml artificial sea water ($d = 1.020$) in which 1.0 g of an amino-acid mixture and 0.05 g of a purine and pyrimidine mixture, prepared as described by SOLDO and VAN WAGTENDONK (1969), are dissolved; 0.5 ml of the vitamin mixture is then added. The medium is adjusted to pH 7.2 with 1 N NaOH and sterilized at 121° C for 15 mins (see also p. 1308).

Three types of sea water were used: source sea water (habitat sea water passed through Millipore filter of 0.45- μ m pore size; instant sea water (0.454 kg of Aquamarine salts, dissolved in 12 l of distilled water and filtered through glass wool);

artificial sea water. The desired final density of the sea-water medium was adjusted with distilled water.

Experiments conducted at 5 different temperature levels revealed maximum population development at 22° and 27° C. The density of the sea water in which the culture medium was prepared also markedly affected the growth in all 3 species tested: *Miamiensis* sp., *Parauronema virginiatum* and *Uronema nigricans* (Fig. 5-2). For *U. nigricans* and *P. virginiatum* a density of 1.010 yields maximum growth; for *Miamiensis* sp. 1.020. While *U. nigricans* grows well also in a medium prepared in fresh water, *M. sp.* and *P. virginiatum* grow very poorly under such conditions.

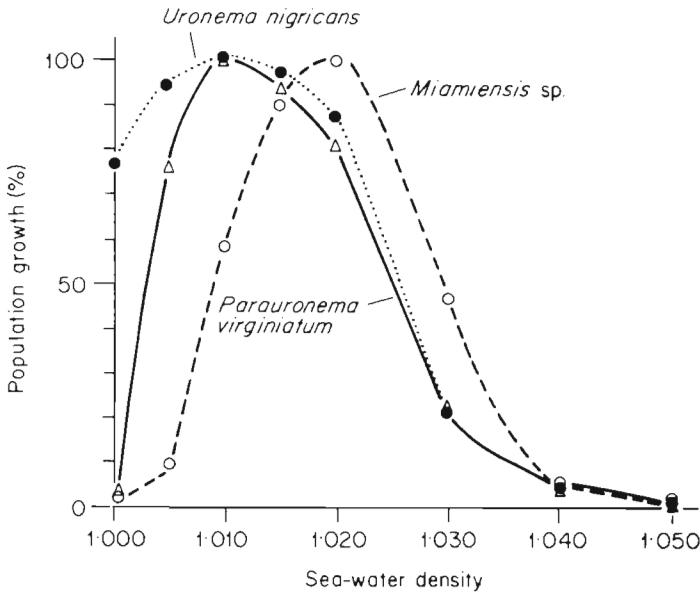

Fig. 5-2: Culture strains of 3 marine ciliates: population growth in M medium as a function of artificial sea-water density. Darkness; 27° C. (After SOLDO and MERLIN, 1972; modified; reproduced by permission of Society of Protozoologists.)

Surface to volume ratios of the medium significantly affect the carrying capacity of the culture system. A surface: volume ratio of 5.0 cm²: 1 ml of M medium supports 3 to 4 times more individuals (*Uronema nigricans* with 3.2 average fissions day⁻¹ during logarithmic growth; *Miamiensis* sp., 2.3; *Parauronema virginiatum*, 2.6) than at 0.4 cm²: 1 ml. Population growth of *Miamiensis* sp., *Parauronema virginiatum* and *Uronema nigricans* in the absence of individual M-medium components shows that proteose peptone and trypticase are essential for maximum growth of all three (Table 5-13). Yeast nucleic acid is essential for *U. nigricans*, but not for *M. sp.* and *P. virginiatum*. In the absence of added vitamins, growth of *U. nigricans* and *P. virginiatum* is reduced to zero, that of *M. sp.* to 50% of the maximum measured. For maximum population growth, also lipids are essential. None of the single lipids tested was as effective in supporting growth as a combination of asolectin, cephalin and Tween 80 (Table 5-14).

Paramecium Species

Until recently, axenic cultivation of *Paramecium* species was restricted to fresh-water forms. DICKERSON and co-authors (1963) and NAPOLITANO and LILLY (1972) succeeded in maintaining the brackish-water *Paramecium calkinsi* axenically (Chapter 5.11). Although limited growth was obtained in a defined medium developed for *P. trichium*, a satisfactory chemically defined medium has not yet been perfected for *P. calkinsi*. The stock medium employed by DICKERSON and co-authors contained an infusion prepared by boiling 10 g of split dried green peas

Table 5-14

Culture strains of 3 marine ciliates. Population growth (percent maximum growth) as a function of lipid addition to M medium. 27° C, darkness (After SOLDO and MERLIN, 1972; reproduced by permission of Society of Protozoologists)

Lipid	<i>Miamiensis</i> sp.	<i>Parauronema</i> <i>virginianum</i>	<i>Uronema</i> <i>nigricans</i>
Asolectin + Cephalin			
+ Tween 80	100	100	100
Asolectin	42	50	67
Aztec 4135	0	0	0
Cephalin	70	26	30
Lecithin	42	7	47
Phosphatidyl ethanolamine	42	11	18
Phosphatidyl inositol	19	—	5
Phosphatidyl serine	29	14	26
Tween 20	11	16	0
Tween 40	48	14	24
Tween 60	49	10	17
Tween 80	56	21	32
None	1	2	1

for 20 mins in 100 ml of water. To this were added: dextrose, 2.5 g; proteose peptone (Difco), 2.5 g; and brewer's yeast powder, 10 g; water was then added to bring the mixture to 1 l, and the pH was adjusted to 7.0. The stock medium was autoclaved at 120° C for 20 mins. For optimum growth, the suspended particles were not removed.

NAPOLITANO and LILLY (1972) used a yeast autolysate-sea-water medium. The autolysate was prepared by mixing 25 g of Fleischmann's Active Dry Yeast in 100 ml of artificial sea water (Aqua Marine; density 1.015) with constant stirring for 3 hrs at 60° C. Coarse yeast particles were removed by centrifugation. The complete medium was prepared by combining proteose peptone (Difco), 5 g; dextrose, 5 g; artificial sea water, 950 ml with the yeast supernatant, 50 ml. The medium was adjusted to pH 7.3 with 1 N NaOH, autoclaved at 120° C for 15 mins. Cultures

incubated in this medium have routinely attained population densities of 3500 individuals ml⁻¹.

Tintinnopsis Species

In *Tintinnopsis beroidea*, a marked change in culture conditions was necessary when microconjugant formation was at its peak. While rather indifferent to the environment in culture flasks during fission, *T. beroidea* became critically sensitive during periods of anisogamous conjugation. The normal test tubes had to be replaced by large vessels containing 3 to 4 l of medium (GOLD, 1971a). A vigorous strain of *T. beroidea* was obtained by mixing several isolates (GOLD, 1971b). The initial amount of food had a noticeable effect on population growth. Excessive amounts of food were somewhat inhibitory, while insufficient food resulted rapidly in starvation. At 12.5° C and an optimum food ration, doubling times of newly isolated tintinnids were 0.8 day for one strain, and 1.1 day for the other (GOLD, 1971c). These doubling times are probably representative of the growth potential in the sea, whereas the longer doubling times previously obtained in cultures (e.g. 2.5 to 6 days: GOLD, 1971b) may reflect aging of cells cultivated for extended periods and/or inadequate culture conditions. Methods for continuous culture of *T. beroidea* have been described by GOLD (1973; see Chapter 2, p. 215).

Culture methods for *Tintinnopsis tubulosa* have been developed by GOLD (1968, 1969b).

Isolation and purification. From freshly collected water samples, individuals were micropipetted into 10-ml portions of cold, sterile sea water in 125 × 20-mm screw-cap test tubes. An antibiotic mixture of penicillin and streptomycin was added to control bacterial populations (final concentration of each: 50 µg ml⁻¹). This concentration proved to be non-toxic to the tintinnids and to markedly reduce the number of bacteria in the culture.

Sustenance. The cultures were kept in the dark at 10° to 12° C. After a few days, the cells began multiplying. Once it became possible to subculture the original isolates, cultures were kept in the light and in the dark. *Tintinnopsis tubulosa* was fed small quantities of yeast and flagellates. Initially, food was offered at 2- to 3-day intervals. However, cultures kept later in the light required less frequent feeding or none at all, depending upon the rates of grazing and flagellate multiplication.

In an effort to standardize cultivation methods for marine Tintinnida, *Tintinnopsis tubulosa* were kept at 10° C with 12-hr alternating light and dark periods. The low temperature appears to be essential for certain strains. *T. tubulosa* cannot tolerate temperatures much higher than 10° C. Low temperatures also prevent algal overgrowth which is usually inhibitory to these ciliates.

Standardized medium. Local sea water proved to be unsatisfactory because of its variable quality. Therefore, a modification of the DC medium of PROVASOLI and co-authors (1957) was used (Table 5-15). The mixture of antibiotics is added to the medium aseptically prior to inoculation (final concentrations of penicillin and streptomycin remain 50 µg l⁻¹ each).

Standardized nutrition. *Tintinnopsis tubulosa* was fed twice a week from bacteria-free algal cultures. The food mixture consisted of *Rhodomonas lens*,

Isochrysis galbana, *Platymonas tetrathele* and *Saccharomyces cerevisiae*. Although no attempt was made to standardize the number of cells added at each feeding, cell counts were made on one occasion to establish a guide to the amounts of food organisms added. The numbers of cells mm^{-3} in the food mixture were: *R. lens*, 1320; *I. galbana*, 440; *P. tetrathele*, 520; *S. cerevisiae*, 1980. Portions of 0.1 ml were added to tubes which contained 10 ml of medium. In addition, the choanoflagellate *Diaphanoeca grandis* and an extremely small bacteria population were present (carried over from the original isolation). While GOLD (1968) assumes *D. grandis* to contribute material for the formation of the tintinnid lorica, the bacteria are believed to be nutritionally insignificant.

Table 5-15

Standard medium for cultivating marine Tintinnida.
pH 7.5 to 7.8 (Based on PROVASOLI and co-authors,
1957; after GOLD, 1968; reproduced by permission of
Society of Protozoologists)

Component	Amount	Component	Amount
NaCl	18 g	$\text{Na}_2\text{SiO}_3 \cdot 9\text{H}_2\text{O}$	200 mg
$\text{MgSO}_4 \cdot 7\text{H}_2\text{O}$	5 g	K_2HPO_4	30 mg
KCl	0.6 g	Metals mix*	1 ml
NaNO_3	0.5 g	Tris	0.5 g
Ca (as chloride)	0.1 g	Distilled water	1 l

*1 ml Metals mix contains Na_2EDTA , 10 mg; H_3BO_3 , 10 mg; $\text{MnCl}_2 \cdot 4\text{H}_2\text{O}$, 1.5 mg; $\text{FeCl}_3 \cdot 6\text{H}_2\text{O}$, 0.5 mg; ZnCl_2 , 0.1 mg; $\text{CoCl}_2 \cdot 6\text{H}_2\text{O}$, 0.05 mg.

Uronema Species

The pelagic marine ciliate *Uronema* sp. has been cultivated by HAMILTON and PRESLAN (1969).

Isolation and purification. Collected from an open-ocean water sample taken aseptically at a depth of 385 m, the ciliates were transferred into a sterile screw-capped bottle, diluted with an equal volume of sterile, double-strength algal medium (after GUILLARD and RYTHER, 1962) and incubated at 20° C in subdued light for about a month. At this time, a sample revealed a bacterial bloom and small numbers of *Uronema* sp. Incubation was continued until the numbers of *Uronema* sp. increased. From this enrichment, bacterial isolations were made using modified medium 2216E (CARLUCCI and PRAMER, 1957). Ten dominant-strains of bacteria were isolated, purified and re-introduced into aseptically sampled aliquots of the original enrichment. However, only two of the isolates produced large *Uronema* sp. populations.

Sustenance. One of the two bacterial isolates was selected as food source. It was grown in shaken flasks of 2216E broth. When the bacterial culture was in exponential growth phase (24 hrs), the cells were harvested by centrifugation (12,000 rpm at 5° C), aseptically resuspended, and recentrifuged. The resulting pellet was then

suspended in sterile sea water. Both the bacterium and *Uronema* sp. grew well in artificial sea water. From single cell isolations, two ciliate clones were started and transferred weekly by adding 0.1 ml (about 10^4 cells) of the previous week's culture to 10 to 20 ml of fresh bacterial suspension (about 10^9 bacteria). These stock cultures were incubated at 20° C in the dark. At a low level, a bacterial contaminant persisted in the cultures.

Since the original bacterial isolate ceased to grow on the media provided, and the second isolate, which produced good growth of *Uronema* sp., formed clumps of cells, *Serratia marino rubra* (strain SIO) was used; it produced the same doubling times and yield of *U.* sp. as previously observed. Although static cultures resulted in more reproducible results, generation time appeared to be the same for static and shaken cultures. Optimum temperature for population growth and yield (number of *U.* sp. individuals per number of bacteria added) was about 25° C; optimum salinity was between 17‰ and 43‰. While temperature and pH optima were consistent with those observed for isolates of other marine ciliates (FENCHEL, 1968), the *Uronema* strain tested was exceptionally euryhaline. The rate of formation of food vacuoles and the rate of lysis of their contents was much faster than observed in other ciliates. The cell volume changed significantly during flask culture.

A strain of the euryhaline *Uronema marinum* from a coastal habitat was cultivated by LEE and co-authors (1971; see also p. 607 and p. 615).

Isolation and purification. Freshly collected *Uronema marinum* were isolated in axenic culture (Chapter 5.11, p. 1308). The initial isolation medium was marine nutrient broth supplemented with liver extract and autoclaved *Pseudomonas* sp. Prior to this study, *U. marinum* had been cultivated monoxenically on *P.* sp. for several years.

Sustenance. The synthetic nutrient medium for the *Uronema marinum* strain in question consisted of: NaCl, 2.6%; MgSO₄, 0.5%; KCl, 0.075%; NH₄NO₃, 0.01%; Na glycerol phosphate, 0.002%; Tris, 0.1%; CaCl₂ (anhydrous), 0.014%; Na₂SiO₃·9H₂O, 0.007%; NTA (nitrilotriacetic acid), 0.007%; NaHCO₃, 0.15%; Trace element mix P II, 3% (v/v); Na₂HPO₄, 0.012%; glucose, 0.100%; L-arginine HCl, 0.007%; L-histidine HCl, 0.002%; L-lysine monohydrochloride, 0.007%; DL-phenylalanine, 0.005%; DL-methionine, 0.003%; DL-serine, 0.005%; DL-threonine, 0.006%; DL-leucine, 0.012%; DL-isoleucine, 0.004%; DL-valine, 0.005%; DL-glutamic acid monohydrate, 0.015%; DL-aspartic acid, 0.006%; DL- α -alanine, 0.005%; L-proline, 0.004%; L-hydroxyproline, 0.001%; glycine, 0.005%; L-glutamine, 0.01%; Na acetate, 0.005%; Vitamin mix 8a, 1.0% (v/v); cholesterol, 0.0002%; purine-pyrimidine mix II (~0.008%) and Tween 80, 0.002%.

For *Uronema marinum*, cultivated axenically by HANNA and LILLY (1970), the stock medium consisted of an *Ulva*-yeast autolysate, prepared by homogenizing 20 g of the common sea lettuce *Ulva lactuca* in a Waring blender with 200 ml of sea water. The yeast autolysate portion was prepared by suspending 25 g of Fleischmann's Dry Yeast in 100 ml of distilled water, and stirring constantly for 2.5 to 3 hrs at 50° to 60° C. The complete medium was made by combining the yeast supernatant, 50 ml, dextrose, 5.0 g, and proteose peptone (Difco), 5.0 g, with distilled water, 875 ml and *Ulva* homogenate, 75 ml. The medium was then adjusted to pH 7.6, dispensed in 5-ml quantities, and autoclaved at 120° C for 20 mins (see also Chapter 5.11, p. 1308).

Uronema marinum has nutritional requirements which differ from those of freshwater ciliates (HANNA and LILLY, 1971; LEE and co-authors, 1971b). HANNA and LILLY kept *U. marinum* for over 10 transfers in a defined medium base, supplemented with a partially purified fraction of brewer's yeast, and charcoal-filtered sea water. The defined components (expressed as $\mu\text{g ml}^{-1}$ of the final medium) were: L-alanine, 25; L-arginine, 100; L-aspartic acid, 50; glycine, 25; L-glutamic acid, 75; L-histidine, 50; L-isoleucine, 150; L-leucine, 150; L-lysine HCl, 125; L-methionine, 150; L-phenylalanine, 75; L-proline, 50; L-serine, 200; L-threonine, 150; L-tyrosine, 50; L-tryptophan, 50; L-valine, 75; guanylic acid, 75; adenylic acid, 30; cytidylic acid, 75; uridylic acid, 20; sodium acetate, 570; linoleic acid, 3.75; oleic acid, 1.25; stigmaterol, 2; calcium pantothenate, 6; nicotinamide, 4; pyridoxal HCl, 4; riboflavin, 4; folic acid, 4; thiamine HCl, 11.3; biotin, 0.0044; DL-6-thioctic acid, 0.014; $\text{MgSO}_4 \cdot 7\text{H}_2\text{O}$, 40; $\text{CaCl}_2 \cdot 2\text{H}_2\text{O}$, 20; $(\text{NH}_4)_2\text{SO}_4$, 10; $\text{CuCl}_2 \cdot 2\text{H}_2\text{O}$, 2; $\text{FeCl}_3 \cdot 6\text{H}_2\text{O}$, 0.5; $\text{MnCl}_2 \cdot 4\text{H}_2\text{O}$, 0.1; ZnCl_2 , 0.02; KH_2PO_4 , 570; K_2HPO_4 , 570. The crude supplements were prepared by suspending 10 g of brewer's yeast in 30 ml of distilled water, and steam distilled for 30 mins. The supernatant of the residue was then taken off and passed through a 0.45- μm Millipore filter, to yield approximately 100 ml of a deep amber opalescent fluid. When added to the defined base in a final concentration of 25%, this fraction promoted luxurious growth. The charcoal-filtered sea water was autoclaved separately and added aseptically in a final concentration of 15%.

Further nutritional studies on *Uronema marinum* have revealed strain differences (HANNA and LILLY, 1972, 1974). The strain initially isolated in axenic culture required a water-soluble extract of yeast cells which could not be replaced by defined components. A second strain, isolated from the same habitat, did not require the yeast factor. This strain was sustained in a synthetic medium which contained the following components (expressed as $\mu\text{g ml}^{-1}$): L-alanine, 100; L-arginine, 400; L-aspartic acid, 200; glycine, 100; L-glutamic acid, 300; L-histidine, 200; L-isoleucine, 600; L-leucine, 600; L-lysine HCl, 500; L-methionine, 600; L-phenylalanine, 300; L-proline, 200; L-serine, 800; L-threonine, 600; L-tyrosine, 200; L-tryptophan, 200; L-valine, 300; ribonucleic acid (sodium salt from yeast), 1000; biotin, 0.002; folic acid, 5.0; nicotinamide, 5.0; calcium pantothenate, 10.0; pyridoxal HCl, 5.0; thiamine HCl, 15.0; DL-6-thioctic acid, 0.1; calcium leucovorin, 1.5; stigmaterol, 2.5; cephalin, 100; Tween 80, 100. A final density of 1.015 was obtained by the addition of artificial sea water (Aqua Marine). The pH was adjusted to 7.2 with 1 N NaOH, and the complete medium was sterilized by autoclaving. Population densities of 200,000 individuals ml^{-1} were observed after 7 days at 24° C. HANNA and LILLY (1974) cultivated a strain of *U. marinum* in a chemically defined medium containing 17 amino acids, 4 nucleotides, 5 fatty acids, stigmaterol, 8 growth factors and artificial sea water. Increased population growth was obtained when either phosphate-inositol or Tween 80 were added to the medium. For further details on *U. marinum* and general prospects regarding the axenic cultivation of marine ciliates consult Chapter 5.11.

Other Species

FENCHEL (1968) determined rates of population growth for 9 benthic marine ciliate species: *Aspidisca angulata*, *Condylostoma patulum*, *Diophrys scutum*,

Euplotes vannus (p. 604), *Keronopsis rubra*, *Lacrymaria marina*, *Litonotus lamella*, *Uronema marinum* (p. 613), and an undescribed philasterid. All cultures were initiated with 2 to 12 individuals taken from logarithmic-phase cultures (with the exceptions of *C. patulum* and *Lacrymaria marina*, because their reproductive rates always decreased somewhat after several generations in pure culture, presumably due to some deficiency of micronutrients). The small-sized species (*U. marinum* and the philasterid) were cultivated in a drop of culture fluid placed between two cover glasses sealed with Vaseline; the other species were kept in Boveri dishes. Aged sea water (19‰S) was used as culture medium. Bacteria grown in peptone solutions were used as food source for *Aspidisca angulata*, *Euplotes vannus* and *Uronema marinum*; the diatom *Phaeodactylum* sp. for *Keronopsis rubra* and *Diophrys scutum*; *Dunaliella* sp. for *Condylostoma patulum*; and bits of living mussel tissue for the histophagous philasterid. The carnivorous *Lacrymaria marina* and *Litonotus lamella* were offered *U. marinum* taken from peptone cultures and rinsed in sea water before feeding.

(e) Suctoria

Suctoria seem to feed exclusively on living organisms, preferably ciliates. Details on cultivation of marine forms are not available. However, several accounts have been written regarding the cultivation of limnic representatives: *Podophrya collini* (ROOT, 1914; LILLY and co-authors, 1953; HULL, 1956; STERBENZ and LILLY, 1956; PALINCSAR, 1959); *Tokophrya infusorium* (RUDZINSKA, 1951; LILLY and co-authors, 1953; STERBENZ and LILLY, 1956). A brief review on nutrition of carnivorous protozoans has been presented by LILLY (1953). Methods comparable to those described for the above-mentioned freshwater suctorians may also work with marine forms. As the most recent information available, PALINCSAR's account seems adequate for outlining essentials.

Isolated from a drainage ditch, *Podophrya collini* stocks were maintained by PALINCSAR (1959) in Osterhaut's medium (pH 6-8) at 22° to 24° C or at 18° C; each individual was fed 2 to 4 *Tetrahymena pyriformis* every 48 hrs. *P. collini* was rendered axenic by extensive washing and exposure to antibiotics (penicillin G, K salt, 200 to 1000 units ml⁻¹ of Osterhaut's medium) and then cultured in sterile Syracuse dishes enclosed in cellophane bags.

Purified cultures received *Tetrahymena pyriformis* (2 per suctorian) or *Paramecium aurelia* (1 per suctorian) at different time intervals in order to investigate the causes underlying the frequently observed formation of structural abnormality (giant formation). The food organisms had been, for this purpose, pretreated with guanylic acid, 8-azaguanine, commercial DNA, or DNA from *T. pyriformis*. Giant formation of *Podophrya collini* increased after guanylic acid pretreatment; it diminished after 8-azaguanine pretreatment; it remained unaffected after DNA pretreatment over a 5-day test period. Giant individuals are incapable of reproduction and disintegrate after a few hours. Control of giant formation is important as a means to allow continued cultivation of dense suctorian populations. Being obligate carnivores, *P. collini* have, thus far, resisted all attempts to grow them at normal rates without living food ciliates. However, a bacillus, discovered as a contaminant of some *P. collini* cultures, seems to benefit their growth (PALINCSAR, 1959).

(f) Protozoa from Brine Habitats

EVANS (1958, 1960) cultivated a number of Protozoa from the Great Salt Lake (Utah, USA), the total salinity of which varies between 200 and 270‰, depending upon the water level. The protozoans belong to the genera *Cristigera*, *Cyclidium*, *Podophrya*, *Euplotes* and *Oikomonas*; in addition, a small amoeba and two unidentified ciliates were recorded. All of these, except *Podophrya* sp., which feeds upon *Euplotes* (see also REDDY and EVANS, 1971), appear to be bacteria feeders. *Cristigera* sp. grows well on most of 15 bacteria species isolated from the lake, producing a minimum of 3 and a maximum of 9 generations in 24 hrs. Maximum growth rates occur in 10 to 180‰S; population growth stops completely in 230‰S. Cysts of *Cristigera* sp., however, can survive long periods in saturated salt solutions. Preliminary tests on the other protozoans indicate that growth is inhibited at 150 to 180‰S. EVANS (1960) suggests that *Cristigera* sp. and the amoeba are halophilic, and that certain of the other species may be euryhaline, salt-tolerant freshwater forms. The amoeba has been cultivated on agar with mixed bacteria; it seems able to grow in saturated brine.

(g) Biochemical Interactions Among Cultured Protozoa

Protozoans—and other aquatic organisms—release into, and take up from, the ambient medium organic compounds which may affect metabolism, growth and reproduction of coexisting organisms. Such biochemical interactions between con- and heterospecifics are of considerable ecological interest. They are mediated, via the ambient medium, by substances collectively referred to as conditioners, allelocatalyzers (ROBERTSON, 1921, 1924), pheromones or ectohormones (KARLSON and BUTENANDT, 1959), probiotics (LILLY and STILLWELL, 1965), growth factors (LILLY, 1967), 'telemédiateurs' (AUBERT, 1971; PINCEMIN, 1971), or allelochemicals (WHITTAKER and FEENY, 1971). Biochemical interactions have been reported for a number of species and are expected to play an important role in the dynamics of multispecies systems (e.g. LUCAS, 1947; BURKHOLDER, 1952; FONTAINE, 1976; Chapter 6; see also Volume I: FOGG, 1972, p. 1558; WILBER, 1972, p. 1567).

In an attempt to define growth factors, LILLY (1967) includes in these (i) all vitamins, since they influence growth and development of certain micro-organisms and of metazoans; (ii) other chemical compounds which promote growth of protozoans, but have no observable influence on higher animals. He excludes (i) substances which provide the principal carbon or nitrogen sources of an organism, and (ii) inorganic compounds, even when required in extremely small quantities.

The first author to claim stimulatory effects of extracellular growth-promoting substances in protozoans, ROBERTSON (1921, 1924), experimented with species of the ciliate genera *Enchelys* and *Colpoda*. He coined the term 'allelocatalysis' to characterize the mutual stimulation observed. CUTLER and CRUMP (1923) and GAUSE (1934) were unable to confirm ROBERTSON's findings. However, these early investigations, using chemically undefined media and non-axenic conditions, invalidate conclusions about possible effects of conditioners.

Axenic *Chilomonas paramecium* were reported to release a heat-labile dialyzable substance which stimulated the reproduction of members of the same species (MAST and PACE, 1938). According to KIDDER (1941), *Tetrahymena pyriformis*

released 2 heat-labile substances, one accelerating population growth, the other inhibiting it. LILLY and co-authors (1961) obtained growth-promoting effects in ciliates cultivated in different kinds of crude media. When grown together, *Paramecium caudatum* and *Stylonychia pustulata* mutually stimulated their reproductive activities. The probiotics eliciting this response were heat-labile and non-dialyzable. EICHEL and co-authors (1963) discovered extracellular ribonuclease in the culture medium supporting *T. pyriformis* during its early phase of population growth. Comparable findings have been reported by ROTH (1963).

The growth-promoting substance released by *Colpidium campylum* was not as readily destroyed by heat as the conditioners produced by other protozoans; the substance exerted a significant allelocatalyzing effect on *Paramecium caudatum* (STILLWELL and LILLY, 1962). Cultivation of *C. campylum* under axenic conditions and in a chemically defined medium made it possible to separate the probiotic from the known components of the culture medium (STILLWELL and LILLY, 1964). The *C. campylum* probiotic elevated the rate of reproduction of *Paramecium caudatum* and various species of *Tetrahymena* (including *T. pyriformis*) by as much as 50% (LILLY and STILLWELL, 1965). This effect was lost when the conditioned medium was subjected to autoclaving (1 hr or longer) or to Seitz filtration. The active material was retained by membrane filters with porosities of 0.1 μm , but not by filters of larger (average) porosity. The separated material contained considerable amounts of protein. Ninhydrin tests were positive after acid hydrolysis of the residue (obtained by filtration) in 1 N HCl for 1 hr at 100° C; but this treatment did not destroy the probiotic effect. On the other hand, LILLY and STILLWELL (1965) report that alkaline hydrolysis with 1 N NaOH for 30 mins at 100° C results in complete destruction of the factor. By the use of a Sephadex column (G-25), it was possible to obtain active fractions after elution with 3 to 6 ml of phosphate buffer.

STILLWELL (1967) found the heat-stable probiotic of *Colpidium campylum* to be, at least in part, RNA, precipitable from the medium by acetone. Lipids and proteins or peptides were also present in the complex; these appeared to protect the RNA from chemical and physical agents. The greatest quantity of probiotic material was obtained from culture media which had been conditioned by *C. campylum* for 2 days. Thereafter, the quantity decreased until, after 5 days, almost no probiotic remained in the conditioned medium. Apparently, the probiotic was at its highest level during the logarithmic phase of *C. campylum*. However, *Chilomonas paramecium* released growth-promoting material which accelerated the growth of members of the same species (MAST and PACE, 1938); and the reproductive rate of *C. campylum* was slightly increased by its own probiotic (STILLWELL, 1962). Consequently, STILLWELL (1967) assumes that the production of the probiotic did not decrease in older cultures, but that *C. campylum* itself was using some of the material, thereby depleting the supply. Possibly, the probiotic is released from the cell during fission. This assumption is supported by the fact that the rate of reproduction was high during the logarithmic phase of population growth.

Considering the possible function of the *Colpidium*-RNA probiotic, STILLWELL (1967) points out that the lag phase, observed after a protozoan is placed in a new culture medium, may be indicative of a shock response. Possibly, the RNA probiotic primes some reaction, such as protein synthesis, temporarily halted by the

Table 5-16

Chemically identified substances which may promote cell growth and reproduction in protozoans (After a compilation by LILLY, 1967; modified; reproduced by permission of Academic Press)

Substance	Required by	Not required by	Comments
Thiamine	Almost all protozoans, except a few flagellates	A few flagellates such as <i>Chlamydomonas moewusii</i> , <i>Cryptomonas ovata</i> and <i>Polytoma uvella</i>	Some flagellates and one amoeba require only one component of thiamine, the thiazole or the pyrimidine portion
Vitamin B ₁₂	Many phytoflagellates, both photosynthetic and colourless; some amoebae	Ciliates: parasitic flagellates; some phytoflagellates	Euglenid flagellates respond to pseudo-B ₁₂ as well as to cyanocobalamin. <i>Ochromonas</i> does not respond to pseudo-B ₁₂
Riboflavin	All ciliates; the colourless euglenid <i>Peranema trichophorum</i> ; some amoebae	Phytoflagellates generally, except <i>Peranema</i>	Parasitic flagellates and malarial organisms grow in media with riboflavin but the actual need has not been determined
Vitamin B ₆ group	Ciliates, with few exceptions; <i>Trichomonas gallinae</i> and possibly other parasites	Free-living flagellates; a few rare species and strains of <i>Tetrahymena</i>	Pyridoxine is not very effective for ciliates. Pyridoxal and pyridoxamine are much more effective for <i>Tetrahymena</i>
Pantothenic acid	All ciliates; some parasitic flagellates	Free-living flagellates	The presence of pantothenic acid in many crude materials interferes with tests
Folic acid and pteridines	All ciliates; some parasitic flagellates including <i>Trichomonas gallinae</i> and <i>T. foetus</i> ; special pteridine requirement in <i>Critidia fasciculata</i>	Free-living flagellates	Folic acid (tetrahydrofolic acid) is apparently a special requirement for malarial organisms and certain hypotrichous ciliates

Nicotinamide	All ciliates; some parasitic flagellates including <i>Trichomonas gallinae</i> ; one mutant strain of <i>Chlamydomonas</i>	Free-living flagellates	Both nicotinic acid and nicotinamide are effective for most organisms tested
Biotin	Some chrysoomonads, such as <i>Ochromonas</i> ; some dinoflagellates, including species of <i>Amphidinium</i> , <i>Gyrodinium</i> and <i>Gymnodinium</i>	Other protozoans grown in chemically defined media	The presence of biotin in all crude materials makes it impossible to determine requirements unless all components of the medium are chemically defined
Thioctic acid (α -lipoic acid)	<i>Tetrahymena pyriformis</i> and other members of the family Tetrahymenidae	All flagellates capable of growth in chemically defined media	Requirement cannot be determined in chemically undefined media
Ascorbic acid (vitamin C)	Trypanosomatid flagellates (may not be true requirement)	All free-living protozoans	Growth of parasitic forms may be improved by a non-specific effect on the oxidation-reduction potential
Fat-soluble vitamins (vitamins E and K)	<i>Trichomonas gallinae</i> (stimulation of growth, but may not be a true requirement)	All other protozoans tested	Adequate testing of most fat-soluble vitamins has been precluded by methods used and species involved
Haematin	Some trypanosome species	All other protozoans tested	Possibly required by malarial parasites since blood cells are used to maintain organisms <i>in vitro</i>
<i>para</i> -Amino benzoic acid	<i>Plasmodium</i> species <i>in vitro</i>	All other protozoans tested	Small quantities of PAB counteract the inhibitory effect of sulphonamides
Choline	<i>Trichomonas gallinae</i>	All other protozoans tested	Information on the need for this substance is still incomplete
Quinones	<i>Oxyrrhizis marina</i>	Other protozoans	—
Sterols	E.g. <i>Oxyrrhizis marina</i> , <i>Paramecium aurelia</i>	Other protozoans tested	—

shock. This hypothesis was strengthened by the observation that the *Colpidium* probiotic did not stimulate reproduction of *Tetrahymena pyriformis* when introduced while the cultures were in the logarithmic or stationary phases of population growth.

Chemically identified substances which may promote cell growth and reproduction in various protozoans are listed in Table 5-16. These substances, especially the growth promoters among them, are assumed to be of general importance in cultivation: Failure to cultivate protozoans may have been due to lack of suitable allelocatalysis. The chemical substances involved may represent some of the 'cement' that provides for the presumably special linkages between ecosystem members. We must focus our attention more on chemical interactions among coexisting forms of life and select potential culture partners carefully from a variety of organisms (bacteria, yeast, unicellular algae, protozoans, etc.) known, or expected, to synthesize and to release essential chemical compounds. Experiments involving the addition of defined strains of donor organisms, or of their products, to the culture medium should yield rewarding results.

Chemical interactions among coexisting organisms, mediated through the ambient water, have been analyzed sufficiently in few cases only—too few for drawing detailed conclusions. The major interactions described can be subdivided into 3 categories: **cooperation** (syntrophy, symbiosis), involving uni-, bi- or multi-factorial promotion among coexisting organisms; **antagonism** (antibiosis), comprising uni-, bi- or multifactorial inhibition (including autoinhibition); **stimulation**, eliciting or modifying significant life processes, such as hatching, setting, metamorphosis, reproduction and orientation in space and time (Volume II). Special antagonistic effects among marine organisms are exemplified by the vitamin B₁₂ binding factor discussed at some length in an interesting paper by DROOP (1968).

(h) Protozoa as Assay and Food Organisms

Very few marine ciliates have, this far, been used as assay organisms for determining environmental quality. Although several pertinent research projects have been brought to the attention of the reviewer, the published information is disappointingly meagre. Here is fertile ground for experimental marine ecologists engaged in environmental protection. The importance of ciliates in domestic and industrial water purification has been investigated in numerous studies (e.g. BICK, 1964, 1972; BICK and KUNZE, 1971; BICK and BERTRAM, 1973; RUTHVEN and CAIRNS, 1973). Nutrient regeneration and plankton trophodynamics have received attention from JOHANNES (1965), GOLD (1968), PAVLOVSKAYA (1969) and others.

Cryptocodinium cohnii has been used as assay organism for thiamine (PROVASOLI and GOLD, 1959; GOLD, 1973), for biotin (PROVASOLI and GOLD, 1959), and as a biochemical research tool. *Monochrysis lutheri*, a euryhaline B₁₂-requiring phytoflagellate (Chapter 4.1), yielded useful information on the B₁₂ content of sea water (DROOP, 1955). HUTNER (1964) presented an account on Protozoa as toxicological tools (see also HUTNER and co-authors, 1961).

Cristigera spp.—common, bacterivorous, sediment-living ciliates—have been used as toxicity indicators for heavy metals (GRAY and VENTILLA, 1973). Under near-optimum conditions of temperature and salinity, the effects of mercuric ions,

HgCl₂, lead ions, Pb(NO₃)₂, and zinc ions, ZnSO₄, were analyzed at 3 concentrations in a 3³ factorial design. HgCl₂ at an added concentration of 0.0025 ppm reduced growth rate by 9.7%; Pb(NO₃)₂ at 0.15 ppm, by 8.5%; ZnSO₄ at 0.125 ppm, by 8.3%. On mixing the chemicals, significant synergistic effects were found.

While the potential importance of protozoans as food for other cultivated animals, especially young stages (larvae) of fishes, has been referred to by several investigators (e.g. STERBA, 1967; BARNABÉ, 1974; FLÜCHTER, 1974; RENÉ, 1974), detailed information regarding marine species is rare.

DE WINTER and PERSOONE (in press) and KAHAN and co-authors (in press) have suggested that the euryplastic *Fabrea salina* (size range: 200 to 400 μm) provides excellent food for a variety of invertebrates and fishes. *F. salina* cultures thrive at high temperatures (37° to 40° C) in sea water, but the ciliate remains alive and may be offered as food under a large variety of temperature and salinity conditions. From mass cultures, *F. salina* can be easily harvested by applying light gradients (phototaxis) or electrical currents (galvanotaxis). Dormant stages (cysts) and excysting of stored cysts can be produced at will by environmental change (DEMAR-GERVAIS, 1971). The ciliates move rather slowly and should be easy prey even to clumsy predators; in aerated tanks, they remain distributed throughout the water column; their nutritional value seems adequate for numerous animals. KAHAN and co-authors further point out that the nutritional value can be controlled to a certain extent by the food offered to *F. salina* and by using its food vacuoles for administering selected substances to the animals that feed on this ciliate (see also p. 604).

(i) Protozoa: Conclusions

Information about the broad field of protozoan cultivation is widely scattered throughout the literature. Interest in cultivating Protozoa has, thus far, originated primarily with physiologists, biochemists and geneticists. Members of several protozoan groups have been used with much success as 'laboratory animals'. These forms yielded interesting and important information regarding the basic environmental and nutritive conditions required for cell growth and reproduction, as well as on a variety of specific intracellular functions. Few culture methods have been designed with a view to provide ecologically meaningful conditions or with the aim of obtaining ecologically valid data.

Ecologically oriented interests in the cultivation of heterotroph, free-living marine Protozoa have largely concentrated on studying population dynamics and nutritional requirements. Responses to variations in environmental factors and inter-specific ecological dynamics received much less attention than is necessary for a sound assessment of the ecological role which protozoans play in marine environments. Ubiquitousness, nutritional diversity and high physiological adaptiveness, as well as small size, short generation time and high metabolic rates, convey to the Protozoa characteristics of considerable ecological importance and make them excellent tools for investigating ecological problems. Among the marine protozoans, zooflagellates, foraminiferans, ciliates and radiolarians presumably contribute essentially to the ecological dynamics in oceans and coastal waters. While marine radiolarians have hardly yet entered the laboratories of experimental ecologists,

Table 5-17
 Summary of important culture methods developed for marine zooflagellates (Compiled from the sources indicated)

Species	Remarks	Food	Medium	Author
<i>Acanthoecopsis</i> sp.	Photoperiod: 18 hrs light, or complete darkness; 10° C	Organic matter; Tables 5-1, 5-2	Tables 5-1, 5-2	GOLD and co-authors (1970)
<i>Amphidinium höferi</i>	Photoperiod: 12 hrs light; illumination: 270 to 870 lux; 16° C	Table 5-3	Modified. DROOF (1958). Medium, Table 5-3	ELBRÄCHTER (1972)
<i>Cryptocodinium cohnii</i>	Optimum temp.: near 30° C; artificial sea water (Table 5-4)	P. 588; Table 5-4	SW Ph II medium (PROVASOLI and co-authors, 1957); Tables 5-4, 5-5	PROVASOLI and GOLD (1962) GOLD and BAREN (1966) KELLER and co-authors (1968)
<i>Diaphanoeca grandis</i>	Photoperiod: 18 hrs light, or complete darkness; 10° C	Organic matter; Table 5-1	Table 5-1	GOLD and co-authors (1970)
<i>Noctiluca miliaris</i>	Optimum temp.: near 20° C; sterile sea water	<i>Platymonas</i> sp., mixture of phytoflagellates	Sea water; heat-sterilized medium, P. 591	GROSS (1934); MCGINN and GOLD (1969); GOLD (1970); UHLIG (1972a); ECKERT (1965); MCGINN (1971)
<i>Oxyrrhis marina</i>	Optimum conditions: 22-5° C; 16‰S; pH 8 to 10; extremely euryhaline: 4 to 64‰S	Various unicellular algae, e.g. <i>Nannochloris oculata</i> ; yeast <i>Saccharomyces exiguus</i>	P. 591	BARKER (1935), DROOF (1953, 1958, 1959a, 1963, 1966a); DROOF and DOYLE (1966); DROOF and PENNOCK (1971)

detailed culture methods have been developed for a few members of the other groups: for 6 species of zooflagellates (Table 5-17), 7 species of foraminiferans, and 20 species of ciliates (Table 5-18); only two species of marine amoebae have thus far been successfully cultivated.

Essential steps of Protozoa cultivation include: (i) careful collection and immediate transportation to the laboratory (avoid overcrowding and thermal or mechanical shocks); (ii) accumulation and isolation, e.g. by employing electric currents, light gradients, decantation, pipetting, sieving, selective sedimentation, centrifugation, migration, elutriation or interphase accumulation (for details consult pp. 218 to 222); (iii) if desired, further isolation by manipulative separation and/or application of antibiotics; (iv) analysis of nutritional requirements and exploration of long-term sustenance conditions.

Protozoans provide good experimental material for studies on chemical interactions between co- and heterospecifics. Organic compounds released into, and taken up from, the ambient medium may affect intra- and interspecific population dynamics. Details of the substances involved (referred to as conditioners, allelocatalyzers, probiotics, growth factors, telemediateurs, etc.) and of the responses elicited remain to be investigated. In some species, conditioners may be essential for normal metabolic performance; in others, the presence or absence of such substances may significantly affect organismic responses, e.g. to the environmental factors examined. Hence, for breakthroughs in the cultivation of protozoans—and possibly of other marine animals—chemical interactions between coexisting organisms, mediated by the surrounding medium, appear to be of considerable importance.

Very little information has come to the reviewer's attention on protozoans as assay organisms. This is surprising since protozoans should make excellent assay material for several reasons: (i) Their small size facilitates operation in space-saving, easy-to-handle culture systems and makes it possible to conduct statistical studies at the population level. (ii) Rapid growth and short generation times help to save time. (iii) Asexual reproduction yields clones of identical genetic constitution for comparative studies. (iv) Material of known genetic and environmental background can be held ready in stock cultures. (v) Protozoan cultures make good 'building blocks' for composing multispecies cultures and experimental microcosms (Chapter 6). The controlled construction of organismic assemblages may provide insight into the processes which govern coexistence and allow assessment of the degree of resistance of multispecies assemblages to environmental stress—both natural and man-made.

While protozoans have been used in several cases as food for cultured marine animals, notably larvae of crustaceans, molluscs and fishes, the information at hand is largely restricted to general statements and often suffers from lack of taxonomic identification, and of details both on mass-culture methods and food values. An example of a potentially very important food organism is *Fabrea sakima* (p. 604). This heterotrichous ciliate is euryplastic, remains well distributed over the water column, can easily be caught by a large variety of predators, has a high nutritional value, and can be conveniently stored in the form of cysts (e.g. KAHAN and co-authors, in press; DE WINTER and PERSOONE, in press).

The nutritional requirements of protozoans are more diverse and sometimes

Table 5-18
 Summary of important culture methods developed for marine ciliates (Compiled from the sources indicated)

Species	Remarks	Food	Medium	Author
<i>Condylostoma</i> sp.	Continuous light; 18° to 29° C; 36‰S; minimum generation time: 0.7 day	Mixture of <i>Dunaliella salina</i> , <i>D. tertiolecta</i> , <i>D. primolecta</i>	'Walne' medium	KAHAN and co-authors (in press)
<i>Diafolliculina rotunda</i>	The harpacticoid copepod <i>Tisbe holothuriae</i> was used as culture partner	<i>Dunaliella</i> sp. <i>Cryptomonas Cryptomonas</i> sp.	Seitz-filtered sea water	ÜHLIG (1965)
<i>Eufolliculina</i> sp.	The harpacticoid copepod <i>Tisbe holothuriae</i> was used as culture partner	<i>Dunaliella</i> sp. <i>Cryptomonas</i> sp.	Seitz-filtered sea water	ÜHLIG (1965)
<i>Euplotes antarcticus</i>	Total range of infinite survival: -2° to 10° C; generation time see Fig. 5-1	Bacteria	E ₂ medium (GOLD, 1964)	LEE and FENCHEL (1972)
<i>E. balteatus</i>	Total range of infinite survival: 5° to 40° C; generation time see Fig. 5-1	Bacteria	E ₂ medium (GOLD, 1964)	LEE and FENCHEL (1972)
<i>E.</i> sp.	22° C; 33‰S 26° C; 36‰S Generation time: 10 to 11 hrs	Bacteria <i>Aerobacter aerogenes</i> plus 0.3% lettuce broth	Sea water Sea water	LUEKEN (1973) KAHAN and co-authors (in press)
<i>E. vannus</i>	20° to 25° C; 20, 25, 30 or 35‰S. Mean cell division rate: 12 hrs Total range of infinite survival -2° to 30° C; generation time see Fig. 5-1	Baker's yeast (10,000 to 20,000 cells in 5 ml of medium) Bacteria	Sea water, brackish water E ₂ medium (GOLD, 1964)	PERSOONE and DEFLAECIE (1972) LEE and FENCHEL (1972)

<i>Fabrea salina</i>	Continuous light; 37° and 40° C, 36‰S; minimum generation time: 6 hrs Reproduces up to 30° C and up to 100‰S. Mass cultures in raceways and polyethylene bags	<i>Dunaliella parva</i> , <i>D. primolecta</i> , <i>D. salina</i> , <i>D. suecica</i> , <i>D. tertiolecta</i> Dry foods such as yeast. <i>Dunaliella viridis</i>	'Walne' medium Sea water	KAHAN and co-authors (in press) DE WINTER and PERSOONE (in press)
<i>Favella campanula</i>	Photoperiods of varying lengths (up to 300 ft.c.); 20° C; sea water. Older cultures failed to conjugate	Phytoplankton and the dinoflagellates <i>Glenodinium foliaceum</i> , <i>Peridinium trochoideum</i>	E ₂ medium (GOLD, 1964)	GOLD (1969b)
<i>Keronopsis rubra</i>	Natural day light; 23° C; 34‰S 18° to 27° C; sea water generation time: 1 to 2 days	Bacteria from decomposing lettuce Bacteria developing on grains of wheat, rice, etc.; <i>Dunaliella tertiolecta</i> , <i>Phaeodactylum tricorneratum</i>	Sea water Sea water	WALKER (1975) KAHAN and co-authors (in press)
<i>Metafolliculina</i>	The harpacticoid copepod <i>Tisbe holothuriae</i> was used as culture partner	<i>Dunaliella</i> sp. <i>Cryptomonas</i> sp.	Seitz-filtered sea water	UHLIG (1965)
<i>Miamiensis avidus</i>	Maximum population growth: 22° to 27° C; sea water	Tables 5-11, 5-12, 5-13	C-, M-, and S-medium; for details see p. 607	SOLDO and MERLIN (1971, 1972)
<i>M. sp.</i>	Maximum population growth: 22° to 27° C; sea water	See Tables 5-11, 5-12, 5-13, 5-14	C-, M-, and S-medium; for details see p. 607	SOLDO and MERLIN (1971, 1972)
<i>Paramacium calkinsi</i>	Brackish water; artificial sea water	P. 610	P. 610	DICKERSON and co-authors (1963), NAPOLITANO and LILLY (1972)
<i>Parauronema virginianum</i>	Maximum population growth: 22° to 27° C; sea water of 1.010 density	Tables 5-11, 5-12, 5-13, 5-14	C-, M-, and S-medium for details see p. 607	SOLDO and MERLIN (1971, 1972)

Table 5-18—Continued

Species	Remarks	Food	Medium	Author
<i>T. inimopsis boroidea</i>	12-5° C; requires special conditions during conjugation	Bacteria-free unicellular algae	See <i>T. tubulosa</i>	GOLD (1971a, b, c)
<i>T. tubulosa</i>	10° to 12° C; sea water	Yeast; mixture of <i>Rhodomonas lens</i> , <i>Isochrysis galbana</i> , <i>Platymonas tetrahele</i> , etc.	Modification of DC medium (PROVASOLI and co-authors, 1957); see Table 5-15	GOLD (1968, 1969b)
<i>Uronema marinum</i>	Mainly sustained under axenic conditions (see also Chapter 5-11)	<i>Pseudomonas</i> sp. for details consult pp. 613, 614	Pp. 614, 1309	LEE and co-authors (1971) HANNA and LILLY (1970, 1971, 1972, 1974)
<i>U. nigricans</i>	Maximum population growth: 22° to 27° C; sea water of 1.010 density	Tables 5-11, 5-12, 5-13, 5-14	C-, M-, and S-medium for details see p. 607	SOLDO and MERLIN (1971, 1972)
<i>U. sp.</i>	Subdued light; optimum temperature: 25° C; artificial sea water; optimum salinity: between 17 and 43‰	Bacteria, e.g. <i>Serratia maritima</i>	Algal medium (GUILLEARD and RYHER, 1962); artificial sea water	HAMILTON and PRESLAN (1969)

more specific than originally assumed. Historically, investigations on nutritional requirements are characterized by increasingly well-defined culture conditions. Early investigators employed raw media (e.g. hay, meat, soil extracts) and agnotobiotic cultures, containing members of several unknown species in addition to the organisms actually cultivated. Gradually, chemically poorly defined oligic media were replaced by holidic media in which all nutrient components are chemically defined, and the originally agnotobiotic cultures were turned into axenic cultures with members of only 1 species. Chemically defined media and axenized cultures allow exact differentiation between essential and non-essential nutrients. However, such rigidly controlled and defined conditions deviate from those prevailing in the natural environment, and, hence, may produce functional and structural responses that differ from those exhibited in the unconstrained natural environment.

(3) Porifera

The most primitive multicellular animals, Porifera have both fascinated and challenged experimental ecologists. Sponges are fascinating because their cells exhibit greater independence than those of any other multicellular animal; they are challenging because it is so difficult to provide them with definable nutritional conditions. Often easy to cultivate under *in situ* conditions, in running, unfiltered sea water, or in large public aquaria, isolation of sponges under controlled nutritional conditions has remained a problem. Most of the Porifera brought into laboratories have died soon after collection.

The members of the phylum Porifera inhabit marine or brackish-water, except for the two families Spongillidae and Potamolepidae which live in fresh water. Where substrata suitable for attachment (e.g. rocks, shells, coral, wood, sediment) are available, sponges often abound. Various aspects of the biology of Porifera have been dealt with in a book edited by FRY (1970). In this book, MERGNER (1970) has reviewed the techniques employed in the culture of freshwater living spongillids.

Porifera reproduce asexually by budding (for review see BRIEN, 1968). External buds are produced in the depths of the mesenchyme by aggregating amoebocytes; they migrate to the sponge's surface and finally fall to the ground as small sponglets. Internal buds (e.g. gemmulae) form from basal mesenchyme. Spicule-surrounded masses of archaeocytes, the gemmules may be produced throughout the growth period. They occur most frequently in freshwater sponges and represent a life-cycle stage with increased resistance to environmental stress (e.g. RASMONT, 1968b). Comparable stages, also referred to as reduction bodies (small aggregates of essential cells) are known from most sponges studied. They reorganize and germinate when more favourable conditions become available. Most sponges are hermaphrodites, but a few are dioecious. During sexual reproduction, eggs and spermatozoa develop from archaeocytes, amoebocytes or choanocytes. Released via exhalent water currents, spermatozoa enter neighbouring sponges with inhalent currents and, in the flagellated chambers, enter a choanocyte. The latter carries the spermatozoa to an egg where cell fusion, sperm migration and fertilization occur. During the breeding season, numerous eggs and larvae can often be seen within the sponge's body.

Annual changes in functions and structures have been reported by SIMPSON (1968) from intertidal populations and laboratory cultures of *Microciona prolifera*. During winter, flagellated chambers, canals, subdermal spaces, dermal membranes, fibre cells, endopinacocytes and choanocytes are absent and no growth can be recorded. Overwintering begins as the temperature decreases to 10° C or below; normalization occurs in spring when the temperatures rise above 10° C. Simultaneously with the tissue reorganization in spring, eggs are produced from archaeocytes. Spermatozoa production begins near 15° C.

Phylogenetically, the Porifera appear to have adapted early and perfectly to their ecological niche. Fossil remains indicate the absence of significant evolutionary changes over thousands or even millions of years. Major ecological assets of sponges are (i) low metabolic requirements and efficient retention of very small suspended particles that cannot be used by most other coexisting organisms; (ii) ability to survive extreme environmental stress in the form of reduction bodies; (iii) high capacities of regeneration; (iv) efficient counteraction of intruders such as pathogenic bacteria, parasites or commensals; (v) unattractiveness as food source to most other marine animals.

Porifera exhibit high efficiencies of energy cycling and may participate appreciably in the consumption and production of organic matter. REISWIG (1974) estimates the consumption of coral fore-reef sponge populations in Jamaican waters to be 3.94 g organic matter m⁻² day⁻¹. In the light of the local production available,* this implies that most of the net production of deeper communities and much of that of shallow coral communities on the north coast of Jamaica are trapped. Niche partitioning among sponges is, according to REISWIG, based on differences in energy channelling and reproduction, rather than on nutritional specialization. Aspects of feeding in sponges have been reviewed in Volume II: PANDIAN (1975) and Volume IV: CONOVER (in press).

(a) Nutrition

Detailed studies on nutritional requirements of the Porifera have not yet been conducted. Nevertheless, numerous studies testify that sponges are primarily suspension feeders. They are specialized for filter feeding on suspended, fine-particulate organic matter. Bacteria, very small detritus particles and minute phytoplankters are assumed to constitute their main food sources. Presumably, many sponges also entertain metabolic exchanges with symbionts, such as bacteria and unicellular algae. In addition, they may be able to make use of dissolved organic substances. However, this possibility remains to be investigated.

About 30 papers have been published on uptake and retention of suspended particles by Porifera. In most cases, non-nutritive materials (e.g. carbon, carmine, India ink) or 'non-natural' particles (e.g. starch, powdered blood, milk, meat, eggs) have been used. Following COTTE (1903), TRIGT (1919), POURBAIX (1931, 1932a,

* 24 g OM m⁻² day⁻¹ for primary productivity of the upper reef crest (ODUM and ODUM, 1955); 2.7–10.2 g OC m⁻² day⁻¹ for Florida reef corals (KANWISHER and WAINWRIGHT, 1967); 4 g OC m⁻² day⁻¹ for a coral-rich transect of the Eniwetok reef (JOHANNES and co-authors, 1972).

b, 1933a, b), VAN WEEL (1949), KILIAN (1952) and JØRGENSEN (1955), most investigators have concluded that small particles (e.g. $\leq 5 \mu\text{m}$) are retained and taken up by choanocytes, larger particles (5–50 μm) by amoebocytes or related cell types. While KILIAN (1952, 1964) failed to sustain limnic spongillids on live bacteria, RASMONT (1961, 1963) obtained lasting growth and gemmulae formation in *Ephydatia fluviatilis* fed on a diet of killed *Escherichia coli*. According to RASMONT (1968a), individual bacteria are captured mainly by choanocytes; they are transferred to other cells and finally digested in archaeocytes; bacterial aggregates are liable to be phagocytized by pinacocytes, collencytes or archaeocytes.

Natural food sources utilized by marine sponges have been examined by REISWIG (1971a; see also 1971b, 1973, 1974). Employing SCUBA techniques, REISWIG (1971a) studied 3 species of Demospongiae: *Tethya crypta*, *Verongia gigantea* and *Mycale* sp. The 3 species are important members of Jamaican coral-reef communities. They offer large, single oscula for experimental water sampling. Collecting the water from near the inhalent sponge surfaces (ambient water) and from the oscular stream (exhalent water), REISWIG analyzed each sample for plankton by direct microscopy, and for particulate organic carbon (POC) by chemical analysis. Differences between ambient and exhalent samples provided information on the degree of retention of suspended particles and on the diets consumed. The net POC diet of all 3 sponges consisted of 80.5% of filtrable organic matter which is unresolvable by direct microscopy. Microscopically resolvable particulate matter (MPOC) accounted only for the remaining 19.5% of the POC uptake. The 3 sponges retained MPOC within the size range of 0.3 to 50 μm at high efficiencies (79% by calculated carbon content and 82% by particle volume). Major components of MPOC and of total POC were, respectively: unarmoured cells 83%, 16.2%; armoured cells (fungi, diatoms, dinoflagellates, coccolithophores, etc.) 12.3%, 2.4%; bacteria 4.6%, 0.9%. According to REISWIG, two retention systems appear to be operative: (i) capture of particles between 5 and 50 μm by phagocytosis of cells lining the inhalant canals; (ii) capture of small particles (0.3–1 μm) involving the choanocyte collar and ingestion by choanocytes. Bacterial retention is high in all 3 species (95 to 97% by cell number). All sponges examined produce detrital MPOC. In Jamaican waters, the microscopically unresolvable organic matter represents an available carbon source 7 times that of all microscopically resolvable planktonic material. The ability to capture this material and its abundance explain why sponges are the dominating suspension feeders in coral reefs. At the same time, REISWIG's results offer an explanation for the fact that it has been difficult, or impossible, to isolate Porifera for extended periods of time in controlled culture systems.

Studies on energy balance suggested to REISWIG (1974) that *Verongia gigantea*, in contrast to the other two species, depends upon inputs of significant amounts of 'dissolved' material—presumably through bacterial symbionts. Dissolved products from coral zooxanthellae are assumed to be either captured directly by bacterial symbionts (*Verongia* species) or converted to particulate matter via the route suggested by SOROKIN (1971; see also Volume IV: CONOVER, in press; SOROKIN, in press).

While *Mycale* sp. maintained constant levels of water transport, *Verongia gigantea* underwent periodic cessations averaging 42 mins at random intervals

of about 19 hrs. Shallow-water *Tethya crypta* revealed a synchronized diurnal cycle of contraction and dilatation, probably related to the diurnal rhythm of illumination (REISWIG, 1971b). The stormy season brought all members of the *T. crypta* population into functional synchrony with approximately biweekly storms.

(b) Laboratory Culture Experiments

Numerous sponges, often cultured only for short periods, have served as material for investigating fundamental biological problems. Among the most intensively studied aspects are cell differentiation, embryogenesis, morphology (primitive nerve elements, skeleton formation), regeneration and fusion of dissociated cells, transplantations (graftings), protective responses to commensals and parasites, as well as associations between sponges and bacteria and/or unicellular algae. Especially in the USSR, France and the USA, have such studies been pursued with considerable effort and for many years. For details consult the literature compilation by WARE (1968) and the review on sponge research in France by EFREMOVA (1973).

Unfortunately, in the majority of papers no, or only very little, information has been presented on cultivation methods. Because they turned out to be very sensitive to controlled laboratory conditions, most sponges have been used for short-term experiments immediately after collection.

Early short-term culture experiments on sponges have been conducted on *Halisarca dujardini* by LIEBERKÜHN (1859); on *Leucandria aspera*, *Leucoselenia lieberkühni*, *L. primordialis*, *Sycon raphanus* and *S. setosum* by SCHULZE (1878), MAAS (1894, 1900, 1904, 1906, 1907, 1910, 1912) and BIDDER (1923); on a large variety of different species by VON LENDENFELD (1889), who offered substances to the test sponges such as carmine, starch, milk or toxins in order to investigate particle retention and responses to toxic materials; on *Aplysia aerophoba*, *Chalinula fertilis*, *C. montagui*, *Euspongia irregularis* var. *mollior*, *Hircinia variabilis*, *Reniera simulans*, *Spongelia elastica* var. *massa*, *Stelospongia cavernosa* var. *mediterranea*, *Stylotella heliophila* and *Suberites massa* by LOISEL (1898), COTTE (1903) and PARKER (1910); on *Suberites massa* (oxygen consumption) by PÜTTER (1914); on *Cliona stationis*, *Erylus mammillaris*, *Oscarella lobularis* (e.g. NASSONOV, 1924). Short-term experiments on sponges and sponge larvae have also been conducted by ARNDT (1930, 1933). One of the easiest-to-maintain sponges appears to be the Mediterranean *Raspailia viminalis*.

The laboratory culture experiments conducted on members of the phylum Porifera may be grossly considered under four aspects: growth from explants, from eggs or larvae, from reduction bodies, or from artificially dissociated cells.

Growth from explants (cuttings) has been obtained, for example, by SIMPSON (1963, 1968), who studied several sponges (e.g. *Microciona prolifera*, *M. spinosa*, *Tedania ignis*, *Thalysias juniperina* and *T. schoenus*). Making use of the incredible capacities of sponges for regeneration, SIMPSON applied the cut surface of explants to a glass substrate with the original outer surface of the sponge uppermost. Explants were tied to glass slides which were then placed in running sea water, or in modified slide boxes hung off a dock. Later, SIMPSON (1968) placed explants of

M. prolifera in large basins which, in turn, were accommodated in constant temperature baths. In these cultures, the water was changed every other day, and a mixture of log-phase algal-culture suspensions (*Dunaliella euchlora*, *Isochrysis galbana*) were added as food source.

Eggs or larvae have mostly been obtained from newly collected breeding specimens. Depending on the species, illumination, temperature and/or water movement seem to act as the most important stimuli for larval release. In some species (e.g. *Oscarella lobularis*), larval liberation occurs predominantly at night, in others at dawn or during the day. Usually, the larvae are ejected with considerable force via exhalent water currents—often by thrusts, with pauses in between. Immediately upon liberation, the larvae swim towards the water surface. For details on larval behaviour in Demospongiae, consult BERGQUIST and co-authors (1970).

Formation of reduction bodies and subsequent growth from these bodies has been studied by WILSON (1907) in *Stylotella heliophila*. WILSON transferred active sponges to aquaria or concrete tubs not exposed to direct sunlight. Supported by bricks well above the bottom, 6 normal-sized sponges were accommodated in a 60-cm diameter and 30-cm deep container. After the containers were emptied, filled and flushed for some minutes 3 times per day, reduction began within a day or two. Within 2 or 3 weeks, many small living cell masses (1 to 1.5 mm diameter) had formed. Spheroid or of irregular shape, the reduction bodies measured a few mm in diameter; they consisted of masses of fused cells (syncytium), sometimes exhibited slow amoeboid movement, and resembled the gemmulae of freshwater sponges (WILSON, 1908). If enclosed in bolting cloth bags and hung in a live box floating in the sea, many of these reduction bodies quickly transformed into small sponges. With proper water supply, such reactivation can also be induced in the laboratory. MAAS (1910) stimulated gemmulae formation in cultured *Sycon raphanus* by exposing the sponges to artificial sea water without calcium.

Growth from artificially dissociated cells has been pioneered by WILSON (1907, 1910, 1937). For his 'fusion experiments', WILSON cut a sponge (e.g. *Microciona prolifera*) into small portions of ca 3 mm diameter. These were collected in fine bolting cloth, partially immersed in filtered sea water. The cloth was then folded and repeatedly squeezed with forceps so that single cells passed through the cloth mesh into the surrounding sea water. The cells sank and accumulated on the bottom from where they were pipetted on a suitable substratum (slide, cover glass, oyster shell), immersed in a culture dish. In the absence of vibrations, the cells began to attach themselves within about 1 hr. The slides were now carefully lifted, held vertical (this increases the contact between cells and substrate) and transferred to a larger container with slowly running sea water. Permanent attachment usually takes place by means of a coarse reticulum. Within a few days after metamorphosis, small incrusting sponges form with functional canal systems. Provided the running sea water contains adequate amounts of food particles, such cultures can easily be kept for long periods of time. They may also be transferred to *in situ* conditions. WILSON has obtained lobular outgrowths and even embryos in sponges obtained in this way.

WILSON's (1907) work and subsequent studies by HUXLEY (1921), GALTISOFF (1925) and HUMPHREYS (1963) demonstrated that if cells from sponges of different species are mixed, cell aggregations form which are composed of cells of a single

species. Such selective reaggregation seems to be based on species-specific, chemical-orientation mechanisms. Alternatively, it could also result from adhesion of con-specific cells upon chance encounter. However, the latter possibility has been ruled out for *Halichondria panicea*, *Microciona fallax* and *Suberites ficus* by CURTIS (1970), who employed the Couette viscometer (rotational, laminar shear flow) in order to produce random intercellular collisions. CURTIS found no evidence for specificity of adhesion. He suggests that there is no synthesis of a substance required for cell adhesion during aggregation and that there exist no metabolic interactions between cells which might affect their adhesiveness.

Cliona celata

The boring sponge *Cliona celata* has been cultivated by WARBURTON (1958a, b). Growth from larvae was obtained in a wooden, asphalt-lined aquarium receiving a constant flow of unfiltered sea water. Under these conditions, ripe *C. celata* discharged tens of thousands of eggs from a large osculum within a few hours. The sticky eggs adhered to each other and to solid substrates, forming irregular flattened masses. Diatoms, silt and other debris rapidly accumulated on and in the egg masses, thereby delaying the freshly hatched larvae in their escape to open water. During their wanderings, the larvae sometimes fused. Compound, fused larvae show no polarity or locomotory directivity, performing ineffective gyrations. Many perished within the tangle of debris. However, a few escaped and metamorphosed successfully into single sponges.

During his studies on the boring process of *Cliona celata*, WARBURTON (1958a, b) was able to keep specimens alive indefinitely in running sea water. He broke up sponge-infested shells of *Crassostrea virginica* and other molluscs with bone-cutting forceps. The exposed sponge masses were then scraped off with a blunt scalpel, and fragments of about 0.05 ml volume were transferred into a finger bowl containing filtered sea water; here, they were left for a few minutes to remove loose cells. Finally, the fragments were pipetted on a cover glass placed in a second finger bowl. If large sponge fragments could not be procured, several small ones were piled together. WARBURTON left the cultures undisturbed for 3 or 4 days without change of water. Thereafter, the fragments reaggregated and attached themselves so firmly to the substratum as to permit daily transfer to new sea water in clean dishes. Within 2 or 3 weeks, the sponge tissue flattened into discs—about 1 mm thick at the centre and with a maximum diameter of 15 mm—and developed a complicated system of excurrent canals with oscula.

Hippospongia equina

Larvae of *Hippospongia equina* var. *elastica* have been raised under laboratory conditions by ALLEMAND (1906). Freshly liberated larvae swim about for up to 5 days. They require oxygen-saturated running water, and can be kept in aquaria arrangements such as the one illustrated in Fig. 2-98 (p. 185). The optimum temperature for larval development of *H. equina* var. *elastica* is 17° C. For adults, suitable substrates (e.g. pieces of mollusc shells) must be provided.

Leucosolenia complicata

In cultured *Leucosolenia complicata*, JONES (1957) studied healing and regeneration processes. He removed oscular tubes and bisected them longitudinally with fine scissors. The pieces were then placed in Petri dishes containing 40 ml of sea water of 15° to 20° C.

Lissodendoryx carolinensis

The ciliated larvae of *Lissodendoryx carolinensis* can easily be made to fuse with one another when they move about on the bottom of a culture dish prior to attachment (WILSON, 1907). Coaxing them together with needle and pipette in a deep watch glass, yields 'compound larvae' with reduced locomotory activities. Nearly motionless pairs can be fused to cake-like masses measuring 3 to 4 mm in diameter. While smaller masses metamorphose without difficulty, large assemblies usually die, sometimes after partial metamorphosis.

Microciona prolifera

Using artificially dissociated cells (p. 631) of *Microciona prolifera*, GALTISOFF (1923, 1925) established that cellular reaggregation is accomplished by amoeboid movement of archaeocytes (unspecialized mesenchyme cells). Upon separation, archaeocytes creep in various directions and coalesce with other cells of con- or heterospecifics which happen to lie on their route. Physiological aspects of dissociated-cell reaggregation in sponges have been studied by GALTISOFF and PERTZOFF (1926), GALTISOFF (1929) and numerous later investigators. CURTIS (1962) concludes from his experiments that: (i) the pattern of separation of cell types in reaggregates of cell mixtures from 2 sponge species is controlled by a mechanism which times different responses in each cell type ('temporal specificity'); (ii) the 'specific adhesion' of cells does not explain the sorting-out process in reaggregation; (iii) there is no evidence for the existence of specific materials cementing cells together.

Mycale Species

Larvae of *Mycale fibrexilis* have been raised by WILSON (1937). Pipetted into dishes (water changed several times a day), the larvae attach firmly within a day or two. WILSON provided cover glasses as substratum or coated the culture dish with a thin layer of paraffin. Cover glasses or small pieces of paraffin were then removed with the larvae attached. Metamorphosed larvae and young spongelets were placed in wire-gauze cages exposed to *in situ* conditions.

Mycale contarenii has been sustained by BOROJEVIC (1966) in sea water with antibiotics (1 million IU of penicillin and 0.25 g streptomycin l⁻¹). BOROJEVIC studied development and cellular differentiation.

Ophlitaspongia seriata

While WILSON (1907) and WARBURTON (1958b) considered the fusion of sponge larvae observed under laboratory conditions to have no, or only restricted,

ecological significance, FRY (1971) suggested that fusion of metamorphosing larvae of *Ophlitaspongia seriata* represents normal behaviour. Compared with single post-larvae of *O. seriata*, fused postlarvae exhibited reduced mortalities. In cultures, metamorphosing larvae from neighbouring *O. seriata* populations—which differ physiologically and morphologically—may fuse and thus provide genotype mixing.

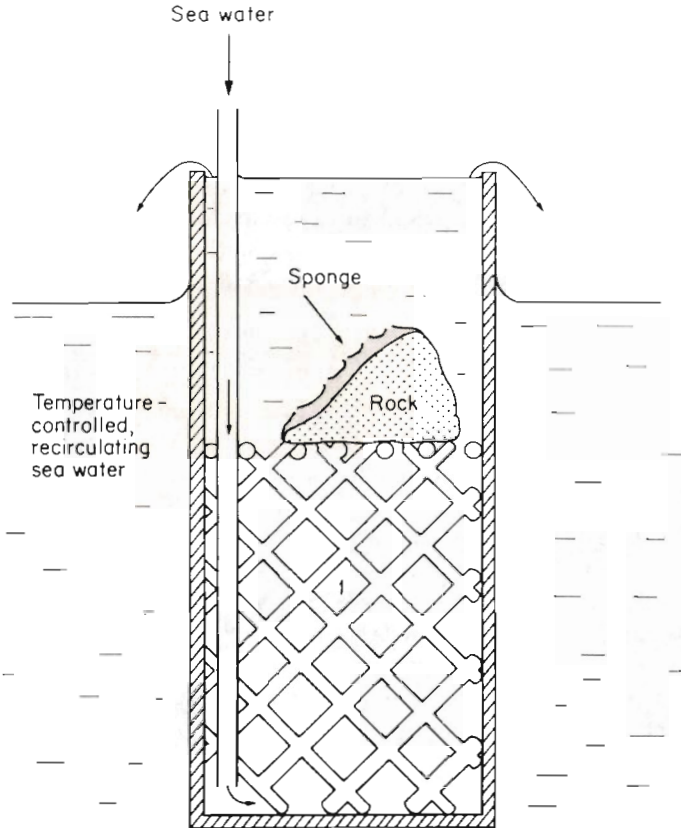

Fig. 5-3: Culture jar for adult *Ophlitaspongia seriata*. The glass-jar surface is painted black, and the jar is partially submerged in recirculating, temperature-controlled sea water. 1: PVC mesh support. (After FRY, 1971; modified; reproduced by permission of Cambridge University Press.)

According to FRY, many sponge 'individuals' represent actually genetically heterogeneous populations of cells.

For long-term cultures, FRY (1971) collected whole individuals of *Ophlitaspongia seriata*, still attached to their rock substratum, and maintained them in jars (Fig. 5-3) kept in the constant environment system described by GRUFFYDD and BAKER (1969). The food supplied to *O. seriata* consisted of *Micromonas squamata* (mean diameter 3.24 μm), *Isochrysis galbana* and *Monochrysis lutheri* (mean diameter 8.85 μm), as well as *Tetraselmis suecica* (mean diameter 6.27 μm). These unicellular algae were mixed in varying proportions depending on the availability of algal

cultures. To each 100 ml of algal suspension were added 100 ml of dead bacterial culture. Presumably, each culture contained primarily species of *Pseudomonas* and *Arthrobacter*. FRY's treatment of bacterial cultures produced numerous very small particles from disrupted bacterial cells, as well as whole dead bacteria. Thus, the total range of potential food-particle sizes encompassed all sizes considered suitable for sponge nutrition (e.g. RASMONT, 1968a).

According to FRY (1971), freshly collected *Ophlitaspongia seriata* began to liberate larvae after slow temperature increase (15° to 18° C in 10 days). Maintained at 18° C, adult sponges received running sea water for 8 out of 24 hrs. During the night and the latter part of the day, every culture jar was covered with a black plastic sheet. The sheet was removed each morning, the sea-water flow stopped for 6 hrs, and 200 ml of food suspension added to each jar. After the water flow had ceased, the sponge's oscular papillae extended, the force of their exhalent currents increased and larvae were ejected. Presumably, diminution of water flow and increase in illumination act as stimuli for larval release. Newly liberated larvae swim rapidly upwards to the water surface with their more pointed end forwards. They rotate about their long axis and follow a looping path within which they gyrate in the same direction as they rotate. Comparable larval locomotion has been described for other sponges and termed 'corkscrew' swimming (WARBURTON, 1966; BERGQUIST and SINCLAIR, 1968; BERGQUIST and co-authors, 1970).

Freshly released larvae of *Ophlitaspongia seriata* were transferred by FRY (1971) into waxed troughs (72 × 40 × 15 mm). Each trough contained a cover glass (72 × 40 mm) which had been washed in fuming nitric acid, thoroughly rinsed in distilled water and oven-dried. The trough was filled with filtered sea water (18° C) containing stock antibiotic solution. During the first day, the larvae were mostly hanging at the air-water interphase. Between 24 and 26 hrs after liberation, about half of the larvae began to metamorphose, and after 34 to 45 hrs, all larvae were in the process of metamorphosis. Less than 5% of the larvae settled and metamorphosed on vertical surfaces.

Sycon Species

In his pioneering experiments, MAAS (1894, 1900, 1904, 1906, 1907, 1910) pipetted larvae of *Sycon* (*Sycandra*) *setosum* and *S. raphanus* into watch glasses or into round glass dishes of 15 to 30 cm diameter and a water height of 3 to 5 cm (dim light; no food; 'constant' temperatures). After larval attachment, MAAS removed the culture water with pipettes and regularly replaced it with new sea water. Early young spongelets formed after about 3 days and grew to 'appreciable size' within 14 days. The young sponges received running, unfiltered sea water from which they obviously obtained their nutrients.

Experimenting with carbonate-free and lime-free sea water, MAAS (1904, 1906) found that metamorphosing larvae and juvenile spongelets of the *Sycon* species studied produced no spicules composed of calcite. Using *Sycon ciliatum* and artificial sea waters in which either the CaCl_2 or the NaHCO_3 had been replaced by NaCl , JONES (1971) corrected some of MAAS's results and established that (i) spicule formation occurred only when the water contained between 0.001 and 0.005 M Ca^{++} and more than 0.001 M HCO_3^- ; (ii) spicules corroded within 4 days in waters

containing either 0.001 M, or less, HCO_3^- , or less than 0.0005 M Ca^{++} ; (iii) spicule production was rapidly restored by returning the spongelets to sea water; (iv) organic spiculoids were not formed. The normal development of *S. ciliatum* is illustrated in Fig. 5-4.

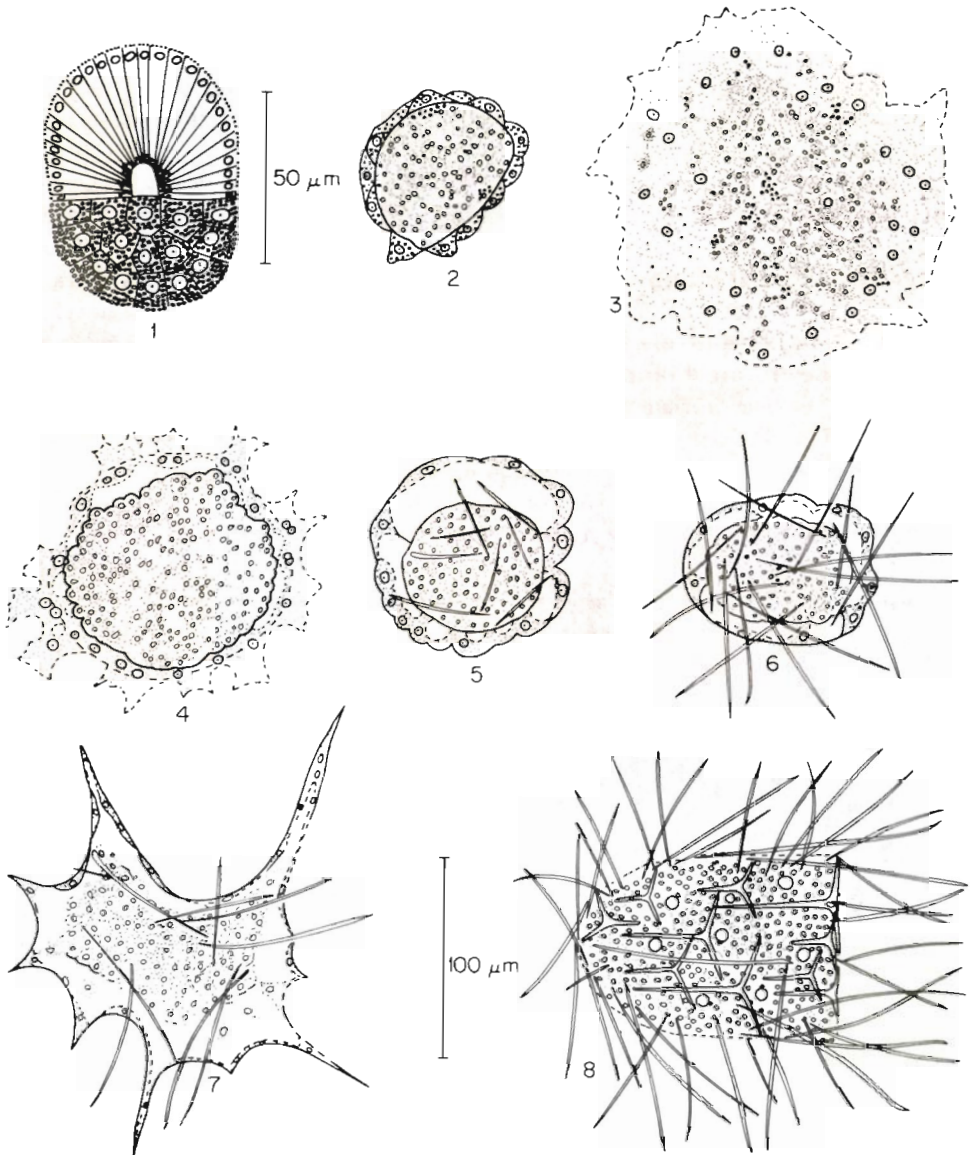

Fig. 5-4: *Sycon ciliatum*. Developmental stages. Note different magnifications for 1 and for 2 to 8, respectively. 1: Amphiblastula; 2: later stage; 3 and 4: pupae; 5: later stage with distinct mesohyl and internal monacts; 6: pre-olyntus; 7: stellate pupa; 8: laterally attached young olynthus with osculum (not visible), choanocytes and pores. (After JONES, 1971; reproduced by permission of Cambridge University Press.)

Table 5-19

Examples of sponges inhabiting public aquaria and related large-volume sea-water systems (After ARNDT, 1933; modified; reproduced by permission of Urban & Schwarzenberg)

Species	Distribution	Locality
Calcarea		
<i>Grantia compressa</i>	Atlantic Ocean	Plymouth
<i>G. lieberkühni</i>	Adriatic Sea	Rovigno
<i>Leucosolenia botryoides</i>	North Sea, Mediterranean, Atlantic Ocean	Helgoland
<i>L. complicata</i>	Baltic Sea, Mediterranean North Sea, Atlantic Ocean, Arctic Ocean	Naples
<i>Sycon capillosum</i> *	Nearly cosmopolitan	Helgoland
<i>S. coronatum</i> *	Nearly cosmopolitan	
<i>S. raphanus</i> *	Nearly cosmopolitan	Naples
<i>S. raphanus</i> var. <i>aquariensis</i> *	Mediterranean	Naples
Tetraxonida		
<i>Chondrosia reniformis</i> *	Mediterranean, Atlantic Ocean, South Sea	Naples
<i>Cliona celata</i>	Nearly cosmopolitan	Helgoland
<i>Ficulina ficus</i>	North Sea, Atlantic Ocean	Helgoland
<i>Geodia gigas</i>	Mediterranean	Rovigno
<i>Suberites domuncula</i>	Mediterranean, Atlantic Ocean	Naples
<i>S. arcicula</i> *	Adriatic Sea	Rovigno
<i>Tethya asseranum</i> *	Mediterranean, Atlantic Ocean	Naples
Cornacuspongida		
' <i>Amorphina</i> sp.'	Mediterranean	Naples
<i>Azinella foveolaria</i>	Mediterranean	Naples
<i>A. polyoides</i> *	Mediterranean	Naples
<i>Chalina oculata</i>	North Sea, Atlantic and Indian Oceans, South Sea	Helgoland
<i>Clathria coralloides</i>	Mediterranean	Rovigno
<i>Euspongia officinalis</i>	Mediterranean, southern parts of the Atlantic, Indian and Pacific Oceans	Naples
<i>Halichondria panicea</i>	Eastern Baltic Sea, North Sea, Atlantic, Indian and Pacific Oceans	Helgoland
<i>Hippospongia equina</i> *	Mediterranean, southern parts of Atlantic, Indian and Pacific Oceans	Naples
<i>Microciona prolifera</i>	East coast North America	New York
<i>Raspailia viminalis</i>	Mediterranean	Rovigno
<i>Reniera alba</i> *	Mediterranean	Rovigno

*These species reproduced in the public aquaria mentioned.

(c) Establishment in Public Aquaria

While it is difficult to sustain Porifera under controlled, definable conditions in laboratory culture experiments (p. 630), many sponges have established themselves in public aquaria or related large-volume sea-water systems (Table 5-19)—providing the running sea water (flow-through or recirculation design) carried sufficient nutrients and oxygen.

The Mediterranean *Clathria coralloides* and *Suberites massa* have tolerated home-fish-aquarium conditions for extended periods of time (GRAEFFE, 1882; ARNDT, 1933).

(d) *In situ* Culture

Towards the end of the 19th century, overfishing of commercially used sponge beds—e.g. in the Mediterranean, near the Bahamas, Cuba or Florida—stimulated investigations into the feasibility of Porifera *in situ* cultivation. Early experiments, especially on members of the genera *Hippospongia* and *Spongia*, concentrated on possibilities for enhancing and controlling sponge growth under habitat conditions. The efforts undertaken have been summarized and evaluated by MOORE (1908b).

A list of *in situ* cultured sponges compiled by JHINGRAN and GOPALAKRISHNAN (1974) comprises Demospongiae of the following representatives: *Euspongia officinalis adriatica*, *E. officinalis lamella*, *E. officinalis mollissima*, *Hipp(i)ospongia canaliculata flabellum*, *H. grossypina*, *H. lachne*, *Spongia agaricina corlosia*, *S. barbara*, *S. dura*, *S. graminea*, *S. obliqua* and *Spongilla* sp. Larvae of commercially used species such as the sheepswool sponge *Hippospongia lachne*, yellow sponge *Spongia barbara*, grass sponge *S. graminea* or the crumb-of-bread sponge *Halicondria panicea* settle on a variety of solid substrates—for example, stones, cement, wood or glass. Pieces cut off from sponge bodies readily regenerate and reattach, as long as they are not too small. Both the attachment of larvae and of cut pieces (cuttings or explants) provide possibilities for the culturist to study *in situ* sponge growth.

HENTSCHEL (1916) allowed sponges to settle on slates (15 × 30 cm; 3 to 4 mm thick) exposed to habitat conditions. ALLEMAND (1906) used cement boxes with wooden spindles as substrate for regenerating cuttings. In later experiments, plastic discs were found suitable for long-term marking of sponges, thus facilitating *in situ* studies on growth patterns or on life span of individuals.

Considering grafting (fusion of cut surfaces of different closely related sponge individuals), growing from eggs or larvae and from reduction bodies or dissociated cells, cuttings, and planting (applying the cuttings to a substrate), MOORE (1908a) concludes that planting of sponge cuttings offers the best possibilities for enhancing *in situ* sponge production. The technique of planting sponge cuttings was introduced by SCHMIDT (1863) and has been improved by ALLEMAND (1906), MOORE (1908a, b) and others. Since wood tends to deteriorate over the years, cement has been preferred as substrate for plantings. Cement discs (Fig. 5-5a, b) or cement triangles (Fig. 5-5c) gave good results. On the cement discs, cuttings (sponge pieces of ca 3.8 × 6.4 × 7.6 cm) are attached by a central lead-wire spindle or by aluminium wire carried through two holes in the disc and twisted on its under side. Smaller cuttings exhibit increased mortalities. On the triangles, 6 leaden spindles (ca 20 cm long) provide support for sponge attachment. This arrangement protects the sponges from

getting buried in sedimenting particles. Sponges such as *Hippospongia lachne* and *Spongia barbara* attached well and firmly to lead-covered materials, and aluminium did not cause any negative effects.

Planted cuttings tend to grow faster than intact sponges. MOORE (1908b) cut a 15-cm diameter *Hippospongia lachne* into 120 pieces. In 4 years, the resulting cuttings totalled a volume about 75 times that of the original sponge (provided there was no mortality). Planted intact, the sponge would increase in the same period only about 4 to 5 times. In contrast to the optimistic view of MOORE, COTTE (1908) warns that cutting and planting involve considerable labour and risks. In his opinion, both methods remain commercially unfeasible as long as naturally growing sponge beds are available and overfishing and destruction can be avoided.

Cut surfaces of closely related sponges will fuse and heal if brought into proper apposition. Each graft continues to grow independently and without exerting recognizable influences on its partner, except in limiting the direction of its growth. However, a cutting from a sponge, grafted on another one which grows in a different environment, tends to approach the other in growth form—due not to the graft but to environmental influences (MOORE, 1908b). This response is identical to that of a sponge transplanted to the same locality without grafting. Experiments on inter-specific grafting have been conducted by LAUBENFELS (1928a).

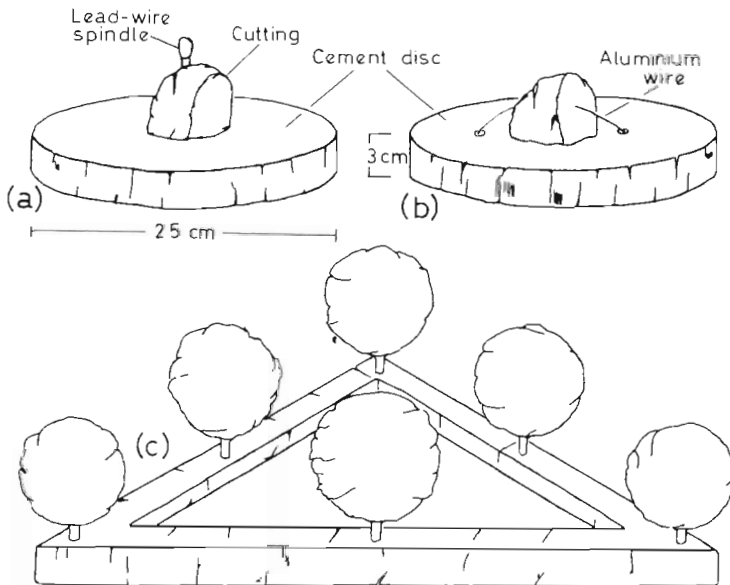

Fig. 5-5: Cement discs and cement triangle with regenerating sponge cuttings. (Based on photographs by MOORE, 1908b.)

(e) Porifera as Assay and Food Organisms

No information is at hand on the role that sponges may play as assay organisms. Considering the difficulty of sustaining marine sponges under controlled, ecologically adequate conditions, most sponges are unlikely to be used as assay organisms

for assessing environmental quality. In general, larvae or tissue cultures seem more promising than adult sponges, at least for short-term experiments.

Molluscs, echinoderms and fishes are known to eat sponges. However, detailed publications on the potential of sponges as food organisms for other cultured organisms are not available.

(f) Porifera: Conclusions

Scientific interest in the cultivation of Porifera has largely been based on the functional and structural uniqueness of this primitive metazoan phylum. Cell differentiation, embryogenesis, regeneration, intercellular dynamics and related aspects have attracted numerous physiologists and morphologists. Very few Porifera have been cultivated with a view to solving ecological problems. Consequently, the role of sponges in marine ecosystems has largely remained in the dark. Tolerance to stress, rates of growth and reproduction as a function of environmental variation, and nutritional requirements of sponges invite the attention of experimental ecologists.

The culture methods employed stress the importance of light, temperature, substrate, water movement and—most of all—nutrition. The most significant problem to be solved in sponge cultivation is the controlled provision of adequate, fine-particulate suspended nutrients. Only a few marine sponges have, thus far, been sustained under laboratory conditions for extended periods of time with acknowledgeable success. Continued reproduction in cultures has remained a rare phenomenon.

Many sponges thrive well in public aquaria and related large-volume sea-water systems. Usually inhabited by a variety of well-fed marine animals, water movement keeps large amounts of minute organic particles in suspension and thus provides nutritional support. The ready establishment of some marine sponges in public aquaria contrasts sharply to their ephemeral existence under controlled experimental conditions. We must still learn how to accommodate sponges under defined environmental and nutritional conditions in small volumes of water. For most sponges, culture methods that would sustain all essential life processes over extended periods of time have still to be worked out.

Early efforts to cultivate sponges were stimulated by commercial interests. As overfishing threatened the most important sponge-fishing grounds in the Mediterranean, the Bahamas, Cuba and Florida, the feasibility of *in situ* sponge cultivation received considerable attention. However, as a variety of synthetic materials became available and increasingly conquered the 'sponge market', interest in enhancing the production of commercially important species decreased rapidly. The review by MOORE (1908b) and a parallel, if less informative, contribution by COTTE (1908) have remained the essential sources for assessing practical methods of economically oriented *in situ* sponge cultivation.

In situ cultivation of sponges is relatively easy. Growth can be enhanced by removal or numerical reduction of predators, transplantation of individuals to suitable 'fattening grounds', and by the planting of cuttings. For diving ecologists, *in situ* experiments on nutrition, growth, reproduction, predation and life cycles

of natural sponge populations promise rewarding results. Much new information can be gained here with limited technical and financial efforts.

(4) Cnidaria

Substrate-attached cnidarians are often easier to cultivate than their planktonic counterparts. Attachment to solid substrata facilitates handling, transfer, growth measurements, feeding experiments, measurements of metabolic performance and assessments of energy budgets. Many asexually reproducing sessile colonial hydroids have been successfully maintained, reared or bred in simple, small culture dishes, containing non-sterilized and non-aerated stagnant sea water. Usually, the sea water (natural or artificial) was renewed at regular (e.g. 1-, 2- or 3-day) intervals. However, some sessile cnidarians require water movement. These forms are kept in moving water, e.g. in flow-through containers (Fig. 2-119, p. 207). Planktonic cnidarians have been sustained in culture both in stagnant and moving water. For medusae, cylindrical vessels are used.

Food specialists are rare among cnidarians. Most forms thrive on a large variety of zooplankters such as rotifers and copepods, as well as on larvae, subadults and adults of numerous invertebrates and fishes. The larvae (planula, actinula) of sessile cnidarians are often able to metamorphose without uptake of external food; this facilitates cultivation and keeps early mortalities lower than in developmental stages of the planktonic phase. The most common food organisms fed to both benthic and planktonic forms are nauplii of *Artemia salina* (p. 743). Some aspects of coelenterate cultivation—predominantly related to growth and feeding—have been covered by LENHOFF and co-authors (1971).

Following WERNER (1973b, 1975) we distinguish here 4 classes of Cnidaria: Scyphozoa, Cubozoa, Hydrozoa and Anthozoa. According to WERNER, the Cubozoa occupy an intermediate position between Scyphozoa (the basal class) and Hydrozoa, while the Anthozoa are considered to represent an early offshoot from the common ancestors.

(a) Scyphozoa

The first review on cultivation of Scyphozoa (and other coelenterates) was presented by HAGMEIER (1933), who summarized the contemporary knowledge on collection, care of scyphistomae, strobilation and raising of ephyrae. Scyphistomae can best be obtained from newly collected medusae carrying planula larvae. A medusa is placed in an aquarium containing adequate substrata for planula attachment (e.g. stones, mollusc shells, microscope slides). After release of a sufficient number of larvae, the medusa is removed. Most planulae settle within 1 or 2 days; some adhere to the water surface from where they can be easily collected. Without taking up food, the planulae metamorphose quickly into small scyphistoma polyps. Together with their substratum, the polyps are transferred to small culture dishes and fed (e.g. plankton; later small pieces of *Enchytraeus albidus*, bivalves or crustaceans) at 1- or 2-day intervals as soon as the tentacles appear (weak aeration or slowly running water, avoidance of high illumination).

Well-fed scyphistomae usually grow rapidly and tend to cover the walls of the culture containers in dense 'lawns'. Scyphistoma lawns may also thrive in aquaria tanks containing regularly fed fishes, where the scyphistomae catch and consume small food remains drifting in the water.

Aurelia aurita

As in other scyphozoans, ephyrae of *Aurelia aurita* have been either collected at sea or—more often—obtained from cultured strobilating scyphistomae. Freshly strobilated ephyrae are accommodated in round culture enclosures of 5- to 10-l capacity containing non-aerated or weakly-aerated sea water (same temperature as in strobilation tank). According to HAGMEIER (1933), the ephyrae thrive between 5° and 10° C, stop feeding at about 3° C and die near -2° C. HAGMEIER grew *A. aurita* medusae to sexual maturity in a round 60-l culture enclosure containing 2 individuals. The medusae were transferred (glass tube, spoon, beaker; but not with a net) to clean containers with fresh sea water of comparable quality and identical temperature at intervals of 1, 2 or 3 days. Young ephyrae are best fed individually and regularly (at least once, better twice, a day). Several-week-old ephyrae can get along for a day or two without food, but soon begin to show regression and abnormal development unless a suitable feeding schedule is restored (see also DE BEER and HUXLEY, 1924). DELAP (1907) fed small ephyrae of *A. aurita* small *Obelia* sp. medusae; larger ephyrae and small medusae seem to prefer eggs and larvae of fishes; rapid growth of 12-week-old specimens was obtained on *Clione* sp. and on *Limacina* sp. Pieces of *Sagitta* sp. or of fresh *Mytilus edulis*, or meat of shrimp and other crustaceans, are readily accepted. HAGMEIER found copepods to be unsuitable as food for the earliest ephyra stages. He offered living plankton, including copepods, only to medusae of 4 weeks or older.

SPANGENBERG (1965) raised and bred *Aurelia aurita* in artificial sea water. The scyphistomae were kept in culture dishes containing approximately 600 cm³ of water. Polyps were fed twice weekly for 24 hrs with freshly hatched nauplii of *Artemia salina* and transferred to new dishes with clean sea water after each feeding. Some cultures were kept at 21° to 24° C, but most at 27° C. The scyphistomae grew and strobilated in the same way and intensity as parallel series kept in natural sea water. In some of the cultures, strobilation occurred continually (SPANGENBERG, 1964).

Ephyrae, obtained from cultivated, strobilating scyphistomae, were raised (SPANGENBERG, 1965) in aerated artificial sea water. Three ephyrae were allowed about 2 l of water, and fed *A. salina* larvae daily. SPANGENBERG selected ephyrae developing early during strobilation of well-fed scyphistomae; these ephyrae are usually larger and better able to catch and take up brine shrimp larvae than those developing later. For a review on strobilation in jellyfish consult SPANGENBERG (1968).

Young medusae of *Aurelia aurita* were raised by SPANGENBERG (1965) in 20-l jars (at least about 4 l of sea water per medusa). After 6 weeks to 2 months, the medusae were transferred to tall cylindrical chromatography jars containing 40 l of artificial sea water (21°–24° C). According to SPANGENBERG, continued aeration is essential to the medusae: developing medusae tend to disintegrate if aeration

stops. Medusae that showed signs of deterioration (involution of bell; loss of mouth arms) were transferred immediately to clean artificial sea water. However, *A. aurita* medusae have also been raised successfully in daily renewed natural sea water (15° C; 2 to 3 individuals 40 l⁻¹) without aeration (KINNE, unpublished). The average number of days required for attaining developmental stages II to IX is listed in Table 5-20. There was considerable variation in size of medusae both within a group and between groups. Males attained sexual maturity at 112 days in Group 1; 121 days in Group 2; 39 days in Group 5; 38 days in Group 8. F₂-planulae were found after 153 days in Group 1; 88 days in Group 5.

Table 5-20

Aurelia aurita. Development (time in days) of medusae in artificial sea water (specific gravity: 1.025; 21° to 24° C; pH: 7.8). *n* = number of individuals. Size and age of the most rapidly developing medusae were recorded upon reaching a new development stage (After SPANGENBERG, 1965; modified; reproduced by permission of The Wistar Institute of Anatomy and Biology)

Stage	Diameter of bell (mm)	Group number							
		1 (<i>n</i> = 6)	2 (<i>n</i> = 2)	3 (<i>n</i> = 8)	4 (<i>n</i> = 8)	5 (<i>n</i> = 16)	6 (<i>n</i> = 20)	7 (<i>n</i> = 16)	8 (<i>n</i> = 20)
II	6-8	5	6	7	6	7	16	14	12
III	6-20	11	11	13	10	10	20	21	15
IV	8-23	30	15	20		18	37	31	22
V	15-25	38	20	24			49	33	27
VI	13-32	61	50	28	30			49	29
VII	16-28	66		36		25	65	56	34
VIII	17-35	75	70	52	34	31	79	70	48
IX	30-50	105	80	60	42	45			

Cephea cephea

Cephea cephea, a tropical rhizostome, has been cultured under conditions similar to those reported for *Mastigias papua* (see below) (SUGIURA, 1966). However, the culture-dish bottom was covered by agar gel (substrate for planula attachment). Young scyphistomae received *Artemia salina* nauplii as food and were kept under continuous illumination (no details) at 20° C. The scyphistomae budded readily under these conditions. Strobilation could be induced by increasing the temperature ('several degrees centigrade').

Ephyrae were raised to medusae (up to 45 mm umbrella diameter) in aquaria (50 × 30 × 10 cm high). They received a rich daily supply of *Artemia salina* nauplii and were kept under continuous fluorescent light at 28° C.

Chrysaora quinquecirrha

In the sea nettle *Chrysaora quinquecirrha*, strobilation has been studied by CONES (1969). Polyps were obtained from oyster shells dredged in January (3° to

5° C; 12 to 15‰S). The shells were cleaned and placed in a 20-l Plexiglas aquarium (running sea water during the day; shut off at night to facilitate feeding the polyps with nauplii of *Artemia salina*). After slow temperature increase (to 20° C within 12 days), strobilation started and continued over about 2 weeks. Strobilation ceased when the temperature was decreased suddenly to 3° to 5° C; thereafter, the polyps gradually assumed the overwintering form. It was possible to reinduce strobilation in the same polyps by the thermal treatment outlined.

The process of strobilation in *Chrysaora quinquecirrha* has been described by CONES (1969) in some detail. Just prior to strobilation, the goblet-shaped polyp undergoes colour change (from white to pale pink and then to red or crimson) and clefting. Typically, each scyphistoma releases 5 ephyrae. All terminal tentacles are resorbed during strobilation. Newly released ephyrae swim to the surface. Strobilation is completed 20 to 25 hrs after clefting. All stages survive well on *A. salina* larvae, enchytraeids, ground ctenophores and similar food.

Mastigias papua

In *Mastigias papua*, SUGIURA (1963) induced strobilation by introducing zooxanthellae into the scyphistomae as symbionts. In the bays of Aburatsubo, Moroiso and Koajiro (Japan), adult medusae of *M. papua* occur from summer to autumn and measure 8 to 20 cm in diameter. SUGIURA studied the development of *M. papua* from planula to ephyra. Planulae were separated from adults, washed with filtered, sterilized sea water and placed in culture dishes of 9 cm diameter filled 1 cm high with sea water. When some planulae had attached themselves to the dish, all remaining planulae were removed and *Artemia salina* larvae offered as food for the developing scyphistomae. The sea water was renewed after feeding, at about weekly intervals.

Rhopilema verrilli

Isolated from a recently collected medusa, planulae of *Rhopilema verrilli* were transferred to covered preparation dishes containing about 200 ml filtered sea water of 16‰S (CALDER, 1973). Scyphistomae received nauplii of *Artemia salina* as food, at least once a week. After feeding, dead brine shrimp larvae were removed with a Pasteur pipette. Initially, scyphistoma cultures were kept at 10° to 12° C; after 4 months they were transferred to an unlighted 20° C incubator. Within 5 weeks, strobilae occurred. After liberation, ephyrae were fed brine shrimp nauplii and placed in plastic containers filled with 900 ml sea water (identical to that used for polyp cultures). Each culture enclosure was agitated gently on an Eberbach table-top shaker. Developing ephyrae and medusae received brine shrimp larvae once or twice daily; the water was changed every 48 hrs.

The planulae of *Rhopilema verrilli* began to set and to develop into scyphistomae within 7 to 10 days after collection from the gonad of the parent medusa (Fig. 5-6). Scyphistomae grew rather slowly at 10° to 12° C, but rapidly at 20° C (no details given). Although strobilation was typically monodiscous, occasionally 2 ephyrae were formed per strobila (in one case 3). Complete strobilation of an ephyra lasted about 7 days. Newly liberated ephyrae (Fig. 5-7) are sluggish in their movements;

they have 8 pairs of lappets and 8 rhopalia. Most remained on the bottom of the culture container with the lappets curled down towards or over the manubrium. The development of the ephyrae resembles that in the closely related *Rhizostoma pulmo* (RUSSELL, 1970). The only means of asexual reproduction observed by CALDER (1973) involved podocyst formation.

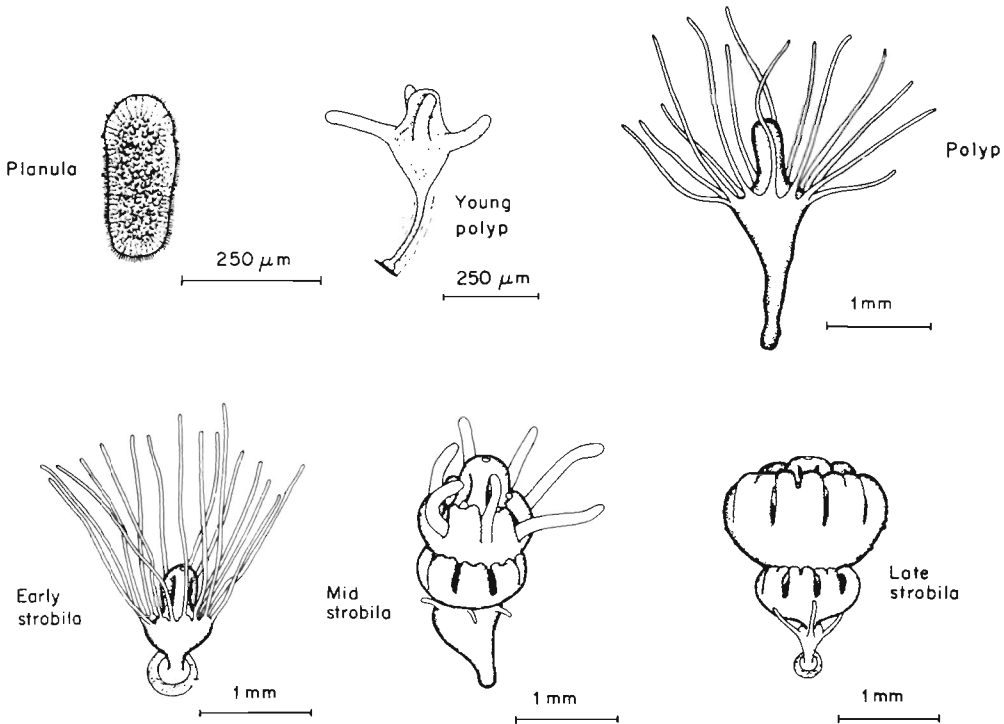

Fig. 5-6: *Rhopilema verrilli*. Development from planula to late strobila. (After CALDER, 1973; reproduced by permission of Springer-Verlag.)

Stephanoscyphus planulophorus

A solitary coronate with a unique development, *Stephanoscyphus planulophorus* inhabits submarine caves, attaching itself to coral colonies (WERNER, 1971). The free-swimming medusa generation is completely reduced. During strobilation, numerous ephyra-like stages form in the polyp tube (Fig. 5-8). The ephyrae metamorphose directly to flagellated free-swimming planulae. Following a long incubation period, the planulae hatch and remain planktonic for about 20 to 50 days (20° to 22° C; 34‰S). Each then settles and develops into a polyp with a basic disc and a small peridermal tube (reduced metagenesis). Sexual reproduction has never been observed.

The culture conditions employed were comparable to those described earlier (WERNER, 1968, see p. 652) with one important addition: the harpacticoid copepod *Tisbe holothuriae* (syn: *T. helgolandica*) (p. 765) was introduced (in 'sufficient numbers') as culture partner. *T. holothuriae* serves two functions: (i) it keeps the

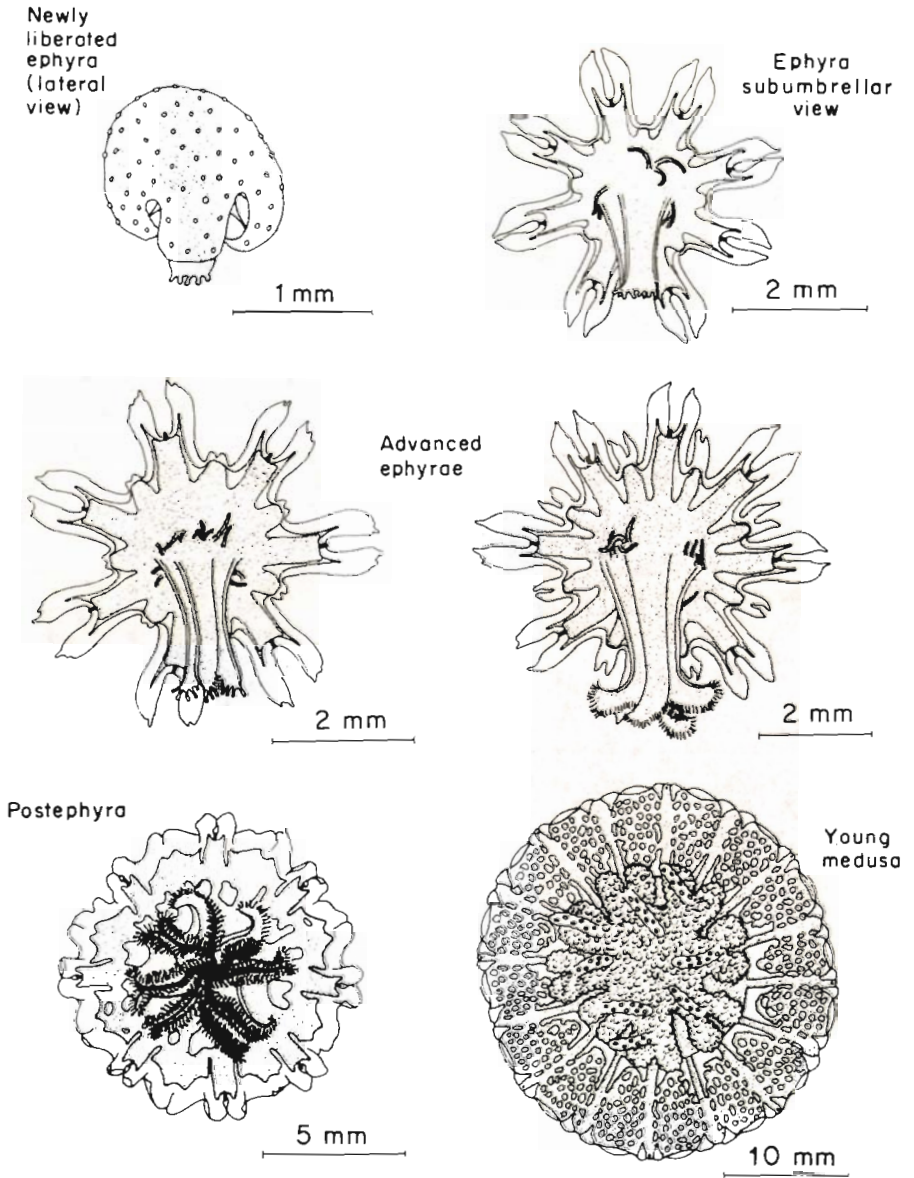

Fig. 5-7: *Rhopilema verrilli*. Development from newly liberated ephyra to young medusa. (After CALDER, 1973; reproduced by permission of Springer-Verlag.)

polyp colonies clean, i.e. it consumes food remains, etc.; (ii) it serves as additional food source (at 15° C, one feeding per week is sufficient for supporting good polyp growth). Nauplii of *T. holothuriae* can be consumed even by small polyps. Adequately sized food for small polyps was also obtained by squeezing the hepatopancreas of *Mytilus edulis* (forceps) and by transferring (fine-drawn glass needles, micropipettes) the gland contents on the stretched-out tentacles or on the oral

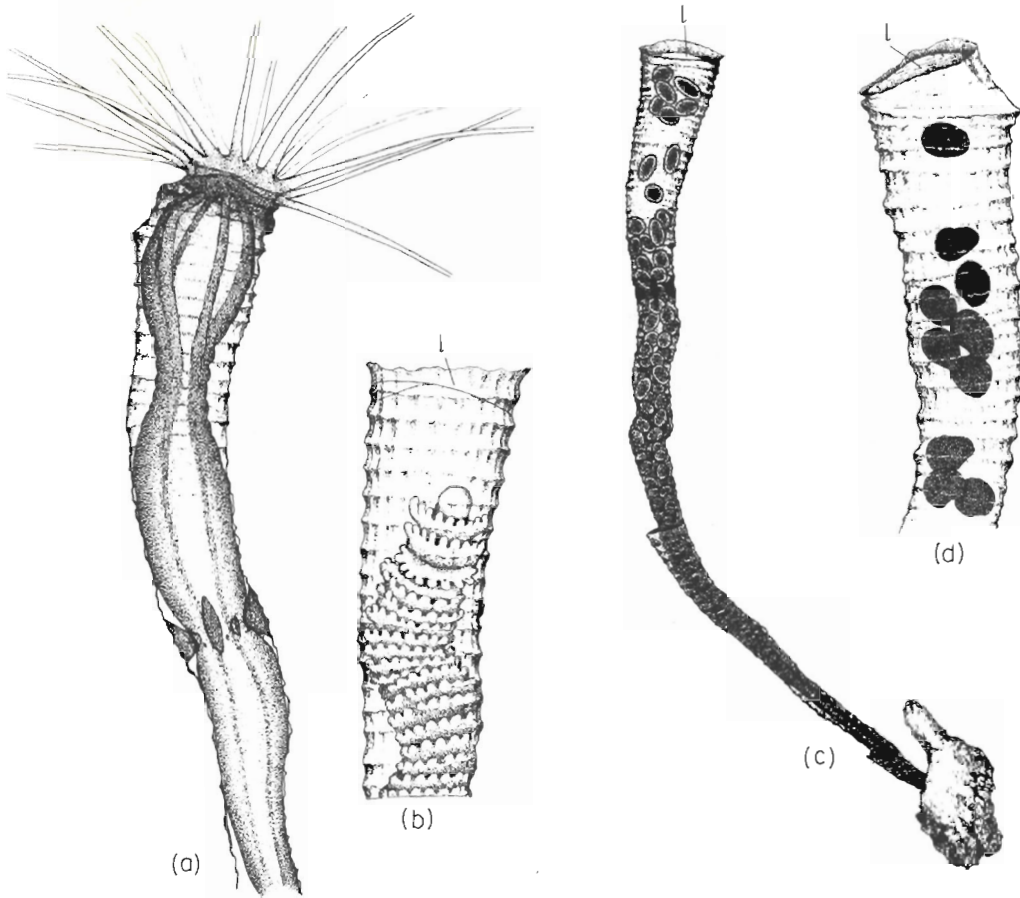

Fig. 5-8: *Stephanoscyphus planulophorus*. Polyp at beginning (a) and advanced strobilation (b); with disc-shaped ephyrae in advanced stage of transformation into planulae (c); with ellipsoid ciliated planulae swimming busily in the polyp tube (d). Planulae leave the polyp tube after 20 to 50 days, penetrating the periderm lid (l). (a, c, d after WERNER, 1971; b after WERNER, 1973b; reproduced by permission of Biologische Anstalt Helgoland.)

disc of the youngest polyp stages (see also WERNER, 1966, 1967, 1968, 1970a, b, 1974, 1975).

Other Species

Cultivation techniques principally similar to those used for *Aurelia aurita* (p. 642) have been employed also for other Scyphozoa:

(i) *Cyanea capillata* (HINRICHS in: HAGMEIER, 1933). Food for ephyrae: flesh of *Mytilus edulis*, ovarium of *Carcinus maenas*, small hydromedusae. Medusae of >20 mm diameter consumed *Bolina* sp. and *Eutonina* sp.; they did not thrive without hydromedusae.

(ii) *Cyanea lamarckii* (DELAP, 1905). Food for ephyrae: freshly caught plankton, copepods and very small hydromedusae (e.g. newly separated *Sarsia* sp.), fish eggs. Older medusae fed on hydromedusae and ctenophorans; *Tiara pileata* and *Beroë ovata* were not accepted.

(iii) *Chrysaora hysoscella* (DELAP, 1901; HINRICHS, unpublished). Food for polyps: plankton such as small *Sarsia* sp. or copepods; for ephyrae: flesh of *Mytilus edulis*, ovarium of *Carcinus maenas*, small hydromedusae such as *Lizzia* sp. or *Sarsia* sp. Absolute requirement for medusae: hydromedusae and ctenophorans; *Tiara pileata* and *Beroë ovata*, crustaceans and fish larvae were not eaten.

Additional papers involving cultivation of scyphozoans have been published by HARGITT and HARGITT (1910), PEREZ (1920) and LITTLEFORD (1939) who studied *Dactylometra quinquecirrha*.

(b) Cubozoa

Commonly called 'box jellies' because of their shape, or 'sea wasps' because of the severe sting of some of their members, the Cubomedusae inhabit neritic zones of tropical ocean areas. Though known for more than 200 years, their life cycles have remained in the dark until quite recently. CONANT (1898) raised the planula of *Tripedalia cystophora* to the four-tentacled polyp, and OKADA (1927) raised *Carybdea rastoni* to about the same stage. But in neither case did the polyps live to an age which revealed their unusual nature. Derived from knowledge on the medusa generation alone, it was originally assumed that the Cubomedusae represent an aberrant order of the Scyphozoa. Only after cultivating *T. cystophora* throughout its whole life cycle, could WERNER and co-authors (1971) and WERNER (1973a, b, 1975) correct this view.

Employing the culture methods outlined by WERNER (1968; p. 652), WERNER and co-authors (1971) discovered important life-cycle details (Fig. 5-9). The fertilized eggs of *Tripedalia cystophora* develop into planulae in the gastral pockets of the larviparous female medusa. Released planulae are slightly pyriform and have a diameter of 0.13 mm. Settling within 2 days, the planulae exhibit a preference for darkness and for bivalve shells; they also accept glass or plastic as substratum. A polyp with mouth and 4 tentacles forms after 2 to 3 days. Although naked at first, the polyp's base is enveloped by a thin transparent periderm upon attaining the 4-tentacle stage. As soon as they begin to feed, the polyps grow rapidly. With 5 or 6 tentacles (body length: 0.5 mm) the polyps begin to produce asexual buds from their basal body wall which acquire a functional mouth and tentacles before release. On detachment, the 2- or 4-tentacled bud (secondary polyp) elongates; it glides—crown first—over the substratum with the help of one tentacle which has grown longer than the others. The secondary polyp soon attaches, becomes pyriform, and develops a peridermal sheath about its base. It buds more polyps in the same manner as the first (primary) polyp. At an age of 8 to 10 weeks, primary and secondary polyps carry a single whorl of 7 to 9 tentacles, have body length of 0.8 to 1.0 mm and appear to be fully grown. The chief features of the solitary polyp are its long, contractile, cone-shaped peristome and its completely retractile, capitate solid tentacles which bear nematocysts only at their tips. Scyphopolyp features (cruciform-shaped mouth, peristomal pits, gastric septa and pockets,

septal funnels and muscles, thick mesogloea) are absent. A tetra-radial symmetry appears only during transformation to the medusa. Hence, the *T. cystophora* polyp more closely resembles a hydro-polyp than a scyphopolyp. Several features distinguish it from both a hydro-polyp and a scyphopolyp. The polyp is further unique in that it metamorphoses into a single medusa.

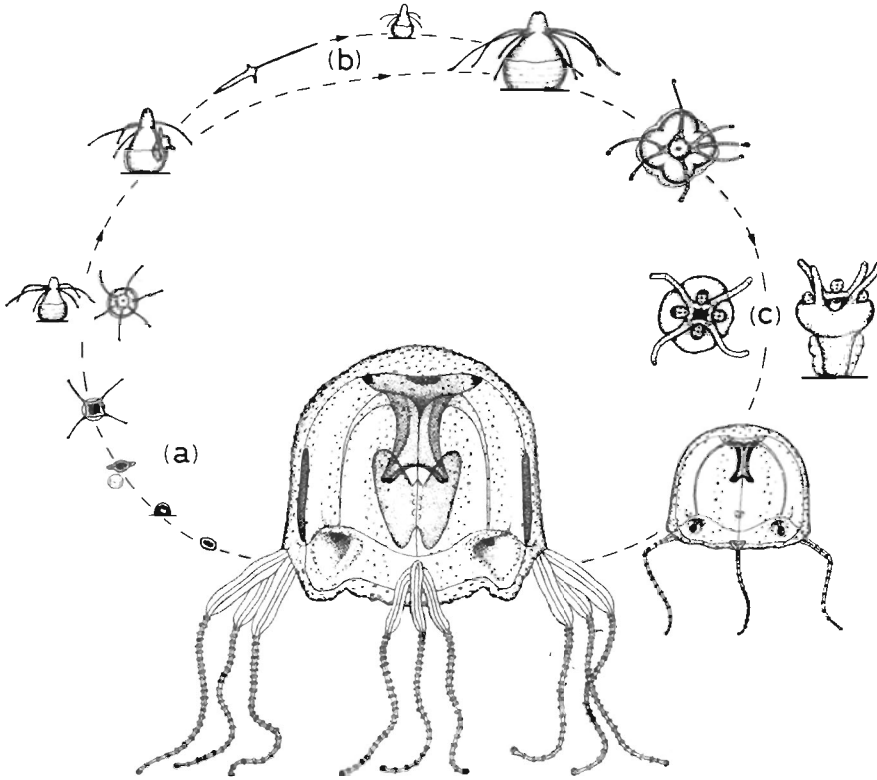

Fig. 5-9: *Tripedalia cystophora*. Complete life cycle obtained in culture. (a) Development of planula into a young sessile primary polyp; (b) asexual reproduction by lateral budding (secondary polyp; (c) metamorphosis of fully grown polyp into a single medusa. (After WERNER, 1973b; reproduced by permission of Seto Marine Biological Laboratory.)

The pulsating medusa of *Tripedalia cystophora* detaches from within the peridermal cup and swims away. Newly liberated medusae have a bell diameter of 1.0 to 3.0 mm and 4 primary tentacles that lack pedalia (WERNER and co-authors, 1971). Several reproductive features of *T. cystophora* are new for Cnidaria medusae (WERNER, 1973a): In the gonads of ripe male medusae, numerous spermatozoa are joined to form simple spermatozeugmata. Numerous spermatozeugmata join to big globular bodies (spermatophores), which develop in small grooves on the stomach's inside surface. The spermatophores are transferred directly from the male to the female medusa.

(c) Hydrozoa

The earliest cultivation experiments on hydrozoans have been performed by HARTLAUB (1884, 1895, 1896, 1897) and BROWNE (1907). Following these pioneers, and building on the fundament provided by them, a large number of hydroids have been maintained, raised or bred under laboratory conditions (Table 5-21). In sessile colonial hydroids, attachment to a solid substratum, asexual reproduction and high capacities for regeneration tend to facilitate cultivation.

HARTLAUB (1897) found it easier to achieve sexual reproduction in hydroid colonies when collected in a sexually mature state, than when raised from planulae. This fact suggests inadequate support (environmental conditions, food) under the culture conditions provided. Unfortunately, most of HARTLAUB's observations have never been published; some have been included in HAGMEIER's (1933) review which has served as source for the following information. HARTLAUB obtained fertilized hydrozoan eggs from carefully collected, sexually mature medusae transferred into glass dishes of sufficient size. Most newly caught medusae survived for some time in stagnant sea water, providing extensive temperature changes were avoided. Swarming planulae were transferred to separate culture enclosures where they attached themselves to the glass walls or other provided substrata within hours or a few days; the young polyps were fed first with natural nannoplankton, later with unselected plankton. In a manuscript, HARTLAUB mentions the now well-established fact that many hydrozoan colonies (e.g. *Halecium halecinum*) lose their polyp 'heads' as soon as environmental conditions change (e.g. water quality, temperature, nutrition), but that hydranths tend to reappear somewhat later providing the environmental conditions have stabilized and are suitable. A colony of *Sarsia decipiens* has been cultured by HARTLAUB (1916) for several years in an open-system aquarium (50 × 40 × 45 cm) with luxurious algal growth, placed in a 'bright corner' of a culture room. Freshly caught copepods served as food and were directed towards the colony by a natural light gradient (phototaxis).

BROWNE (1907) maintained and raised *Syncoryne eximia* and *Bougainvillia muscus*. For *S. eximia* he obtained high growth rates (up to 7.0 mm day⁻¹; exact temperature not known). However, most colonies regressed after several days and disintegrated. BROWNE designed two devices for culturing hydroids: a recirculation tube (Fig. 2-119, p. 207) for growing substratum-attached hydroid colonies, and the plunger jar (Fig. 2-111, p. 200) for accommodating planktonic forms.

Early *in situ* culture experiments on hydroid polyps have been performed by VON REITZENSTEIN and EICHELBAUM (1913) and ORTON (1914). The former authors conducted growth studies in anchored culture boxes (100 × 60 × 80 cm; with numerous holes of ca. 3 cm diameter) floating about 50 m above the North Sea bottom. Each box contained about 30 colonies of *Sertularia cupressina* or *Hydrallmania falcata*. The colonies, marked with aluminium numbers, survived only in coastal areas with low sedimentation rates. ORTON allowed species of *Obelia*, *Plumularia* and *Gomothyrea*, as well as *Clytia johnstoni*, *Bougainvillia ramosa* and *Tubularia larynx*, to settle on artificial substrata and studied their life cycles under natural conditions.

Most of the subsequent contributions devoted to Hydrozoa cultivation are briefly reviewed below or listed in Table 5-21.

Table 5-21

List of colonial hydroids raised, reared or bred under laboratory conditions (After DAVIS, 1971; modified and extended; reproduced by permission of University of Hawaii Press, Honolulu)

Group, genus species	Author
Thecaphorae-Leptomedusae	
<i>Aequorea coerulescens</i>	KAKINUMA (1966b)
<i>Campanularia calceolifera</i>	MILLER (1966)
<i>C. flexuosa</i>	CROWELL (1953)
<i>C. johnstoni</i>	WEILER-STOLT (1960)
<i>Clytia attenuata</i>	WEST and RENSHAW (1970)
<i>C. johnstoni</i>	HALE (1960), BROCK and STREHLER (1963)
<i>Eirene viridula</i>	WERNER (1968), KARBE (1972), BIERBACH and HOFMANN (1973)
<i>Eucheilota maculata</i>	WERNER (1968)
<i>Lovenella (=Eucheilota) clausa</i>	RUSSELL (1936)
<i>Mitrocomella (=Cuspidella) brownei</i>	REES and RUSSELL (1937)
<i>Obelia</i> sp.	PALINGSAR and PALINGSAR (1960)
Athecatae-Anthomedusae	
<i>Acaulis ilonae</i>	BRINCKMANN-VOSS (1966)
<i>Amphinema dinema</i>	REES and RUSSELL (1937)
<i>A. rugosum</i>	REES and RUSSELL (1937)
<i>Bougainvillia carolinensis</i>	BROCK and STREHLER (1963)
<i>B. muscus</i>	BROWNE (1907)
<i>B.</i> sp.	TUSOV and DAVIS (1971)
<i>Cladonema radiatum</i>	WEILER-STOLT (1960)
<i>Clava multicornis</i>	KINNE and PAFFENHÖFER (1965)
<i>C. squamata</i>	FØYN (1927a, b)
<i>Cordylophora caspia</i>	ROCH (1924), KINNE (1956), CROWELL (1957), FULTON (1960), ARNDT and FÄLBER (1971)
<i>Coryne tubulosa</i>	REES (1941)
<i>Dipurena halterata</i>	REES (1939)
<i>D. reesi</i>	GÜNZL (1959, 1964)
<i>Eleutheria dichotoma</i>	WEILER-STOLT (1960)
<i>Eudendrium armatum</i>	WASSERTHAL (1973)
<i>Hydractinia echinata</i>	HAUENSCHILD and KANELIS (1953), MÜLLER (1961a, b, 1964, 1973), TOTTH (1965)
<i>Margelopsis haeckeli</i>	WERNER (1955a, b, 1968)
<i>Merga galleri</i>	BRINCKMANN (1962)
<i>Nemopsis dofteini</i>	NAGAO (1964)
<i>Podocoryne carnea</i>	BRAVERMAN (1962)
<i>P. hartlaubi</i>	YAMADA (1961)
<i>Protohydra leuckarti</i>	MUUS (1966)
<i>Rathkea octopunctata</i>	REES and RUSSELL (1937), WERNER (1958, 1968)
<i>Rhizorhagium album</i>	REES (1938)
<i>Sarsia tubulosa</i>	KAKINUMA (1966a)
<i>Stauridiosarsia japonica</i>	NAGAO (1962)
<i>S. producta</i>	HARTLAUB (1895)
<i>Staurocladia portmanni</i>	BRINCKMANN (1964)

Table 5-21—Continued

Group, genus species	Author
<i>Staurocoryne filiformis</i>	REES (1936)
<i>Syncoryne eximia</i>	BROWNE (1907)
<i>Tubularia crocea</i>	MACKIE (1966), WEST and RENSHAW (1970)
<i>Zanclaea implexa</i>	RUSSELL and REES (1936)
Trachylina	
<i>Craspedacusta sowerbyi</i>	REISINGER (1957), McCLARY (1959), LYTLE (1961), MATTHEWS (1966)

The papers listed describe the culture methods used for each species. Accounts in which established methods were employed are not included unless they were used to culture a different species. When more than one reference is listed for a species, each reference describes a different methodological aspect.

Additional papers involving cultivation of hydroids have been published by BERRILL (1949c, 1950, 1953a, b, 1961), HAMMETT (1950), CROWELL (1953), HANCOCK and co-authors (1956), CHAPMAN (1957, 1961), CROWELL and WYTENBACH (1957), HAND and JONES (1957), BRAVERMAN (1963), FULTON (1963a, b), HALE (1964, 1973), CROWELL and co-authors (1965), HUDSON (1965), BRAVERMAN and SCHRANDT (1966, 1969), CAMPBELL (1966, 1968a, b) and WYTENBACH (1969).

Attempts by the reviewer to tabulate data on rates of survival, growth and reproduction, as well as on food and culture conditions, failed. The pertinent information provided in most of the papers is insufficient to make such a table meaningful. Growth rates obtained in cultured colonial hydroids have been tabulated by DAVIS (1971); but of the 11 species listed, temperature conditions are given for only 2 and in no case have the food sources been mentioned nor other important culture conditions which are known to determine metabolic performance. What good is such a table? Future investigators should carefully record and state important parameters of their culture conditions (e.g. light, temperature, salinity, oxygen and carbon dioxide levels, diet) and provide sufficient information on the material used and the measurements made.

General Methods

General methods employed for cultivating hydrozoans have been summarized by WERNER (1968), who cultured, for example, *Rathkea octopunctata*, *Eucheilota maculata* and *Margelopsis haeckeli* (WERNER, 1955a, b, 1956, 1958). WERNER always used natural sea water transported in large glass bottles and stored in darkness. Prior to use in cultivation, the sea water was Seitz filtered. The filters retained particulate substances and reduced the number of micro-organisms. WERNER employed agnotobiotic stagnant-water cultures in small glass dishes (diameter about 10 cm, height up to 5 cm), filled to 4/5 with culture water, covered with a glass lid. Except for feeding and control, the cultures were usually kept in darkness. Larvae of *Artemia salina* were used as main food source. Since freshly hatched nauplii contain large amounts of energy-rich reserve substances (which

may cause symptoms of over-feeding, abnormal development, or death; see also HAUENSCHILD, 1954, 1956a), WERNER allows them to use up part of these substances before feeding them to the cnidarians. At temperatures exceeding 22° C, a period of 3 to 4 days after hatching of the nauplii is sufficient for this purpose. Upon metabolizing a significant portion of the reserve substances, the larvae become increasingly transparent.

If early medusa stages or primary polyps are too small to handle a whole nauplius of *Artemia salina*, they are hand-fed nauplius pieces until large enough to swallow a nauplius *in toto*. Later, the nauplii may be immobilized (rapid passage through narrow pipette) prior to feeding in order to assist the young cnidarians to overcome their prey. Before feeding established cultures, WERNER (1968) removes some of the culture water. He then adds a large number of nauplii. After about 1 hr, the medusae have completely filled their stomachs and are now transferred into a dish with fresh culture water. Polyps attached to the bottom of the dish or to a microscope slide must be carefully but rigorously cleaned (rinsing with pipette) and then also accommodated in fresh culture water. For further details concerning feeding of cnidarians with *A. salina* larvae consult p. 755.

Some hydrozoans thrive best on a more balanced diet for maximum growth and reproduction, for example, rotifers, copepods, invertebrate and fish larvae, as well as small pieces of highly nutritious animal tissues, such as mollusc hepatopancreas. A few representatives exhibit nutritional preferences, e.g. *Gonionemus vertens* for isopods and amphipods.

Feeding intervals depend on environmental factors and cultivation goal. In general, warm-water forms (requiring temperatures in excess of 20° C) should be fed at intervals of 1 or 2 days, while for cold-water forms (2° to 15° C) feeding once or twice a week is usually sufficient. According to WERNER (1968), thecate hydroids frequently exhibit higher metabolic rates than atehcate hydroids and, hence, tend to require more food at shorter feeding intervals. Polyps of arctic-boreal forms often thrive best (vegetatively) at temperatures between 5° and 10° C; of boreo-arctic and boreal forms, between 10° and 15° C; of Mediterranean-boreal forms, between 18° and 20° C; and of tropical forms, between 22° and 24° C. Initiation of sexual reproduction (gonophore formation) frequently requires a change in temperature (WERNER, 1955a, b, 1956, 1958, 1961, 1963). In metagenetic forms, temperature requirements for sexual reproduction may be deduced from the seasonal appearance of medusae in the plankton.

WERNER's simple cultivation techniques have proved very successful. He has kept in continuous culture polyps of *Margelopsis haeckeli* and of *Eucheilota maculata* for 10 years, of *Rathkea octopunctata* for 12 years, and of *Gonionemus vertens* for 19 years. During these long periods it has been possible to regularly induce sexual reproduction (WERNER, 1968).

Hydroid Medusae

Early reports on keeping hydroid medusae alive in an aquarium have been presented by HARTLAUB (1897) and BROWNE (1898). HARTLAUB used mostly round glasses with daily changed stagnant sea water and fed the youngest medusa stages individually with small pieces of chaetognaths or copepods. Within 4 weeks,

he raised freshly separated *Stauridiosarsia producta* (syn.: *Stauridium productum*) of hardly 1 mm diameter to sexual maturity. *Leuckartiara octona* did not accept copepods; its earliest stages received mainly *Sagitta* sp. Other hydroid medusae raised to maturity by HARTLAUB are: *Phialidium variable* and species of *Sarsia* and *Bougainvillia* (all in culture glasses with a plunger jar; see below).

Olindias sp. has been raised on pieces of *Tubifex* sp. (SCHLEGELMILCH in: HAGMEIER, 1933). BROWNE (1898) considers water movement essential for cultured medusae. He developed the plunger-jar technique: a glass plate is moved up and down 'fairly slowly' inside the culture jar (Fig. 2-111, p. 200). BROWNE'S bell jar contained about 46 l of sea water. Temperatures varied from 14.8° to 17.5° C, and were kept down on hot days by placing round the jar 'a strip of flannel, upon which played a jet of fresh water' (BROWNE, 1898, p. 178). Freshly collected marine copepods served as food source. BROWNE maintained hydroid medusae (species of *Obelia*, *Phialidium*, *Lar*, *Margelis*, *Sarsia* and *Perigonimus*) for up to several weeks. An account on jellyfish life cycles has been presented by LAMBERT (1935).

Medusae of *Eutima sapinhoa* have been raised from polyps living on the bivalve *Tivela mactroides* by NARCHI and HEBLING (1975). The polyps were kept in dishes containing 200 ml filtered sea water (20° to 22° C, 35‰S). Newly liberated medusae were transferred to 900-ml containers. Both medusae and polyp received nauplii of *Artemia salina* as food. The culture water was exchanged once or twice daily.

Bougainvillia sp.

Bougainvillia sp., isolated from material collected in Kaneohe Bay, Oahu, USA, has been raised, reared and bred by TUSOV and DAVIS (1971), who determined growth rates under the influence of different environmental factors. Only a few colonies produced gonophores and medusae; they were not fed regularly and the culture medium was not changed frequently. Gonophores did not develop under standard conditions (substrate: microscope slides, slanted in 100-ml beakers; medium: filtered sea water or artificial sea water, see Table 2-11, p. 34; darkness; 22° C; food: newly hatched nauplii of *Artemia salina*; culture-medium change: twice daily, once about 30 mins to 1 hr after feeding, and again about 6 hrs later). The mean growth rate obtained for all cultures was $K = 0.32$; this represents a doubling time of about 2 days. At 11° C, all colonies died within 2 days. At high temperatures (34° C), stolonial growth increased and stem growth declined, resulting in colonies that were lower and more spread out than those grown at lower temperatures. The mean growth rate obtained in 100% artificial sea water was slightly higher than that recorded in 100% filtered natural sea water (0.31). Growth rates were high at feeding intervals of 0.5 and 1.0 days (0.30 and 0.25); they dropped significantly at 3.0 days (0.17), and approached zero at 7.0 days.

Ionic-requirement tests on *Bougainvillia* sp. indicate absolute requirements for potassium, calcium, magnesium and chloride ions (TUSOV and DAVIS, 1971). In the absence of sulphate ions, growth was possible only at very reduced rates.

In cultures of *Bougainvillia* sp., BERRILL (1949b; see also WERNER, 1961) reports differential growth promotion by temperature of stolons, hydranths and gonophores: high temperatures support primarily stolons, medium temperatures hydranths, and

low temperatures gonophores. However, on the basis of their studies on *Bougainvillia* sp., TUSOV and DAVIS (1971) came to the conclusion that in their material such structural differentiation is not solely determined by temperature, but also by some other factor(s) whose nature is still unknown. They obtained higher hydranth growth at 28°, 30° or 34° C than at any of the lower temperature levels tested, and gonophore production did not occur, even at temperatures as low as 11° C, except when the cultures were neglected.

Campanularia flexuosa

The colonial hydroid *Campanularia flexuosa* has been kept under laboratory conditions by CROWELL (1953, 1957), CROWELL and WYTTENBACH (1957), BROCK and STREHLER (1963), STREHLER (1964), WERMUTH and BARNES (1967, 1969) and WYTTENBACH (1968, 1969). CROWELL (1953) established cultures by tying a short piece of a freshly collected *C. flexuosa* colony to a microscope slide. The hydroid attaches itself with newly grown stolon tissue in 24 to 48 hrs. From the stolon new stems arise and, after a few days, the original colony portion can be cut away. The slides were placed in running, filtered, aerated and thermally adjusted sea water (WYTTENBACH and co-authors, 1965). *C. flexuosa* grows well at 17° to 18° C and feeds on larvae of *Artemia salina*. After a few days, each hydranth undergoes regression; its substance is resorbed and in about a day, a new hydranth develops on the same stolon. A colony constantly rebuilds its individuals; old hydranths are replaced by new ones, according to a predetermined regression order proceeding from the base to the top of a stem. Under environmental stress, hydranths tend to regress sooner.

When *Campanularia flexuosa* receives optimal amounts of nutrients, growth rate remains maximal for about 10 days, then gradually reaches a new and lower level which is maintained thereafter (CROWELL and WYTTENBACH, 1957). Older parts of stems are generally less efficient in producing terminal hydranths than younger ones. The mechanisms of inhibition of growth and differentiation require detailed investigation. However, genetic variation in the mode of stolon growth complicates such research (WYTTENBACH, 1969). Variations in stolon growth among different genera of colonial hydroids have been analyzed by WYTTENBACH and co-authors (1973).

Clava multicornis

Clava multicornis has been bred in different temperature-salinity combinations by KINNE and PAFFENHÖFER (1965, 1966) and PAFFENHÖFER (1968). Single polyps were cut off from a colony and their 5- to 8-mm long stolon was tied to a submersed glass plate (80 × 80 mm). The polyps grew new stolonial material and thus attached themselves to the plate within 4 to 8 days. The glass plates were placed vertically in a round culture container (150 mm diameter, 110 mm high) filled with 1000 ml of stagnant, Seitz-filtered culture water and covered by a glass lid. The culture water was renewed at 24-hr intervals following daily feeding (7- to 8-day-old larvae of *Artemia salina*).

Clava multicornis feeds on a large variety of animals including crustaceans,

annelids, pieces of molluscs and fish larvae. The colonies tolerated temperatures between 6° and 22° C and grew well between 11° and 17° C; at 22° C, polyps survived only 5 days. The test salinities 16‰, 24‰, 32‰ and 40‰ turned out to be well within the tolerance range. In 32‰S, numerous gonophores were produced at 11° and 16° C.

Colonies of *Clava multicornis* have been raised from winter stolons and from planula larvae by FØYN (1927a, b) in Petri dishes, as well as in aquaria with aerated stagnant and with non-aerated running sea water. (Daily change of the paper-filtered stagnant sea water; daily handfeeding of single polyps with small foot pieces of *Mytilus edulis*.) The Petri-dish cultures were covered by a lid and kept in natural or artificial illumination during the day-time, since they developed better under such conditions than in darkness. FØYN obtained planulae from older female polyps carrying larvae in their gonophores. The positively phototactic freshly hatched planulae aggregated in a light gradient and were pipetted into culture dishes.

Cordylophora caspia

The colonial brackish-water hydroid *Cordylophora caspia* (syn.: *C. lacustris*) has been reared and bred by KINNE (1956, 1958) under a variety of temperature (10° to 23.5° C) and salinity (fresh water to 30‰) conditions in Petri dishes (10-cm diameter, filled 1 to 1.5 cm high with stagnant, double-filtered culture water), covered with a glass lid. The culture water was renewed at 1- to 2-day intervals. It was mixed from tap water (treated for 6 weeks in a large, aerated, biologically balanced aquarium containing freshwater plants and animals) and Baltic Sea water (the latter was concentrated with sea salt in order to obtain higher test salinities of 24‰ or 30‰).

Cordylophora caspia was fed oligochaetes *Enchytraeus albidus*, *Pachydrilus lineatus* and pieces of *Lumbricus terrestris*, as well as larvae of *Artemia salina*. Occasionally, the colonies also received Baltic Sea copepods and *Daphnia magna*. At 1- or 2-day intervals, the cultures received an unrestricted food supply several hours before culture-water exchange. Sexual reproduction was obtained at temperatures between about 14° and 17° C and in salinities between 5‰ and 16.7‰S. Optimum temperatures for colony development ranged from about 11° to 18° C; optimum salinities from about 2‰ to 18‰S. Maximum growth rates were obtained in 16.7‰S. The range of temperatures and salinities in which life cycle and basic functions and structures remain unimpaired—the norm range—lies between 8° and 20° C and 1‰ and 24‰S (KINNE, 1956). *C. caspia* colonies kept at temperatures between 8° and 16° C can survive without being fed for up to 6 months (much longer at temperatures below 8° C). Starvation capacity is a function of salinity; it decreases in the order fresh water, 5‰, 16.7‰S. Below 2° to 4° C, hydranths retrograde and colonies attain the menont stage.

Functional and structural responses of cultured *Cordylophora caspia* to temperature and salinity have been summarized in Volume I. *C. caspia* colonies obtained from different habitats may exhibit different environmental requirements and different growth rates (ROCH, 1924; KINNE, 1956, 1958; FULTON, 1960, 1963a; GOSSELCK, 1969; ARNDT and FELBER, 1971). LESH-LAURIE (1972) has obtained

precocious development of sexual reproductive structures in colonies grown in the absence of a suitable substratum.

FULTON (1960, 1962) cultivated his *Cordylophora caspia* colonies on microscope slides slanted in 100-ml glass beakers at 22° C. In accordance with KINNE (1956, 1958), secondary colonies were started by cutting single hydranths from a well-developed colony and tying them (silk thread) individually to the substratum. At the cut, new stolonial tissue develops and attaches itself to the slide, while the hydrocaulus continues to elongate and finally begins to branch. Slanted-slide cultures can be grown to higher densities than those grown on the horizontal bottom of glass dishes. Instead of natural brackish water, FULTON used 'Cordylophora culture solution' (CCS 5) containing NaCl, 0.05 M; KHCO₃, 0.001 M; CaCl₂, 0.005 M; and MgCl₂, 0.005 M. The solution is made up in demineralized water;

Table 5-22

Culture medium used for *Cordylophora caspia* (Based on FULTON, 1960, as modified by ARNDT and FELBER, 1971; reproduced by permission of University of Rostock)

Component	Salinity			
	2‰	6‰	14‰	42‰
	(g 20 l ⁻¹ distilled water)			(g l ⁻¹)
NaCl	28.5	85.5	199.3	29.9
CaCl ₂ ·6H ₂ O	10.7	32.1	74.8	11.2
MgCl ₂ ·6H ₂ O	9.9	29.7	69.4	10.4
KHCO ₃	0.97	2.92	6.80	1.02
Chelaplex III-2H ₂ O	0.53	1.30	3.74	0.56

addition of 1.5×10^{-4} molar disodium diethylenediamine tetraacetate ('versenate') chelates heavy metals and makes it possible to prepare CCS 5 in tap or distilled water. Sodium, potassium, calcium and chloride ions turned out to be absolute requirements for growth, while in the absence of magnesium ions, growth continued, but at a reduced rate. Bicarbonate ions are not required, but serve to buffer the solution. As food, FULTON used washed, freshly hatched nauplii of *Artemia salina* reared under standard conditions. Each day, he offered an unrestricted amount of food for about 1 hr. After allowing the hydroids to feed to satiation, the culture medium was changed. A second medium change, several hours later, proved necessary for obtaining maximum growth. FULTON's culture method has permitted continual asexual development of a *C. caspia* clone for over 2 years and facilitated high growth rates.

Employing the culture solution of FULTON (1960), ARNDT and FELBER (1971) examined the effects of different salinities on *Cordylophora caspia* and measured oxygen consumption. The medium used by ARNDT and FELBER is listed in Table 5-22.

Dipurena reesi and *Eirene viridula*

Dipurena reesi and *Eirene viridula* have been cultivated in Petri dishes of 9-cm diameter (about 55 ml culture water) in sterilized North Sea water and fed larvae of *Artemia salina* (GÜNZL, 1959, 1964, 1968, 1973). Since *D. reesi* grew better in illuminated than in dark cultures, this hydroid polyp was exposed to a 12-hr day. In both species, sudden temperature elevation (e.g. from 20° to 29° C) induces the formation of medusa buds. Temperature change has been shown to induce medusa formation also in other hydroids: *Craspedacusta sowerbyi* (REISINGER, 1957), *Rathkea octopunctata*, *Bougainvillia superciliaris* and *Eucheilota maculata* (WERNER, 1958, 1961, 1968).

Colony growth and medusa budding of *Eirene viridula* have been examined by BIERBACH and HOFMANN (1973), who studied slide-grown, as well as non-attached, free-floating colonies exposed to a variety of temperature conditions. In sea water of 20°, 25° and 29° C, most slide-grown colonies attained a larger final size than their free-floating counterparts (Boveri dishes, pasteurized, stagnant North Sea water; food: *Artemia salina* nauplii offered twice a week; pipette-washing and water change about 3 hrs after feeding). Apparently, medusa budding does not depend on a certain minimal colony size; after temperature increase (e.g. from 20° to 25° or 29° C), even single hydranths are able to produce medusa buds.

Hydractinia echinata

After shipment of colonies on their natural substrate (shell of the gastropod *Littorina littorea*), sexual polyps (blastostyles) of *Hydractinia echinata* were removed with a scalpel from the shells, cleaned and transferred to a Boveri dish (HAUENSCHILD and KANELIS, 1953). They were then cultivated in stagnant, non-aerated, filtered and sterilized North Sea water. Blastostyles always released their sexual products in the morning, some time after the first exposure to light. Such synchronization facilitates contact between eggs and spermatozoa within the fertile period (1/2 to 1 hr after gamete release). In darkness, gamete release is delayed, but not completely suppressed. At room temperature, planula larvae develop within 2 days. The considerable variation in the percentage of successfully completed metamorphoses (0–70%) and in the time span required to attain the polyp stage (3 to 15 days), as well as the many structural abnormalities observed, appear to indicate non-optimal culture conditions. Qualitatively insufficient food (*Artemia salina* larvae) leads to colonies which consist only of stolons and nutrient polyps. Exclusive feeding on freshly hatched *A. salina* and lack of water movement (mechanical stimulation) were later (HAUENSCHILD, 1954, 1956a) shown or suggested to represent abnormal situations for *H. echinata* colonies.

Hydractinia echinata has been maintained in clone cultures over many years. Different clones exhibit different abilities to fuse with their stolons and to form, by such fusion, chimeric colonies. The genetic factors which determine the degree of tissue compatibility have been analyzed by cross-breeding experiments (HAUENSCHILD, 1954, 1956a). Consistency of intermediate forms of incompatibility between related strains (i.e. parent-offspring, half-sibs) suggests genetic control of histo-incompatibility and hyper-plastic growth (IVKER, 1972).

Studies by MÜLLER (1969a) revealed that planula larvae of *Hydractinia echinata* metamorphose only when in contact with certain substrate-covering bacteria. Gram-negative bacteria release, at the end of their exponential growth phase, a stimulating principle (MÜLLER, 1973). The stimulus is liberated by stationary cells previously cultivated at low population densities (up to 10^7 cells ml^{-1}). Transfer into sea water which lacks a nutrient supply comparable to that previously offered to the bacteria cultures (e.g. meat extract) enhances the inductive capacity of the bacteria. According to MÜLLER, the concentration of the inducing agent normally surpasses the threshold level only in the immediate micro-environment of living cells. But when shocked (sudden reduction in osmotic pressure), the bacteria discharge increased amounts which become traceable in the filtered cell-free medium. In this way the inducer can be accumulated and isolated. The active principle can be precipitated from the dissolved organic substances leaked out of the bacterial cells with acetone and extracted with chloroform. MÜLLER describes the inducer as an unstable, non-dialyzable, polar lipid. In order to induce complete metamorphosis in *H. echinata* larvae, the isolated agent must be applied in a pulse-like fashion (see below). The inducing effect of the bacterial principle is antagonized by ouabain. Conversely, high doses of isolated leakage material abolish ouabain inhibition.

According to MÜLLER and BUCHAL (1973), metamorphosis of planulae can be induced by a pulse-type (2 to 3 hrs) exposure to the ions of caesium, rubidium, lithium and potassium. Caesium induction is based upon active events indicating the involvement of a carrier-like system. Indirect reaction kinetics, taking the velocity of the larval response versus the dose as measure of cation uptake, yield Michaelis-like saturation curves. Potassium-induced stimulation is an ouabain-insensitive event governed by the Gibbs-Donnan principle. The ions act by stimulating the Na^+/K^+ -transport ATPase. Hence, induction of metamorphosis by monovalent cations is due to alterations of membrane-bound functions. This fact applies to bacteria-induced metamorphosis as well. HERRMANN (1975 and personal communication), who established bacterial metamorphosis initiation in the tentaculate *Actinotrocha branchiata*, hypothesizes that, ultimately, changes in the electrokinetical potential between bacterial substratum and setting marine invertebrate larvae constitute the metamorphosis-inducing factor; the setting larvae are assumed to be 'caught' in an electrokinetical gradient rather than to be actively selecting the substratum.

MÜLLER (1961a, 1964, 1967, 1969b) has also investigated differentiation processes in stolons and different types of polyps, as well as the degree of sexual stability. Spawning in *Hydractinia echinata* is induced by dark-light changes in the morning. The normal daily spawning rhythm can be modified and shifted *ad libitum* if the dark-light phases are varied experimentally (MÜLLER, 1961b).

Obelia Species

Obelia species have been kept under laboratory conditions for studies on structural dedifferentiation (e.g. HUXLEY and DE BEER, 1923); the role of amino-acids and nucleic-acid components in development and growth (HAMMETT, 1943); correlations between hydranths (HAMMETT, 1946); reproduction (e.g. BERRILL,

1948a); and polymorphic transformations (BERRILL, 1949a). The culture methods employed were similar or identical to those used for other colonial hydroids.

Pennaria tiarella

The colonial hydroid *Pennaria tiarella* has been grown on glass slides in slide racks placed in finger bowls containing continuously aerated artificial sea water ('Instant Ocean', Table 2-12, p. 34) with a specific gravity of 1.025, made up without the trace-element additives (REES, 1971). The finger bowls were cleaned of debris daily with a pipette, and the culture medium was changed every 3rd day. REES maintained all cultures at 'ambient laboratory temperatures' and fed *P. tiarella* to repletion once daily with nauplii of *Artemia salina*. Food taken up by the terminal hydranth was distributed throughout the entire colony within 30 mins after ingestion (radio-activity measurements). At that time the radio-activity appeared as a gradient, decreasing in proportion to the distance of the tissue examined from the terminal hydranth. The central stem was the most radio-active part of the colony. In growing colonies, radio-active food seemed to be preferentially utilized by growing regions. X-irradiation effects on regeneration of *P. tiarella* have been studied by PUCKETT (1935).

Podocoryne carnea

A polymorphic hydroid normally growing on gastropod shells inhabited by hermit crabs, *Podocoryne carnea* has been cultivated on microscope slides placed in a glass slide tray which, in turn, was hung in an aquarium containing 12 or 15 l of sea water (BRAVERMAN, 1962). The water was kept in continuous motion (e.g. by a motor-driven glass propeller fitted to a long rod) and aerated. *P. carnea*, as most other hydroids, eats only living food (e.g. nauplii of *Artemia salina*). Female clones respond to excess (2%) CO₂ analogous to *Hydra* species.

Difficult-to-cultivate Species

Some colonial hydroids proved especially difficult to cultivate. Examples are *Eudendrium armatum* and species of *Tubularia*. Newly captured *E. armatum* deteriorated soon after transfer to laboratory conditions; within a few hours the polyps began to retrograde (WASSERTHAL, 1973). The same response has been reported by several authors for *Tubularia* species. Hence, most studies on growth and reproduction or on morphogenesis and regeneration (e.g. TARDENT, 1963) are based on field observations or on freshly collected material.

Tubularia crocea is the first member of the genus that has been cultivated successfully over 10 weeks (MACKIE, 1966). According to MACKIE, his success is based on (i) frequent renewal of culture water, (ii) use of the purest natural sea water available, (iii) cooling (14° C), and (iv) water movement. MACKIE provided water recirculation with the help of a peristaltic pump (metal rollers squeeze the water along an elastic tube) installed in a 100-l recirculation system, and filtered the water through muslin. Various other animals were kept in the culture tanks (hydromedusae, siphonophores, mussels and small fishes). The *T. crocea* colonies

were attached to a microscope slide, allowed to rest on the tank bottom, or to hang from a thread near the top. They were shielded from direct sunlight and fed first marine plankton, later *Artemia salina* nauplii (usually one meal day⁻¹). The cultures never developed the long, pendulous racemes which wild specimens sometimes show. MACKIE assumes that if more food had been given, the racemes might have grown longer and the hydranths attained a slightly larger size. Pycnogonids and amphipods, often associated with *T. crocea* colonies, must be removed. The former are actively destructive; the latter do not feed on the hydroid, but are immune to its nematocysts and sometimes cause lacerations.

MACKIE (1966) recorded continuous growth in stolons and hydrocauli of *Tubularia crocea* and described the growth pattern for an established colony and for settled actinula larvae. Mature hydranths retain full regenerative capacities. Although shedding of hydranths was seen, most hydranths remained intact. Presumably, hydranth shedding is associated with poor water conditions, and regression of colonies appears to be due to unsuitable environmental conditions—such as temperatures above 18° to 20° C (MORSE, 1909; ELMHIRST, 1922, 1923; MOORE, 1939; BERRILL, 1948b, 1952).

Further papers involving cultivation of *Tubularia* species have been presented by MORGAN (1902, 1903), BENOIT (1925), BEUTLER (1925), DAVIDSON and BERRILL (1948), STEINBERG (1954), TARDENT and TARDENT (1956), ROSE (1957) and JOSEPHSON and MACKIE (1965).

(d) Anthozoa

In some anthozoans, rearing from fertilized eggs is relatively easy, especially in species which release their young at an advanced stage of development. The young must be hand-fed individually at regular intervals (e.g. once a day). Plankton, pieces of molluscs, oligochaetes, crustaceans or fishes have commonly been used as food sources. Anthozoa are predominantly or exclusively carnivorous.

APPELLÖF (1901) reared *Urticina crassicornis*; HINRICHS (*in*: HAGMEIER, 1933), *Cerianthus lloydii*; GEMMILL (1920), *Metridium dianthus* and *Adamsia palliata*. The eggs of *U. crassicornis* are large (0.6 mm) and yolk-rich; presumably, no feeding is required before larval settlement. *C. lloydii* larvae have been fed microplankton (regularly replaced stagnant water); upon settling (body bends 90°), they were transferred to a culture glass with sand or other suitable substratum, where they soon began to dig themselves in; at low population densities and in running sea water, they developed well on small pieces of *Enchytraeus albidus*. Larvae of *M. dianthus* leave the eggs (0.1 mm) at the blastula stage which, apparently, can develop into the benthic stage without feeding. *A. palliata* eggs (0.25 mm) are opaque, of varying colour (red, yellow, white) and float in the water. Blastulae swim with their aboral pole directed forward. While the youngest stages tend to swim towards the surface, older ones swim primarily horizontally near the bottom. They settle first temporarily (testing period), then definitely, on mollusc shells (but not those inhabited by eupagurids), as well as on stones, gravel or glass.

In addition to the studies reviewed below, papers on laboratory maintenance of coral larvae have also been written by BOSHMA (1929), STEPHENSON (1931), MARSHALL (1932), MARSHALL and STEPHENSON (1933), STEPHENSON and

STEPHENSON (1933), ABE (1937), KAWAGUTI (1941), ATODA (1947, 1951a, b) and EDMONDSON (1946).

Alcyonium digitatum

This octocorallian, known as 'dead men's fingers', has been reared from eggs by MATTHEWS (1916). Freshly caught reproducing colonies were placed in running sea water. Since the colonies kept well only for a few days, the healthiest looking and most mature (dark red eggs, opaque white sperm clumps) colonies were selected. After a few hours, the water flow was stopped, whereupon the polyps extended, and spawning began in the stagnant water. Some colonies released eggs over several days. While the eggs floated in the water, the male colonies released spermatozoa. Fertilized eggs were removed (pipette) and transferred to finger bowls with filtered or untreated natural sea water. The eggs (0.5 mm) are yolk-rich and planulae metamorphose without feeding; as the yolk is used up, the red colour disappears. Apparently, even young polyps live for some time on yolk; later, they accept larvae of *Leptoclinum* sp. and *Botrylloides* sp. as food, as well as copepods and nauplii of *Balanus* species. Plant food offered (species of *Nitzschia* and *Pleurococcus*) was not eaten. Colony development proceeded only after two finger bowls were placed on a floating device anchored in the sea; after 6 months, 32 polyps had developed in the largest colony.

Fungia scutaria and *Pocillopora damicornis*

When stimulated to ingest small amounts of (radio-active) bacteria suspensions mixed with plankton homogenate, these two corals digested the bacteria and, apparently, hydrolyzed and assimilated them (DISALVO, 1971). Usually, the surfaces of living corals carry a rich bacterial flora. However, none of the corals examined would retain several species of washed bacteria cells; instead, they trapped these cells with mucus and moved them by ciliary action. When they did swallow the cells, they regurgitated them within an hour. A particle extract of plankton was handled much the same way. These observations pertain to both the possible role of bacteria as food source and the presence of an effective defence mechanism against microbial invasion. Further research is needed to elucidate these two aspects more fully.

Fungia scutaria incorporates metabolically produced CO₂ into its skeletal carbonate (PEARSE, 1971). This fact was established by feeding ¹⁴C-labelled food to cultured corals and by determining the ¹⁴CO₂ released from their skeletons. In *Pocillopora damicornis*, calcium uptake is significantly affected by temperature. The peak temperature is 27° C with a rapid decline in rate on both sides (CLAUSEN, 1971).

The chemical composition of coral matrices has been analyzed by YOUNG (1971), who confirmed WAINWRIGHT's (1963) finding that chitin is the major component in *Pocillopora damicornis*. Interspecific comparison reveals a surprising diversity of matrix composition among corals and a lack of correlation to taxonomic classification.

Planulae and newly settled polyps of *Pocillopora damicornis* have been raised by REED (1971). Coral heads were removed from the reef and transported to the laboratory in buckets of sea water. If overcrowded, the corals deteriorate rapidly and die. When present, planula larvae are expelled by the polyps almost immediately after collection. As the larvae emerged, REED pipetted 20 to 50 of them to small glass boxes just submerged in a finger bowl filled with filtered, aerated sea water. The boxes were formed of microscope slides held together with cellophane tape: 3 slides formed the bottom, 4 slides the sides of the box. The planula larvae were transferred daily into clean boxes with fresh sea water. If any larvae attached to the surface of the slides during a 24-hr period, the box was carefully dismantled and the individual slides with the newly affixed polyps were transferred to new sea water. Although they easily immobilize nauplii of *Artemia salina* with their nematocysts, the planulae do not feed before settling. After developing tentacles, the young polyps can catch and swallow the nauplii. Extracts of commercially available frozen *A. salina* adults elicit a strong feeding response in the settled coral polyps. The polyps also readily accept a variety of animal tissues (e.g. minute pieces of fish muscle or of liver from mice and geckos) placed on their tentacular surface.

Ptilosarcus guerneyi

Freshly collected sea-pen *Ptilosarcus guerneyi* spawned on 3 consecutive days in the laboratory (CHIA and CRAWFORD, 1973). The sea-pens were maintained in a sea-water tank (no details stated). Spawning occurred in late March. Several individuals each released their gametes between 15.00 and 18.00 hrs after exposure to bright sunlight. Before spawning, all individuals were fully expanded. Gamete release began at the upper end of the rachis and was accompanied by a slow wave of contraction of the 'leaves'. The gametes were expelled through the mouth of feeding polyps. Immediately after gamete release, the eggs were fusiform; after 30 mins, they had rounded. Freshly released eggs were orange in colour and floated at the water surface; in contrast, the spermatozoa dispersed soon after discharge. Almost all eggs in the tanks turned out to be fertilized. CHIA and CRAWFORD collected fertilized eggs, placed them in glass dishes at 12° C and changed the culture water 'periodically'. Some metamorphosed individuals were fed *Artemia salina* nauplii. CHIA and CRAWFORD describe gametogenesis, oogenesis, spermatogenesis, cleavage and other aspects of early ontogeny and discuss predator defence mechanisms.

Zoanthus sandwichensis

Zoanthus sandwichensis does not feed on *Artemia salina* nauplii nor on any of the other usual food organisms. It may satisfy its nutritional needs by (i) accumulating organic material from solution; (ii) 'farming' bacteria within its coelenteron and feeding on them; (iii) symbiotic zooxanthellae (REIMER, 1971). Possibly, the uptake of small molecules from solution provides this zoanthid with nitrogen, phosphorus, trace metals and other inorganics; bacteria may provide complex organic materials such as vitamins; and the zooxanthellae may provide reduced

organic carbon. REIMER suggests that the capacity of *Z. sandwichensis* to accumulate amino acids from solution may be nutritionally significant. The zoanthid accumulated about 65% of the ^{14}C -glycine present in the culture water at a concentration of 2.16 mg l^{-1} .

Other Species

The corals *Manicina areolata*, *Montastrea cavernosa* and *Porites porites*, common in Caribbean and Bermudan waters, have been maintained in a 102-l aquarium filled with artificial sea water ('Instant Ocean') of 35‰S at a temperature of 24°C and pH values between 7.5 and 8.0 (COLES, 1969). Food rations (modification of SLOBODKIN's 1964 method) consisted of living, compacted *Artemia salina*. Estimates of feeding and respiration do not rule out the possibility that algal symbionts provide a significant or even dominant energy source for the three corals. The cultures were exposed to light from an adjacent window and daylight white fluorescent tubes; maximum incident illumination was about 5400 lux.

Feeding experiments on 6 species of common scleractinian reef-building corals from the Bismarck Archipelago have been conducted by SOROKIN (1973). The corals are reported to be capable of utilizing planktonic bacteria and dissolved organic matter (protein hydrolyzate) as food sources (radio-carbon test). The amount of organic carbon assimilated per day, at food concentrations approaching those found in the natural habitat, was equivalent to 10 to 20% of the carbon content of the polyp bodies. Rates of consumption and assimilation of planktonic algae were significantly lower.

Collected in Sagami Bay, Japan, 3 individuals of the sea-anemone *Anthopleura midorii* were kept in one glass vessel ($45 \times 23 \times 30 \text{ cm}$ deep) containing 20 l of sea water (NAGAI and NAGAI, 1973). The culture water (15° to 20°C) was aerated and circulated (ca 4 l hr^{-1}) by an airlift and passed through a filter made of glass wool and sand. Each sea-anemone was provided with a stone for attachment. The culture vessel was cleaned bimonthly. *A. midorii* received as food primarily pieces of short-necked clam *Tapes japonica* and carp *Cyprinus carpio*.

Chemical Aspects of Feeding

Chemical aspects of anthozoan feeding have been studied in several Hawaiian corals by MARISCAL (1971). *Cyphastrea ocellina* was investigated in more detail; less intensively examined were *Fungia scutaria*, *Pocillopora damicornis*, *P. meandrina*, *Tubastrea manni*, *Porites compressa* and *Lepastrea bottae*. The feeding behaviour of the sea-anemone *Anthopleura midorii* has been investigated by NAGAI and NAGAI (1973). Successive feeding activities consist of (i) tentaculation of any solid object; (ii) retention of prey by tentacles; (iii) mouth opening; (iv) food ingestion; (v) food digestion; (vi) extrusion of non-digestible material. Water-soluble extract of *Tapes japonica* ($362 \mu\text{g}$ of dry matter) induced complete feeding responses in dilutions ranging from 1 to 80. A synthetic diet containing a single amino acid (alanine, glycine or histidine) activated only tentacular food retention.

Cyphastrea ocellina, *Fungia scutaria*, *Pocillopora damicornis* and *P. meandrina* perform wide-mouth openings in response to live prey (zooplankters such as crab

megalops, mysids, caridean larvae, chaetognaths or *Artemia salina*) or to sea-water extracts of these prey organisms. The major activity for mouth opening is ascribed to proline and glutathione, presumably released through wounds inflicted by the nematocysts.

In cultured sea-anemones *Bolocerooides* sp., feeding responses were found to be activated by the amino acid valine (LINDSTEDT, 1971). While isoleucine served as a competitive inhibitor, leucine did not; no feeding response to valine dissolved in sea water was observed unless the sea-anemone were simultaneously presented with an inert object. The sea-anemone *Aiptasia* sp., cultivated in Petri dishes (about 40 ml of sea water), has been shown to incorporate free ^{14}C -proline, injected into their coelenteron, into bound ^{14}C -proline and bound ^{14}C -hydroxyproline (GOSLINE, 1971). Methodological deficiencies involved in assessing the contribution of the tissue of *Aiptasia* sp. to the nutrition of the algal symbiont have been discussed by COOK (1971).

(e) Cnidaria as Assay and Food Organisms

Many cnidarians are good assay organisms. Once attached to a substratum, they are easy to handle and often respond sensitively to environmental change. Stenoplastic forms can be used for assessing minute variations in the environment. Useful criteria are: hydranth reduction, growth rate (asexual reproduction) and gonophore formation (sexual reproduction). The proliferous asexual reproduction makes it possible to obtain large numbers of individuals with identical genetical and environmental backgrounds (e.g. KINNE, 1956, 1958). Since the cells of active hydranths are in immediate contact with the surrounding water, pollutants affect the tissue directly.

The first cnidarians used as assay organisms were species of the freshwater-living genus *Hydra* (see especially the papers by LOOMIS, 1953, 1954; LOOMIS and LENHOFF, 1956; LENHOFF, 1971; LENHOFF and BROWN, 1970; LENHOFF and co-authors, 1971). Among the marine hydroids, the campanulid thecate *Eirene viridula* has been used as assay organism to assess the toxicity of water pollutants (KARBE, 1972). KARBE cultivated *E. viridula*, according to a method outlined by WERNER (1968; see also p. 652), in 200-ml glass bowls at 20° C in natural sea water of ca 30‰S. For experiments, stolon pieces with a few polyps were isolated and string-fastened to a microscope slide until firmly attached. Each newly attached secondary colony was fed twice a week with an excess amount of 3-day-old larvae of *Artemia salina*. One hour after feeding, the colonies were carefully washed and transferred into a new culture enclosure. The criteria used to assess the toxicity of water pollutants were: tissue disintegration, morphological changes, tissue reorganization, growth rate, and reduction of hydranths. Critical heavy-metal concentrations cause functional and structural responses which are similar to those observed in *Cordylophora caspia* under thermal and osmotic stress (KINNE, 1956; see also Volume I, p. 513 and pp. 984–987). Threshold concentrations for acute effects of zinc, lead, cadmium, copper and mercury are: 1.5 to 3 ppm Zn, 1 to 3 ppm Pb, 0.1 to 0.3 ppm Cd, 0.03 to 0.06 ppm Cu, 0.001 to 0.003 ppm Hg.

The sensitivity of *Tubularia crocea* to changes in water quality (p. 660) has been used by WEST and RENSHAW (1970) for assaying culture-medium conditions.

Whenever the culture water became 'fouled', *T. crocea* would shed its hydranths before the *Clytia attenuata*—the hydroid primarily cultivated by WEST and RENSCHAW—was affected. Changing the filter sand with natural beach sand usually eliminated the water-quality problem. Using the responses of a stenoplastic form as water-quality criteria for the more euryplastic animal cultured opens up new means for culture-water treatment (Chapter 2, p. 100). However, it does not contribute to solving the central problem of the cultivator: the management of water quality for stenoplastic forms.

Although other cultivated animals have been offered cnidarians as food, e.g. opisthobranchs and polychaetes (p. 727), the importance of cnidarians as food organisms has not yet been fully explored. No papers have come to the reviewer's attention in which members of this phylum have been mass-cultured with the main purpose of providing food for other cultured animals.

(f) Cnidaria: Conclusions

Cnidaria have received considerable attention from experimental ecologists. In most cases, the culture methods employed were relatively simple. Some sedentary forms have been cultivated with considerable success (over several years) in small shallow dishes with stagnant sea water, renewed at certain intervals. In such batch cultures, food remains must be removed regularly and carefully. Another means to take care of food remains is the introduction of culture partners which consume the debris as it accumulates (p. 602). Free swimming medusae develop best in larger, cylindrical culture enclosures. Corners act as traps and rough surfaces cause lacerations. Water movement or running water may sometimes be advantageous, but numerous medusae develop well in regularly renewed stagnant sea water. Where aeration is required, care must be taken to avoid direct contact between air bubbles and cnidarians.

Among the cnidarians sustained in culture, food specialists are rare. Most representatives have accepted a large variety of plankters and animal tissues. Some forms, especially corals, rely on autotroph symbionts. *Zoanthus sandwichensis* has thus far refused to feed on any of the food organisms offered; possibly it thrives on dissolved organic matter, bacteria and zooxanthellae.

In a few cultivated cnidarians, morphological and sexual differentiation have been analyzed to an extent where the experimenter can exert considerable control: sexual differentiation and reproduction, for example, can be controlled predictably in some forms by changes in CO₂-partial pressure (LOOMIS and LENHOFF, 1956; LENHOFF and co-authors, 1971), nutrition (RUTHERFORD and co-authors, 1965), or changes in temperature (WERNER, 1955, 1963). Specific ion requirements have been established in some freshwater forms and for the brackish *Cordylophora caspia* (for details consult the review by LENHOFF, 1971). In the marine cnidarian *Hydractinia echinata*, normal tissue differentiation and metamorphosis require the presence of specific agents (substances released by bacteria, certain ion effects). Planulae metamorphosis can be induced by controlled exposure to the ions of caesium, rubidium, lithium and potassium (MÜLLER, 1969a, 1973; MÜLLER and BUCHAL, 1973).

Some cnidarians thrive well in unattended aquaria. However, as soon as the

cultivator begins to pay attention to them, in an attempt to improve and control the culture conditions, the colonies collapse and disappear. Such disappointing experience witnesses our insufficient know-how of the environmental and nutritional requirements of these forms.

Some species, e.g. *Tubularia crocea* and *Eudendrium armatum*, are extremely sensitive to changes in water quality. They readily shed their polyps or undergo polyp retrogradation in response to minute alterations in environmental conditions. Two phenomena seem to be involved here: genetically controlled stenoplasticity and non-genetic adaptation (acclimation) of polyp tissue to local environmental conditions. Within the genetically fixed environmental range, individual polyps seem to acclimate to rather specific conditions. Apparently, acclimated polyps function optimally only under these conditions at the expense of environmental versatility, collapsing upon the slightest change. Non-genetic adaptations of young or of newly reestablished polyps appear to represent the major means for individual accommodation in specific environments. In such cases, the culturist can do 3 things to reduce the difficulties encountered: (i) use young stages not fully acclimated; (ii) wait for readaptation of the material at hand; (iii) attempt to determine the essential factors in the original environment and to simulate and control these factors in his experiments as closely as possible.

Little definite knowledge is available on light effects. Most experimenters have paid no attention to illumination. Some insist that their cnidarians do equally well in light and in darkness. However, such generalization requires qualification and critical examination. In *Hydractinia echinata*, gamete release is induced by dark-light changes in the morning and can be controlled by changes in illumination (MÜLLER, 1961b). Cnidarians with autotrophic symbionts require light and, where tested, appear to grow best under defined irradiances and photoperiods.

In open sea-water systems, predator avoidance and control are essential. Opisthobranchs or pycnogonids, for example, may destroy a hydroid colony in a short time. Reports on bacterial infestations of Cnidaria cultures have not come to the reviewer's attention; but such infestations may, conceivably, be of importance, especially when the animals are weakened due to environmental stress or malnutrition (LAUCKNER (in press)).

A few cnidarians have been cultivated under *in situ* conditions. In species which have thus far resisted laboratory cultivation, in which food requirements are unknown, or in which laboratory-determined functional and structural performances require verification, *in situ* cultivation is the method of choice. Of course, control of environmental and nutritional conditions remains rather limited under *in situ* conditions.

Several cnidarians, especially sessile forms, possess excellent prerequisites for use as assay organisms: they are small; can be easily accommodated in culture; often respond sensitively to environmental change; facilitate comparison (clone cultures). In addition, sublethal responses can be assessed by a variety of functional and structural criteria.

The usefulness of Cnidaria as food organisms remains to be explored. Reviewing the evidence at hand on Cnidaria-eating invertebrates, SALVINI-PLAWEN (1972) concludes that numerous animals feed on cnidarians—either as predators or as parasites. Detrimental effects of nematocysts are often circumvented by

mechanical protection (e.g. cuticular lining of the pharynx) or by glandular action. Since hyper-viscosity reduces or prevents nematocyst discharge, most mucous secretions produce immunizing effects.

(5) Turbellaria

Except for an early study by KENK (1940), our knowledge on marine Turbellaria cultivation has been produced within the last two decades. During this period, some experimental ecologists have succeeded in disclosing exciting detail on life cycles and reproductive biology.

(a) Major Species Cultivated

Archaphanostoma agile, *Pseudaphanostoma psammophilum* and
Pseudohaplogonaria vacua

Freshly hatched acoelous *Archaphanostoma agile* from marine littoral sediments with a high detritus content, *Pseudaphanostoma psammophilum* from the marine mesopsammal, and *Pseudohaplogonaria vacua* from coarse-grained marine sublittoral sediments have been raised by APELT (1969) in round glass dishes (35 mm lower, 70 mm upper diameter; 35 mm high). The dishes were covered with glass lids; they contained sterilized, non-aerated sea water of 16° to 18° C. The turbellarians were exposed to a photoperiod of 14 hrs light. Diatoms *Nitzschia communis* or *N. ovalis*, isolated from the natural habitat of *A. agile*, served as food source for *A. agile* and *P. psammophilum*. Subadults of these two turbellarians were transferred into new sea water and fed once a week; adults, every 3 to 5 days. Sexually mature *P. psammophilum* had to be controlled daily, since they often became caught in their own slime during oviposition. A frequent bacterial disease of *A. agile* ('rote pest') required application of 0.25 g l⁻¹ *p*-aminobenzolsulphonacetamide. *P. vacua* received *A. agile* as only food source. Within a few minutes, hungry adult *P. vacua* consumed up to 6 fully grown *A. agile*. Young *P. vacua* (600–700 μm) feed on freshly hatched *A. agile*.

Archaphanostoma agile is capable of prolonged starvation. Non-fed individuals first resorb their oocytes, then their sexual organs, and finally the greater part of their somatic cells. Of 15 *A. agile*, starved at 16° to 18° C, 12 survived for 50 days; the body size of the survivors, which exhibited normal vitality, decreased to that of newly hatched young; when feeding was resumed, they regained their normal size after 20 to 25 days. APELT (1969) succeeded in keeping his *A. agile* cultures in a sexually reproductive condition for about 1½ years, almost without mortality.

Bursosaphia baltalimaniaformis, *Otocelis rubropunctata* and
O. westbladi

Bursosaphia baltalimaniaformis (Convolutidea), *Otocelis rubropunctata* and *O. westbladi* (Otocelidae) have also been cultivated by APELT (personal communication). These acoelous turbellarians inhabit detritus-rich sediments. All three are predators; they feed on nauplii of harpacticoid copepods and, predominantly, on ciliates.

APELT used the ciliate *Strombidium* sp. as sole food source; it inhabits the same biotope as the turbellarians and can be easily cultured. The turbellarians and their ciliate food were kept in crystallizing dishes (upper diameter: 8 cm; bottom diameter: 3.5 cm; height: 4.5 cm) covered by a glass lid.

The unaerated, stagnant culture medium was composed of 60 ml sterilized North Sea water (0.45- μ m Millipore filter), 30 ml of a dense culture of *Dunaliella* sp., 2 to 5 pinhead-sized pieces of *Mytilus edulis* flesh (dried to 80° C) and 5 to 10 ml of a dense *Strombidium* sp. culture. The ciliates feed on *Dunaliella* sp. and multiply rapidly in the culture enclosure. They tend to accumulate, especially at the bottom near the *M. edulis* pieces. The turbellarians must be transferred every 3 to 5 days into new medium because, after consuming their food, the ciliates disperse in the free water and become less accessible to the bottom-living turbellarians. Upon medium-mixing, the pH of the culture medium was about 8.4; after 3 to 4 days, it decreased to about 7.3. The cultures were exposed to temperatures of 15° to 17° C and a 12-hr light-dark rhythm. Some data regarding the reproductive potential of the three species are listed in Table 5-25.

Childia groenlandica

An inhabitant of intertidal beaches and mudflats, the acoelous *Childia groenlandica* was maintained by BOYER (1971) in finger bowls on a sea table. Larvae of *Artemia salina* served as food source.

Convoluta Species

The acoelous *Convoluta roscoffensis* carries symbiotic algae and, in this condition, is practically autotrophic. DOREY (1965) collected *C. roscoffensis* from red seaweed aggregations and established cultures at about 16° C. He decided to use large volumes, of water, and to incorporate an active-carbon filter. But even under these conditions, the reproductive rate gradually declined and the turbellarians acquired a characteristic pattern of degenerative features; no culture kept in this way survived for more than 4 months. More satisfactory results (4 generations kept for 10 months) were obtained in small volumes of sea water, freed from most foreign organisms, and enriched in such a way as to promote growth of the symbiotic alga *Carteria* sp. (see below). *C. roscoffensis* were kept in covered polystyrene boxes of 700 or 1000 ml capacity, containing 500 and 800 ml of culture water, respectively. Deep boxes (10 cm of water) were preferred to slow down evaporation. It was not necessary to provide sand, but a slow stream of air was injected into the water. The air had first been bubbled through a wash bottle of distilled water to increase humidity and thus to reduce evaporation loss from the culture medium.

The culture medium used by DOREY (1965) was a modification of that recommended for marine *Chlamydomonas* by HUTNER and co-authors (1950). It is prepared using the enrichment solution listed in Table 5-23. The resulting pH is adjusted to 4.0 with sodium hydroxide solution before the final volume is made up; 10 ml of this fluid are added to 1 l of sea water, and the mixture (which has a pH of about 6.5) is steamed for 30 mins at 95° C. After cooling, the pH is restored to 7.8 by

addition of 10 ml N/20 sodium hydroxide (at pH 7.8 the final medium would precipitate if heated to 95° C). The culture medium must be replaced every 10 days. DOREY excluded foreign organisms other than bacteria by carefully washing the turbellarians with culture medium. Free-living specimens of the symbiotic alga *Carteria* sp. cannot be excluded in this way, since a few symbionts are extruded with the mucus of each egg cocoon and proliferate rapidly as free-living flagellates. Excessive populations of free-living *Carteria* sp. must be prevented by washing *Convoluta roscoffensis* and the culture boxes during routine medium changes. Hatchlings are particularly susceptible to the detrimental effects of high concentrations of free flagellates.

DOREY (1965) placed the culture boxes about 5 cm from a 40-W fluorescent tube. Growth was promoted by continuous illumination; however, occasional 12-hr periods of darkness tended to improve reproduction. Since hatchlings acquire symbiotic algae more quickly in the dark than in the light, during the first week

Table 5-23

Enrichment solution for preparing the culture medium for *Convoluta roscoffensis* (After DOREY, 1965; reproduced by permission of Company of Biologists Ltd.)

Component	Amount	Component	Amount
Ethylene diamine tetra-acetic acid (disodium salt, dihydrate)	25 g	MnCl ₂ · 4H ₂ O	1.8 g
NaNO ₃	20 g	FeCl ₃ · 6H ₂ O	1.5 g
ZnSO ₄ · 7H ₂ O	6.5 g	CuSO ₄ · 5H ₂ O	1.0 g
Na ₂ HPO ₄ · 12H ₂ O	3 g	(NH ₄) ₆ Mo ₇ O ₂₄ · 4H ₂ O	0.9 g
		Distilled water, to make 1000 ml	

they should be given several 12-hr periods of darkness in the presence of a moderate population of free-living *Carteria* sp. In cultures kept under these conditions, no extra food is required.

Convoluta roscoffensis, collected near Roscoff (France), have been cultivated by PROVASOLI and co-authors (1968) in glass vessels about 5 cm deep, covered with 10-cm Petri-dish lids kept at 15° C under fluorescent tubes (about 250 or 350 ft. c.; 14-hr day). Sterilized sea water was used as culture medium; it was treated with activated carbon and enriched with 1% by volume of ESI (a mixture of nitrate, phosphate, vitamin B₁₂, thiamine, a chelated trace-metal mixture, and Tris buffer at pH 7.8). The medium was normally changed every 4 to 7 days—if required, more frequently. Egg cocoons were laid 45 to 60 days after birth.

PROVASOLI and co-authors (1968) resynthesized the symbiotic condition of *Convoluta roscoffensis* by feeding new-born colourless larvae with various clones of *Platymonas convolutae*. 'Greening' was also brought about by feeding larvae with members of other algal species distinguishable from the natural symbiont by pyrenoid characteristics but subsequent growth rates of the greened larvae were lower, and more time was required for greening. When potential symbionts were added in competitive pairs, normally only one member of a pair caused greening;

the order of success was parallel to the order of infection efficiency obtained in experiments with single potential symbionts. A chimaeral condition, with two different symbionts present together, could be induced temporarily in an experiment designed to give an alien symbiont a very long start before admitting the one present under natural habitat conditions. Effective greening with *Prasinocladus marinus* did not impede prompt entry of *Platymonas convolutae*; the entry was followed by rapid and complete elimination of *P. marinus*. In spite of considerable diversity in the populations of free-living flagellates available to wild new-born larvae of *C. roscoffensis*, the affinity between the turbellarian and its normal symbiont *P. convolutae* is so high that its selective entry is ensured.

Studies on $^{14}\text{CO}_2$ fixation by *Platymonas convolutae* within cultured *Convoluta roscoffensis* (KREMER, 1975) suggest that glucose and fructose (not mannitol), as well as several amino acids, especially alanine, are transferred from the algal symbiont to the tissue of the turbellarian host.

Convoluta convoluta (syn.: *C. paradoxa*) grasps larger prey by the anterior end of its body and forces it through the mouth into the digestive tissue (JENNINGS, 1957; MAMKAEV and SERAVIN, 1963). While JENNINGS reports that up to one half of the digestive tissue can be extruded through the mouth in order to collect small organisms (pseudopod function), MAMKAEV and SERAVIN have seen such extrusion only at defecation. They hold ciliary currents responsible for transporting small food particles, via the mouth, into the digestive tissue.

Attempts to breed *Convoluta convoluta* failed (APELT, 1969). It was impossible to raise the freshly hatched young, since appropriate food could not be provided in sufficient quantities. Freshly hatched *C. convoluta* feed exclusively on plants, such as epiphytic diatoms and spores of red algae; only after they have acquired their symbionts, do they also feed on animals.

Monocelis Species

The proseriate *Monocelis fusca* inhabits coastal areas of North America, Arctic regions, North Sea, Baltic Sea and Mediterranean Sea. It has been cultivated for embryological studies by GIESA (1966). Pieces of algal mats were placed in a glass in darkness. After 1 to 2 hrs, the resulting oxygen deficiency caused *M. fusca* to accumulate at the algal surface. From there, the turbellarians were pipetted into shallow glass dishes (without substratum) filled to a height of 2 to 3 cm with water of 12.5‰ to 15‰S. The water was changed every 2 days and maintained at 19° to 21° C during egg deposition and early ontogeny. *M. fusca* can withstand temperatures from 0° to 28° C. Embryogenesis is most rapid at 23° to 24° C (5½ days).

Cultured *Monocelis fusca* eat pieces of a large variety of animals, e.g. of *Nereis diversicolor*, *N. virens*, *Lumbricus terrestris*, *Tubifex* sp., several crustaceans and planarians. Hepatopancreas of *Mytilus edulis* (but no other body parts) is sometimes accepted as food source. GIESA (1966) describes the process of food uptake and points out that individuals, starved for 3 or more days, strive to crawl upwards and out of the water (rapid, earthworm-like movements) as soon as light is switched on or upon vibration. This response may cause heavy losses (desiccation); it fades about 10 mins after cessation of the stimulus. Breeding of *M. fusca* over several generations is difficult. GIESA succeeded in maintaining one culture over 7 months

at 13° to 18° C (no offspring); a summer culture (19° to 21° C) yielded 2 generations (generation time about 29 days). The first generation grew rapidly, but the second suffered from reduced vitality.

Monocelis lineata is easier to cultivate than *M. fusca*. Under conditions comparable to those outlined above for *M. fusca*, GIESA (1966) was able to obtain 5 generations of *M. lineata* (generation time 35 days). Even after 2 years, *M. lineata* still exhibited normal vitality. GIESA's paper contains details on copulation, oviposition, embryonic development and other aspects of the life cycle of *M. lineata*.

Otocelis luteola

The acelous turbellarian *Otocelis (Parotocelis) luteola* has been cultivated by KOZLOFF (1969) under monoxenic conditions. Associated bacteria were eliminated by 5 or more transfers (sterile micropipettes) through sterile sea water containing 500 µg of streptomycin sulphate and 400 units of potassium penicillin G ml⁻¹. Each of the sea-water antibiotic baths consisted of approximately 8 to 10 ml of fluid contained in a sterile disposable plastic Petri dish of 60 mm diameter. Washing periods ranged from 6 to 48 hrs.

From the final bath, the worms were transferred into screw-cap culture tubes containing 4 to 10 ml of ES medium (PROVASOLI, 1968) with a pH of 8.0 supporting a light growth of diatoms. Usually, 2 to 4 mature or almost mature *O. luteola* were placed in each tube, as well as members of 12 different diatom species—grown bacteria-free in enriched sea water (ES medium)—tested individually for their capacity to support growth and reproduction of the worms (Table 5-24).

Stock cultures of the diatoms and culture tubes to which worms had been added were kept in diffuse window light at 19° to 21° C. The diatoms had been isolated at various localities on the Pacific and Atlantic coasts of North America and the Atlantic coast of Europe. None of them were eaten by *Otocelis luteola* in its natural habitat; however, close relatives of some of the species have been identified among the habitat diet. When young *O. luteola* hatched from the eggs laid, their development was followed until they could no longer be distinguished from the parental generation. Cultures in which reproduction was recorded and full sexual maturity attained by the progeny were perpetuated by transfer of all or part of the population to other culture tubes, or to 500-ml screw-cap flasks with about 150 ml of medium, or to 1000-ml flasks with about 300 ml of medium. The medium used for these subcultures had generally been previously inoculated with members of the appropriate diatom species, although this was found to be unnecessary if enough diatoms were carried over at the time of worm transfer.

Of the 12 diatoms tested, 8 turned out to be entirely unsuitable. *Navicula incerta* and *Cylindrotheca fusiformis* supported some mature or nearly mature turbellarians for a number of weeks; occasionally, offspring were produced and sometimes attained maturity; however, indefinite growth and reproduction of *Otocelis luteola* did not occur. Only *Navicula pavillardii* and *Nitzschia dissipata* supported long-term growth and reproduction. With either of these diatoms, the turbellarians reached sexual maturity after about 3 weeks. In subculturing, it is best to use tubes or flasks with only slight growth of *Navicula pavillardii* or *Nitzschia*

dissipata, since rapid growth of the diatoms can cause the medium to become critically alkaline (up to pH 9.7); on the other hand, insufficient numbers of diatoms may lead to starvation. KOZLOFF (1969) did not differentiate between nutritional values of diatoms, organic compounds excreted by diatoms, and the medium itself. However, he indicates the possibility that some of the vitamin components of the ES medium may be utilized directly by *O. luteola*.

Encountering a diatom, *Otocelis luteola* examines it by placing the anterior part

Table 5-24

Diatom species tested individually as potential food source for supporting growth and reproduction of the acoelous turbellarian *Otocelis (Parotocelis) luteola*. —: entirely unsuitable; ∓: unsuitable for continuous cultivation; +: suitable for indefinite cultivation (After KOZLOFF, 1969; modified; reproduced by permission of ASP Biological and Medical Press)

Species	Food value
Pennatae	
<i>Achnanthes brevipes</i>	—
<i>Amphiprora paludosa</i> var. <i>duplex</i>	—
<i>Cylindrotheca fusiformis</i>	∓
<i>Navicula incerta</i>	∓
<i>N. pavillardii</i>	+
<i>Nitzschia angularis</i> var. <i>affinis</i>	—
<i>N. brevirostris</i>	—
<i>N. dissipata</i>	+
<i>N. marginata</i>	—
<i>Phaeodactylum tricornutum</i>	—
Centricae	
<i>Melosira nummuloides</i>	—
<i>Thalassiosira fluviatilis</i>	—

of the ventral body surface over it (KOZLOFF, 1972). If accepted, the diatom is pushed through the mouth into the digestive tissue. In selecting diatoms, *O. luteola* seems to recognize the polysaccharides in the cell wall or the mucilaginous material external to the wall. Frustules from which all organic material has been removed are not accepted, but if these frustules are coated with gum arabic or gum tragacanth, they are readily eaten. During digestion, diatoms are circulated through the syncytium. Repeated coalescence of vacuoles originally containing single diatoms leads to the accumulation of several empty frustules in one vacuole, which is moved to an area dorsal or posterodorsal to the mouth. Frustule elimination is effected by bursting the vacuole as the mouth dilates and the body contracts.

(b) Reproductive Biology

Copulatory behaviour of the hermaphroditic *Archaphanostoma agile*, *Pseudaphanostoma psammophilum* and *Convoluta convoluta* is illustrated in Figs 5–10 to 5–12. In *A. agile*, the female copulatory apparatus is reduced to a 'bursal tissue', while the male organ is well developed (DÖRJES, 1968). Sperm is transferred by exactly aimed, mutual injection into the bursal tissue of the partner (APELT, 1969). Oviposition occurs exclusively during the 24 to 48 hrs following copulation. Apparently, only fully matured oocytes are fertilized; they are later oviposited in 1 or 2 egg batches. In the natural habitat, continuous ovipositions are favoured by high, contact-facilitating population densities.

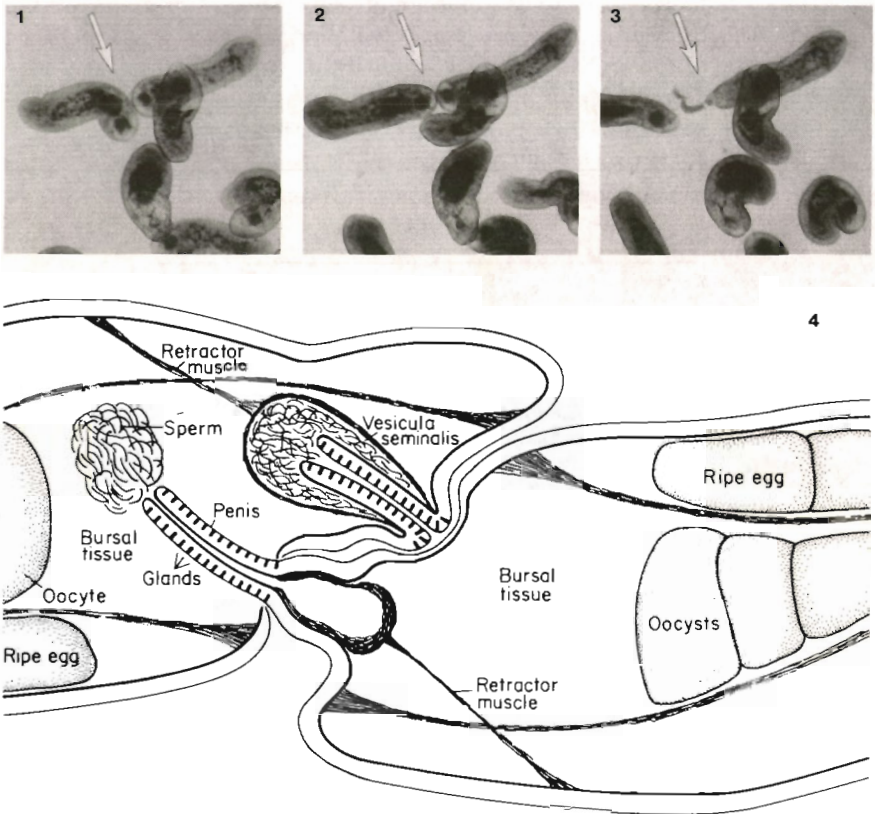

Fig. 5-10: *Archaphanostoma agile*. 1 to 3: Copulation attempt (film-frame sequence). Arrows point to the active pair. 1: Indicating readiness for copulation, the right individual's body end dabs the bent posterior of its partner. 2: The dabbed partner offers its hind part, but withdraws at the last moment, so that the right individual ejaculates its sperm into the water (3). 4: Mutual copulation (see lower diagram). The penis of the right individual has penetrated the body wall of its partner and injects sperm into its bursal tissue. The left individual presses its copulatory organ against its partner; the proximal glands of its protruding penis glue to the foreign epidermis, stretch it and thus facilitate body-wall rupture and penetration. (After APELT, 1969; modified; reproduced by permission of Springer-Verlag, Berlin.)

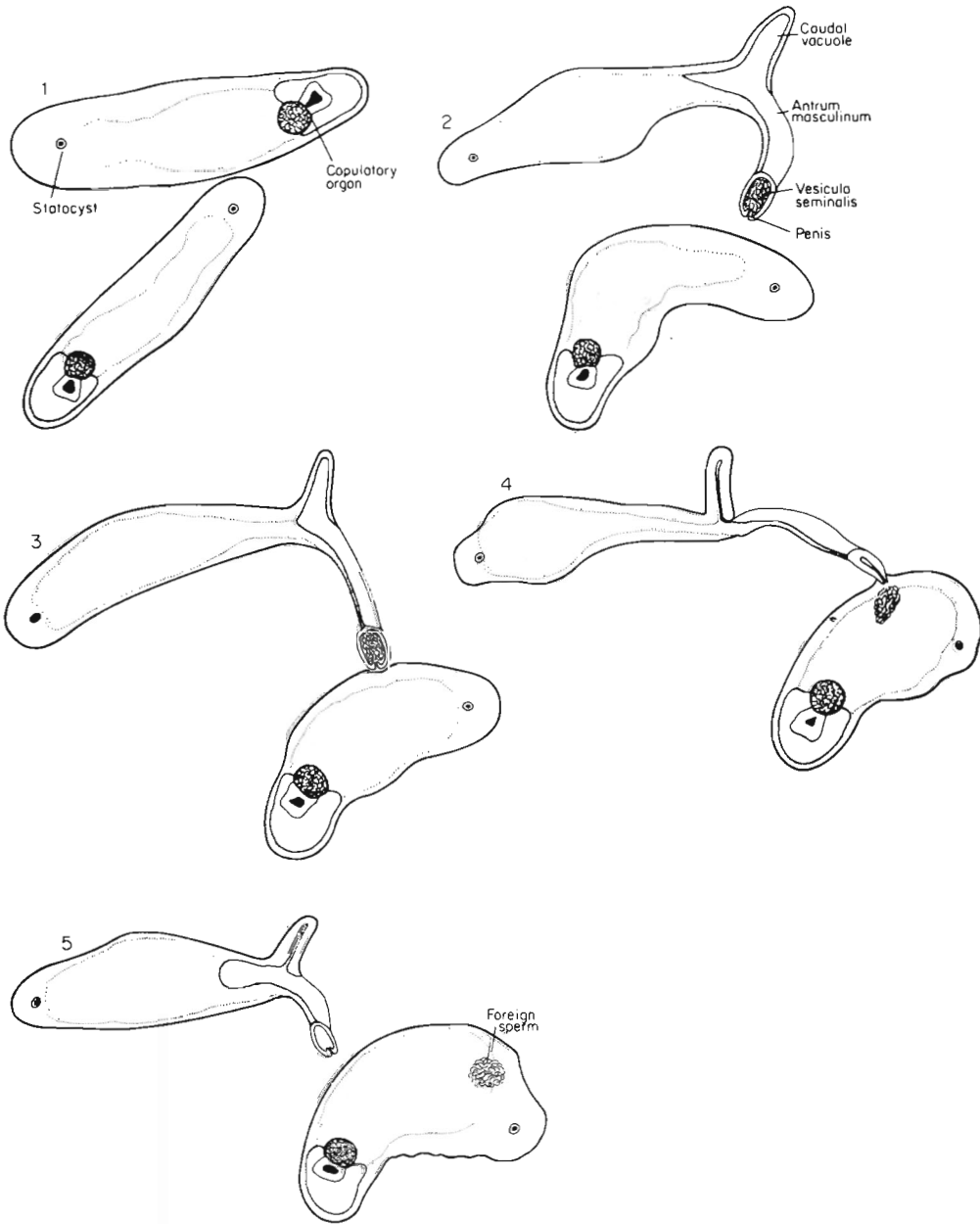

Fig. 5-11: *Pseudaphanostoma psammophilum*. Copulation. 1: Approach; 2: catapulting of copulatory organ; caudal-vacuole contents lend rigidity to the antrum masculinum; 3: tip of copulatory organ glues to partner's epiderm; 4: contraction of vesicula seminalis effects hypodermal sperm injection; 5: retraction of copulatory organ. (After APELT, 1969; modified; reproduced by permission of Springer-Verlag, Berlin.)

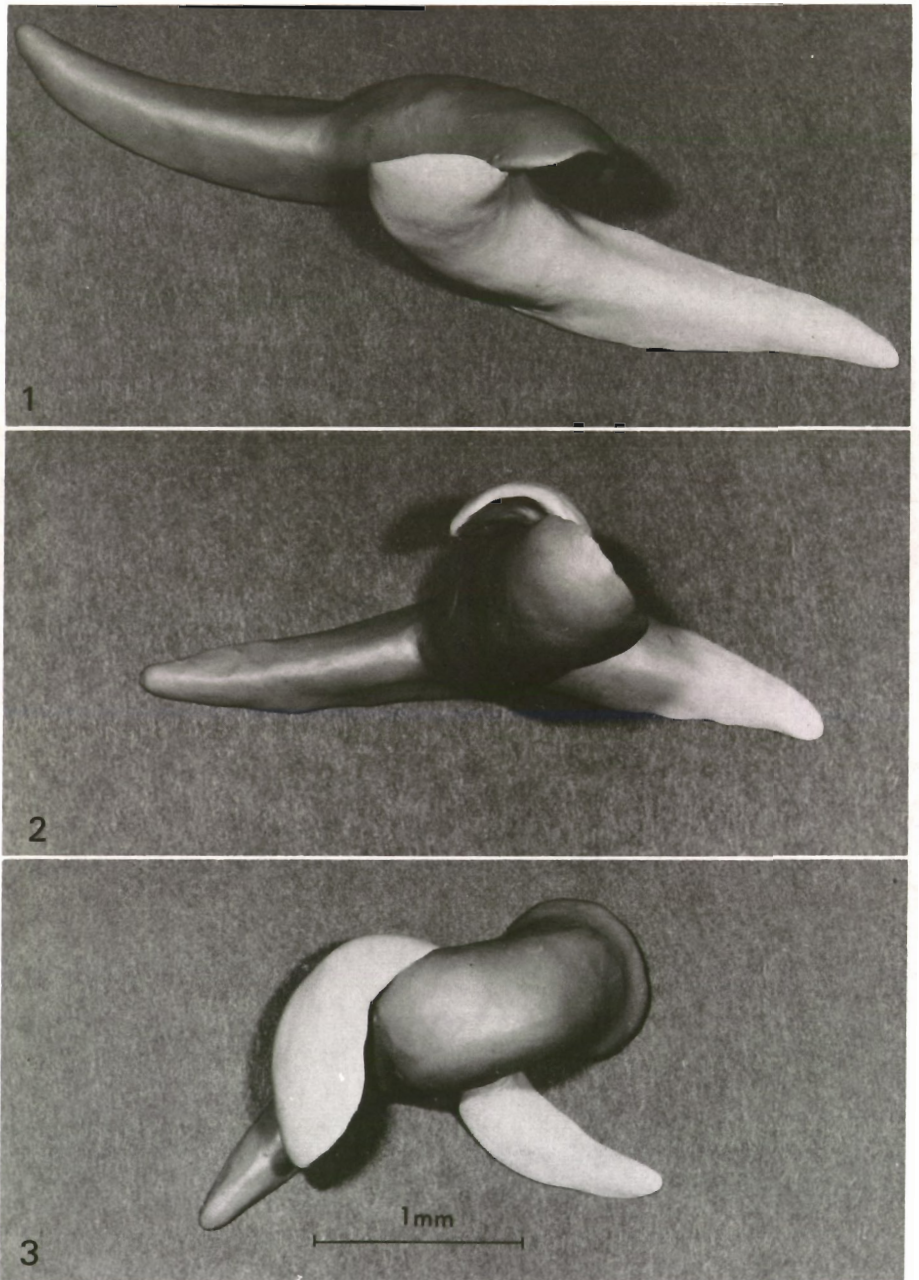

Fig. 5-12: *Convoluta convoluta*. Copulation (model). 1: Encounter; 2: mutual erection of anterior body parts; 3: cross-hooked, both partners pump sperm into each others' bursa seminalis. (After APELT, 1969; reproduced by permission of Springer-Verlag, Berlin.)

Pseudaphanostoma psammophilum features secondarily modified copulatory organs; APELT (1969) considers its reproductive biology to be specifically adjusted to life in the mesopsammal; copulation lasts about 0.3 secs; it is a unilateral, unaimed hypodermal injection. Apparently, also immature oocytes are inseminated: individuals isolated immediately after copulation laid up to 15 eggs over a period of 2 to 3 weeks.

Archaphanostoma agile and *Pseudaphanostoma psammophilum* are capable of producing eggs continuously. Oviposition is associated with a rupture in the body wall. Following copulation, *A. agile* produces 1 to 7 eggs in a single mass; *P. psammophilum*, up to 15 single eggs over a period of up to 20 days. In general, *Convoluta convoluta* lays 20 to 30 eggs at intervals of more than 14 days.

Table 5-25

Reproductive potentials of cultured acoelous turbellarians. Average values. 15° to 18° C; 32‰S (Based on information presented by APELT, 1969, and APELT, personal communication)

Species	No. of eggs laid within 10 days	Duration of embryogenesis (days)	Generation time (days)	Maximum age (days)
<i>Archaphanostoma agile</i>	11-12	2-4	18-22	more than 570
<i>Pseudaphanostoma psammophilum</i>	7-8	2-5	30-55	82-175
<i>Pseudohaplogonaria vacua</i>	10 eggs within 200 days	9-15	more than 70	more than 273
<i>Bursosaphia baltalimaniaformis</i>	30-42	2-4	16-22	98-118
<i>Otocelis rubropunctata</i>	ca 17	2-4	ca 18	ca 120
<i>Otocelis westbladi</i>	ca 16	2-4	ca 22	ca 185

APELT (personal communication) also studied the reproductive biology of *Bursosaphia baltalimaniaformis*. Hermaphrodites as most turbellarians, *B. baltalimaniaformis* perform unilateral copulations about as often (~50%) as bilateral (mutual) copulations. This high percentage of unilateral copulations may, however, be an artifact due to interfering influences caused by observation procedures. APELT expects mutual copulation to be the rule under habitat conditions.

The reproductive potentials of turbellarians cultivated by APELT (1969)—amended by new results (APELT, personal communication)—are listed in Table 5-25. The upper lethal temperature for cultured *Archaphanostoma agile* is 25° to 26° C; egg production is markedly lower at 22° C than at 16° to 18° C; surprisingly, at 5° to 6° C and 16° to 18° C, propagation rate is nearly the same, provided *A. agile* has been allowed to acclimate to the low temperature level (see also Volume I: KINNE, 1970, pp. 493, 496). Egg production is significantly reduced at 3° to 4° C, and ceases at -1° to 1° C.

(c) Turbellaria as Assay and Food Organisms

The use of turbellarians as assay organisms is a virgin field. Forms such as *Archaphanostoma agile* can be cultivated easily, and should lend themselves for purposes of bioassay.

APELT (personal communication) used cultures of *Bursosaphia baltalimaniaformis* for assessing effects of $\text{Fe}(\text{OH})_3$ pollutants introduced into the southern North Sea. It turned out that *B. baltalimaniaformis* developed well in the presence of $\text{Fe}(\text{OH})_3$. APELT even recommends the use of precipitated $\text{Fe}(\text{OH})_3$ as substratum for cultivating soft-bottom animals. This chemically defined substratum can be produced bacteria-free, and resolved easily after transfer of the cultivated individuals, facilitating offspring counting.

No information is available on the role of marine turbellarians as food organisms for other cultured animals.

(d) Turbellaria: Conclusions

Not a classical object for cultivation studies, marine Turbellaria have recently been kept successfully under controlled laboratory conditions. Representatives of several littoral species have been cultured through numerous generations and are now available for ecological experimentation.

Diatoms, ciliates, crustacean nauplii, flesh of oligochaetes, polychaetes, molluscs, crustaceans and fishes, as well as members of their own group, served as food sources. Symbiont carriers, such as *Convoluta roscoffensis*, require illumination (e.g. 300 ft. c.; 14-hr day) and enriched sea-water media.

Symbiont carriers provide examples of specialized and very close organism-organism relationships. Only if essential portions of the natural turbellarian-symbiotic alga connex are reconstituted under the conditions provided, can there be hope for successful long-term cultivation. Adequate light and temperature conditions as well as proper quantitative relations between turbellarians and symbionts seem essential.

The species cultured have revealed interesting details of their reproductive biology. The diversity and specificity of reproductive functions and structures indicate intimate correlations to the respective biotopes inhabited. Life-cycle studies on cultured turbellarians may be expected to yield information of considerable interest both to ecologists and evolutionists.

The importance of cultivated turbellarians as assay organisms and as food source for other cultured animals remains to be investigated. The ease with which species such as *Archaphanostoma agile* can be bred under controlled conditions should encourage further research along these lines.

(6) Rotifera

Our present knowledge on rotifer cultivation is based, to a large extent, on limnic representatives. In the hope of stimulating comparable research on marine forms, and assuming that the know-how available on freshwater rotifers can assist the

marine ecologist, we have included here some essential papers devoted to the culture of freshwater Rotifera.

The first biologists to engage in the cultivation of Rotifera were MAUPAS (1891), NUSSBAUM (1897), WHITNEY, (1907, 1914a, b, 1915, 1916, 1917, 1919, 1929), MITCHELL (1913), NOYES (1922), LUNTZ (1926, 1929), MILLER (1931), DE BEAUCHAMP (1928, 1938) and BUCHNER (1936, 1938, 1941a, b). Early reviews related to rotifer cultivation have been provided by SHULL (1929) and HYMAN (1951). A review including much of what has been done in culturing freshwater rotifers in Japan has been published by ADACHI (1966). Most early investigators paid special attention to the modes of rotifer reproduction.

(a) Major Species Cultivated

Brachionus plicatilis

Methods for mass-cultivating *Brachionus plicatilis* have been developed especially in Japan, e.g. by HIRATA and MORI (1967), MORI and HIRATA (1968), FURUKAWA and HIDAKA (1972), HIRAYAMA and KUSANO (1972) and HIRAYAMA and OGAWA (1972). HIRATA (1974) used round polycarbonate tanks of 30-l capacity, containing ca 10 l of crushed gravel as inside bottom filter (essentially similar to the arrangement shown in Fig. 2-61, p. 115). He inoculated the culture water at the beginning with KNO_3 (6.0 g), KH_2PO_4 (0.6 g), Clewat-32 (0.9 g), Clewat-Ca (0.1 g) and introduced a 'marine type *Chlorella*'. As soon as the *Chlorella* population attained the stationary phase, 'a small number' of *B. plicatilis* were added. After most of the *Chlorella* had been consumed by the rotifers, HIRATA offered frozen marine yeast. The yeast was supplied in 6-hr intervals at cell concentrations ranging from 100×10^4 to $2000 \times 10^4 \text{ ml}^{-1}$. The maximum rotifer population densities obtained in 3 experiments were 1450, 1170 and 1270 individuals ml^{-1} . Maximum rotifer population-growth was obtained at 27.6° C.

The importance of the euryhaline rotifer *Brachionus plicatilis* as food for larvae and juveniles of marine fishes (see VASIL'eva and OKUNEVA, 1961, and p. 688) prompted also THEILACKER and McMASTER (1971) to investigate requirements for mass cultivation. They point out that in any culture procedure where maximum yield is desired, amictic (parthenogenetic) reproduction must be optimized and conditions avoided which favour mictic (sexual) reproduction leading to smaller males and resting eggs. High food concentrations turned out to be the most important factor for producing maximum rotifer yields (Tables 5-26 and 5-27). Maximum reproduction occurs between 30° and 34° C; however, since the food algae do not tolerate such high temperatures, all experiments were performed between 21° and 25° C. At 24° C, doubling times ranged from 0.8 to 2.9 days. No obvious differences in reproductive rates were observed between rotifers fed on different algal diets. THEILACKER and McMASTER used *Dunaliella* sp. as the main diet to determine the relationship between doubling time and algal densities. With a 10-fold increase in algal density, doubling times shortened from almost 3 days to about 1 day. Reproduction rate was the same in 25‰ and in 33‰ S. No decrease in doubling times was noted with increasing rotifer population density. Crowding up to 200 rotifers ml^{-1} does not seem to inhibit reproduction.

Table 5-26
Brachionus plicatilis. Reproductive rates of rotifers fed on 4 algal diets. 24 ° C; 33‰S (After THEILACKER and McMASTER, 1971; reproduced by permission of Springer-Verlag)

Diet	Cell concentration (No ml ⁻¹)	Initial number of rotifers (N ₀)	Final number of rotifers (N _t)	Time in days (t)	Instantaneous growth rate (K)	Doubling time (days)	Final concentration of rotifers (No ml ⁻¹)	Container size (ml)
<i>Monochrysis lutheri</i>	3 × 10 ⁶	10	36 × 10 ³	12	0.68	1.0	18	2000
		10	130	4	0.64	1.1	1	100
		2000	42 × 10 ³	4	0.76	0.9	200	2000
<i>Nannochloris</i> sp.	4 × 10 ⁶	10	16 × 10 ³	12	0.62	1.1	8	2000
		10	270	4	0.82	0.8	3	100
<i>Ereviella</i> sp.	6 × 10 ⁶	2000	30 × 10 ³	4	0.68	1.0	152	2000
		10	190	4	0.74	0.9	2	100
<i>Dunaliella</i> sp.	1 × 10 ⁶	35	12 × 10 ⁴	17	0.61	1.1	60	2000
		10	54 × 10 ³	13	0.66	1.1	27	2000
		10	230	4	0.78	0.9	2	100
		2000	45 × 10 ³	4	0.78	0.9	220	2000

Table 5-27
Brachionus plicatilis. Reproductive rates of rotifers fed on several concentrations of *Dunaliella* sp. 24° C; 33‰S (After THEILACKER and McMASTER, 1971; reproduced by permission of Springer-Verlag)

Diet	Cell concentration (No ml ⁻¹)	Initial number of rotifers (N ₀)	Final number of rotifers (N _t)	Time in days (t)	Instantaneous growth rate (K)	Doubling time (days)	Final concentration of rotifers (No ml ⁻¹)	Container size (ml)
<i>Dunaliella</i> sp.	1 × 10 ⁵	80	900	10	0.24	2.9	0.5	2 000
	1 × 10 ⁵	80	850	8	0.30	2.3	0.4	2 000
	1 × 10 ⁵	7	90	10	0.26	2.7	0.9	100
	2 × 10 ⁵	20	3 × 10 ⁴	20	0.37	1.9	15	2000
	2 × 10 ⁵	20	6 × 10 ⁴	20	0.40	1.8	30	2000
	1 × 10 ⁵ *	100	93 × 10 ³	9	0.76	0.9	46	2000

* See Table 5-26 for additional data.

Mass cultures of *Brachionus plicatilis* were established by THEILACKER and MCMASTER (1971) in fibre-glass water tables (LASKER and VLYMEN, 1969), filled to a depth of 13 cm (464 l) with *Dunaliella* medium and inoculated with 32 l of a *Dunaliella* culture (final concentration: 2×10^5 cells ml⁻¹). The water-table cultures were aerated and kept under constant illumination (140 to 170 ft. c.). *B. plicatilis* were added when the *Dunaliella* population reached 1×10^6 cells ml⁻¹ (usually in 2 to 4 days). An inoculum of 2×10^4 rotifers yielded 2.5×10^6 *B. plicatilis* day⁻¹ after 4 or 5 days. The rotifers were harvested daily for about 1 month; as the algae were consumed more quickly than they reproduced, *Dunaliella* culture had to be added as necessary. The rotifers were harvested by slowly circulating the culture water with a submersible pump. They were forced down a plastic tube, the end of

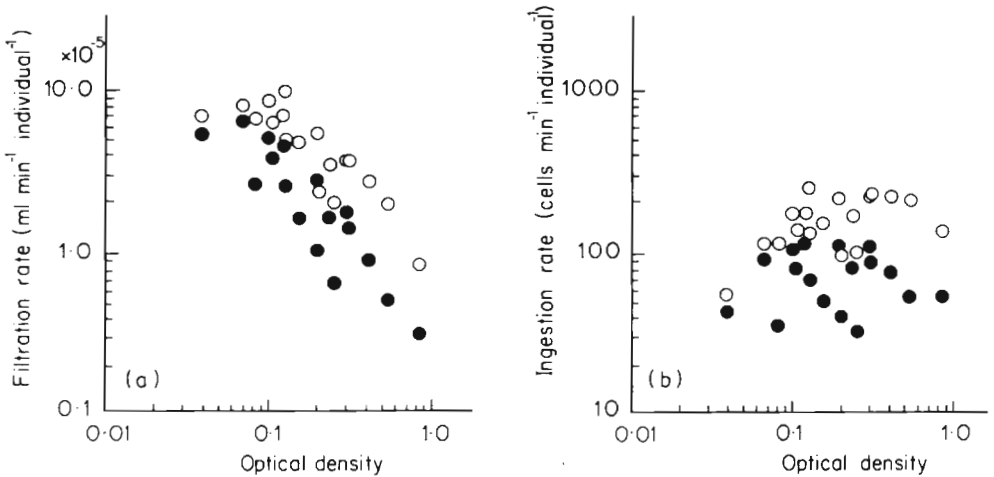

Fig. 5-13: *Brachionus plicatilis*. (a) Filtration rate; (b) ingestion rate. Food: a marine *Chorella* species. 25° C; 13.5‰ chlorinity; 7.4 to 7.6 pH. An optical density of 0.1 represents about 200 *Chlorella* sp. cells ml⁻¹, an optical density of 0.5, about 1000 cells ml⁻¹. Filled circles: rotifers with full stomachs; open circles: rotifers with empty stomachs. (After HIRAYAMA and OGAWA, 1972; modified; reproduced by permission of the authors.)

which was covered with 64- μ m Nitex mesh netting. The average calorific content of *B. plicatilis* is 5335 cal g⁻¹ dry weight organic substance.

Stock cultures of *Brachionus plicatilis* could be maintained for months by THEILACKER and MCMASTER (1971) at 13° to 17° C in a 500-l holding tank, provided the rotifers were fed *Nannochloris* sp. at a minimum concentration of 1×10^6 cells ml⁻¹. Addition of nutrients, 200 ft. c. illumination for 14 hrs day⁻¹ and aeration were required. At 13° to 17° C, *B. plicatilis* reproduces slowly, maintaining a constant population density.

HIRAYAMA and associates cultivated *Brachionus plicatilis* in Miquel sea water (no details given). They examined filtration rates (HIRAYAMA and OGAWA, 1972), temperature effects (HIRAYAMA and KUSANO, 1972), influence of phytoplankton density on population growth (HIRAYAMA and co-authors, 1973), and the nutritional value of yeast (HIRAYAMA and WATANABE, 1973). Amictic females received *Chlorella* sp. from a marine habitat as food. At 25° C, about 12.5‰ chlorinity, pH values

between 7.4 and 7.6, and food densities of less than 213×10^4 cells ml^{-1} , *B. plicatilis* maintained maximum filtration rates of about $(7 \text{ to } 10) \times 10^{-5}$ (empty-stomach individuals) and $(5 \text{ to } 7) \times 10^{-5}$ (full-stomach individuals) per minute per individual, while the ingestion rate tended to increase (Fig. 5-13). At higher food densities, the filtration rate decreased, while the ingestion rate tended to remain constant (about 200 cells min^{-1} individual $^{-1}$ in empty-stomach individuals). Fecundity as a function of temperature is illustrated in Fig. 5-14.

According to HIRAYAMA and KUSANO (1972), the physiological activity of *Brachionus plicatilis* is affected by the culture conditions experienced by its parents and during its egg development. This interesting finding parallels a previously

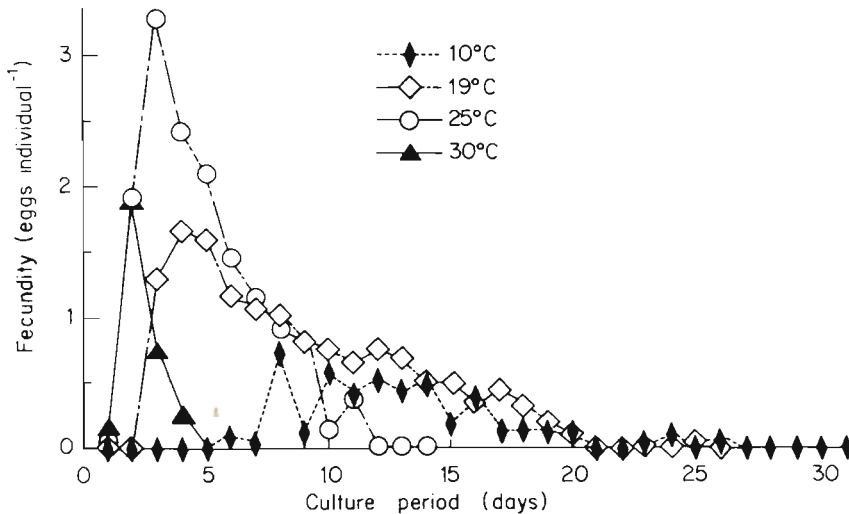

Fig. 5-14: *Brachionus plicatilis*. Fecundity of populations cultivated at different constant temperatures. 25° C is assumed to be optimal for mass production. (After HIRAYAMA and KUSANO, 1972; reproduced by permission of the authors.)

reported case of irreversible non-genetic adaptation in a cultured cyprinodont fish (KINNE, 1962).

A food density of 85 to 213×10^4 cells ml^{-1} is desirable for maximum yield of cultured *Brachionus plicatilis*. Presumably, a concentration of 150×10^4 cells ml^{-1} is optimal for maximum rotifer population increase (HIRAYAMA and co-authors, 1973). Yeast is less efficient as nutrient for *B. plicatilis* than *Chlorella* sp. However, added to a diluted *Chlorella* suspension, marine yeast is very effective as a supplementary food source (HIRAYAMA and WATANABE, 1973). Attempts to sustain *B. plicatilis* on dry-food diets have not yet produced convincing results.

THEILACKER and MCMASTER on the one hand and HIRAYAMA and his associates on the other have used different food organisms. Hence, the results of these important investigations are not strictly comparable. In addition, it is deplorable that the taxonomic identity of the food algae has been determined only to the genus in all cases.

Chemostat cultures of *Brachionus plicatilis* have been quite successful, especially when combined with a food-alga chemostat (DROOP, 1966a; DROOP *in*: CONOVER, 1970). With the culture medium flowing in and out at a defined rate, *B. plicatilis* grows as fast as the continuously provided nutrient concentration will permit. For details on chemostats, consult Chapter 2, p. 212. The development of suitable chemostat cultures often requires patience:

'I started with the conventional sort of set-up and then simplified, simplified and simplified; so a lot of the snags have been worked out . . . You can spend months and months tinkering around if the organism is unfamiliar. Suddenly everything is right and you get masses and masses of information . . .' (DROOP *in*: CONOVER, 1970, p. 409).

A number of environmental factors have been shown to affect the ratio of mictic versus amictic females in *Brachionus plicatilis* and related forms: temperature (EDMONDSON, 1965), salinity (ITO, 1960), population density (GILBERT, 1963), nutrition (EDMONDSON, 1965). However, a definite picture of the physiological mechanism(s) involved has not yet emerged.

Colurella colurus and *Keratella cruciformis*

Several rotifers represent important faunistic elements of the Baltic Sea, both in terms of species number and biomass (e.g. SCHWARZ, 1963). For this reason, SPITTLER (1969) has attempted to cultivate representatives of the 2 species *Colurella colurus* and *Keratella cruciformis* var. *eichwaldi*.

The rotifers were collected with fine pipettes from net-plankton samples, and portions of 20 individuals each accommodated in individual culture containers ('Esmarch' dishes containing 25 or 50 ml culture medium). The cultures were maintained at 17° to 22° C near a window, but protected from direct sunlight. The culture medium consisted of: 19 parts filtered (G5 paper filter) habitat water and 1 part earth extract adjusted to pH 7.6 (see also BUCHNER, 1941a, b). Attempts to replace the earth extract by N₂EDTA (10⁻⁴M; NEUNES and PONGOLINI, 1965) or to use habitat water without additions failed. *Chlorella pyrenoidosa* were added as food source to the rotifer cultures in a final concentration of ca 2 × 10⁵ cells ml⁻¹. Initially, SPITTLER fed his cultures at 3, later at 6-day intervals.

SPITTLER (1969) kept *Colurella colurus* in 11‰S. Raw cultures thrived on 1 wheat grain per 0.50 ml culture medium without additional food. In 7‰ to 8‰S, *Keratella cruciformis* var. *eichwaldi* was sustained for 8 months. Dwarf males were seen only rarely, mostly in newly separated cultures. Both rotifers consume detritus.

Limnic Representatives

Brachionus urceolaris, *B. pala*, *B. angularis*, *B. bakeri*, *Notops branchionus*, *Anuraea aculeata* and *Pterodina patina* have been cultivated by BUCHNER (1941b). He used chemically undefined media, based on an extract, prepared from air-dried earth and passed through a sieve. The sieved portion was combined with an equal-weight unit of distilled water, and the resulting mixture boiled for 1 hr. BUCHNER allowed the suspension obtained to settle for 2 to 3 days; the still turbid water was

then filtered and again allowed to settle until the solution had completely cleared. This clear solution was used, at various dilution levels (addition of glass-distilled water), as culture medium. The rotifers were offered members of an undetermined *Chlorella* species as food source.

Population density affects the mode of reproduction (BUCHNER, 1941b): low density tends to induce parthenogenesis; high density, bisexuality and sexual reproduction. Bisexuality decreased progressively with increasing age of the culture medium. Transfer into fresh medium caused an augmentation in the percentage of mictic females. Apparently, bisexuality and vitality are causally interrelated. These results contradict LUNTZ (1926, 1929), who obtained parthenogenesis under constant culture conditions, and who induced bisexuality through quantitative or qualitative changes in nutrition (see also GILBERT, 1968), pH or salt content. Critical assessment of our present knowledge regarding the factors which induce sexual reproduction in rotifers (BIRKY and GILBERT, 1971; BUCHNER, 1971; GILBERT, 1971; HALBACH and HALBACH-KEUP, 1972) demonstrates that the information at hand is still insufficient for postulating definite correlations.

For cultivating rotifers of the genera *Monostyla*, *Lecane* and *Philodina*, KWASIK-PUI (1960) employed the following method: Pasteurize 1000 cm³ of pond water and buffer at pH 7.4. Pour 200 cm³ into each of five 250-cm³ culture bowls containing 10 previously boiled wheat grains of 2.5-cm alfalfa haystems. Allow to cool and inoculate with 1 cm³ of *Euglena* sp. culture as food. After cultures have grown for 1 week at 30° C in moderate light, inoculate with 10 cm³ of concentrated *Philodina*, *Lecane* or *Monostyla* culture. Allow 2 weeks for maximum growth before using for classroom study or experimentation. Subcultures may be made after 4 weeks (see also ADACHI, 1964a, b).

DOUGHERTY and co-authors (1960a, 1961a), DOUGHERTY (1964) and HARRIS and DOUGHERTY (1964) cultivated the antarctic viviparous bdelloid rotifer *Philodina gregaria*. After offering 'algal tea' (sterilized infusion with 0.05% Na₂HPO₄ and CaCO₃ added to saturation) and a fragment of filamentous algal film, HARRIS and DOUGHERTY attempted elimination of the algal components. They used 'lettuce tea' (10 g Romanian lettuce with 0.5 g K₂HPO₄ and 0.5 g CaCO₃ in 1 l of distilled water, diluted with equal volumes of distilled water). Without algal fragments, both algal infusion and algal tea proved to be unsatisfactory; the reproduction rate declined after the first generation. Lettuce tea without algae yielded better results, even though *P. gregaria* became pigmented light brown instead of red. Limited monoxenic culture was realized with *Escherichia coli* as food source, and dixenic cultures in algal tea (with *E. coli* plus an unidentified bacterium) were successful (HARRIS and DOUGHERTY, 1964). For details concerning axenization procedures consult DOUGHERTY (1960) and Chapter 5.11 (see also DOUGHERTY, 1959, and WHITELOCK, 1959).

Another rotifer cultivated by DOUGHERTY and associates, the minute monogonont *Lecane inermis*, was recovered from a sample of a gastrotrich (*Lepidodermella squamata*). Success in axenic cultivation of *L. inermis* (DOUGHERTY and co-authors, 1961b) and subsequent failure to maintain the axenic line in its 5th serial set of cultures after 5 months (DOUGHERTY, 1963) was followed by reestablishment of axenic cultures (DOUGHERTY and HARRIS, 1964). The new medium used was completely heat sterilized and consisted of 3 components: (i) Oxoid liver infusion;

(ii) a mixture of known vitamins, salts, etc. (no details given) plus casein protein; (iii) algal tea of antarctic algae. The concentration of liver infusion proved critical; *L. inermis* grows well at 0.5%, but poorly at 0.01% and at 0.1%. Peptone is an essential addition to the defined mix; *L. inermis* does not multiply significantly when amino acids are used instead. A suitable replacement for algal tea has not yet been found. Xenic cultures of *L. inermis* have been sustained successfully by MILLER (1931). She reports the presence of mictic eggs and males which did not occur in the monoxenic and axenic cultures of DOUGHERTY and associates. *L. inermis* differs from two other monoxenically grown, bacteriophagous rotifers—the bdelloids *Philodina acuticornis* var. *odiosa* (DOUGHERTY and co-authors, 1960b) and *Habrotrocha constricta* (HARRIS in: DOUGHERTY, 1963)—in that the latter two species grow well with *Escherichia coli* as food source. *H. constricta* thrives in malted milk solution with *E. coli* even in the absence of any heated liver-extract supplement. These observations indicate that the rotifers mentioned differ in their ability to use a given bacteria species as food in monoxenic culture (DOUGHERTY, 1963).

The algivorous rotifer *Epiphanes (Hydatina) senta* has been maintained in culture by WHITNEY (1929) and BAZIRE (1953). BAZIRE bred *E. senta* monoxenically in sustained culture. She used *Euglena gracilis* or *Polytomella caeca* as food organism in a non-defined medium containing mineral salts, peptone and undisclosed growth-promoting substances. The medium was dispensed into sterilized tubes inoculated with the food organisms mentioned. *E. senta* was introduced to the tubes after the flagellates had developed dense populations. The cultures could be sustained for periods of up to 138 days (food: *P. caeca*). They were tested periodically for the presence of contaminating micro-organisms by inoculating culture medium into nutrient agar, Sabouraud agar, Martin broth or 'gelose Veillon en culot'.

Brachionus variabilis was cultivated monoxenically in concave wells, enclosed in Petri dishes and containing Seitz-filtered pond water (NATHAN and LADERMAN, 1959). The rotifer received *Chlorella* sp. or an unidentified bacterium as food source. These cultures lasted 3 generations. Dixenic culture with both *Chlorella* and the bacterium could be sustained for more than 2 months. For axenization, embryos were hatched in media containing antibiotics; or newly hatched *B. variabilis* received antibiotic treatment; resting eggs were axenized by 1-min washing in 0.005 to 0.01% hypochlorite. Antibiotics and hypochlorite were later removed by serial transfer of embryos or resting eggs through wash liquids, and aliquots of the last wash liquid were tested for contaminants in peptone-glucose broth. DOUGHERTY and SOLBERG (1959)—employing techniques similar to those of NATHAN and LADERMAN (1959)—reported long-term dixenic cultivation of *B. variabilis* with *C. pyrenoidosa* and an unidentified bacterium in Seitz-filtered pond water. Addition of yeast-extract traces and vitamin B₁₂ yielded limited monoxenic cultivation with *C. pyrenoidosa*, but subcultures did not develop.

POURRIOT (1965a, b) established and sustained monoxenic cultures of *Brachionus urceolaris sericus* and *B. rubens* with *Chlorella pyrenoidosa*, grown axenically on a mineral medium and then concentrated (decantation, centrifugation) before being fed to the rotifers. He axenized his rotifers by treating resting eggs in hypochlorite and exposing them to subsequent washings. Contamination tests were performed in peptone and Sabouraud media. The culture medium was a 4-fold dilution of the major salt components of the *C. pyrenoidosa* medium to which 10% soil extract was

added in the case of *B. rubens*. The *B. rubens* cultures were terminated after 3 months; *B. urceolaris sericus* was still thriving after 1 year.

Indefinite monoxenic cultures of the limnic *Brachionus calyciflorus* var. *pala* (from a farm pond) with axenic *Euglena gracilis*, employing the same defined buffered medium for both organisms, have been achieved by GILBERT (1970; see also 1963). The components of the medium are listed in Table 5-28. GILBERT used double-distilled water for all solutions. Stock solutions of each of the 7 major salts were made 100 times the final concentration and stored at room temperature. One

Table 5-28

Composition of culture medium for the limnic rotifer *Brachionus calyciflorus* var. *pala*. (After GILBERT, 1970; reproduced by permission of Springer-Verlag)

Compound	Final concentration (mg ml ⁻¹)
Major salts	
(NH ₄) ₂ HPO ₄	333.00
KH ₂ PO ₄	333.00
MgSO ₄ · 7H ₂ O	178.00
Ca(NO ₃) ₂ · 4H ₂ O	96.00
KNO ₃	66.70
K ₂ HPO ₄	26.70
CaCl ₂ · 2H ₂ O	8.90
Trace elements and chelating agent	
FeSO ₄ · 7H ₂ O	2.11
MnCl ₂ · 4H ₂ O	0.91
CoSO ₄ · 7H ₂ O	0.75
ZnSO ₄ · 7H ₂ O	0.23
Na ₂ MoO ₄ · 2H ₂ O	0.12
CuSO ₄ · 5H ₂ O	0.01
Na ₃ C ₆ H ₅ O ₇ · 2H ₂ O	400.00
THAM* buffer (pH 7.5)	
C ₄ H ₁₁ NO ₃	1211.40 (0.01M)
Vitamins	
B ₁	1.0
B ₁₂	5.0 × 10 ⁻³

* THAM = tris(hydroxymethyl)aminomethane

stock solution containing all the trace elements and the sodium-citrate chelating agent was prepared 100 times the final concentration, and about 15 ml of this solution were dispensed into each of a number of screw-cap test tubes (150 × 16 mm) which were autoclaved and stored at 5° C. The buffer was prepared 100 times the final concentration by making a 1.0 M solution of THAM, adjusted to pH 7.5 with concentrated HCl and stored at 5° C. A stock solution of vitamins B₁ and B₁₂ (1000 times the final concentration) was made by adding 0.25 ml of a 0.5 mg ml⁻¹ solution of vitamin B₁₂ to 25 ml of a 1.0 mg ml⁻¹ solution of vitamin B₁. The solutions were sterile filtered into autoclaved screw-cap test tubes (75 × 16 mm) inside an ultra-violet hood and stored at 5° C.

Embryos of *Brachionus calyciflorus* to be axenized were obtained by removing attached eggs from amictic (female-producing) females, which oviposit large, diploid eggs. The females were placed in a well of a Pyrex spot test plate containing about 0.5 ml culture medium. The embryos were then pulled off with a micropipette. Older embryos seemed to have a greater survival chance than younger ones. GILBERT (1970) axenized the eggs by serial transfer through the 9 wells of a sterile spot test plate, each of which contained about 1 ml sterile culture medium; the plate was then placed inside an ultra-violet hood. In a second sterile spot test plate, the first well was filled with 1 ml of 0.025% NaOCl (sterilized and filtered). The remaining 8 wells received sterile culture medium. Eggs were left in the first well for 2 mins, then transferred through each of the 8 washes. Subsequently, they were inoculated in groups of 2 or 3 into sterile screw-cap test tubes (75 × 16 mm) containing 4 to 5 ml of axenic *Euglena gracilis* culture. Monoxenic rotifer cultures were established as soon as the embryos hatched, and sustained upright at 25° C without agitation. They remained in good condition in these tube cultures for about 2 weeks—usually long after the euglenae had been exhausted. In normal procedure, however, subcultures were made once a week. In a typical 5-ml culture, initiated with several individuals, *B. calyciflorus* attained a population density of 93 rotifers ml⁻¹ after 6 days. The monoxenic cultures appeared to be able to persist indefinitely. After 5 months (13 subcultures, 9 contamination tests), they became contaminated. The clone was reaxenized, and remained contaminant-free for at least 8 months (30 subcultures, 18 contamination tests). Generation time was roughly 1 day.

Mictic (male-producing) females of *Brachionus calyciflorus*, which produced small haploid eggs, appeared in the monoxenic cultures when the population densities became high. Actively swimming males were common at this time, and fertilization occurred frequently (presence of thick-walled resting or dormant eggs). Thus all life-cycle stages known to exist in the field occurred in these cultures. However, no observations were made on the ability of the resting eggs to hatch.

According to ADACHI (1966), most limnic rotifers accept as food species of *Anabaena*, *Ankistrodesmus*, *Chlamydomonas*, *Chlorella*, *Dunaliella*, *Eudorina*, *Haematococcus*, *Palmella*, *Polytoma*, *Scenedesmus* and *Selenastrum*, but not the larger-sized forms (e.g. *Coelastrum* sp., *Pandorina* sp.). Large rotifers will also eat *Paramecium* sp. Bacteria can substitute for the above-mentioned food organisms. For promoting bacterial growth, a variety of organic substances have been added to the culture media. A given rotifer often exhibits a preference for a given bacterium or for a few bacteria species. Mass cultures of rotifers can be established in darkness using pure bacteria populations as food. In cultures fed phytoplankton, ADACHI recommends dim light (too much light seems to inhibit rotifer growth).

(b) Rotifera as Assay and Food Organisms

No information has come to the reviewer's attention regarding the use of marine rotifers as assay organisms. This is surprising since small size, short generation time and handy mass-culture methods convey to these interesting animals important prerequisites.

Rotifers such as *Brachionus plicatilis* and *B. rubens* represent excellent food organisms for a variety of cultured aquatic invertebrates and fishes. Developing life-

cycle stages and adults provide a good range of prey sizes for numerous plankton feeders; they can be taken up and digested easily. *B. plicatilis* has been used by Japanese, American and European biologists as food source for juvenile stages of commercially important fishes. In Japan, this rotifer serves as second food source for fry of the yellow-tail *Seriola quinqueradiata* (first food source: larvae of oyster or sea urchin) and for larvae and fry of other marine fishes. HIRAYAMA and OGAWA (1972), HIRAYAMA and KUSANO (1972), FURUKAWA and HIDAKA (1973), HIRAYAMA and co-authors (1973) and HIRAYAMA and WATANABE (1973) investigated basic aspects of mass-culturing *B. plicatilis* (p. 682). The American investigators THEILACKER and McMASTER (1971) found *B. plicatilis* to be a nutritious food for larvae of *Engraulis mordax* (see also p. 980), when fed at concentrations of 10 to 20 individuals ml⁻¹ and in combination with the dinoflagellate *Gymnodinium splendens* (100 ml⁻¹). SULKIN and EPIFANIO (1975) obtained encouraging results with *B. plicatilis* as food source for the first two zoeal stages of the blue crab *Callinectes sapidus*.

In contrast to the authors mentioned above, USUI (1974) warns that *Brachionus plicatilis* is one of the most dangerous zooplankters occurring in eel ponds (p. 64). He holds these rotifers responsible for using up much of the oxygen available and thus causing mass asphyxiation of eels. In addition, *B. plicatilis* consumes phytoplankton which is important for maintaining sufficient water quality in intensive eel-culture ponds. USUI says when a microscopic inspection of a pond-water sample reveals more than 3 rotifers in the view field, the cultivator has no option but to completely renew the pond water as quickly as possible.

(c) Rotifera: Conclusions

The majority of Rotifera kept in culture thus far are limnic. Although marine and brackish water representatives may exhibit comparable nutritional requirements, too few of the latter—e.g. *Brachionus plicatilis*, *Colurella colurus* and *Keratella cruciformis*—have been cultivated for substantiating such view. Species of *Chlorella*, *Dunaliella*, *Exuviaella*, *Gymnodinium*, *Monochrysis*, *Nannochloris*, bacteria and marine yeasts, as well as protozoans, have served as food sources. Chemostat cultures proved quite successful for assessing nutritional dynamics.

The factors controlling parthenogenesis, bisexuality and sexual reproduction of rotifers are still insufficiently known. Water quality, temperature, salinity, pH, nutrition, population density and age rank highest as potential causative agents (Table 5-29); mutual chemical interactions between conspecifics and hetrospecifics cannot be ruled out. Presumably, maximum responses are obtained when two or several causative agents act in concert. Correlation analyzes revealed interrelationships between certain potential causative agents (HALBACH and HALBACH-KEUP, 1972). However, contradictory results prevail. Even in members of closely related species that inhabit the same biotope (*Brachionus calyciflorus*, *B. rubens* and *B. angularis*), different circumstances appear to induce sexuality.

The information at hand suggests that certain endogenous conditions, possibly successive stages of increasing readiness to respond to external factors, represent the major denominator for type and critical level of the causative agent(s) which ultimately triggers the onset of processes that induce bisexuality and sexual

Table 5-29

Factors that have been shown or claimed to affect the reproductive biology (parthenogenesis, bisexuality and sexual reproduction) of rotifers (After HALBACH and HALBACH-KEUP, 1972, modified and amended; reproduced by permission of Springer-Verlag)

Factors	Rotifer genus	Author
Temperature	<i>Asplanchna</i> , <i>Brachionus</i> , <i>Epiphanes</i> , <i>Keratella</i>	NUSSBAUM (1897), PUNNETT (1906), WHITNEY (1907), EDMONDSON (1965), WATZKA (1928), BUCHNER (1941b)
	<i>Brachionus</i> , <i>Epiphanes</i>	MAUPAS (1891), HALBACH (1970)
	<i>Epiphanes</i>	SHULL (1911)
Temperature change	<i>Asplanchna</i> , <i>Brachionus</i>	MORO (1915), TAUSON (1926, 1927), BUCHNER (1941b), POURRIOT (1965a), BUCHNER and KIECHLE (1966), BUCHNER and co-authors (1969)
	<i>Monostyla</i>	LADERMAN and GUTTMAN (1963)
Salinity	<i>Brachionus</i>	ITO (1960)
pH-change	<i>Asplanchna</i> , <i>Brachionus</i>	TAUSON (1925), LUNTZ (1929)
	<i>Brachionus</i> , <i>Pterodina</i>	RUMIANZEFF (1923), LUNTZ (1926), BUCHNER (1941b)
Rich nutrition	<i>Asplanchna</i> , <i>Brachionus</i> , <i>Epiphanes</i>	NUSSBAUM (1897), SHULL (1910a, b) TAUSON (1927), EDMONDSON (1965), ERMAN (1962)
	<i>Asplanchna</i> , <i>Brachionus</i> , <i>Diglena</i> , <i>Epiphanes</i> , <i>Keratella</i>	PUNNETT (1906), WHITNEY (1907) ZAWADOWSKY (1916), WATZKA (1928), BUCHNER (1941b)
	<i>Asplanchna</i> , <i>Brachionus</i> , <i>Epiphanes</i> , <i>Pedalion</i>	MITCHELL (1913), SHULL (1915), WHITNEY (1916, 1917, 1919), BUCHNER and KIECHLE (1965), BUCHNER and co-authors (1969)
Green-alga diet	<i>Asplanchna</i> , <i>Brachionus</i> , <i>Diaschiza</i> , <i>Diglena</i> , <i>Epiphanes</i>	MITCHELL (1913), WHITNEY (1914a, b, 1915, 1916), SHULL (1915), LUNTZ (1929), HERTEL (1942), GAUDENZI and ZUNARELLI (1960), BIRKY (1964), BUCHNER and KIECHLE (1965), BUCHNER and co-authors (1969)
	<i>Brachionus</i>	LUNTZ (1929), GILBERT (1963)

Table 5-29—Continued

Factors	Rotifer genus	Author
High rates of reproduction	<i>Asplanchna</i> , <i>Brachionus</i>	BUCHNER (1938, 1941a, c), BUCHNER and co-authors (1969), SEITZ and HALBACH (unpublished)
High population densities	<i>Asplanchna</i> <i>Asplanchna</i> , <i>Brachionus</i> , <i>Epiphanes</i> <i>Epiphanes</i> , <i>Brachionus</i>	BIRKY (1969) WHITNEY (1929), BUCHNER (1938, 1941b), BUCHNER and KIECHLE (1965) SHULL (1915), GILBERT (1963), HALBACH (1970), BIRKY and GILBERT (1971)

reproduction. The endogenous conditions required could be, in turn, a consequence of a variety of external and internal factors acting in concert.

Marine rotifers have not yet been used as assay organisms; however they seem to hold considerable promise.

Several Rotifera represent most useful food organisms. Both juvenile and adult stages have very successfully supported a variety of cultured invertebrates and fishes. Forms such as *Brachionus plicatilis* are small, readily digestible and easy to mass culture. High food-algae concentrations are considered important for producing maximum rotifer yields. In mass cultures, parthenogenetic (amictic) reproduction must be optimized and conditions avoided which support sexual (mictic) activities.

(7) Nematoda

Nematoda inhabit a large variety of marine environments, often in high population densities. Numerous species are specialized for life in sediment biotopes and aufwuchs assemblages. In many littoral habitats, nematodes constitute the most abundant meiofauna group and, presumably, are of fundamental ecological importance. Marine nematodes exhibit an extraordinary degree of environmental plasticity and trophic variability. However, in spite of the potentially major role that the Nematoda play in marine ecosystems (e.g. WIESER, 1959, 1960; WIESER and KANWISHER, 1961; KING, 1962), most studies devoted to marine nematodes have thus far concentrated on taxonomy and morphology.

Efforts to cultivate nematodes were, until 3 decades ago, largely directed towards parasitic or soil-living forms (e.g. NICHOLAS and co-authors, 1959, 1962; DOUGHERTY, 1960; SASSER and JENKINS, 1960; NONNENMACHER-GODET and DOUGHERTY, 1964; TARAKANOV, 1967). Early attempts to cultivate aquatic nematodes have been documented by CHITWOOD and CHITWOOD (1938). WIESER and KANWISHER (1960) determined rates of growth and respiratory metabolism in *Enoplus communis*, and WIESER (1953, 1959) provided important reviews on feeding and food selection in free-living nematodes. The studies by these early investigators, as well as those by TIETJEN, LEE, MEYERS and HOPPER (see below), still provide

essential sources of information for anyone intending to cultivate marine nematodes (see also Chapter 5.11).

Checklists of aquatic nematodes have been provided by HOPE and MURPHY (1972) and by GERLACH and RIEMANN (1973, 1974). The scientific names of aquatic nematodes mentioned below are in accordance with GERLACH and RIEMANN. Parasitic nematodes of marine animals are considered in Chapter 9.

(a) Major Species Cultivated

Aphelenchoides marinus

The stylet-bearing euryhaline nematode *Aphelenchoides marinus* was isolated from blades of the turtle grass *Thalassia testudinum* and inoculated in a medium consisting of sea-water agar, supplemented with chloroamphenicol (100 mg l⁻¹) to inhibit bacterial growth (MEYERS and co-authors, 1964). Rapid population growth was obtained in sea-water cultures devoid of supplemented nutrients except for mycelia of the fungus *Dendryphiella arenaria*. Mycelia of the deuteromycete *D. arenaria* and the ascomycete *Halosphaeria mediosetigera* were equally effective and interchangeable as food sources.

The general culture procedure employed by MEYERS and co-authors (1964) is outlined in Fig. 5-15. The fungi were grown in liquid culture (continuous shaking at 90 strokes min⁻¹) in 125-ml Erlenmeyer flasks, each containing 25 ml of 0.1% yeast extract and 1.0% glucose in sea water. For preparation of uniform standard inoculum, consult SGUROS and co-authors (1962). Prior to inoculation, a sterile glass disc of known weight was added aseptically to each flask. The disc surfaces supported rapid fungus growth leading to compact fungus mats. These mats were readily inhabited by *Aphelenchoides marinus*.

All fungus mats were aseptically washed with sea water, usually within 3 to 7 days of inoculation and then aseptically resuspended in fresh flasks containing 25 ml of sterile sea water. Flasks containing a well-established mat were inoculated with 400 to 700 nematodes from stock cultures.

Aphelenchoides marinus exhibits a feeding pattern similar to that described in detail by LINFORD (1937) for some hollow-stylet nematodes: it browses along the fungus hyphae, keeping its lip region in contact with the cell wall. At irregular intervals, the stylet suddenly pierces the wall and the nematode takes up fungus cytoplasm. Examining the ability of different fungus species to support the nematode in culture, MEYERS and co-authors (1964) obtained the 'utilization factors' listed in Table 5-30. There is evidence that increase in mycelium age causes a decrease in the utilization factor. This relationship may reflect changes in the composition of fungal cells during development.

Chromadora macrolaimoides

An abundant and ecologically significant component of macrophyte assemblages, the marine *Chromadora macrolaimoides*, was cultured by TIETJEN and LEE (1973). Samples of 0.2 g dry weight of *Enteromorpha intestinalis* and its epiphytes were brought to the laboratory and aliquots streaked out on agar plates containing

differential growth media (Table 5-9). Incubated in front of a light bank at 20° to 25° C, thriving samples were subcultured in tissue culture flasks, Petri dishes or in thin agar slants. After washing in 9-hole Pyrex spot plates containing sterile sea

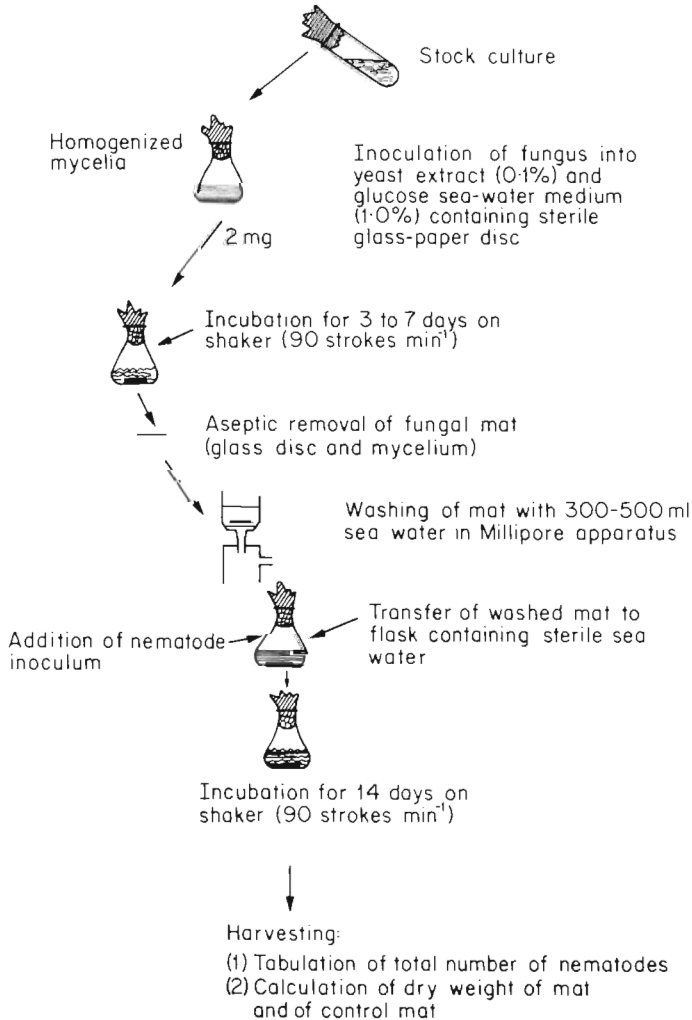

Fig. 5-15: Culture method for growing nematode populations on fungal mats in liquid culture. (After MEYERS and co-authors, 1964; modified; reproduced by permission of Society for Industrial Microbiology.)

water, *C. macrolaimoides* was transferred to fresh media with potential food organisms (algae, bacteria) carried over from the original cultures. The nematodes grew best in artificial sea water plus soil extract.

For nutritional studies, *Chromadora macrolaimoides* were harvested from stock cultures, washed by serial transfer in sterile sea water and transferred to 20- × 125-mm borosilicate test tubes containing 10 ml of Millipore-filtered sterile sea water.

Cultures of 20–25 individuals per tube were incubated under conditions identical to those of the stock cultures for 24 hrs, to starve the nematodes before feeding. ^{32}P labelled, potential food organisms were then added to the cultures at concentrations of 1×10^6 or 1×10^7 cells ml^{-1} . Harvested after 24 hrs (bacteria food) or 72 hrs (algae food), the nematodes were washed, transferred to scintillation vials and counted. Dead nematodes were used as controls. After measuring the uptake

Table 5-30

Aphelenchoides marinus. Population growth on mycelia of various fungi (Based on MEYERS and co-authors, 1964)

Fungus	Mycelia		Nematoda		Utilization factor (No. of nematodes mg^{-1} of mycelium)
	(Age in days)	(Weight in mg)	(Total number)	(Per cent on mat)	
Ascomycetes					
<i>Halosphaeria mediosetigera</i>	6	37	99,820	65	2,698
<i>Halosphaeria mediosetigera</i>	8	27	56,880	56	2,107
<i>Lulworthia floridana</i>	9	19	19,830	79	1,044
<i>Lulworthia</i> sp.	11	39	56,356	73	1,445
<i>Torpedospora</i> sp.	9	52	16,135	55	310
Deuteromycetes					
<i>Alternaria</i> sp.	4	27	48,945	85	1,813
<i>Aspergillus luchuensis</i>	4	69	3,100	87	>50
<i>Cladosporium herbarium</i>	3	58	>1,000	—	>50
<i>Culcitania achraspora</i>	6	29	69,896	62	2,410
<i>Culcitania achraspora</i>	7	94	211,582	68	2,251
<i>Dendryphiella arenaria</i>	5	35	83,286	58	2,379
<i>Dendryphiella arenaria</i>	6	42	54,160	60	1,290
<i>Dendryphiella</i> sp.	4	46	138,525	85	3,025
<i>Fusarium culmorum</i>	4	23	2,870	86	125
<i>Fusarium</i> sp.	4	49	10,130	23	207
<i>Helmisporium</i> sp.	4	37	89,510	90	2,419
<i>Hormiscium</i> sp.	4	53	>1,000	—	>50
<i>Nigrospora</i>	4	45	>1,000	—	>50
<i>Pestalotia</i> sp.	4	11	<1,000	—	<100
<i>Phoma</i> sp.	4	69	13,217	29	192
<i>Stachybotrys</i> sp.	4	16	>1,000	—	>100
<i>Zalerion xylestrix</i>	6	32	98,640	65	3,083
<i>Zalerion xylestrix</i>	7	30	47,370	47	1,579
<i>Zalerion xylestrix</i>	19	61	78,050	68	1,280

of labelled food, the number and weight of food organisms ingested per nematode day^{-1} were calculated.

The consumption recorded of ^{32}P -labelled diatoms, chlorophytes and bacteria indicates selectivity (Table 5-31): diatoms and chlorophytes are preferred. Out of a total of 20 algae species and 14 bacteria species, the diatoms *Nitzschia acicularis*

Table 5-31

Chromadora macrolaimoides. Consumption of chlorophyte and bacterial food organisms by cultured nematodes. 25° C, 26‰S (After TIETJEN and LEE, 1973; modified; reproduced by permission of Springer-Verlag)

Food organisms offered	Food organisms consumed	
	(No. organisms nematode ⁻¹ day ⁻¹)	(µg nematode ⁻¹ day ⁻¹)
<i>Amphora</i> sp. 1	2.4 × 10 ³	1.4 × 10 ⁰
<i>A.</i> sp. 2	1.3 × 10 ³	2.1 × 10 ⁻¹
<i>A.</i> sp. 3	1.3 × 10 ³	2.1 × 10 ⁻¹
<i>A.</i> sp. 4	7.9 × 10 ²	1.3 × 10 ⁻¹
<i>Chlamydomonas subehrengeri</i>	1.2 × 10 ¹	1.1 × 10 ⁻²
<i>Chlorococcum</i> sp.	8.0 × 10 ²	7.5 × 10 ⁻¹
<i>Cylindrotheca closterium</i>	7.0 × 10 ³	5.6 × 10 ⁰
<i>C. fusiformis</i>	2.1 × 10 ³	9.7 × 10 ⁻¹
<i>Dunaliella parva</i>	1.0 × 10 ³	9.4 × 10 ⁻¹
<i>D. quartolecta</i>	1.7 × 10 ²	1.6 × 10 ⁻¹
<i>D. salina</i>	6.9 × 10 ²	6.5 × 10 ⁻¹
<i>Nannochloris</i> sp. 1	1.2 × 10 ⁴	2.2 × 10 ⁰
<i>N.</i> sp. 2	1.7 × 10 ⁴	2.6 × 10 ⁰
<i>Nitzschia acicularis</i>	2.3 × 10 ⁴	1.4 × 10 ¹
<i>N. closterium</i>	4.2 × 10 ⁴	2.7 × 10 ¹
SH-1	1.0 × 10 ²	9.4 × 10 ⁻²
94	1.7 × 10 ¹	1.6 × 10 ⁻²
95	6.9 × 10 ²	6.5 × 10 ⁻¹
98	3.0 × 10 ¹	2.8 × 10 ⁻²
105	1.1 × 10 ²	1.0 × 10 ⁻¹
<i>Alcaligenes faecalis</i>	9.0 × 10 ⁰	3.3 × 10 ⁻⁶
<i>Bacillus megatherium</i>	4.0 × 10 ⁰	8.8 × 10 ⁻⁶
<i>Escherichia coli</i>	background*	—
<i>Flavobacterium marinum</i>	background	—
<i>Klebsiella</i> sp.	5.4 × 10 ¹	2.3 × 10 ⁻⁵
<i>Micrococcus</i> sp.	background	—
<i>Mycobacterium phlei</i>	background	—
<i>Proteus</i> sp.	1.6 × 10 ¹	6.4 × 10 ⁻⁶
<i>Pseudomonas fluorescens</i>	1.5 × 10 ¹	4.9 × 10 ⁻⁶
<i>P.</i> sp.	background	—
<i>Salmonella pullorum</i>	background	—
<i>Sarcina lutea</i>	2.2 × 10 ¹	1.3 × 10 ⁻⁵
<i>Serratia marcescens</i>	3.0 × 10 ⁰	6.6 × 10 ⁻⁷
<i>Streptococcus faecialis</i>	1.2 × 10 ¹	2.4 × 10 ⁻⁶

*The number of organisms consumed did not exceed the background level.

and *Cylindrotheca closterium* sustained indefinite population-growth of *Chromadora macrolaimoides*. Eleven of the 20 algae tested (all from the natural environment of the nematode) were injected at daily rates equal to, or greater than, the nematodes' body weight. Three bacteria species, isolated from the aufwuchs along with *C.*

macrolaimoides—*Micrococcus* sp., *Flavobacterium marinum* and *Pseudomonas* sp.—were not taken up in quantities above ground level. Similar to *C. macrolaimoides*, *C. axi* prefers algal food to bacteria (TIETJEN and co-authors, 1971).

At 25° C and 26‰S, *Chromadora macrolaimoides* has an average generation time of 22 days and an average total life span of 45 days. These values are similar to those found for other chromadorids studied under culture conditions. Growth rates are illustrated in Fig. 5-16. TIETJEN and LEE (1973) have not yet been able to establish *C. macrolaimoides* in bacteria-free culture. This nematode is extremely sensitive to antibiotics.

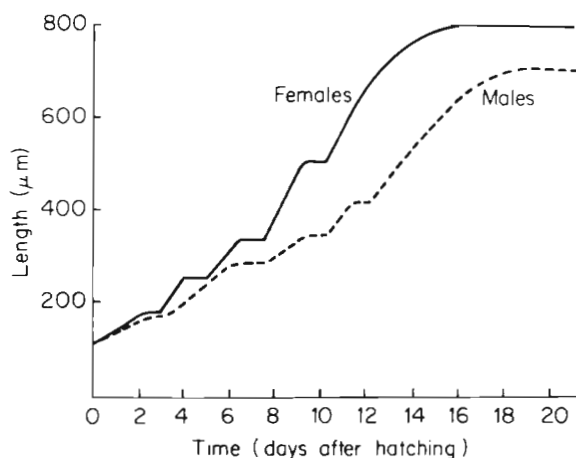

Fig. 5-16: *Chromadora macrolaimoides*. Growth rates of individuals cultured at 25° C and 26‰S. (After TIETJEN and LEE, 1973; modified; reproduced by permission of Springer-Verlag.)

Diplolaimella ocellata

Diplolaimella ocellata (syn.: *D. schneideri*) were obtained by plating small quantities of mud, collected from an intertidal, estuarine habitat, on oat agar (2 g agar with 0.5 g rolled oats per 100 ml sea water) in Petri dishes (CHITWOOD and MURPHY, 1964). Various micro-organisms (including bacteria, diatoms, ciliates and non-chlorophyll-bearing flagellates) persisted with the cultures. *D. ocellata* has also been cultured in sea water with oatmeal or cornmeal in the absence of agar; such cultures may be maintained over a period of years by adding distilled water to compensate for evaporation, and by adding nutrients as required.

Microcultures of *Diplolaimella ocellata* were prepared after JONES and co-authors (1960): a drop of sea water, containing 0.03 mg each of CaCO₃ and finely powdered cornmeal, is placed on a microscope slide, and 6 first- and second-stage juveniles are added. Two cover slips are placed next to the drop; they support a third cover slip placed over the culture; the drop-culture is then sealed with mineral oil. Juveniles mature and reproduce in approximately 40 days (20°–24° C). The

microcultures required no special attention, and over 75 days the nematodes showed no decrease in activity. The technique permits microscopic examination of the limited environment over extended periods. Addition of a small amount of debris containing associated flora and fauna elements of the stock culture seems advantageous.

Metoncholaimus scissus

An intensively studied marine nematode (HOPPER and MEYERS, 1966a; MEYERS and HOPPER, 1966; HOPPER and co-authors, 1970; MEYERS and co-authors, 1970; MEYERS and HOPPER, 1973), the large, 4-mm long oncholaimid *Metoncholaimus scissus* has been accommodated successfully in *in situ* culture.

Both in sea-water agar and on fungal-cellulose mats, *Metoncholaimus scissus* exhibits characteristic dorso-ventral undulatory movements, the head probing constantly as if 'seeking food' or 'testing' the environment (HOPPER and MEYERS, 1966a). While most species of *Metoncholaimus* are assumed to be predators, only few records on predation are available: SCHUURMANS STEKHOVEN (1933) has reported *Oncholaimus dujardinii* to feed on internal organs of the bryozoan *Zoobotryon pellucidum*; MEYERS and co-authors (1970) observed *M. scissus* feeding on small ciliates, but believe that random ingestion of fine sediment and detritus is more typical. Similar conclusions have been drawn by COBB (1930, 1932) in regard to *M. pristiurus*.

Carnivorous or omnivorous, *Metoncholaimus scissus* readily inhabits substrata consisting of cellulose and fungus mycelia exposed to *in situ* conditions. The two marine fungi used were *Dendryphiella arenaria* and *Halosphaeria mediosetigera*. In laboratory cultures, both fungi form compact mycelial mats on cellulose or on filter-paper discs. The mycelial mats were mounted on a wooden frame and exposed to *in situ* conditions (Fig. 5-17). On the mats, mostly gravid females were recorded, with only occasional males and juveniles. One mat, submerged for 24 hrs, revealed a population of 98 gravid females and 1 juvenile; another mat, submerged for 72 hrs, showed 599 gravid females, 11 males and 11 juveniles (MEYERS and HOPPER, 1966). Regular collections of natural sediment in the immediate neighbourhood of the *in situ* cultures yielded a sex ratio of 50:50. MEYERS and HOPPER (1966, 1967) postulate that the substances attracting the females may originate from degradation processes of the fungal cellulose complex, or from associated microbiota rapidly establishing itself on such degrading substrata. The *in situ* method developed holds promise for a variety of ecological experiments on life cycle, nutrition and responses to environmental factors.

In sediment samples, collected from a *Thalassia testudinum* bed, MEYERS and co-authors (1970) recorded about 2.68×10^6 individuals of *Metoncholaimus scissus* under one square metre of 1.5 cm depth (up to 28 g wet weight m^{-2}). Such tremendous population densities were concurrent with blooms of the benthic diatom *Pleurosigma balticum*. Older diatom mats appeared to provide a particularly favourable environment.

Monhystera Species

A member of aufwuchs assemblages of marine macrophytes, *Monhystera denti-*

culata was isolated from *Zostera marina* and established in culture by TIETJEN and LEE (1972). Employing methods similar to those used for *Chromadora macrolaimoides* (p. 692), *M. denticulata* eventually was sustained on a solid medium consisting of an artificial sea-water base (see TIETJEN and co-authors, 1970), nutrient agar (Oxoid Agar No. 3; 11.5 g l⁻¹) and peptone (BBL Gelysate® Peptone, 500 mg l⁻¹). Food organisms comprised bacteria carried over from the original cultures.

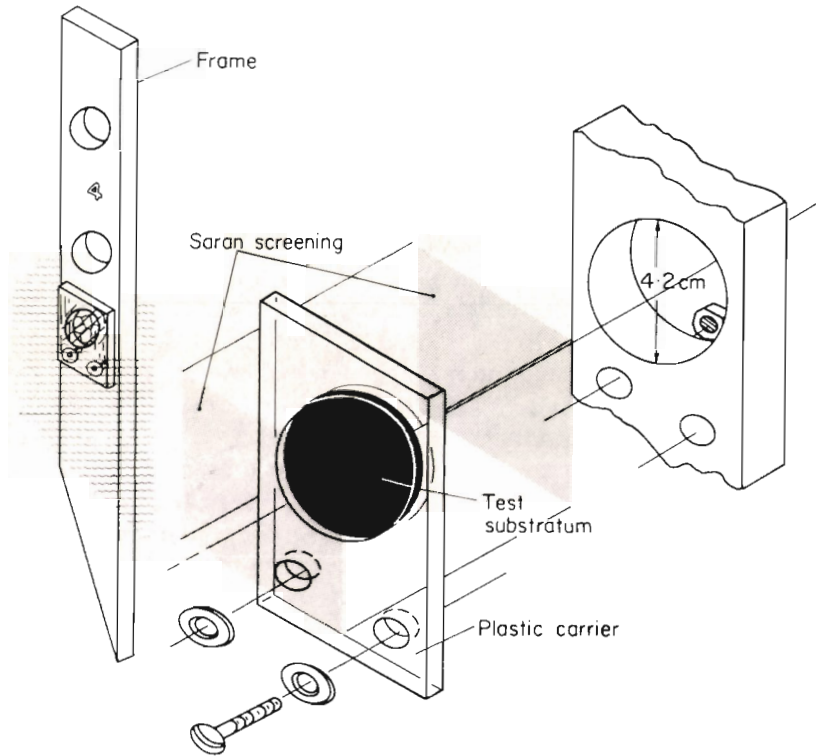

Fig. 5-17: Frame, plastic carrier and test substratum (cellulose-fungal mat or control) for *in situ* cultures of marine nematodes. Saran screening encloses the test-substratum chamber. (After MEYERS and HOPPER, 1967; modified; reproduced by permission of Biologische Anstalt Helgoland.)

At 25° C and 26‰S, and under optimum growth conditions, *Monhystera denticulata* has a generation time of 10–12 days. Generation times obtained under suboptimum conditions are listed in Table 5-32, as are details on ontogenetic development and reproductive biology. Growth rates of females and males are illustrated in Fig. 5-18. Assuming optimum conditions, a maximum of about 15 generations of the nematode could occur each year in the natural habitat. However, TIETJEN and LEE (1972) expect the real annual number of generations to be less, due to the fact that the females deposit their eggs over a period of several days.

Monhystera disjuncta has been collected by CHITWOOD and MURPHY (1964) from macro-algae (including *Egrecia laevigata*, *Postelsia palmaeformis* and *Lamin-*

Table 5-32

Monhystera denticulata. Life-cycle data obtained from individuals cultured under different temperature and salinity conditions. All times expressed in days; the culture experiment terminated after 330 days (After TIERTJEN and LEE, 1972; modified; reproduced by permission of Springer-Verlag)

Function	5° C			15° C			25° C		
	13‰S	26‰S	39‰S	13‰S	26‰S	39‰S	13‰S	26‰S	39‰S
Egg development	14-22	13-20	4-6	3-4	5-6	2-3	2-3	2-3	2-3
Post-embryonic development (hatching to sexual maturity)	154-182	145-170	25-34	11-14	21-30	15-20	5-8	12-19	12-19
Maturation period (sexual maturity to maximum body size)	121-144	115-137	13-25	9-13	10-18	8-15	3-6	8-16	8-16
Copulation to egg deposition	5-6	5-6	1-2	1-2	1-2	1	1	1	1
Generation time (egg to egg)	173-204	163-196	30-41	15-20	27-38	18-24	8-12	15-22	15-22
Average generation time	197	180	36	18	34	20	10	17	17
Total life span (average)	at least 330		69	53	57	37	34	29	29
Number of eggs female ⁻¹	8-19	10-17	12-21	18-24	15-23	16-22	18-23	15-23	15-23

aria sinclairii), and propagated in sea water with decaying blades of *L. sinclairii* (see also DOUGHERTY, 1960). Later, the nematodes were transferred to oat-agar test tubes, containing about 0.2% rolled oats. Where fungi became predominant, the cultures declined and finally all nematodes died; cultures without fungi thrived. Apparently, males are required for reproduction. At 20° to 24° C, CHITWOOD and MURPHY found the life cycle to be completed within 30 days.

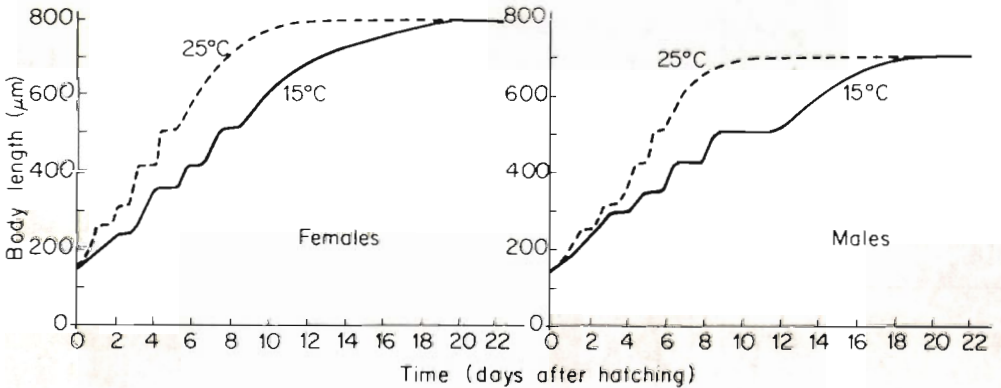

Fig. 5-18: *Monhystera denticulata*. Growth rates of females and males in 26‰ S. (After TIETJEN and LEE, 1972; modified; reproduced by permission of Springer-Verlag.)

Monhystera disjuncta, collected from rhizoids of *Laminaria* species in the rocky intertidal near Helgoland (southern North Sea), have been isolated and individually transferred into Boveri dishes placed in wet chambers to reduce evaporation (GERLACH and SCHRAGE, 1971). Small pieces cut from a 3-mm agar plate (sea-water agar and 0.2 g 100 ml⁻¹ nutrient solution according to KILLIAN in: VON THUN, 1968) served as substratum. The worms enter the agar, but can easily be observed as long as micro-organisms (bacteria, fungi, diatoms, ciliates or foraminiferans) do not grow abundantly. Whenever an overgrowth of these organisms began to occur, the nematodes were subcultured. Each week about 40% of the sea water (ca 32‰ S) was replaced. The lowest temperature levels offered sometimes caused vivipary. Average minimum generation times of *M. disjuncta* are illustrated in Fig. 5-19. At 17° to 22° C, minimum generation time is 13 days and a *M. disjuncta* female carries on average more than 37 eggs; the reproductive period exceeds 20 days; the total life span amounts to 61 days. Generation time is much shorter than reported by other authors (CHITWOOD and MURPHY, 1964: 30 days at 20° to 24° C; VON THUN, 1968: 18 to 28 days at 20° to 22° C).

Monhystera filicaudata was isolated from sediment of a Rhode Island estuary (USA), and maintained in culture at 20° to 25° C by TIETJEN (1967). Sediment samples were dispersed in 50 ml of filtered (Millipore HA, pore size 0.45 µm) estuarine water in 125-ml Erlenmeyer flasks, to which were added pieces of decaying *Zostera marina* with aufwuchs (filamentous blue-green algae, pennate diatoms, ciliates, bacteria, colourless euglenoids, dinoflagellates). The flasks were stoppered with cotton plugs. Within 10 weeks, the nematode fauna, which had originally

consisted of about 25 species, was comprised solely of large numbers of *M. filicaudata*. Ten flasks were maintained as stock cultures under continuous fluorescent illumination which enhanced the growth of dinoflagellates. An additional 10 flasks were maintained in a dark room. *M. filicaudata* grew well under both conditions, and was successfully subcultured.

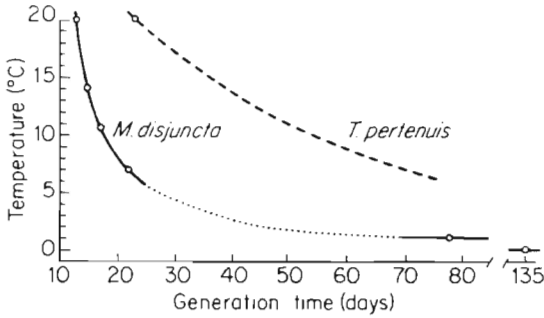

Fig. 5-19: *Monhystera disjuncta* and *Theristus pertenuis*. Average minimum generation times as a function of culture temperature. Dim daylight; natural photoperiods; about 32‰S. (After GERLACH and SCHRAGE, 1971; reproduced by permission of Springer-Verlag, Berlin.)

Monhystera filicaudata feeds by moving through the culture medium with dorso-ventral undulatory movements, anchoring itself to the substratum by caudal adhesive glands, moving its head vigorously and ingesting small pieces of detritus (TIETJEN, 1967). Microscopic examination revealed the presence of detritus throughout the entire gut. *M. filicaudata* could also be sustained on bacteria (e.g. *Arthrobacter* sp., *Pseudomonas* sp., *Vibrio* sp., *Flavobacterium* sp.) isolated from the culture medium, but not on whole filaments of blue-green algae or ciliates. Dinoflagellates were readily accepted as food, and there is every reason to assume that dinoflagellates may constitute an important food source for *M. filicaudata* in the natural habitat. Faeces and pseudofaeces of the bay scallop *Aequipecten irradians* were also accepted during a 9-month experiment; however, no reproduction was observed. If placed in filtered estuarine water, the nematodes died after 1 month. At 20° to 25° C, *M. filicaudata* require 24 to 35 days from hatching to reproduction. Females outnumber males at a ratio of 20:1 both in cultures and in the natural habitat.

Panagrellus sp.

An undetermined species of *Panagrellus* has been grown by KAHAN and APPEL (in press) at 25° C in 14‰S sea water, employing covered plastic boxes (18 × 30 × 7 cm deep) as culture enclosures. The culture medium contained oatmeal, 50 ml (5‰, m/v); yogurt, 20 ml; and sea water, 50 ml. In salinity tests, good growth was obtained in 5‰ and 10‰S; in 30‰S, growth rates were significantly reduced. Sterile wheat grains and *Escherichia coli* suspensions served as food sources.

Rhabditis marina

Rhabditis marina has been isolated from a shallow marine embayment (Long Island, USA) and established in gnotobiotic culture by LEE and co-authors (1970) and TIETJEN and co-authors (1970); see also CHITWOOD and TIMM (1954) and Chapter 5.11. Samples (0.2 g dry weight) of *Zostera marina*, *Enteromorpha intestinalis* and other marine macrophytes, including their aufwuchs, were removed with sterile forceps and inoculated into 25 × 150-mm screw-cap test tubes containing 30 ml of sterile habitat sea water. After refrigerating all samples as soon as possible in an insulated ice chest, samples containing more than 50 nematodes were processed further in a nearby field laboratory. Small portions of a sample were inoculated into a series of liquid or solid differential growth media (LEE and co-authors, 1966, 1970, Table 5-9) and also streaked out on solidified agar plates of the same media. Incubation at 15° or 25° C was followed by periodical examination for the development of nematode 'blooms'. When blooms occurred, the worms were subcultured in tissue-culture flasks, Petri dishes, or on agar slants. After aseptical washing in 9-hole spot plates containing sterile sea water (sometimes with antibiotic mixtures), the nematodes were inoculated into fresh media with potential food organisms isolated axenically from the same habitat.

In the original subcultures from agnotobiotic stocks, fungal mycelia were present. To eliminate these, TIETJEN and co-authors (1970) applied Fungizone (50 µg to 50 mg ml⁻¹). After 4 serial transfers no mycelia were recovered, neither at high nor at low Fungizone concentrations. Apparently, the concentration of the fungicide is not very important (perhaps because of low solubility in the media); the nematodes survived well, even at the highest concentration employed. Using practically the same culture methods, LEE and co-authors (1970) stress the importance of physical media characteristics. For example, *Rhabditis marina* requires the agar slopes to be parallel to the test-tube walls. In slopes deeper than 4 mm, the nematodes bury themselves deeply in the agar and die. Their bodies were found by the tracks of bacterial colonies which grew in the tunnels formed. In liquid media, survival is poor. LEE and co-authors now grow most of their stocks in Pyrex screw-cap test tubes with a long slope and 2 to 5 mm liquid overlay of the same medium. The tubes are incubated horizontally in test-tube racks turned on their sides.

Synxenic cultures of *Rhabditis marina* were followed by trixenic cultures with 3 bacteria as food sources: *Micrococcus* sp., *Pseudomonas* sp. and *Flavobacterium marinum*. Harvested from stock cultures, the nematodes were gently washed aseptically in fresh liquid media employing a vortex mixer, and inoculated into the 3 media containing Erythromycin (50 µg ml⁻¹). Trixenic cultures have been sustained for 120 generations (LEE and co-authors, 1970; TIETJEN and co-authors, 1970).

Monoxenic cultures of *Rhabditis marina* were established, with the aid of 200 µg ml⁻¹ of Erythromycin, over more than 80 generations using *Pseudomonas* sp. as food organism. According to LEE and co-authors (1970), the Erythromycin concentration applied is bacteriocidal for *Micrococcus* sp. and *Flavobacterium marinum*, and bacteriostatic for *Pseudomonas* sp.

Axenic cultures of *Rhabditis marina* (Chapter 5.11) have been established after aseptic washing and application of 200 to 333 µg ml⁻¹ of Erythromycin (LEE and co-authors, 1970). The cultures were serially transferred 2 or 3 times in marine nutrient agar and medium 10 + Bacto Peptone 0.05%. It has not yet been possible

to replace living bacteria as food source, although various crude materials have been tried, e.g. BBL Trypticase, casein hydrolysate, serum fractions, yeast extract, Bacto Peptone, Mycological Peptone, sonicated bacteria, and metabolites such as amino-acid mixtures, or vitamin mixtures. Possibly, a number of nematodes are, to a certain extent, food specialists. Several species developed successfully on some species of algae but not on others, including closely related forms.

The life cycle of *Rhabditis marina* is completed, under 'normal' laboratory conditions, in 5 days. Marine nutrient agar supports good growth. Maximum growth occurs between 25° and 30° C and 45 and 55‰S. Growth rates obtained at 25° C and in 25‰S are illustrated in Fig. 5-20. Normal development is oviparous, but

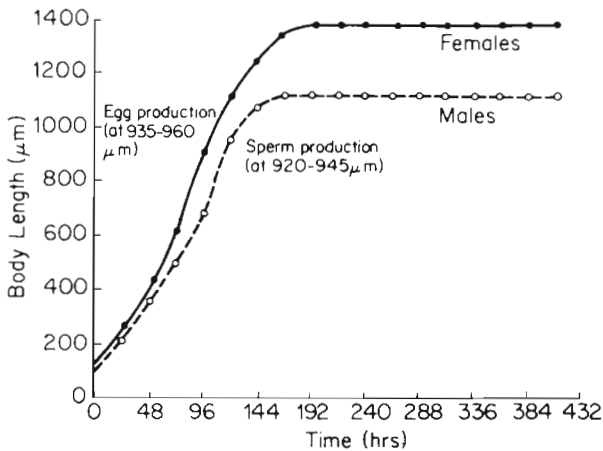

Fig. 5-20: *Rhabditis marina*. Growth rates of cultured nematodes (25° C; 25‰S). Each point represents the mean value recorded in 50 individuals. (After TIETJEN and co-authors, 1970; modified; reproduced by permission of American Society of Limnology and Oceanography.)

ovoviviparous development has been observed in older females. Reproduction takes place over wide ranges of temperature (10° to 38° C) and salinity (fresh water to 80‰S, the highest salinity tested).

Theristus pertenuis

Collected with rhizoids of *Laminaria* species, *Theristus pertenuis* was cultivated by GERLACH and SCHRAGE (1971) under conditions identical to those employed for *Monhystera disjuncta* (p. 700). In the North Sea, *T. pertenuis* presumably produces a maximum of 5 to 6 generations per year.

(b) Other species

The intertidal nematode *Deontostoma californicum* lives in the matrix of sand, detritus and decaying organic matter found in holdfasts of *Laminaria digitata* and *Egregia laevigata*. Its gut contains diatoms, algae and faunal fragments. In an attempt to establish laboratory cultures, VIGLIERCHIO and JOHNSON (1971) found

CaCO₃-cornmeal-sea-water medium (CHITWOOD and MURPHY, 1964), sugar-sea-water-agar medium (alone or inoculated with fragments of raw holdfast matrix) and balanced salt solutions (used for excised organ cultures) unsuitable. In sea water chilled to 4° C, the nematodes survived several weeks, provided the water was aerated and exchanged daily. Approximately 50% of the eggs mechanically forced (stripped) from the uteri of gravid females, and incubated in sea-water dishes sealed with petroleum jelly under a cover slide at 15° C, developed into normal juveniles after 30 days.

Nematodes such as *Acanthonchus cobbi*, *Chromadora macrolaimoides*, *Euchromadora gaulica*, *Monhystera parelegantula*, *Chromadorina epidemos* and *Viscosia macramphida* have been cultivated by MEYERS and co-authors (1964), HOPPER and MEYERS (1966a, b) and MEYERS and HOPPER (1966, 1967) on mats of fungi mycelia. *A. cobbi* was isolated from a fungal mat submerged for 6 days in a sea-grass community (HOPPER and MEYERS, 1966b). A small portion of the mycelial mat containing about 20 *A. cobbi* was inoculated on 0.5% sea-water agar fortified with washed cells of a marine yeast (MY-111, *Kluyveromyces aestuarii*). After 48 days, a large *A. cobbi* population had established itself. The other nematode species mentioned above were isolated and cultivated in a similar way. No details on temperature, salinity, water movement, etc., are available. Life cycles of approximately 1 month were recorded. *A. cobbi*, *C. macrolaimoides* and *E. gaulica* reproduce amphimictically. *M. parelegantula* is parthenogenetic, and *C. epidemos* and *V. macramphida* are able to reproduce either by amphimixis or parthenogenesis. While found in the field with about equal commonness, *V. macramphida* males and females change their ratios under laboratory conditions: after about 10 days, all sexually mature specimens on the fungal-infested cotton cellulose filter were parthenogenetic females.

Diplolaimelloides sp., *Enoplus paralittoralis*, *Haliplectus dorsalis* and *Oncholaimus* sp. have been isolated by HOPPER and co-authors (1973) from decaying mangrove (*Rhizophora mangle*) leaves, placed on the surface of agar plates (Difco Corn Meal Agar, 8.5 g l⁻¹ in filtered brackish water of 15‰S). Subcultures were established by transferring nematodes with accompanying micro-organisms in small pieces of agar to fresh agar plates. The bacteria present appear to serve as primary food source. From stock cultures maintained at ca 24° C, freshly deposited eggs were transferred in small pieces of agar to new plates. Generation times decrease with increasing temperature up to about 33° C; above this level they increase again over a few centigrade degrees until reproduction ceases and death occurs (at 35° to 39° C in most cases).

The main results obtained by VON THUN (1968), who cultivated several brackish-water nematodes, are listed in Table 5-33). VON THUN used micro-aquaria (Fig. 2-160, p. 246) containing brackish-water agar as culture medium. He obtained somewhat longer generation times for *Monhystera disjuncta* than GERLACH and SCHRAGE (1971). Possibly, his techniques involved reduced gaseous exchange between air and medium.

Very long generation times were recorded by GERLACH and SCHRAGE (1972) in *Oncholaimus brachycercus* (399 days), *Desmodora scaldensis* (603 days) and *Halichoanolaimus robustus* ('much longer'). These three nematodes were kept in Boveri dishes containing sea water of about 32‰S and small pieces of *Laminaria*

Table 5-33

Life-cycle data for 6 brackish-water nematodes cultivated at 20° to 22° C. Brackets: average generation times (After VON THUN, 1968; modified; reproduced by permission of the author)

Species	Number of eggs female ⁻¹	Egg development (days)	Hatching to appearance of spicules and vulva (days)	Maturation (days)	Reproductive period of ♀ (days)	Total life span (days)	Generation time (juvenile to first and last juvenile of next generation) (days)	Culture of salinity (%)
<i>Adoncholaimus thalassophygas</i>	14-22 average: 17	4-6	40-45	several	2-8	78	55-72 average: 63	?
<i>Chromadorita tenuis</i>	16-28 average: 20	4-5	10-12	2-3	5-11	43	19-34 average: 26	15
<i>Diplolaimella ocellata</i>	12-26 average: 22	5-6	10-14	2-3	7-12	56	22-39 average: 29	15
<i>Diplolaimelloides oschei</i>	24-42 average: 36	4-5	16-18	2-4	6-9	54	23-35 average: 29	20
<i>Diplolaimelloides islandica</i>	16-25 average: 22	4-5	17-21	2-4	4-8	50	24-39 average: 31	15
<i>Monhystera disjuncta</i>	14-20 average: 16	5-6	13-15	2-3	2-8	33	18-28 average: 23	5

sp. The sea water was renewed every 3 to 4 weeks. Except for *D. scaldensis*, the cultures were later transferred to sea-water Killian agar. All cultures were kept under weak daylight at 7° C (Tables 5-34 and 5-35). GERLACH and SCHRAGE could not observe any feeding; they assume that the nematodes fed on bacteria, fungi, diatoms and ciliates which grew in the cultures. Possibly, a more adequate nutrition may have led to shorter generation times. Further experiments are necessary to elucidate the nutritional requirements of these nematodes.

Table 5-34

Oncholaimus brachycercus and *Desmodora scaldensis*. Duration of development (in days) in unfed cultures kept under weak daylight at 7° C in 32‰ S. Presumably, the nematodes thrived on a variety of micro-organisms present (After GERLACH and SCHRAGE, 1972; modified; reproduced by permission of Institut für Meeresforschung, Bremerhaven)

Life-cycle stage	<i>Oncholaimus brachycercus</i>			<i>Desmodora scaldensis</i>		
	Min	Max	Average	Min	Max	Average
Embryonic development (oviposition to hatching)	35 (21-51) <i>n</i> = 8	52 (42-59) <i>n</i> = 8	44	31 (21-43) <i>n</i> = 13	57 (41-73) <i>n</i> = 15	44
Postembryonic development (hatching to appearance of sexual characters)	156 (134-170) <i>n</i> = 10	204 (159-284) <i>n</i> = 9	180	380 <i>n</i> = 1	418 <i>n</i> = 1	399
Adult development (appearance of sexual characters to first eggs in uterus)	62 (61-63) <i>n</i> = 2	85 (76-94) <i>n</i> = 2	74	90 (71-127) <i>n</i> = 3	136 (109-161) <i>n</i> = 3	113
Gamete maturation (first eggs in uterus to first oviposition)	83* (56-113) <i>n</i> = 3	118* (87-135) <i>n</i> = 3	101	34 (14-53) <i>n</i> = 2	60 (54-66) <i>n</i> = 2	47
Length of life cycle (egg to egg)			399			603

*Figures include observations of several nematodes cultured together in one dish.

In addition to *Rhabditis marina* (p. 702), LEE and co-authors (1970) cultivated the marine nematodes listed in Table 5-36.

Collecting *Deontostoma californicum* from holdfasts of *Laminaria digitata* and *Egagria laevigata*, CROLL and VIGLIERCHIO (1969) maintained this nematode in sea water, changed at weekly intervals, on gauze. A report of an incidental culture of *Halicephalobus limuli* on algal scrapplings from *Limulus polyphemus* (TIMM, 1956) requires confirmation. The first case of a microsporidian infection in a marine nematode, *Metoncholaimus scissus*, has been reported by HOPPER and co-authors (1970). Infection occurs throughout the year and affects most of the host tissues.

(c) Nematoda as Assay and Food Organisms

The potential role of marine nematodes as indicators of water-quality and pollution load has remained unexplored. DEL VALLE (1960) suggests the use of *Pelodera (Rhabditis) strongyloides* as a bioassay organism for staphylococcal enterotoxin. The feasibility of employing nematodes as indicator organisms of pollution or 'ecosystem imbalances' (MEYERS and HOPPER, 1973) invites investigation.

Table 5-35

Duration of egg development from oviposition to hatching (in days) in nematodes cultivated at two different temperature levels. See also legend to Table 5-34 (After GERLACH and SCHRAGE, 1972; reproduced by permission of Institut für Meeresforschung, Bremerhaven)

Species	7° C			11°-22° C Average
	Min	Max	Average	
<i>Anticoma pellucida</i>	37 (32-42) <i>n</i> = 7	48 (45-53) <i>n</i> = 8	43	—
<i>Desmodora scaldensis</i>	See Table 5-34		44	10 (17°-22° C)
<i>Halichoanolaimus robustus</i>	141 (115-159) <i>n</i> = 12	158 (141-186) <i>n</i> = 12	150	—
<i>Monhystera disjuncta</i>	2 (1-7) <i>n</i> = 12	8 (4-12) <i>n</i> = 13	5	4 (17°-22° C)
<i>Oncholaimus brachycercus</i>	See Table 5-34		44	25 (11°-18° C)
<i>Theristus pertenuis</i>	9 (4-13) <i>n</i> = 7	13 (10-21) <i>n</i> = 13	11	4 (17°-22° C)

Ecologists have repeatedly recorded extremely high biomass values of nematodes in littoral offshore sediments. This fact has lent support to the assumption that nematodes play a fundamental role (i) in food-web relationships, especially in regard to dynamic exchanges between sediment and free water, and (ii) as potential food source for cultivated animals. Both assumptions require verification. The potential usefulness of nematodes for other cultivated animals has received little attention. When fed exclusively with nematodes, cultured *Crangon crangon* survived up to 210 days, while unfed controls died within 27 to 47 days (GERLACH and SCHRAGE, 1969). These two authors used the saprobic nematode *Panagrellus redivivus* as test animal; it has a dry weight (0.0003 to 0.0015 mg) and size similar to marine free-living nematodes. For periods of up to half an hour, *C. crangon* caught the nematodes at the rate of 5 worms min⁻¹. The total dry weight of all

nematodes thus consumed amounted to about 0.2 mg. This is much less than when large prey such as polychaetes are consumed (up to 1.5 mg dry weight 30 min⁻¹). GERLACH and SCHRAGE conclude that *C. crangon* cannot thrive on a diet consisting exclusively of nematodes, but may avoid critical starvation.

KAHAN and APPEL (in press) believe that *Panagrellus* sp. can serve as adequate food source for small fish. They determined the nutritional value of the nematode (52% protein, 15.4% carbohydrates, 13% lipids) and report that freshwater fish (*Danio malabaricus*, *Lebistes reticulatus*) grow quite well on this food.

Table 5-36

Marine nematodes sustained in continuous culture by LEE and associates (After LEE and co-authors, 1970; reproduced by permission of Biologische Anstalt Helgoland)

Nematode	Medium	Extent of development*
<i>Rhabditis marina</i>	Marine nutrient agar**	Monoxenic with <i>Pseudomonas</i> sp. in continuous culture for 16 months (80 generations)
<i>Chromadora</i> sp.	Erdschreiber 3	Synxenic with B1 38, B1 27, and 38 plus several species of bacteria; in continuous culture 12 months (24 generations)
<i>C. axi</i>	Erdschreiber 3	Aseptically transferred with B1 38 and unknown bacteria; in continuous culture 4 months (8 generations)
<i>C. quadrilinea</i>	Erdschreiber 3	Aseptically transferred with B1 38, B1 52 and unknown bacteria; in continuous culture 4 months (8 generations)
<i>Oncholaimus paralangruensis</i>	Erdschreiber 3	Aseptically transferred with B1 38 + unknown bacteria; in continuous culture 4 months; 2-3 generations
<i>Viscosia carnleyensis</i>	Sea water	Agnotobiotic; in continuous culture 25 months

*For explanation see MULLER and LEE (1969).

**Components: nutrient agar (Difco 0001-01), 23 g; distilled water, 500 ml; sea water, 500 ml; sterilization: 15 mins at 1.02 atm in an autoclave.

(d) Nematoda: Conclusions

Interest in cultivating marine and brackish nematodes is young. Adequate culture methods remain to be worked out for most representatives. Much more work, especially on life cycles, reproductive potential, nutritional requirements and environmental dependence is needed before we can assess in detail the presumably important role which this abundant meiofauna group plays in the dynamics of marine environments. Responses of cultured nematodes to environmental variation is still a virgin field, except for a few data on temperature and salinity effects. There are more gaps than facts.

The information at hand indicates diversity of environmental requirements, feeding habits and nutrition. Table 5-37 lists the media and food sources used for cultured nematodes, generation times and life spans. It testifies to a considerable variation in environmental and nutritive requirements and—together with related data on egg production, growth rates and biomass—to high rates of productivity. Most nematodes examined thus far utilize decaying or living micro-organisms (bacteria, fungi) or algae, associated with sediment habitats. *Rhabditis marina* could be sustained in monoxenic culture with the bacterium *Pseudomonas* sp. as sole food organism for over 4 years (TIETJEN and co-authors, 1970; TIETJEN and LEE, 1973) and now is being kept in axenic culture; it is the only marine nematode on which quantified nutritional information has become available. Accumulation of nematodes has been obtained by employing environmental gradients (e.g. thermal, osmotic) or by letting the nematodes emigrate from aging cultures.

A variety of fungi constitute food sources for several marine nematodes (MEYERS and co-authors, 1963, 1964; HOPPER and MEYERS, 1966a, b; MEYERS and HOPPER, 1966, 1967, 1973), as well as for some non-marine representatives (e.g. FAULKNER and DARLING, 1961). In marine sediment habitats, relationships between nematodes, bacteria, fungi and algae seem to be of considerable importance.

Nematode cultures can provide essential tools for analyzing micro-habitat interrelationships, exchanges between sediment and free water, as well as nutritional and chemical interactions between co-existent sediment or aufwuchs dwellers. Nematodes have been suspected to be of great significance as hosts of viruses, bacteria, protozoans and other agents causing diseases in a variety of marine animals (KINNE (in press)). In this capacity, nematodes could conceivably participate in affecting or, at times, controlling mass fluctuations in organismic abundances both in space and time. More culture experiments are required in order to provide firm ground for such assumption.

The potential roles of cultured nematodes as assay and food organisms remain to be explored. Here seems to lie much fertile ground for future work.

(8) Bryozoa

A marine group with few limnic representatives, the Bryozoa* are sedentary suspension feeders which depend largely on small phytoplankters as main food source. Most bryozoans form encrusting colonies on substrata such as stones, shells, seaweeds or wood; only a few species grow erect colonies. Many bryozoans are polymorphic. A few species exhibit marked substratum specificity. *Membranipora membranacea*, for example, grows almost exclusively on the fronds of *Laminaria* species. Of the considerable variety of bryozoan larvae, only few (e.g. the Cyphonautes of *Electra pilosa*) possess an alimentary canal and hence require feeding. This fact simplifies cultivation.

Of the bryozoans thus far cultivated, several have accepted glass or plastic as

* Since the phylum Bryozoa (or Polyzoa) comprises two groups with different structures, Entoprocta and Ectoprocta, HYMAN (1959, p. 277) has suggested that these two groups be given phylum status with the elimination of the concept Bryozoa. However, except in North America, few zoologists have followed this suggestion. Hence, we retain here the original phylum Bryozoa.

Table 5-37

Media, food, temperature, generation time and life span for marine and brackish nematodes established in cultures (Compiled from the sources indicated)

Species	Medium	Food source	Temperature (°C)	Generation time (days)	Life span (days)	Author
<i>Adoncholaimus thalassopygus</i>	Brackish-water agar (no details)	Pieces of oligochaetes	20 to 22	63 (average)	78	VON THUN (1968)
<i>Aphelaechooides marinus</i>	Sea water (35‰ S) (tolerates a wide variety of salinities)	Washed mycelia of fungi such as <i>Dendryphiella arenaria</i> , <i>Halosphaeria mediosetigera</i>	20 to 25	6 to 7	—	MEYERS and co-authors (1964)
<i>Chromadora macrolaimoides</i>	Marine nutrient agar, media 9 and 10 (Table 5-9)	Bacteria, diatoms (<i>Nitzschia acicularis</i> , <i>Cylindrotheca closterium</i>), Chlorophytes	25	22 (average)	45	TJETTJEN and LEE (1973)
<i>Chromadora tenuis</i>	Brackish-water (15‰ S) agar with modified KILLIAN nutrient solution	Bacteria, yeasts, flagellates	20 to 22	26 (average)	43	VON THUN (1968)
<i>Desmodora scaldensis</i>	Sea water (32‰ S)	Aufwuchs on small pieces of <i>Laminaria</i> sp.	7	603	—	GERLACH and SCRIBAGE (1972)
<i>Diplolaimella ocellata</i>	Sea water with or without agar	Rolled oats, oatmeal, cornmeal	20 to 24	ca 40	—	CHITWOOD and MURPHY (1964)
<i>Diplolaimella ocellata</i>	Brackish-water (15‰ S) agar	Bacteria, yeasts, flagellates	20 to 22	29 (average)	56	VON THUN (1968)
<i>Diplolaimella ocellata</i>	Brackish-water (15‰ S) agar	Cornmeal	35 33 30 24 21 18	8 (average) 6.5 6 11.5 12 4.3	—	HOPPER and co-authors (1973)
<i>Diplolaimelloides islandica</i>	Brackish-water (15‰ S) agar	Bacteria, yeasts, flagellates	20 to 22	31 (average)	50	VON THUN (1968)
<i>Diplolaimelloides oschei</i>	Brackish-water (20‰ S) agar	Bacteria, yeasts, flagellates	20 to 22	29	54	VON THUN (1968)

BRYOZOA

Species	Substrate	Medium	Notes	Percentage	Temperature (°C)	Author
<i>Diplolaimellodes</i> sp.	Cornmeal	Brackish-water (15‰S) agar		37	7 (average)	HOPPER and co-authors (1973)
				35	4	
				33	4	
				30	4.5	
				24	7	
				21	9.5	
				18	14	
12	30					
<i>Enoplos paratittoralis</i>	Cornmeal	Brackish-water (15‰S) agar	31	27 (average)	HOPPER and co-authors (1973)	
			28	21		
			24	22		
			21	41		
			21	41		
<i>Halipectus dorsalis</i>	Cornmeal	Brackish-water (15‰S) agar	35	35 (average)	HOPPER and co-authors (1973)	
			33	26		
			30	27		
			24	34		
			21	70		
			21	112		
			18	112		
<i>Melanolaimus scissus</i>	Mycelia of <i>Dendryphella arenaria</i> and <i>Hatosphaeria mediosetigera</i>	Sea water (35‰S)	22 to 24	ca 40	MEYERS and co-authors (1964)	
			22 to 24	ca 40		
<i>Monhystera denticulata</i>	Bacteria carried over from original cultures	Solid medium of sea-water base, nutrient agar and peptone	25 (26‰S)	10-12 (minimum)	TIETJEN and LEE (1972)	
			25 (13‰S)	20 (average)		
			25 (39‰S)	17		
			15 (26‰S)	18		
			15 (13‰S)	36		
15 (39‰S)	34					
<i>Monhystera disjuncta</i>	<i>Laminaria</i> blades; rolled oats	Sea-water agar, decaying blades of <i>Laminaria sinclairii</i> ; oat agar	20 to 24	30	CHITWOOD and MURPHY (1964)	
			20 to 24	30		
<i>Monhystera disjuncta</i>	Aufwuchs: bacteria, fungi, diatoms, ciliates	Sea-water (32‰S) agar with modified KILLIAN nutrient solution	17 to 22	13 (minima)	GERLACH and SCHRAGE (1971)	
			13 to 15	15		
			9 to 12	17		
			7	22		
			0 to 2	77		
—1 to 1	135					
<i>Monhystera disjuncta</i>	Bacteria, yeasts, flagellates, algae	Brackish-water (5‰S) agar	20 to 22	23 (average)	VON THUS (1968)	
<i>Monhystera filicaudata</i>	Decaying <i>Zostera marina</i> with aufwuchs. Bacteria: <i>Arthro bacter</i> sp., <i>Pseudomonas</i> sp., <i>Vibrio</i> sp., <i>Flavobacterium</i> sp. Dinoflagellates. Faeces and pseudofaeces of bay scallop	Sediment dispersed in filtered estuarine water	20 to 25	ca 30	TIETJEN (1967)	

Table 5-37—Continued

Species	Medium	Food source	Temperature (°C)	Generation time (days)	Life span (days)	Author
<i>Oncholaïmus brachycercus</i>	Sea water (32‰S)	Aufwuchs on small pieces of <i>Laminaria</i> sp.	7	399	—	GERLACH and SCHRAGE (1972)
<i>Oncholaïmus</i> sp.	Brackish-water (15‰S) agar	Cornmeal	33	23 (average)	—	HOPPER and co-authors (1973)
			30	20		
			24	29		
			21	39		
			18	86		
<i>Panagrellus</i> sp.	Brackish-water (14‰ sea water)	Sterile wheat grains and <i>Escherichia coli</i>	25	—	—	KAHAN and APPEL (in press)
<i>Rhabdittis marina</i>	Marine nutrient agar Media 9 and 10 (Table 5-9)	Bacteria: <i>Micrococcus</i> sp., <i>Pseudomonas</i> sp., <i>Flavobacterium marinum</i>	25	5	—	TJETJEN and co-authors (1970)
<i>Rhabdittis marina</i>	Brackish-water (15‰S) agar	Cornmeal	35	1.75 (average)	—	HOPPER and co-authors (1973)
			33	1.5		
			30	2		
			24	2-25		
			21	2.5		
			18	4		
			12	8		
<i>Theristes portuensis</i>	Sea-water (32‰S) agar with KILLIAN nutrient solution	Aufwuchs: bacteria, fungi, diatoms, ciliates	17 to 22	23	—	GERLACH and SCHRAGE (1971)
			13 to 15	41		
			9 to 12	47		
			7	71	208 (females)	

substratum for attachment; others prefer or require rough surfaces (e.g. roughened glass or wood). More problematic to cultivate are species that develop normally only on seaweeds. Deterioration of, or changes in, the seaweed substratum may cause difficulties. Only few studies on substrate selection and substrate-bryozoan interrelationships have been conducted (RYLAND, 1959, 1962; RYLAND and STEBBING, 1971; NORTON, 1973). Detailed analyses of substrate requirements and studies on the effects of physico-chemical substrate properties remain to be performed. Several recent investigators (e.g. SCHNEIDER, 1955, 1959, 1963; HAUENSCHILD, 1962; KAISSLING, 1963; JEBRAM, 1968, 1970, 1973) have employed culture methods that are, in principle, similar to the technique originally introduced by GRELL (unpublished).

For subcultures and experimentation, secondary bryozoan colonies can be obtained by cutting off portions of a primary colony (analogous to the techniques described for colonial hydroids by KINNE, 1956, 1958). Cut-off colony portions consisting of one or several individuals reconstitute new colonies. From erect colonies, branches can be cut off without difficulty. From encrusting forms grown on a hard substratum, portions must be carefully sliced off (e.g. by razor blade); if grown on soft substrata such as seaweeds or plastic material, colony and substratum can be cut into suitable pieces without detachment. Some experimental ecologists have grown bryozoans on pieces of glass kept close together by a frame or by slit pieces of polyvinyl tubing (e.g. JEBRAM, 1968) during growth; these substrate pieces are later dissembled and yield appropriate portions of secondary colonies.

Resting buds ('hibernacula') have been reported in a variety of limnic bryozoans, and—more recently—also in *Bowerbankia gracilis* (BRAEM, 1951; JEBRAM, 1969), *Arachnidium hippothoides*, *Valkeria uva* and *Bowerbankia imbricata* (JEBRAM, in press). Culture experiments conducted by JEBRAM revealed that resting-bud formation is primarily a consequence of malnutrition. In all species examined, resting buds are of the same colour as eggs and embryos, presumably due to the colour of stored reserve materials, which—in turn—depend on the food taken up. JEBRAM described the development of zooids from resting buds under laboratory conditions. Resting buds are ecologically important as life-cycle stages characterized by reduced activity and increased resistance to environmental stress.

Attempts to cultivate marine bryozoans date back to PROUHO (1890), KUPELWIESER (1906), ZSCHIECHE (1909), HASPER (1912) and MARCUS (1926) who were primarily interested in physiological and morphological studies. HENTSCHEL (1916) and FRIEDL (1925) were the first investigators to employ bryozoan *in situ* cultures for studying aspects of settlement, metamorphosis and growth.

In a detailed, first review on marine bryozoans, GRAUPNER (1933) discusses techniques of collection and transportation, as well as methods of cultivation both under laboratory and *in situ* conditions. At that time, species of *Alcyonidium*, *Bugula*, *Crisia*, *Electra*, *Farella*, *Flustra*, *Lepralia*, *Membranipora*, *Myriozoon*, *Retepora*, *Schizoporella* and *Scrupocellaria* had already been kept under aquarium conditions. The diets offered consisted of undetermined, unicellular green algae, diatoms and peridineans (species of *Pleurococcus*, *Nitzschia*) and fine-particulate artificial fish food 'Piscidine 000'. The latter may have been effective both as fertilizer and/or direct food source. Small quantities of 'Piscidine 000' were either spread

on the surface of the culture water or emulsified with sea water; small amounts of the emulsion were then added to the aerated culture medium. The fine particles remained in suspension for long periods and served over months as food source for most of the bryozoans listed above.

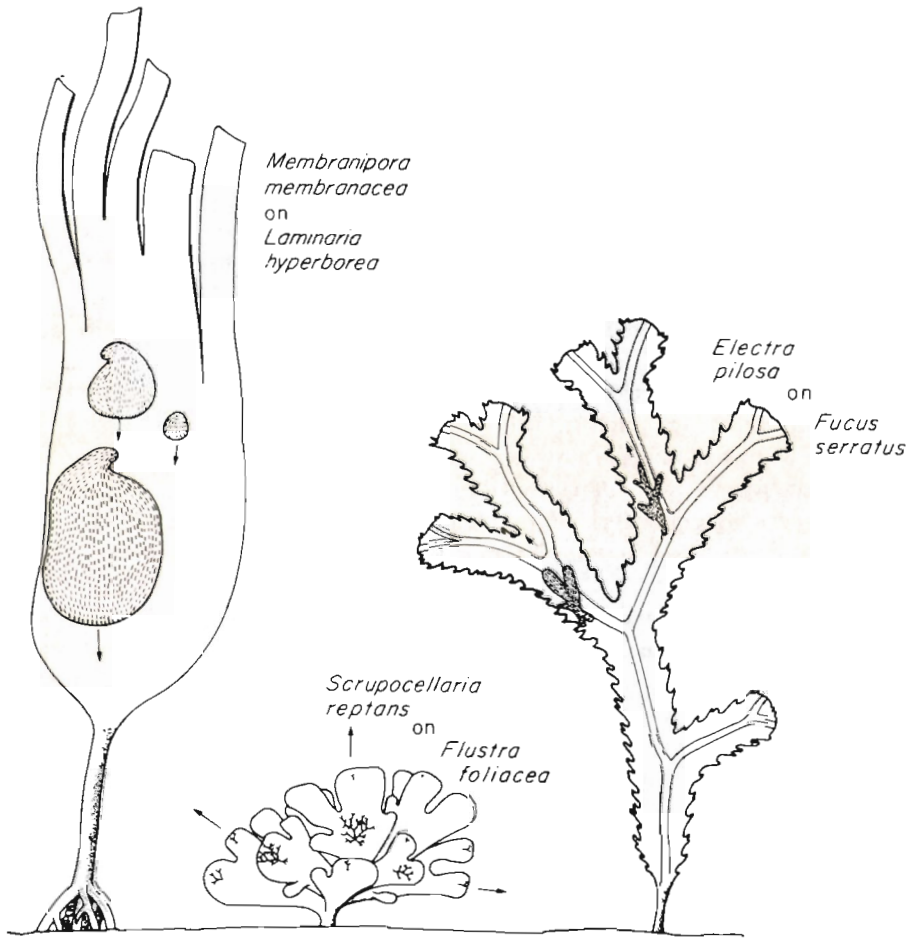

Fig. 5-21: Directional colony growth of the bryozoans *Membranipora membranacea*, *Scrupocellaria reptans* and *Electra pilosa* on their seaweed substrata. Arrows indicate predominating growth directions. (After RYLAND and STEBBING, 1971; modified; reproduced by permission of Cambridge University Press.)

Commenting on water-quality requirements, GRAUPNER (1933) points out that the resistance of bryozoans to changes in water properties varies considerably in different species. While off-shore species tend to be quite sensitive, intertidal forms may exhibit surprising tolerances. In the Zoological Institute at Leipzig, *Flustrella hispida* survived in sea water that had been recirculated for 14 years; due to rust and dirt, the water had acquired a brownish colour; it was kept at about 32‰ S by regular addition of tap water. According to GRAUPNER, *F. hispida* developed just as well as in this 'medium' as in newly collected North Sea water.

Most North Sea bryozoans seem to grow and develop best in dim light (see also LYNCH, 1947, and AYMES, 1956), at temperatures between 17° and 21° C and in salinities between 30 and 35‰. They require well-aerated water. Experimental substrata which have been used include collodium-covered culture dishes (PROUHO, 1890), glass (KUPELWIESER, 1906), paraffin (ZSCHIECHE, 1909), hen egg shells (HASPER, 1912), silk threads (MARCUS, 1926), slates (HENTSCHEL, 1916), or wood (FRIEDL, 1925).

Of the potential 'enemies' of bryozoans, the early investigators were particularly concerned with turbellarians, syllid polychaetes, nematodes and related forms that are difficult to prevent from entering non-filtered flow-through cultures. Larger forms, such as molluscs, echinoderms or fishes, may play an important role in *in situ* cultures. The importance of micro-organisms remains to be investigated.

Directional colony growth has been reported for the cheilostomate bryozoans *Membranipora membranacea*, *Scrupocellaria reptans* and *Electra pilosa* by RYLAND and STEBBING (1971): (i) Ancestrula larvae of *M. membranacea* tend to face basally on *Fucus serratus*; such orientation could not be detected on *Laminaria hyperborea*. *E. pilosa* ancestrulae tend to face distally on *F. serratus*. (ii) Whatever the initial larva orientation, colony growth in *M. membranacea* is directed towards the base of the algal frond (Fig. 5-21). In *S. reptans*, on *Flustra foliacea* distally directed colony growth predominates, but not on *Laminaria digitata* or *L. saccharina*, where the colonies are directed randomly. *E. pilosa* on *F. serratus* grow distally.

RYLAND and STEBBING (1971) conclude that not a single environmental factor, but several factors acting in concert, appear to control the prevailing colony growth direction. Water flow direction and light could act as stimuli for larva settlement. Directional colony growth in *Membranipora membranacea* may be a rheopositive response although age-dependent polarity in the substrate plant cannot be ruled out. On *Laminaria* fronds, *Scrupocellaria reptans* settles preferably on the youngest part. Life expectancy is here maximal and competition minimal.

Studies on directional growth of *Membranipora membranacea* on the large brown seaweed *Saccorhiza polyschides* (NORTON, 1973) revealed that, on average, 60% of the colonies grow proximally along the main axis of the plant substratum, irrespective of the plant region or their proximity to the primary meristem. These results seem to rule out substratum-age-dependent polarity, suggested as a possible directional cue by RYLAND and STEBBING (1971).

In most bryozoans cultivated by SCHNEIDER (1959), directional growth of the colonies has been reported to depend on the direction of light. Zooid buds grow towards, rhizoid buds away from the light.

(a) Major Species Cultivated

Alcyonidium Species

Alcyonidium polyoum, *A. hirsutum* and other bryozoans (p. 718) were placed in aerated glass or Plexiglas containers of various sizes, usually in dim light at temperatures between 14° and 16° C and in salinities between 13 and 17‰S (JEBRAM, 1968). Every 3 to 4 days, JEBRAM freed the colonies from faeces and heavy bacterial

growth by gentle brushing; thereafter, he provided them with a new food suspension. The food consisted of the heterotroph dinoflagellate *Oxyrrhis marina* which, in turn, received suspensions of *Dunaliella* sp. or *Cryptomonas* sp.—grown in a sterilized and filtered nutrient solution consisting of sea water, 1000 cm³; NaNO₃, 100 mg; Na₂HPO₄ · 12H₂O, 20 mg; soil extract, 10 to 20 cm³. Addition of nutrient solution to bryozoan cultures results in eutrophication of the culture water; this may be tolerated by some bryozoans from brackish and polyhaline waters, but not by truly marine forms. Hence, it is advisable to separate the food organisms from their nutrient medium by centrifugation and to wash them in sterilized water of appropriate salinity before adding them to the bryozoan cultures. Good growth and attainment of sexual maturity were obtained only in *A.* sp.

Bugula Species

Phototropic growth and colony structure of *Bugula avicularia* have been studied by SCHNEIDER (1955, 1959, 1963) and KAISLING (1963).

During the breeding season, larvae of *Bugula flabellata* are released by the parent colonies at dawn (GRAVE, 1937a). To obtain large numbers of larvae, GRAVE collected sexually mature colonies late in the afternoon and placed them in dishes of sea water. The dishes were left overnight near a window. In the early morning, masses of larvae were liberated and promptly swam to the lighted side of the dish. From here they can be pipetted to culture dishes (e.g. finger bowls). The larvae have no digestive tract and require no food. After about 6 days, they attach themselves to the walls of the culture enclosure and develop into colonies. Upon attachment, GRAVE placed his bryozoans in running, unfiltered sea water. He gives neither details on the food organism contained in the sea water nor on water temperature.

The first individual of a colony becomes a feeding polypide within 2 days and a colony of 8 individuals forms in 1 week. Under natural conditions, the colonies bud rapidly, attain sexual maturity in about 1 month, and continue to grow for about 3 months. This is the approximate life span of colonies established early in summer. Colonies grown in late summer over-winter. The transfer of laboratory cultures to *in situ* conditions and the use of wooden crosses (of about 1 m length), to which colonies attach in the normal environment, have provided data on natural growth dynamics. Tied to a dock, the floating crosses did not capsize in storms.

Bugula turrita has the same life history as *B. flabellata*, but—according to GRAVE (1937a, p. 179)—develops in 'somewhat different situations' (no details provided).

Membranipora membranacea

Members of this species have been kept under laboratory conditions by GRÄFFNER (1933) and MENON (1972). The latter author conducted experiments on heat tolerance, as well as on growth rates and structural responses obtained at different temperature levels.

MENON (1972) used colonies that had grown under *in situ* conditions on *Laminaria hyperborea* or on Plexiglas slides (exposed to southern North Sea water during April and May). After transfer to the laboratory, the colonies were fed *Cryptomonas* sp. The cultures were accommodated in glass vessels containing 4 to 5 l of aerated,

Millipore-filtered ($0.22 \mu\text{m}$) sea water of 32‰S and exposed to dim light. Each glass vessel received 250 cm^3 of a *Cryptomonas* culture ($15,000 \text{ cells ml}^{-1}$) once every 7 days. Maintained at different temperature levels (6° to 22°C), the culture water was changed every week. The growth rates obtained are illustrated in Fig. 5-22.

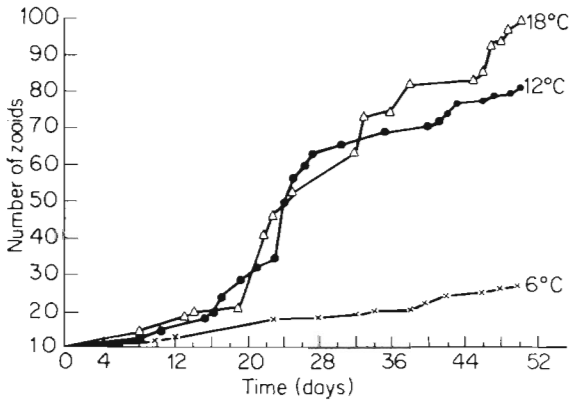

Fig. 5-22; *Membranipora membranacea*. Growth rates expressed as increase in zooid number of 5 initial rows of zooids exposed to three different temperature levels. (After MENON, 1972; reproduced by permission of Springer-Verlag.)

Zoobotryon verticillatum

BULLIVANT (1968) maintained *Zoobotryon verticillatum* in plastic buckets containing aerated sea water of 23° to 25°C . *Phaeodactylum tricornutum*, *Dunaliella tertiolecta*, *Eutreptia marina*, *Cricosphaera carterae* and *Monochrysis lutheri* were used as food algae (uni-algal, non-bacteria-free cultures). Concentrations of algal suspensions were determined with a Model A Coulter Counter.

Apparently, the Coulter Counter electrodes affected the quality of the suspension: in algal suspensions exposed to the electrode, zooids took longer to emerge than usual. In view of the wide use of Coulter Counters in cultivation, this finding is alarming; it requires further investigation.

Avoiding the source of error, BULLIVANT (1968) found that *Zoobotryon verticillatum* clears suspensions of the four first-mentioned food algae at rates ranging from 0.15 to $1.05 \text{ ml per zooid hr}^{-1}$ (13.9 – $96.2 \text{ ml mg}^{-1} \text{ dry weight hr}^{-1}$), when the algal suspensions are below satiation concentrations and maximum clearance rates could be expected. Satiation concentrations are comparable to the highest concentrations of nanoplankton in the bryozoan's natural habitat. Suspensions of the small flagellate *Monochrysis lutheri*, on which the bryozoans grew well, are cleared below the satiation concentration of $7900 \text{ cells ml}^{-1}$, at the mean rate of $0.37 \text{ ml per zooid hr}^{-1}$ ($33.7 \text{ ml mg}^{-1} \text{ dry weight hr}^{-1}$). The colonies of *Z. verticillatum* fed fairly constantly over a 48-hr period.

(b) Other Species

The bryozoans *Bugula neritina*, *Aetea* sp., *Bowerbankia caudata*, *Crisia* sp., *Lichenopora* sp., *Membranipora* sp., *Porella* sp., *Schizoporella sanguinea*, *Scrupocellaria reptans* and *Tubulipora* sp. have been cultivated by SCHNEIDER (1959) in Boveri dishes of 6 to 10 cm diameter, covered by a glass lid. The dishes contained non-aerated stagnant sea water maintained at about 20° C. Renewal of sea water and feeding (flagellate *Oxyrrhis marina* or smaller forms) was carried out daily or at intervals of a few days. The cultures were exposed to light conditions that supported appropriate growth of associated algae. Established dishes maintained a 'biological balance' between culture partners (bryozoans, bacteria, algae, protozoans, rotifers, nematodes, etc.).

Under conditions parallel to those described for *Alcyonidium polyoum*, *A. hirsutum* and *A.* sp. (p. 715), JEBRAM (1968) obtained good growth and sexual maturity (for periods of up to 3 years) in *Bowerbankia gracilis*, *Bugula stolomifera*, *Conopeum reticulatum*, *C. seurati*, *Electra crustulenta*, *E. monostachys*, *E. pilosa* and *Farella repens*. *Cryptosula pallasiana* was cultured with less success. The following species were maintained only for a short period, and some of them grew rather poorly: *Bowerbankia imbricata*, *Cribrilina punctata*, *Electra posidoniae*, *Escharella immersa*, *Hippothoa hyalina*, *Microporella ciliata* and *Tubulipora* sp.

Conopeum reticulatum and *Electra pilosa*, maintained in darkness, were cultivated under conditions similar to those employed for *Membranipora membranacea* (p. 716) by MENON (1972). In a later study, MENON (1974) determined in these two species clearance rates of food suspensions (*Cryptomonas* sp.) and food passage as a function of temperature.

The effects of food quantity and food quality on growth and structural differentiation have been studied by JEBRAM (1973) in several bryozoans. Zooid size attains maximum values in the presence of suitable amounts and kinds of food organisms, but decreases under non-optimal nutrient conditions (e.g. various species of *Alcyonidium*, *Conopeum seurati*, *Farella repens* and *Triticella koreni*). *Farella repens* exhibit slow vegetative growth and do not mature sexually when fed *Monochrysis lutheri*; reduced growth of zooids and slow or no attainment of sexual maturity is obtained with *Oxyrrhis marina* as food organism; rapid growth of stolons and zooids and regular attainment of sexual maturity results from feeding with *Cryptomonas* sp. *Bowerbankia gracilis* exhibit rapid growth of long stolons with comparably few zooids and mature sexually when offered *Monochrysis lutheri*; with *Cryptomonas* sp. as food, *B. gracilis* and *B. imbricata* mature, but stolonial growth remains slow. Other structures that may change as a function of nutrition and/or environmental factors are tentacle number and colony growth pattern.

The mechanism of suspension feeding employed by *Bugula* sp., *Membranipora villosa* and *Schizoporella unicornis* has received attention from STRATHMANN (1973). Employing suspensions of the algae *Dunaliella tertiolecta* and *Cricosphaera carterae*, and light microscope as well as scanning electron micrograph techniques, STRATHMANN postulates that local reversal of lateral cilia beat facilitates concentration and capture of the suspended food particles. The reversal is presumably induced by particles contacting either the lateral cilia themselves, or upstream sensors (e.g. latero-frontal bristles or latero-frontal cilia). Mucus strands are not used.

(c) Bryozoa as Assay and Food Organisms

No published information has come to the reviewer's attention that would allow assessment of the potential role of bryozoans as assay or food organisms.

It seems feasible to expose colonies grown under known environmental and nutritive conditions, together with their substratum, to *in situ* conditions and to assess water quality by comparing survival, colony growth, reproduction and structure obtained in culture, in the test habitat and in a control habitat.

The importance of bryozoans as food organisms for other cultured animals is likely to remain restricted to a few specialized bryozoan feeders and to bryozoan larvae.

(d) Bryozoa: Conclusions

After a pause of several decades, early studies on cultured bryozoans have been succeeded by new interest in this small invertebrate phylum. While most of the early investigations had been stimulated by physiologists and morphologists, modern culturists have placed more emphasis on ecological aspects such as substratum selection, rate and directivity of growth, reproduction, nutrition and life cycle. Initial insights have been gained into bryozoan performance under different, controlled environmental conditions, but much remains to be done before we possess an adequate fundament for assessing the effects of environmental variation and of different diets on functional and structural performance.

The larvae of most bryozoans do not feed prior to metamorphosis. This facilitates cultivation and restricts nutritional studies to colonies. A variety of small phytoplankters, notably green algae, diatoms and peridineans, have been found in the intestinal tracts of nature-grown bryozoans and have been used as food sources in culture experiments. Examples of food organisms offered to cultivated bryozoans are *Cricosphaera carterae*, *Cryptomonas* sp., *Dunaliella tertiolecta*, *Eutreptia marina*, *Monochrysis lutheri*, *Nitzschia* sp., *Oxyrrhis marina* and *Phaeodactylum tricoratum*. Not all of these food sources are entirely satisfactory. We need more detailed information on nutritional requirements of bryozoans, both in terms of quality and quantity, and more knowledge regarding the food actually consumed under *in situ* conditions. Presumably, also small detritus particles and bacteria are consumed. The use of fine-particle artificial food ('Piscidine 000') yielded promising results and deserves further investigation.

Change-over from one type of food organism to another may cause active polypides to undergo reduction, and, subsequently, initiate the formation of new polypides. JEBRAM (1968) assumes that sudden changes in the food source require parallel changes in the physiology of digestion which can be brought about only in young polypides. Lacking sufficient plasticity, old polypides must be absorbed. Such non-genetic (acquired) food specificity of fully grown polypides may well have been the reason for poor growth or high mortality in some of the bryozoan colonies sustained under laboratory conditions.

Of special importance is the provision of a suitable substratum to settling larvae. Several species display pronounced substrate specificity. In addition, water movement, adequate oxygen supply, fast and efficient removal of metabolites from the culture water, and a certain constancy of environmental and nutritional conditions

are important prerequisites for the successful cultivation of stenoplastic forms. Attempts to cultivate bryozoans in artificial sea water and under axenic conditions remain to be made.

Essential steps in Bryozoa cultivation are: (i) collect newly liberated larvae from mature parent colonies, e.g. by employing a light trap; (ii) pipette the larvae into a suitable culture enclosure, e.g. Boveri dish or Petri dish (Fig. 2-23, p. 58); since most bryozoan larvae have no alimentary canal, no feeding is required prior to metamorphosis; (iii) provide a suitable substratum for setting larvae, e.g., glass slide, plastic material, or pieces of *Laminaria* sp.; (iv) transfer substratum plus attached larvae to small running sea-water systems similar to that illustrated in Fig. 2-156, p. 242, and add food; (v) control essential environmental factors, such as light (dim light or darkness is usually preferred), temperature and salinity, as well as the concentrations of life-endangering substances (Chapter 2, p. 79–p. 100).

Water quality, water-flow direction, illumination and substratum appear to control larvae setting. Colony growth pattern and directionality seem to depend primarily on bryozoan-substratum interrelationships, water movement, light direction and nutrition.

As in other animals, structural peculiarities may develop in cultured bryozoans that have never been seen under natural conditions. Similar to the functional potential, the structural potential of a given species may be larger under optimum culture conditions and in the absence of competition and/or predation than under normal field conditions. Apparently, most structural deviations and abnormalities revealed in culture are combined with reduced potentials for survival, reproduction and competition in the natural environment.

(9) Annelida

Segmented worms with a coelomic perivisceral cavity, a prostomium and trochophore- (trochosphere-) type larvae, the Annelida are represented in marine environments primarily by the large class Polychaeta; most of the Oligochaeta and Hirudinea inhabit fresh waters or moist terrestrial habitats.

(a) Polychaeta

Polychaetes are nearly always dioecious, with gonads extending throughout the body, external fertilization, and a free-swimming trochophore larva. Most investigations that involve cultivation of marine polychaetes are devoted to morphological, physiological, genetical or biochemical rather than ecological problems. Hence, restriction is necessary in the selection of papers to be reviewed here.

Arenicola marina

The lugworm *Arenicola marina* inhabits sandy shores of the northern Atlantic Ocean, often at very high population densities. In a mixture of sand and mud, *A. marina* can be cultured without much difficulty. However, unless accommodated between narrowly spaced glass plates or in glass tubes, observation remains a problem. Using U-shaped glass tubes simulating the natural burrow, WELLS (1945,

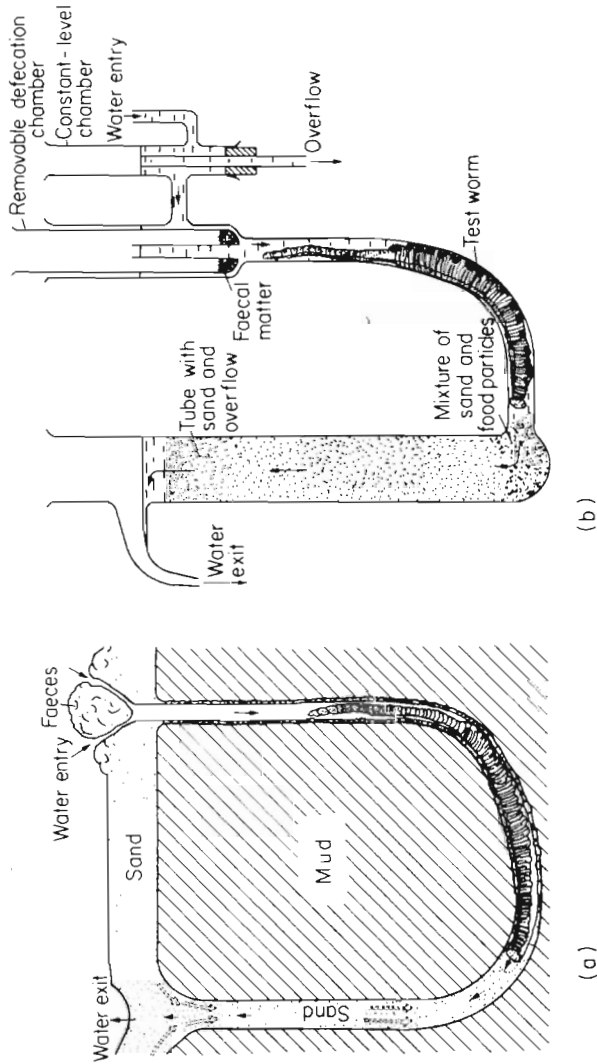

Fig. 5-23. *Arenicola marina*. (a) Schematic view of natural burrow. (After KRÜGER, 1959; modified; reproduced by permission of Akademische Verlagsgesellschaft Geest and Portig.) (b) Culture container of glass, facilitating observation and experiments on rates of pumping, respiration, defecation and feeding. Arrows indicate water-current direction. (After KRÜGER, 1962; modified; reproduced by permission of Walter G. Mühlau.)

1949) and KRÜGER (1958, 1959, 1962, 1964a, b) cultured *A. marina* over several weeks and studied behaviour, activity, respiratory rates or aspects of nutrition (Fig. 5-23a, b). In KRÜGER's culture enclosure, the lugworm defecates through the narrow central tube inside the defecation chamber; this facilitates removal of faecal matter which would otherwise tend to clog the posterior tube section. According to KRÜGER (1959, 1962), the worm ingests primarily the sand in the initial, lower portion of the sand column in its U-shaped tube. As the worm forces a water current through its tube, the initial sand-column section acts as filter. Employing red carmine suspensions, KRÜGER (1959) could demonstrate that the material retained in the sand is indeed eaten. He has summarized his work on *A. marina* in a paper published in 1971.

Testing a variety of potential food sources, KRÜGER (1962) reports that *Arenicola marina* stops pumping when offered unsuitable nutrients. Unicellular algae such as *Chlorella* sp. and algal detritus seem to represent acceptable food. Illumination tends to inhibit feeding, but not pumping. *A. marina* appears to feed selectively. It rasps off single sand grains with the papillae on its pharynx. However, only selected sand grains are ingested; the others are dropped. Sand grains larger than 2 mm diameter are rarely swallowed. Sand-grain size and chemical stimuli are assumed by KRÜGER to represent key factors in the nutritional selectivity observed.

KRÜGER (1964b) determined pumping rates of *Arenicola marina* also under *in situ* conditions. At about 18° C, worms of 10 to 15 g wet weight produce a water current at the entry of their burrow of 120 to 200 ml hr⁻¹. *In situ* studies on pumping rates of *A. marina* are facilitated by the 'Stechkasten' (ZIEGELMEIER, 1964).

In British waters, *Arenicola marina* reproduces in autumn (NEWELL, 1948, 1949), releasing eggs which have a higher specific weight than sea water, and hence, remain on or near the sea bottom. The larvae (about 0.24 mm) have, in contrast to most other polychaetes, no pelagic phase; they live near the bottom where they overwinter. In the following spring, the post-larval stage is attained (about 3 mm). Except for the lack of gills, the postlarva features all typical characteristics of the adult worm. The smallest individuals found in U-shaped tubes measured 8 mm.

Adult *Arenicola marina* are not as sedentary as often assumed. They have been found in the plankton. There is evidence (discussed by WERNER, 1954a, b) that unsuitable environmental conditions (e.g. rapid temperature decrease in winter) cause large numbers of lugworms to leave their tube and to migrate to more acceptable places. S-shaped, with head and tail swinging simultaneously in opposite directions, *A. marina* swims backwards. Leading the way, the tail end of a swimming individual is much thicker than normal (VON BUDDENBROCK, 1953, p. 164; WERNER, 1954b). Further important contributions to the ecology of *A. marina* have been presented by THAMDRUP (1935) and WELLS (1963, 1964).

Autolytus prolifer

Collected near Sylt (North Sea), *Autolytus prolifer* has been cultivated for 2 years (5 generations) in sterilized North Sea water by HAUENSCHILD (1959c). The worms were kept initially in Boveri dishes (30 to 40 individuals per dish), later (after attaining 15 to 20 segments) in larger crystallizing dishes. They received hydroids (*Laomedea flexuosa* and *Campanularia johnstoni*) as food.

The larvae hatched after 4 days; their first food consisted of hydrorhiza contents; only after full development of the pharynx apparatus did the young worms begin to eat hydranths. Within 2 to 3 months, they attained sexual maturity (about 40 segments) and began to bud (over several months) sexual individuals at their posterior end.

Brania (Grubea) clavata

Brania clavata were cultivated in sterilized North Sea water at 20° C (HAUENSCHILD, 1953, 1959b). Young individuals with less than 15 segments were kept in Boveri dishes (up to 40 specimens per dish). Older worms tend to kill each other and hence had to be kept separately (small dishes of 4 cm diameter).

All *Brania clavata* were transferred once or twice a week into new sea water and fed, at 1- or 2-day intervals, drops of a suspension consisting of dinoflagellates (*Oxyrrhis* sp.) and some 'Piscidine 000' (commercial pet-fish food). One female produces on average 20 to 30 (maximal 72) eggs, which are carried on the back until hatching. Over 2 years, a total of 7 generations (2339 individuals) was obtained (HAUENSCHILD, 1959b).

Capitella Species

Capitella capitata, collected near Kiel (FRG), have been maintained by AUGUSTIN and ANGER (1974) in culture containers (36 × 18 × 23 cm deep) with a 4-cm layer of sea sand. The culture water (10° C, 15‰S) was aerated. If given a choice, the worms preferred *Mytilus edulis*, turf and *Zostera marina* to the sand substratum. Copulation, oviposition and early ontogenetic development proceeded exclusively within the tubes.

Capitella sp., an inhabitant of bottom detritus of Florida mangrove swamps has been sustained in disposable plastic Petri dishes (9 × 1.5 cm deep) containing a 3- to 8-mm thick layer of gel made from cornmeal agar rehydrated with sea water (GEORGE, in press). Pure cultures were less viable than those with natural contaminant organisms such as ciliates and nematodes. No decrease in vitality has been detected over a 3-year period. According to GEORGE, a minimum amount of attention is needed to sustain non-pure cultures; sometimes, it was possible to seal the Petri dishes and to leave them unattended for periods of up to 3 months, depending on the quantity of cornmeal agar and the number of individuals present. In translucent agar layers, observations on behaviour and life history have become possible. The harpacticoid copepod *Heterolaophonte* sp. has been sustained successfully under identical conditions, and other deposit feeders are now being introduced to laboratory cultures using the same technique.

Eunice viridis

The Pacific palolo worm *Eunice viridis* was maintained up to several months under laboratory conditions in culture dishes with habitat water (HAUENSCHILD and co-authors, 1968). The culture conditions (no details provided) were obviously inadequate. The complete palolos grew only few additional segments and frequently

autotomized the new segments grown. Headless fragments of palolos survived under laboratory conditions for months and regenerated.

Hydroides Species

A serpulid, *Hydroides dianthus* secretes a calcareous tube and attaches it firmly to solid substrata such as stones, mollusc shells or wood. Near Woods Hole (Mass., USA), *H. dianthus* breeds between June and October (GRAVE, 1937c). GRAVE obtained ova or spermatozoa after removing the worms from their tubes and placing them singly in dishes or Syracuse watch glasses filled with sea water. After such treatment, they spawn immediately if sexually mature.

Quite immobile upon release, the spermatozoa require some time for activation. GRAVE (1937c) recommends adding a sea-water—spermatozoa mixture to the eggs about 60 mins after spawning. Following fertilization, the eggs develop within 10 hrs (no temperature given) into swimming gastrulae. They may now be poured into a clean culture dish, discarding all eggs which failed to develop. Within 24 hrs, the embryos have grown into transparent trochophore larvae, which continue to swim about in the water. Showing little externally visible change—except a slight slender outgrowth at the posterior end (the beginning of the worm body)—the trochophores keep swimming about (10 to 14 days) feeding on diatoms by means of a ciliary mechanism. Using aquarium jars, ZELENY (1905) has raised such larvae to metamorphosis.

Finally, the trochophore's body becomes slender. After permanent settlement, a calcareous tube is secreted. Under adequate conditions, *Hydroides dianthus* matures sexually after 7 or 8 weeks, and becomes fully grown in 2 years. After 1 year's growth, the tube of an average-sized worm measures 65 to 70 mm in length and 3 or 4 mm in maximum diameter (GRAVE, 1937c).

Collected near Naples (Italy) and Plymouth (England), the tube builder *Hydroides norvegica* developed well in natural and artificial sea water* (LUDWIG and LUDWIG, 1954). Avoiding algal overgrowth, the cultures were fed *Dunaliella salina*. For over 1 year, worms from Naples were kept at temperatures between 19° and 25° C, those from Plymouth, between 17° and 22° C. For attachment, the larvae received glass plates, bivalve shells, stones or pieces of porcellain. However, the trochophores did not settle.

The serpulid polychaetes *Hydroides norvegica* and *H. uncinata* have been cultured in finger bowls at 24° C, using unicellular green algae as food for pelagic stages and diatoms *Navicula praetexta* for young worms (VUILLEMIN, 1968; see also ZELENY, 1905; RULLIER, 1955; SENTZ-BRACONNOT, 1964). WISELY (1958) reared *H. norvegica* larvae to settling in 8 to 10 days at 20° C in beakers filled with sea water (food: *Dunaliella tertiolecta*). The larvae continued feeding throughout metamorphosis. Literature concerned with regeneration in polychaetes has been reviewed by HOFMANN (1966). *Polygordius* larvae have been reared by COWLES (1903), serpulid larvae by ZELENY (1905), larvae of *Armandia cirrosa* by GUÉRIN (1973). Pigment deficiency in a mutant of *Platynereis dumerilii* found in a laboratory stock has been reported by FISCHER (1969). Under laboratory conditions, larvae of

*Zoologische Station, Buisum, FRG.

Ophelia bicornis could be induced to settle by the presence of micro-organisms (defined quantity of certain species) in the substrate offered (WILSON, 1952, 1953a, b, 1954, 1955).

Lanice conchilega

This tubicolous polychaete has been sustained under culture conditions by WATSON (1890), SEILACHER (1951), ZIEGELMEIER (1952, 1969a, b), KESSLER (1963) and BUHR (in press). KESSLER used glass enclosures ($20 \times 20 \times 50$ cm deep) filled half with well-washed sediment and half with sea water (aeration; 5.7° – 10.3° C; filtered sea water) to allow newly caught, mature adults to release, in pairs, their gametes. She succeeded in raising larvae in unfiltered sea water (no additional feeding) and described the larval development. ZIEGELMEIER (1969a) maintained adult *L. conchilega* in a small laboratory stream (Fig. 2-115b, p. 204) on freshly homogenized meat of *Mytilus edulis* added drop-wise to the culture water near the polychaetes' tentacles. ZIEGELMEIER provided a detailed account on tube-building activities. BUHR kept his *L. conchilega* at 12° C and 27 to 28‰S in washed, sterilized (110° C) medium and coarse sand, and fed pure cultures of *Dunaliella marina*. He studied suspension feeding of adults and determined assimilation efficiencies. The amounts of food retained from the algal population (40×10^6 cells l^{-1}) and the assimilation efficiencies calculated parallel known values typical for obligatory suspension-feeders. This fact suggests that *L. conchilega*, which is also known to deposit-feed (e.g. BLEGVAD, 1914; HUNT, 1925; REMANE, 1940; YONGE, 1949), can cover its nutritional requirements solely by suspension feeding (see also HAGMEIER and KÄNDLER, 1927; HAGMEIER, 1951).

Mercierella enigmatica

A subtropical cosmopolitan filter feeder, the brackish-water-living serpulid polychaete *Mercierella enigmatica* can be kept with ease under laboratory conditions. DIXON (in press) offered estuarine unicellular algae (*Brachiomonas submarina*) as food (maximum concentration: 3.88×10^4 cells ml^{-1}). Worms sustained in culture water containing algal cells at maximum concentration exhibited normal feeding behaviour. The somatic tissue of the polytelic and protandrous hermaphrodite *M. enigmatica* has a mean calorific value of 4.32 cal mg^{-1} dry weight (4.1 in males and 4.4 in females); the values for eggs and spermatozoa are 4.5 and 3.8 cal mg^{-1} , respectively.

Nereis Species

Even though preferences for either animal or, less frequently, plant food may prevail, most *Nereis* species examined are omnivorous. They take up a large variety of micro- and macro-organisms, detritus, and in several cases have been shown to accumulate ambient dissolved organic matter. Devoid of surface ciliation most nereids are burrowers and tube dwellers. Body undulations force a water current to pass through their tube. The discovery of a filter-feeding mechanism in *Nereis* (*Hediste*) *diversicolor* (HARLEY, 1950) and in related forms requires attention in culture experiments (see also below).

Nereis agassizi and *N. procera* have been reared from egg to maturity by GUBERLET (1934a, b, 1937). Fertilized eggs were obtained in a way similar to that described for *Nereis limbata* (see below). GUBERLET stresses the need to keep the temperature constant. He changed the culture water daily and agitated it at least once each day to provide aeration. As soon as the larvae develop setigerous appendages, jaws begin to grow and small diatoms (e.g. species of *Navicula* and *Nitzschia*) are readily consumed in large quantities. The larvae grow rapidly. After developing 6 or 8 segments, they form mucous tubes. With 10 or 12 segments, *Ulva* sp., brown kelp (*Nereocystis* sp.) and 'small worms' may be added to the diet.

Nereis (Hediste) diversicolor has been cultivated by BOGUCKI (1962). KINNE (unpublished; see also 1954) raised *N. diversicolor* at temperatures between 12° and 18° C and in salinities between 10 and 30‰ in aerated aquaria (30 × 30 × 30 cm) filled 20 cm high with sand. Maintained under dim light conditions (10 ft.c. at water surface), the worms received oligochaetes (*Enchytraeus albidus*, small *Lumbricus terrestris*) and small pieces of mollusc meat (*Mytilus edulis* foot or mantle tissue) as well as small pieces of garden lettuce, *Enteromorpha* sp. and *Ulva lactuca*. Partially leaving its tube, *N. diversicolor* searches the nearby substrate surface for food and draws larger food items into the tube (substrate-surface feeding); *N. diversicolor* is also capable of constructing a funnel filter in its tube which retains small suspended particles; from time to time, filter plus particles are consumed (filter feeding: HARLEY, 1950, 1953, 1956; GOERKE, 1966, 1971a). GOERKE (1971a) fed *N. diversicolor* pieces of Glyceridae, *Heteromastus filiformis*, *Anaitides maculata*, enchytraeids, tubificids, *Mytilus edulis*, nematodes, larval dipterans, *Cordylophora caspia*, beef and pork, as well as pieces of several algae: *Enteromorpha* sp., *Ulva lactuca*, *Plocamium coccineum* and *Porphyra umbilicalis*. *N. diversicolor* can also take up fine-particulate matter from the substrate surface. Gut-content analyses of wild *N. diversicolor* revealed protozoans (rhizopods), rotifers, nematodes, oligochaetes, gastropods, bivalve veligers, ostracods, copepods, amphipods, cumaceans, cladoceran eggs, larvae of chironomids and other dipterans, as well as cyanophyceans, peridineans, diatoms, *Scenedesmus*, *Pediastrum* sp., *Enteromorpha* sp., Chlorococcales, filamentous Chlorophyceae and parts of cormophytes (YABLONSKAYA, 1953), as well as foraminiferas, detritus and sand (e.g. SCHRÖDER, 1886; RAUSCHENPLAT, 1901; BLEGVAD, 1914; HERPIN, 1925; THAMDRUP, 1935; BOGUCKI, 1953; PERKINS, 1958; MUUS, 1967). Reproduction and development of *N. diversicolor* have received attention from BOGUCKI (1954).

For studies on salt and water balance, OGLESBY (1970) kept *Nereis (Hediste) diversicolor* in glass tubes of 2- to 3-mm diameter placed in small trays provided with glass tubing (artificial burrows) at temperatures of 10° C or between 14° and 18° C in a wide range of salinities. In this condition, the worms survived up to several months without feeding.

Nereis (Neanthes) fucata, a commensal of the hermit crab *Eupagurus karnivor*, has been kept in culture by GOERKE (1971a) and fed pieces of the following animals and plants: *Lanice conchilega*, *Mytilus edulis*, *Crepidula fornicata*, *Eupagurus bernhardus* (muscles and eggs), *Enteromorpha* sp., *Plocamium coccineum* and *Porphyra umbilicalis*. COUPIN (1894), CHEVREUX (1908) and BRIGHTWELL (1951) fed representatives of the genera *Buccinum*, *Cardium*, *Mytilus* and *Pecten*. GILPIN-BROWN (1959, 1969) raised juvenile *N. fucata* on *Oxyrrhis* sp. According to

GOERKE (1971c), juveniles normally appear to feed predominantly on detritus and micro-organisms.

GOERKE (1971c) conducted laboratory experiments on *Nereis fucata* (growth, secretion, orientation, food uptake, behaviour) in aquaria ($12 \times 17 \times 19$ cm; 1 individual aquarium⁻¹) at 4°, 8°, 10° and 16° C. *N. fucata* was kept together with its host, *Eupagurus bernhardus*, which received each week 5 *Lanice conchilega* as food. The faeces were removed weekly; at the same time, $\frac{1}{3}$ of the culture water was renewed. Although *N. fucata* can be cultivated in vertical glass tubes (GOERKE, 1966), the experiments were conducted with longitudinally sectioned *Buccinum undatum* shells covered with a transparent plate in order to facilitate observation of both crab and polychaete. In a few cases, *N. fucata* has been found free living on the sea bottom (e.g. HORNELL, 1891; MCINTOSH, 1910; HEINEN, 1911; NEWELL, 1954; KERNEIS, 1960); however, most records corroborate the close relationship between this polychaete and its host *E. bernhardus* (literature in: GOERKE, 1971b). In general, only one *N. fucata* lives together with one *E. bernhardus*. Potential secondary intruders are fought energetically by the original occupant.

Nereis (Nereis) limbata have been collected by a small dip net at night after allowing the worms to aggregate in artificial light (GRAVE, 1937b). Freshly caught *N. limbata* were placed in dishes of sea water. GRAVE separated females and males in order to avoid instant spawning. Near Woods Hole (Mass. USA), *N. limbata* usually spawns from full moon to new moon during the summer. According to GRAVE, ova and spermatozoa are released from 9 to 10 p.m., when females and males swim near the sea's surface and come into contact with each other.

For securing eggs, GRAVE (1937b) recommends selecting a ripe female with a distended body, placing her in a dish of clean sea water and cutting across her body, thus allowing the eggs to escape. In the same way, a ripe male is cut in two pieces in a separate dish. After washing the eggs once or twice (decanting the water and refilling the dish), 3 or 4 drops of sea water containing spermatozoa are added, and the resulting mixture gently agitated. Within 5 mins of insemination, the eggs extrude a jelly. Usually 100% of the eggs cleave and nearly all develop into normal embryos. During egg development, the water should be changed several times. After 24 hrs, the embryos may be separated from the jelly surrounding the eggs and transferred to a clean dish of sea water.

After about 36 to 48 hrs, trochophores had developed, and on the third day, the first 3 worm segments were completed. Trochophores and early segmented larvae are rather hardy and require no food during the first 5 or 7 days. They then settle on the bottom and should be transferred (using a wide-mouthed pipette) to fresh sea water once a day. Five days after the first settlement, they are fed diatoms. If transferred to cylindrical aquaria containing dense cultures of diatoms, *Nereis limbata* larvae may attain maturity. JUST (1922) has reared *Nereis megalops* to maturity in such diatom jars.

Cultivated *Nereis (Eunereis) longissima* have been fed by GOERKE (1971a): Glyceridae, *Heteromastus filiformis*, *Anatides maculata*, *Lanice conchilega*, enchytraeids, *Cordylophora caspia*, *Mytilus edulis* and harpacticoids, as well as pieces of the plants *Enteromorpha* sp., *Ulva lactuca* and *Plumaria elegans*. Stomach-content studies by HARLEY (1956) and GOERKE (1971a) revealed fine sand and detritus. Possibly, *N. longissima* is primarily a substrate and detritus feeder.

Nereis (Nereis) pelagica has been kept in culture for feeding experiments by GOERKE (1971a). He recorded the uptake of body pieces from the following animals and plants: Glyceridae, *Heteromastus filiformis*, *Eteone longa*, *Lanice conchilega*, enchytraeids, *Mytilus edulis*, *Cladophora rupestris*, *Enteromorpha linza*, *E. sp.*, *Ulva lactuca*, *Chordaria flagelliformis*, *Plocamium coccineum* and *Delesseria sanguinea*, as well as pieces of beef and pork. CLARK (1959, 1960) fed parts of *Mytilus edulis*, and WILSON (1932) raised juveniles of *N. pelagica* on *Nitzschia closterium*. Additional papers on feeding habits of *N. pelagica* have been authored by RAUSCHENPLAT (1901), BLEGVAD (1914), HERPIN (1925), VON BRAND (1927), BEKLEMISHEV (1950, 1953) and HARLEY (1956).

Nereis (Neanthes) succinea have consumed during laboratory feeding experiments (GOERKE, 1971a) pieces of *Lanice conchilega*, *Mytilus edulis*, *Crepidula fornicata*, *Enteromorpha sp.*, *Plumaria elegans* and *Delesseria sanguinea*. *N. succinea* also feeds on copepods (CORY, 1967), faeces of oysters (FRANKENBERG and SMITH, 1967), and mud, sand and detritus (HARLEY, 1956; STARK, 1959; McCLOSKEY, 1970).

The large omnivorous *Nereis (Neanthes) virens* feeds on a variety of algae, diatoms and invertebrates, including other polychaetes, as well as on detritus and sediment. In culture experiments designed to investigate the energy budget of *Nereis (Neanthes) virens*, KAY and BRAFIELD (1973) offered the polychaete *Nephtys hombergii* as food source. In 35- to 45-day experiments, each *Nereis virens* was kept in a glass tube of about 20 cm length, selected by the worm from a range of bores (if the tube bore is not acceptable to the worm, it will neither irrigate properly nor grow normally; WALSBY, 1970). Each tube was placed in circulating sea water, and sealed with a short glass tube of larger diameter, closed at one end in order to prevent *Nereis virens* from leaving its artificial tube, and in order to allow food to be offered, and faeces and excess food to be collected. The short covering tubes made it possible for the worms to create sufficient water movement in their tubes for respiration. Kept in darkness at 15°C, except when food was added or faeces were removed, the cultured *Nereis virens* exhibited almost normal feeding behaviour (KAY, 1972).

Nereis virens collects animal and plant food near its tube entrance with its eversible pharynx and then retracts the food into the tube (e.g. BARNES, 1963; GOERKE, 1971b). The food items taken up by *N. virens* include the following: sponges, platyhelminthes, annelids (e.g. *Nephtys caeca*, *Lanice sp.*, *Nereis sp.*, *N. diversicolor*), crustaceans (e.g. gammarids, isopods, mysids, copepods, cirripedes, *Carcinus maenas*, *Callinectes sapidus*, *Portunus sp.*), molluscs (e.g. young *Littorina littorea*, *Mytilus edulis*, *Mya arenaria*, *Cardium edule*) and young or moribund adult fishes, as well as detritus and sediment (e.g. VERRILL, 1873; TURNBULL, 1876; GROSS, 1921; COPELAND and WIEMAN, 1924; COPELAND, 1925, 1935; VON BRAND, 1927; HEMPELMANN, 1931; COPELAND and BROWN, 1934; LINDROTH, 1938; MINER, 1950; FÜLLER, 1961; KHLEBOVTCH, 1963; PETTIBONE, 1963; LEWIS and WHITNEY, 1968; GOERKE, 1971a). GOERKE (1971b) kept *N. virens* in vertically positioned, U-shaped glass tubes, with a diameter large enough to facilitate the body's dorso-ventral ventilation movement as well as U-turns of the worm within the glass tube. Three to 5 glass tubes containing one worm each were accommodated in one 5-l glass aquarium (experimental temperatures: 4°, 8°, 16° C; salinity: 20‰S).

Offering *Lanice conchilega* as only food source, GOERKE determined, in 28-week experiments, feeding rate, gross growth efficiency and growth rates.

Ophryotrocha Species

Collected near Naples (Italy), *Ophryotrocha labronica* was cultivated by ÅKES-SON (1970) for more than 50 generations without signs of decreased vitality. Stock cultures were kept in aquaria containing 3 to 5 l sea water of 32‰ to 34‰S at about 20° C (or at 15° C in order to retard rates of reproduction). The sea water was filtered and sterilized (heating to 80°–90° C) and renewed once or twice a week.

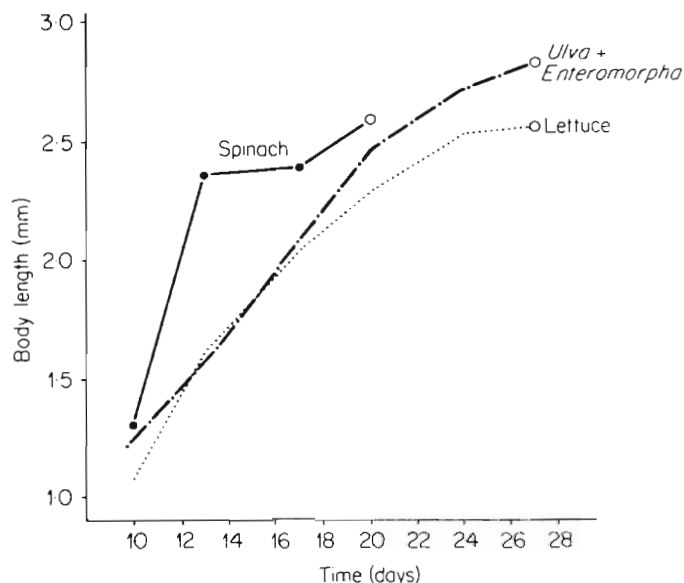

Fig. 5-24: *Ophryotrocha labronica*. Body length and oviposition of first egg mass (open circles) as a function of food source (powders made from frozen spinach, from pieces of *Ulva* and *Enteromorpha* species, and from lettuce leaves) and time. Mean values of 40 individual data. 20° C; 32 to 34‰S. (After ÅKES-SON, 1970; modified; reproduced by permission of Biologische Anstalt Helgoland.)

The food offered to *Ophryotrocha labronica* consisted of ordinary commercially available frozen spinach (washed, parboiled and cut before freezing). Spinach fragments were scraped from the frozen block and placed in sea water which was changed 3 to 4 times before the food was offered to the worms. Even freshly hatched larvae thrive on spinach; they may be fed, in addition, a mixture of *Nitzschia closterium* and a green flagellate (no details given). Living algae pieces (species of *Ulva* and *Enteromorpha*) are refused. However, after freezing and if offered in the same way as the spinach, these algae are accepted and the worms develop normally. Nutritional preferences are illustrated in Figs 5-24 and 5-25. The curves in Fig. 5-24 are based on approximately 75 larvae placed in each of 12 bowls, of which groups of 4 bowls received 3 different foods: powder made from (i) frozen commercial spinach;

(ii) lettuce leaves; (iii) frozen pieces of species of *Ulva* or *Enteromorpha*. Spinach gives best growth and earliest sexual maturity. The curves in Fig. 5-25 were obtained in a parallel experiment employing frozen spinach, an undetermined green flagellate, and living *Nitzschia closterium* as food sources. Again, spinach produces the best results. Comparable culture methods have been employed for *O. diadema* (see also ÅKESSON, 1976).

ÅKESSON (1970) considers 26° C the optimum temperature. At 28° C, growth is most rapid and reproduction almost normal, but mortality during early embryo-

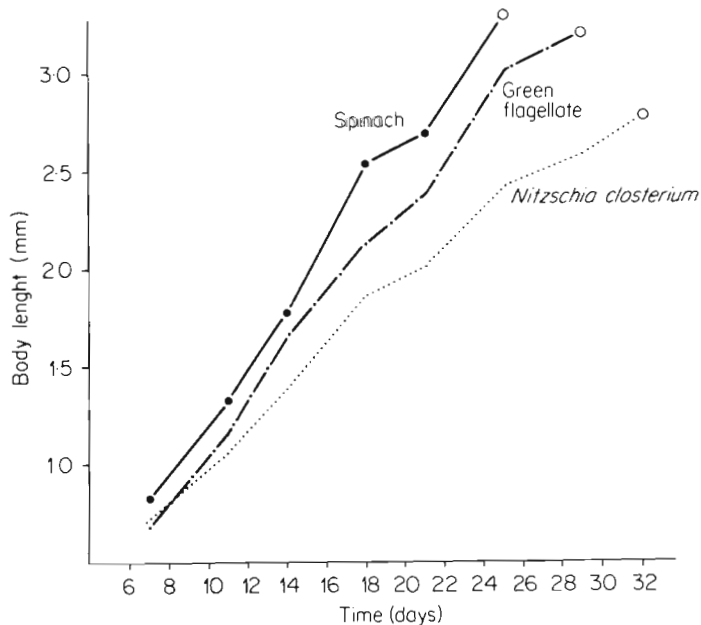

Fig. 5-25: *Ophryotrocha labronica*. Body length and first oviposition (open circles) as a function of food source (fragments scraped from block of frozen spinach, undetermined green flagellate, *Nitzschia closterium*) and time. Mean values of 40 individual data. 20° C; 32 to 34‰ S. (After ÅKESSON, 1970; modified; reproduced by permission of Biologische Anstalt Helgoland.)

genesis is increased. At 30° C, growth declines and eggs fail to develop. At 32° C, larvae and adults die within 1 week. At 14° C, reproduction is still possible, but it takes almost 5 times as long for a life cycle to be completed as at 26° C. While *Ophryotrocha labronica* develops normally in salinities between 23‰ and 40‰, the rate of egg development decreases in 44‰ S. In 48‰ S, adults die within 10 days. In 16‰ S, growth is still possible and egg masses may be produced; however, the eggs do not develop. In 17‰ S, the percentage of successful egg development varies between 0 and 50%; in 18‰ S between 60 and 70%; and in 20‰ S, about 80% of the eggs develop successfully. Normal sea-water salinities near 35‰ S appear to provide optimum conditions.

The euryhaline omnivorous *Ophryotrocha puerilis* develops well without much difficulty in glass-lid covered Petri or Boveri dishes containing sterilized, non-aerated sea water (20° to 23° C). It can be sustained by offering spinach, freshly heat-killed nauplii of *Artemia salina* or various species of unicellular algae, e.g. *Chlorella* sp. (e.g. MÜLLER, 1962; see also HUTH, 1934; HARTMANN and HUTH, 1936; BACCI, 1951a, b; ÅKESSON, 1967; PFANNENSTIEL, 1973). PFANNENSTIEL found freeze-dried spinach to be superior to the other food sources mentioned for supporting *O. puerilis*. He kept his cultures under fluorescent light (daylight type; photoperiod: 16 hrs light) and temperatures of about 20° C.

In single-individuum cultures, *Ophryotrocha puerilis* passes through a brief initial male phase. With an average of 9 parapodium-carrying segments, sperm production commences. With an average of 16 parapodium-carrying segments, isolated individuals become females; usually, they retain this sex until death. Sexual differentiation depends on environmental factors (HARTMANN and HUTH, 1936; HARTMANN and VON LEWINSKY, 1938, 1942; MÜLLER, 1962) and genetical factors (BACCI, 1951a, b, c, 1955; BACCI and BORTESI, 1960, 1961a, b; MÜLLER, 1962).

If two females, previously kept in single-individuum cultures, are joined in a pair culture, one partner transforms into a male within 1 week and fertilizes the eggs of the other. Both partners continue to change their sex at irregular intervals, but more or less simultaneously. The mutual influence of a pair depends on direct contact of the partners (PFANNENSTIEL, 1973).

Reproductive and regenerative processes in *Ophryotrocha puerilis*—as in other investigated annelids—are correlated with neurosecretion. According to PFANNENSTIEL (1973), intact, isolated *O. puerilis* females may change sex if starved. Decerebrated females produce spermatozoa earlier than fasting females. The effect of decerebration can be completely compensated by implantation of female prostomia. Decerebrated males with implanted female prostomia promptly start to produce oocytes; however, these oocytes are not shed. Most decerebrated females which were implanted male prostomia changed to the male phase.

Platynereis dumerilii

Platynereis dumerilii was successfully cultivated over several years in glass dishes containing filtered, sterilized, stagnant North Sea water of 25° C (HAUENSCHILD, 1955). The culture water was renewed at 3-week intervals and the green alga *Chlorodendron subsalsum* offered as food source. In order to control excess bacterial growth, two protozoans were added to the polychaete cultures: the dinoflagellate *Oxyrrhis marina* and an undetermined hypotrich ciliate (see also HAUENSCHILD, 1959a, 1960).

In a later study, HAUENSCHILD (1961) employed sterilized, aerated North Sea water, renewed every 2 weeks, and fed his *Platynereis dumerilii* 'Vitawil' (dry commercial pet-fish food) and *Platymonas* sp. HOFMANN (1966) continued HAUENSCHILD's cultures in aerated water employing 20 × 20 × 6-cm Plexiglas dishes of 500 ml. He sterilized the North Sea water for 45 mins at 80° C and renewed it at 2-week intervals, replacing evaporated water with distilled water. Synchronization of sexual activities was affected by 3 week's exposure to a long-day photoperiod

(16 hrs light), followed by 1 week of continuous light. FISCHER (1965) used material of HAUENSCHILD's *P. dumerilii* cultures for studies on chromatophores and colour change, and HAUENSCHILD (1974) studied the normalization of development in headless fragments due to treatment with preserved prostomia of conspecifics.

Pomatoceros triqueter

The serpulid tube-worm *Pomatoceros triqueter* is common on temperate rocky shores. It attaches its calcareous tubes to solid substrata such as rocks, stones or shells. FØYN and GJØEN (1954a) carried out artificial fertilization with worms taken from the sea and reared the larvae obtained to adulthood. After breaking the tubes and removing the worms, females and males were separated. Mature females have a deep red-violet, mature males a cream-coloured abdomen. The abdomens were cut off; the female abdomen was placed in a jar containing about 100 cm³, the male abdomen in a Boveri dish containing about 10 cm³ of sterilized sea water. The abdomens readily release their gametes. Spermatozoa were pipetted into water containing the eggs. At 18° to 20° C, the first division became visible after about 100 mins, the second after 120 mins. While free spermatozoa may be active for 24 hrs, they should be used for fertilization within 60 mins following their release and, for best results, eggs should be used immediately after their discharge.

Swimming larvae occurred after about 20 hrs and began to feed on *Chlamydomonas* sp. about 2 days following fertilization. They were kept in glass jars containing 1 l of filtered sea water (0.2 g of additional CaCl₂) and sufficient *Chlamydomonas* to give the water a light greenish colour. The water was changed once or twice a week. One or two months later, the young worms were allowed to attach themselves to slides of frosted glass. After firm attachment, the slides were suspended in an aquarium, receiving unfiltered running sea water, or submerged in the sea in a netted cage. If removed from its original tube, *Pomatoceros triqueter* may secrete a calcareous ring near the crown region, but cannot produce a new tube.

In contrast to numerous other polychaete larvae, the larvae of many serpulids—in particular of *Pomatoceros triqueter*—can easily be reared in the laboratory (SEGROVE, 1941).

Newly settled larvae of *Pomatoceros triqueter* secrete a delicate semitransparent tube. On suitable substratum free of detritus, the tube remains open towards the ground; in other cases, the tube encloses the larva completely. At 18° to 20° C, metamorphosis begins after 10 or 15 days. Larvae which fail to metamorphose may survive several months but eventually develop structural abnormalities and die (SEGROVE, 1941; FØYN and GJØEN, 1954a). Well-fed *P. triqueter* grow quite rapidly and, 4 months after settlement, may attain tube lengths of 28 to 42 mm and sexual maturity. Growth and tube secretion slow down considerably at temperatures between 7° and 2° C (THOMAS, 1940; FØYN and GJØEN, 1954a; KLÖCKNER, 1971). The total life span of *P. triqueter* from the Oslofjord amounts to about 1½ years. Maximum tube length is about 75 mm. Cross-fertilization and breeding experiments have revealed interesting details on genetic variability in the colour pattern of the branchial crown (FØYN and GJØEN, 1954b).

KLÖCKNER (1976) studied *Pomatoceros triqueter* under field and laboratory-culture conditions. He determined thermal tolerances of adults and measured

rates of growth, tube regeneration, oxygen consumption and filtration in cultured individuals.

Sabellaria vulgaris

Inhabiting intertidal areas along the Atlantic coast of the USA, this sand-tube builder has been cultivated by NOVIKOFF (1937, 1938, 1939), CURTIS (1973) and ECKELBARGER (1975). In sexually mature individuals, abdominal segments are pink in the female and white in the male. Ova or spermatozoa are shed almost immediately after a ripe worm has been removed from its tube.

For obtaining uninjured individuals, NOVIKOFF (1937) suggests the following procedure: (i) remove the sand tube from the underlying shell or rock; (ii) break away enough of the tube to make the head and tail visible; (iii) carefully force the worm from the tube by inserting a blunt probe into the head end of the tube. For gamete release, the female is placed into a finger bowl containing 200 cm³ of filtered sea water, the male into 4 drops of filtered sea water.

For insemination, NOVIKOFF (1937) recommends allowing the eggs to remain in sea water for about 15 mins. During this time, 1 drop of sperm shed into 4 drops of sea water is diluted with 4 drops of sea water, and 1 drop of this diluted suspension is added to a finger bowl containing about 260 cm³ of sea water. Drawn up in a narrow dropper, the eggs are then transferred into this suspension. While WATERMAN (1934), who described reproduction, maturation and fertilization, placed female and male together in one finger bowl, NOVIKOFF lists the following advantages of his method: (i) The egg stages obtained are more alike; (ii) the eggs are free of debris; (iii) the use of a small quantity of spermatozoa gives higher percentages of normal development, and polyspermy (which might otherwise be encouraged) is avoided. According to NOVIKOFF, the larvae of *Sabellaria vulgaris* live 'fairly well' on a diet of the diatom *Nitzschia* sp.

Employing a technique similar to that used by NOVIKOFF (1937), ECKELBARGER (1975) hatched eggs of *Sabellaria vulgaris* at 21° to 23° C. He transferred the larvae to 3.8-l glass jars containing Millipore-filtered (0.45 µm) sea water that was gently aerated. In order to reduce salinity changes, the water surface was covered with parafilm. The culture water was replaced twice a week and the larvae fed at each water change (100 ml of a 3 : 1 mixture of *Dunaliella* sp. and *Isochrysis* sp.). A small quantity of sand from *S. vulgaris* tubes (ground with pestle and mortar, rinsed several times in filtered sea water, air dried, and passed through a 73-µm Nitex sieve) was distributed on the culture-jar bottom, 12 days after the larvae were added. Following larval settlement, ECKELBARGER added additional small amounts of pretreated tube sand several times a day to provide material for tube construction.

Other Species

Memoirs on *Aphrodite aculeata*, as well as on species of *Amphitrite*, *Pomatoceros* and *Sabella*, have been published by FORDHAM (1925) and THOMAS (1940), respectively. *Chaetopterus variopedatus* and *Polydora ciliata* receive brief attention on p. 740.

Perinereis cultrifera, *Nereis irrorata*, *Platynereis dumerilii*, *Autolytus pictus* and related forms have been cultured by DURCHON (1948, 1949, 1950, 1951, 1952, 1956a, b) and HAUENSCHILD (1955, 1956a, b, 1959a, c, 1960, 1961, 1974) and their associates, primarily for endocrinological investigations. The cultivation of these species is easy. It has been performed under conditions comparable to those described for *Ophryotrocha puerilis* (p. 731). Additional culture experiments on nereids have been conducted on *Nereis caudata* (REISH, 1953, 1957c), *N. grubei* (REISH, 1954) and *N. vexillosa* (JOHNSON, 1943).

The larval development through settlement of sabellarid polychaetes has been studied under laboratory conditions by several investigators (literature *in*: ECKELBARGER, 1975). *Sabellaria alveolata* has been cultivated by WILSON (1929) and CAZAUX (1964), *S. spinulosa* by WILSON (1929), *Phragmatopoma californica* by DALES (1952), and *P. lapidosa* by ECKELBARGER (1975).

Starved and fed (flagellates; diatoms; unnatural foods such as kaolin with adsorbed olive oil, casein or soluble starch) *Terebella lapidaria* have been short-term cultured by SUTTON (1957) in order to investigate the feeding mechanism. *T. lapidaria* is an omnivorous particle feeder. Collected by the tentacles, the food is transferred to the upper lip and conveyed by cilia to the mouth. Food movement along the alimentary canal is facilitated by peristalsis and cilia. *Proceraea cornuta* and *Autolytus brachycephalus* have been cultivated by HAMOND (1974).

Several marine Archiannelida, notably of the genera *Dinophilus* and *Protodrilus* have been sustained in laboratory cultures. The archiannelids are a small polychaete group of diverse origin and with reduced structural characteristics; they have no parapodia, little or no segmentation and a ciliated epidermis. Their development, reproduction, sex differentiation, sex determination and morphology have been subject to numerous experimental inquiries (e.g. KORSCHOLT, 1882; CONKLIN, 1906; VON MALSEN, 1906; BEAUCHAMP, 1910, 1912; SHEARER, 1912; NACHTSHEIM, 1914; SHEN, 1936; TZONIS, 1938; TRAUT, 1966a, b, 1968). Based on earlier culture methods, TRAUT (1968) has cultivated *Dinophilus gyrotilatus* at 20° C in glass dishes containing 1 to 1.5 ml pasteurized sea water (about 32‰ S). The worms were isolated individually and transferred every 5 days into new containers (12-hr day). To avoid impurities, for each single transfer a sterilized pipette was used. TRAUT offered the unicellular alga *Pseudostichococcus* (?) *monallantoides* as food. Under the conditions described, hatching occurs after 6 days. Upon hatching the short-lived dwarf males of *D. gyrotilatus* are already sexually mature and copulate immediately with freshly hatched or older females. After copulation, the females store the sperm received until oviposition, which begins about 6 days after hatching. Generation time is about 12 days.

In samples of coarse sand, kept at 16° C, adult *Protodrilus rubropharyngeus* aggregated at the sand surface within 30 mins. Larvae were obtained by towing a fine-mesh plankton net (100- μ m pore size) near the beach at Klubban (Sweden). They were collected under a binocular microscope. GRAY (1967) transferred adult individuals and larvae to glass tubes or Petri dishes containing sand and sea water, and studied patterns of substratum selection. Both adults and larvae prefer sand-grain sizes between 0.5- and 1-mm diameter and are attracted by a favourable number of bacteria of the right type, forming a film on the sand-grain surfaces. The presence of adult *P. rubropharyngeus* attracts further specimens. All these factors

tend to restrict the distribution to narrow beach areas (GRAY, 1967; see also JÄGERSTEN, 1940).

Similar substratum-selection patterns were previously found in cultured *Protodrilus symbioticus* (GRAY, 1966a, b). Responses of *P. symbioticus* to temperature and light have been reported by GRAY (1965, 1966c).

(b) Oligochaeta

Enchytraeus Species

Inhabiting coastal and terrestrial habitats, the white worm *Enchytraeus albidus* has been used as an experimental animal for studying responses to salinity (KRIŽEN-EČKY, 1916; SCHULZ, 1916); non-genetic adaptation to temperature and salinity (KÄHLER, 1970); effects of nutrition and substrate salinity on behaviour; reproduction and water balance (SCHÖNE, 1971); and aspects of ion regulation (SIEBERS, personal communication). Mass cultures of *E. albidus* receive attention on p. 737.

SCHÖNE (1971) kept her *Enchytraeus albidus* (photoperiod 12:12; 20–22°C) on sea-water moistened sand and offered *Fucus* sp., green algae, *Zostera marina* and *Delesseria* sp. as food. Rates of food consumption and reproduction and length of life span suggest that the nutritional value of the plants offered parallels the above sequence. On a *Fucus* diet, 60 to 70% of the worms survived for more than 4 weeks on sand, but only for about 1 week on moist filter paper. Reproduction is possible in salinities up to 40‰. Cocoon production is most frequent in 5‰S. Incubation is shorter in 0 to 15‰S than in 30 and 40‰S. Young worms in the cocoons survive best at 15‰S.

Enchytraeus fragmentosus, which multiplies by fragmentation, has been cultivated axenically (DOUGHERTY and SOLBERG, 1961; see also Chapter 5.11). The crudely oligidic culture medium was based upon liver extract. DOUGHERTY and co-authors (1963) obtained information about conditions which induce tumour-like growth and lysis.

Tubifex hattai

Eggs of *Tubifex* species have been removed from the cocoon and incubated in a medium consisting of : NaCl, $\frac{1}{50}$ M, 2 parts; KCl, $\frac{1}{50}$ M, 2 parts; CaCl₂, $\frac{1}{50}$ M, 65 parts; MgSO₄, $\frac{1}{50}$ M, 25 parts (LEHMANN, 1948). For denuded eggs of the Japanese *T. hattai*, however, LEHMANN's medium was too concentrated; only about 50% of the *T. hattai* eggs hatched (INASE, 1960a). Near 18°C, hatching rate increased to 74% when LEHMANN's solution was diluted to two-thirds of its original concentration (INASE, 1960b). However, monstrosities—mainly double embryos—developed about as frequently as normal embryos, while in the controls (eggs remaining within the cocoon capsule, kept in previously boiled tap water) hatching rate was 71% with 'a low rate' of monstrosities (INASE, 1960b, p. 66). In this second study, INASE also varied the ratios of NaCl, KCl, CaCl₂ and MgSO₄, with the total medium osmoconcentration remaining at two thirds of LEHMANN's recipe. The best results (78% survival to hatching, 54% normal embryos) was obtained at the following salt concentrations (g l⁻¹ medium): NaCl, 0.28; KCl, 0.09; CaCl₂, 0.89; MgSO₄, 0.24.

(c) Annelida as Assay and Food Organisms

Most of the annelids successfully cultivated over many years for physiological or endocrinological purposes provide assay material. *Capitella capitata* cultures have been employed by BELLAN and co-authors (1972) for assessing sublethal effects of a polyethylene-glycol fatty-acid detergent on reproduction, development and settlement. Even very low concentrations (0.01 mg l^{-1}) exerted some effect on at least some life-cycle stage. Survival decreased markedly in concentrations higher than 10 mg l^{-1} . The average production per female turned out to be a useful, sensitive criterion. Other investigators who have used *C. capitata* as assay organism for examining the influence of water pollution include REISH (1955, 1957a, b, 1960, 1967, 1970), REISH and BARNARD (1960), KITAMORI (1961) and BELLAN and co-authors (1971, 1972). Comparable papers have been presented by BELLAN and co-authors (1969) on *Scolelepis fuliginosa* and GEORGE (1971) on *Cirratulus cirratus* and *Cirriformia tentaculata*.

Capitella capitata, *Dorvillea articulata*, *Neanthes arenaceodentata* and *Nereis grubei* have been used for assessing the degree of pollution in marine waters (REISH, 1967, 1970). One polychaete was placed in a 500-ml Erlenmeyer flask (or in a Petri dish) containing a small amount of food (dried and resoaked *Enteromorpha* sp.) and 100 ml of sea water. Survival rates over 28 days (median tolerance limits) were determined in critical levels of phosphates, nitrates and silicates and decreased oxygen concentrations. Using adult *Pomatoceros triqueter*, KLÖCKNER (1976) examined resistance to red-mud pollution.

Ophryotrocha labronica (p. 729) has been proposed as assay organism for assessing biological consequences of water pollution by ÅKESSON (1970). This small worm meets a number of important prerequisites: (i) it can be conveniently bred under laboratory conditions for years; (ii) test material for experiments may be obtained in all seasons; (iii) small body size (rarely exceeding 4.5 mm) facilitates space-saving cultivation and experimentation; (iv) it tolerates crowding; (v) in view of its considerable reproductive potential (about 120 eggs per female; oviposition every other week for at least 3 months), experiments can be conducted on larvae from a single egg mass; larval populations large enough for statistical analysis can be obtained by synchronizing the oviposition of a number of females; (vi) experiments may be extended over the entire life cycle (at 20°C , the life cycle is completed in less than 4 weeks); (vii) transportation over several days is possible in a closed thermos container. Useful criteria for assessing water-pollution effects are: survival of different life-cycle stages, duration of life-cycle stages, body growth and reproductive rate.

Using *Ophryotrocha diadema*, *O. labronica* and the archiannelid *Dinophilus gyrociliatus*, ÅKESSON (personal communication) tested the biological effects of oil dispersants, phenol and waste water from a sulphate pulp mill. All three annelids are small and easily cultivated. Their life-cycle stages are available throughout the year. Since *O. labronica* is gonochoric with a female: male ratio of approximately 2:1, and since the sexes do not always respond in exactly the same way to the test substances, the hermaphroditic *O. diadema* constitutes an even better assay organism. The generation time of *O. diadema* is about 4 weeks at 20° to 21°C . In 6-week experiments, ÅKESSON examined the responses of all life-cycle stages and used

growth, mortality, time to maturity (reproduction), and productivity (number of egg masses, mean number of eggs or egg masses, and egg mortality) as criteria for assessing the degree of water pollution. Culture method: 20° to 21° C, filtered, pretreated sea water of 33 to 34‰S; food: fragmented spinach soaked in sea water; semi-spherical bowls with 80 ml sea water for adults, 15-ml bowls for larvae (see also p. 734).

Larvae of the polychaete *Sabellaria spinulosa* have been used as assay organisms by WILSON (1968a) for detecting the presence of 'detergent' BP1002 at concentrations of 1 ppm. The larvae were reared after artificial fertilization receiving *Isochrystis galbana* as food source; they appeared to be irritated (flexing their bodies ventrally and erecting their provisional bristles). Assay tests were carried out in 50-ml Monax dishes lightly covered with watch glasses and containing unfiltered sea water of 15° C. *S. spinulosa* larvae obtained by tow netting and raised in the laboratory through the final stages of development were used (WILSON, 1968b) to assess the toxicity of sand soaked for 90 mins in sea water containing 'detergent' BP1002 in concentrations of 1000 and 100 ppm. Larvae crawling on the sand revealed damage soon afterwards.

The lugworms *Arenicola cristata* and *A. marina* (p. 720) are cultivated as bait for a number of fishes (e.g. in USA) and as food for aquarium fishes and cultured sturgeons (USSR, USA). Newly hatched worms receive a mixture of organic detritus and sediment as food. They grow rapidly and are tolerant to crowding and low levels of dissolved oxygen. Mass cultures of lugworms still pose several biological and technical problems. D'ASARO (1973) has presented descriptions of hatchery procedure and of the basic components of a lugworm hatchery. Lugworms are a suitable food source for many fish species and for invertebrates such as crustaceans.

Several oligochaetes have been used as food for marine animals, notably species of the white worm *Enchytraeus*, the earthworm *Lumbricus* and the small red worm *Tubifex*.

The white worm *Enchytraeus albidus* is acceptable as food to many marine invertebrates and fishes. Constant daily care, several small cultures rather than large ones, moist substratum and frequent small-portion feeding provide the key to successful white-worm cultivation (BLOUNT, 1937; LOOSANOFF, 1937b). A dishpan or wooden box, filled with a 5-8 cm layer of a light, dark garden soil (which does not easily harden when dry and is not sandy), and covered by a wooden lid (allow for access of air!) serves as culture container. Moist food (cereals such as oatmeal, pulverized milk crackers, bread soaked in water or milk, crushed bone powder, pieces of boiled potatoes with the skins attached) is spread over about 30% of the substratum surface (where the worms are found) and covered by a glass plate. For best results the diet should be varied. Cocoons are deposited on the food, and young worms accumulate near food and glass plate. If the food portions are too large, excessive mould may develop. Cultures in good condition often attract *Drosophila* flies. Souring of cultures and strong illumination must be avoided. Temperatures should be between 15° and 20° C. Optimum humidity must be maintained by frequent addition of small amounts of fresh water (sprinkling, not pouring). Excessive water should be drained.

To start a new culture, at least some 100 worms should be placed together in the middle of the substrate surface. Harvesting must be discontinued until the new

population has become fully established. Large worms are harvested by transferring (using forceps) masses of them into a dish with water for cleaning. Small worms can be harvested by washing the under side of the glass plate.

The common earthworm *Lumbricus terrestris* is a preferred food item for larger, cultured marine invertebrates. Collection is accomplished at night, preferably between 10 and 12 p.m., during or following a warm drizzle, when the worms come to the surface. Injured specimens are removed and healthy individuals transferred to large boxes (HESS, 1937). The boxes are filled about 30 cm deep with approximately equal parts of old leaves and leaf loam gathered in the woods. Heavy clay soil must be avoided. Feeding on the dead leaves, the earthworms do not need other food. The substratum should be kept moist (but not saturated with water).

Earthworms also develop well in very light loamy soil (HESS, 1937). In this case, the worms must be fed (pre-cooked cereal, bread crumbs, cornmeal). New food, moistened with water, should be spread sparingly over the top of the soil every two or three weeks and covered with about 2.5 cm of loam. Too much food will deteriorate and the culture may die. The culture boxes should not be overpopulated. Temperatures should be kept below 16° C. Cocoons are not easily obtainable, but a few may be found when carefully sorting the loamy material after about 1 month. Young worms emerge from the cocoons in a few weeks and thrive under the conditions provided for the adults.

Hardier than *Lumbricus terrestris*, the faecal earthworm *Eisenia foetida* keeps well in moist, rotten cow and horse manure. It forms large numbers of cocoons in the laboratory if kept in conditions supplied with such material (HESS, 1937). According to a note by NEEDHAM (1937), R. W. MOLTKE provided the following instructions: (i) Select a shady place in well-drained soil for a culture bed of about 1 × 2 m; (ii) dig out 30 to 40 cm of soil and fill with well-rotted manure; (iii) wet down thoroughly and add the worms by distributing them over the surface; (iv) cover the worms with a sprinkling of rotten manure and allow them time to burrow; (v) add some pieces of old, soaked bread and cover these with manure; (vi) feed the worms once a week by spreading over the surface moistened cornmeal, old bread or vegetable refuse from the kitchen, covering this with rotten manure each time and adding a layer of straw or sacking to retain the moisture; (vii) sprinkle the bed with water whenever it shows signs of getting dry; (viii) harvest worms by turning over the surface layer of the culture substratum with a hand digging fork (dig in a new place every time).

Details on commercial fish worm production (red worm; species?) have been presented by SWINGLE (1961). Used as fish bait and food for cultured animals, red worms have been mass cultured in outdoor beds made of 5 cm × 25 cm pine or cypress boards nailed together in a rectangle or in concrete or brick beds. The beds should be located in a shaded area protected from excessive rain, and, in order to provide good drainage, arranged on top of the ground. In commercial worm beds, no soil is used. Decaying feed provides a peat-like substratum in which the worms thrive. According to SWINGLE, this is superior to soil because worms are easier to harvest and come out clean. The protein content of the worm feed is important; it should neither be less than 9% nor more than 15%. Insufficient protein reduces growth rates and the beds become so acid that hatching is inhibited. Too much protein results in too rapid decay and 'makes the beds hot'. Such beds attract

flies. A feed with 10 to 12% protein is considered optimal. Sufficient fibre in the feed is necessary to keep the substratum loose and porous. The worms are ready for harvesting about 6 months after hatching. The substratum is turned by hand or with a spading fork, and sufficiently large worms are picked out. Between 7800 and 16,700 worms may be harvested per square metre during a 6- to 8-month period.

Several species of *Tubifex* are used as food for a variety of invertebrates and fishes. While mass cultivation of these oligochaetes seems to be relatively easy, very little detailed information is available. The Japanese species *T. hattai* has been cultured by INASE (1960a, b) in an artificial medium (p. 735). Freshwater-living Tubificidae often inhabit a variety of muddy habitats in high abundance, especially where large amounts of organic matter accumulate and undergo decay. Tail ends waving in the water, they keep their heads buried in the mud. For collection, LA RUE (1937) suggests: (i) determine how deeply the worms are embedded in the mud; (ii) scrape or scoop up the mud layer containing the worms with a small shovel and place it in pails; (iii) in the laboratory, transfer the contents of a pail into a shallow pan receiving a continuous small stream of tap water through a rubber hose. The worms come to the surface in a few hours. At night, they tend to migrate out of the pan unless it is firmly covered. Mass cultures may be fed with mud, decaying vegetable matter, or with manure or potato.

(d) Annelida: Conclusions

Much of our knowledge on cultivation of marine annelids has been produced in context with experiments conducted to investigate physiological, biochemical or endocrinological problems. However, a few papers deal also with aspects of experimental ecology: rates of metabolism and growth, energy budgets and reproductive biology, as well as with metamorphosis, sexual differentiation and regeneration.

Practically all culture experiments have been performed in small enclosures such as Petri dishes, Boveri dishes or small aquaria—often in stagnant and sometimes even in non-aerated sea water. Most of the annelids cultivated thus far are rather hardy animals. Stenoplastic forms are likely to require more sophisticated methods of culture-water management.

Among the diets offered to cultured annelids were spinach, a variety of unicellular algae (diatoms and flagellates), commercial fish foods such as 'Vitawil' or 'Piscidine' and animals (e.g. *Enchytraeus albidus*). Convenience and availability of food organisms seem to have determined this list, rather than attempts to match the dietary variety consumed by the annelids under natural conditions.

Nutritionally, annelids are characterized by an impressive diversity. Food organisms and feeding types vary considerably in different groups and sometimes even in closely related species. Some annelids are predators consuming a variety of small invertebrates including other annelids and crustaceans; others feed on seaweeds using their jaws to tear off small pieces. Most burrowing forms lick off or swallow sediment particles. They make use of the bacteria, protozoans, fungi, diatoms, etc. as well as of the dead organic materials accumulated among or on the sediment particles. Many sedentary polychaetes are ciliary feeders, consuming fine particulate organic matter, either suspended in the surrounding water or sedimented on the

nearby bottom. Mucus on the palp's surface traps small detritus particles and helps to carry them to the mouth. Some Spionidae have long contractile tentacles; they catch their food either from the ambient water (e.g. *Polydora ciliata*) or collect it from the substratum surface (e.g. *Pygospio elegans*). *Polydora ciliata* feeds on detritus and small phyto- and zooplankters. Particles that come into contact with the fast moving tentacles are caught and transported in ciliary bands to the prostomium (Fig. 5-26). Here the food is selected (HEMPEL, 1957). The slow moving tentacles of *Pygospio elegans* collect small weakly motile organisms and detritus.

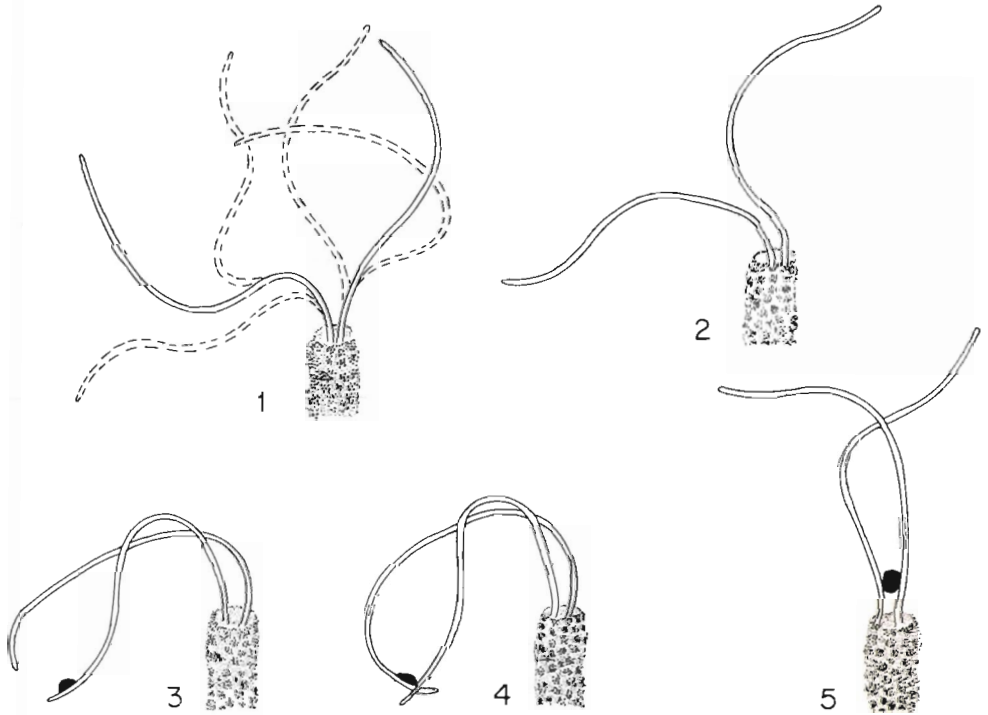

Fig. 5-26: *Polydora ciliata*. Successive stages of food collection. As soon as a drifting food particle is caught by one of the rapidly pendulating tentacles of this tube-building polychaete, the second tentacle cooperates in moving the food swiftly towards the mouth. For swallowing larger prey, the pharynx must be everted. (After HEMPEL, 1957; modified; reproduced by permission of Biologische Anstalt Helgoland.)

HEMPEL's cultured *P. elegans* accepted also small pieces of *Enchytraeus albidus* and the commercial fish food 'Piscidine'; single sand grains are collected and their bacteria-diatom film licked off. In the filter net at the tip of the tube, plankton organisms get caught and are, from time to time, consumed.

More specialized and, apparently, more effective filter nets which retain plankton and detritus carried by ambient or self-produced water currents have been reported from several polychaetes. *Chaetopterus variopedatus*, for example, fans water through its U-shaped tube (Fig. 5-27a, b). Moved by modified body structures, the water is filtered through a plankton-net-like mucus bag stretched out between a pair of aliform notopodia (an) which form a ring-shaped opening and the dorsal cupule (dc).

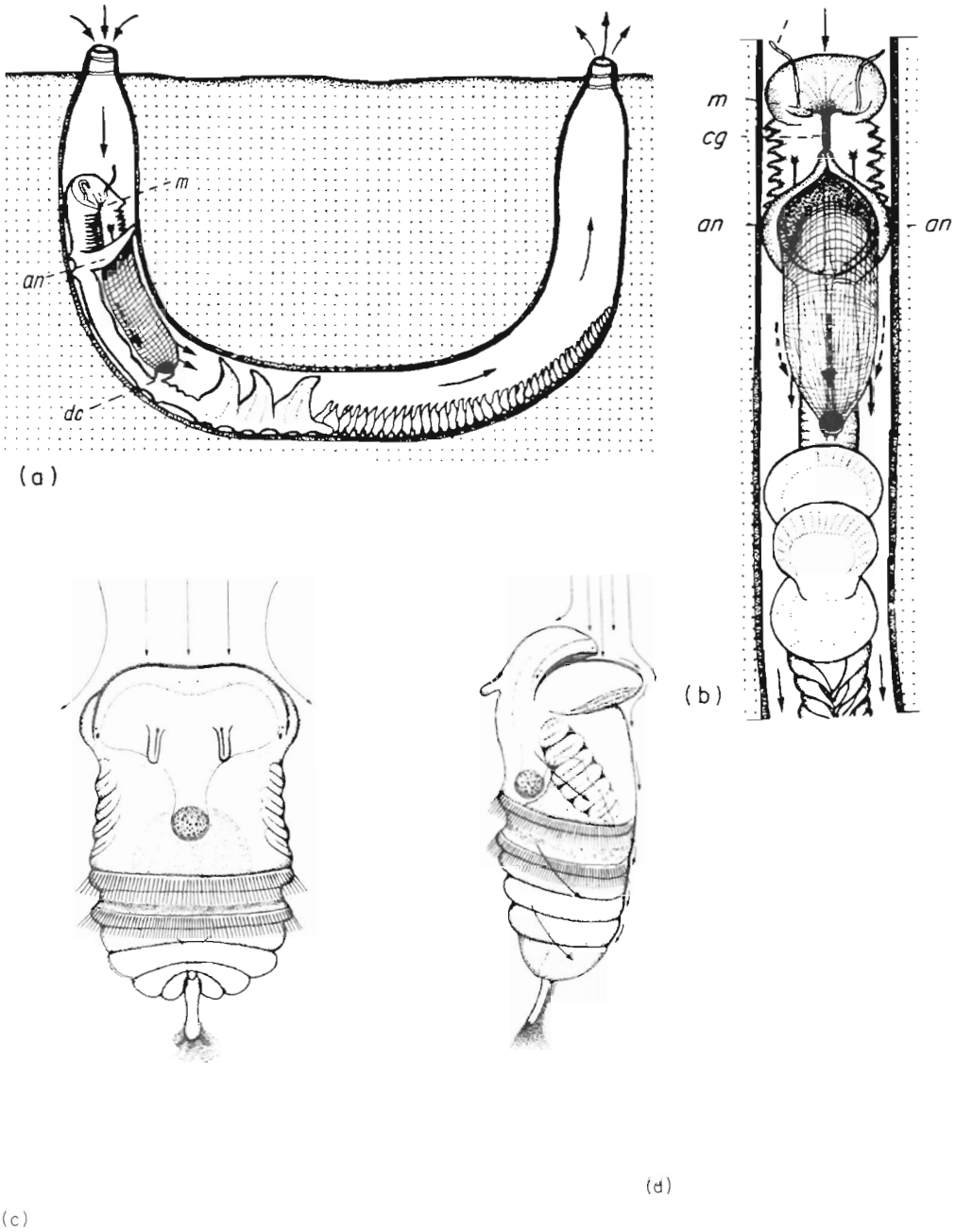

Fig. 5-27: *Chaetopterus variopedatus*. Filter feeding by continuous mucus filter in adult (a, b; for explanation see text) and by mucus net in larvae (c, d). (a and b after WERNER, 1959; reproduced by permission of VEB Deutscher Verlag der Wissenschaften; c and d after WERNER, 1953a; reproduced by permission of Biologische Anstalt Helgoland.)

New mucus is continuously secreted from the notopods and rolled up into a ball by the dorsal cupule, thereby closing the end of the mucus bag. This continuously produced ('endless') mucus filter was first described by MACGINITIE (1939). ENDERS (1909), FAULKNER (1931), WELLS and DALES (1951) and WERNER (1953a, 1959) confirmed this interesting discovery and added further details. If larger objects enter the tube they are shunted aside by the peristomial cilia and the aliform notopodia are raised to let them pass. However, most of the water current is directed through the mucus bag which strains out plankton and detritus. When the food-laden ball, rolled up by the dorsal cupule, reaches a certain size, it is separated, deposited onto the ciliated dorsal groove (cg), carried to the mouth (m) and swallowed. Already the larvae of *C. variopedatus* produce a slime ball or bag in the mouth funnel and a terminal slime net (Fig. 5-27c, d). While most food is collected by the inner, broad cilia band of the pre-oral lobe (THORSON, 1946; WERNER, 1953a), WERNER could demonstrate that the slime ball and slime net assist the larva in securing food. Both are swallowed at intervals. In the slime net, even active moving plankters such as veligers of *Crepidula fornicata* (ca 0.3 mm) get caught. Endless mucus filters are also employed for securing food by other marine invertebrates, e.g. the mollusc *Crepidula fornicata* (p. 892) and the tunicate *Clavelinicea lepadiformis*. The lugworm *Arenicola marina* seems to use part of the sand in its burrow as a filter for retaining food particles (p. 720).

For experimental ecologists working with annelids, knowledge of such nutritional specializations is important. Additional information on food and nutrition of polychaetes can be found in WATSON (1891, 1907), RAUSCHENPLAT (1901), HUNT (1925), NICOL (1930), WILCKE (1952), ZIEGELMEIER (1952), DALES (1955) and BARNES, H. (1963, p. 182-187). For more recent accounts consult also Volume II: PANDIAN (1975).

Several annelids have been used successfully as assay organisms, notably *Dinophilus gyrociliatus*, *Ophryotrocha diadema* and *O. labronica*, as well as larvae of *Sabellaria spinulosa*, but also *Capitella capitata*, *Dorvillea articulata*, *Neanthes arenaceodentata* and *Nereis grubei*. Many other forms that would lend themselves as assay organisms await discovery.

Arenicola marina, *Enchytraeus albidus* and *Tubifex* species, as well as the land-living *Lumbricus terrestris* and *Eisenia foetida*, are famous food organisms. All can be mass cultured easily and are used extensively as food for cultured carnivorous invertebrates and fishes.

(10) Crustacea

Of the 27,000 crustacean species known, most are marine, few live in fresh water and very few are semi-terrestrial. Although crustaceans of all major groups have been kept, at least for short periods, under laboratory conditions, appreciable success has been obtained only in a few species; most of these belong to the following groups: Branchiopoda, Copepoda, Cirripedia and Malacostraca.

The main problems in crustacean cultivation pertain to (i) providing adequate conditions for early ontogenetic stages which usually require narrowly defined environmental and nutritional conditions; (ii) the sustenance of planktonic, especially oceanic, species and of forms with numerous larval stages; (iii) the

provision of sufficient amounts of suitable food; (iv) moulting: most cultivated crustaceans die shortly before, during, or shortly after the moult.

While early crustaceans developed in a gradual succession of moultings without major changes in functions and structures—a development still exhibited by the Cephalocarida and Branchiopoda—most modern marine crustaceans are characterized by pronounced patterns of metamorphosis. Frequently, successive life-cycle stages differ from each other morphologically, ethologically and ecologically. The number of larval stages, as well as the time plan for attaining a given stage, often vary as a function of environmental circumstances. Consequently, the culturist must analyze the environmental and nutritive requirements of different life-cycle stages and achieve sufficient chronological parallelism between developmental progress and concomitant change in culture conditions and nutrition.

Crustaceans have been caught from ships using a variety of collecting gear; by hand net, preferably at night with the aid of a strong light source; baited traps; barbless hook and line, using a variety of bait. They can be transported in plastic bags filled half and half with water and oxygen or in baskets between layers of moist plants or other suitable material.

Few crustaceans have been cultivated from egg-to-egg, but copulation has been recorded in numerous species cultured. Usually preceded by a precopula, which assures the presence of the male immediately after the female's copulatory moult, copulation behaviour seems to be controlled to a large extent by chemical cues such as pheromones (e.g. SCHÖNE, 1961, 1974, 1975; CREUTZBERG, 1975) and by endogenous changes related to the moulting cycle. Commercial cultivation of crustaceans receives attention in Chapter 5.2.

(a) Branchiopoda

With the exceptions of the brine shrimp *Artemia salina* and a few cladocerans, most Branchiopoda—such as fairy shrimps and daphnids—inhabit fresh waters. A variety of branchiopods—e.g. species of *Chirocephalus*, *Branchinecta*, *Branchipus*, *Streptocephalus* and *Daphnia*—can be cultivated easily. They provide good material for experimentation, bioassays and food organisms. Only *A. salina*, a cosmopolitan inhabitant of salt lakes, receives detailed attention below.

Artemia salina

Due to the availability of dry cysts, the hardy, anostracan branchiopod *Artemia salina* has become a most familiar animal with experimental ecologists and mariculturists. Thriving in salt lakes and marshes (brine waters), *A. salina* is easy to breed and of general importance as a food organism for other cultured animals (p. 747). Axenic cultivation of *A. salina* is dealt with in Chapter 5.11 (p. 1144).

After copulation, the fertilized eggs of *Artemia salina* are retained in the ovisac. Here they develop either into free-swimming nauplii (ovoviviparity), or the development becomes arrested after the gastrula stage is attained. In the latter case, a chitinous egg shell is formed and the embryo undergoes diapause (oviparity). Shelled eggs are known as resting eggs or cysts.

Considering the factors influencing the type of reproduction (ovoviviparity versus oviparity), SORGELOOS and co-authors (in press) come to the conclusion that neither illuminance nor photoperiod exert any influence. However, in *Artemia salina* from Great Salt Lake (Utah, USA), at ambient oxygen concentrations above 4 ppm, ovoviviparity prevailed, while at 2 ppm, resting eggs were produced. As salinities increase, apparently, the concomitant reduction in dissolved oxygen triggers the changeover from ovoviviparity to oviparity.

Most *Artemia salina* cultures are started from commercially available resting eggs. Billions of cysts accumulate on the lee side of natural and man-made salterns, and pile up in windrows mixed with debris (e.g. BOND, 1937a; NIMURA, 1967). Unable to hatch until dried, the resting eggs are collected with shovel and buckets, and sold.

Egg incubation and hatching

Dried cysts remain viable for several years, especially if stored at low temperatures (-5° to 20° C) or, even better, under vacuum (PERSOONE, personal communication). Following low-temperature storage, the cysts should be exposed to room temperature for 10 to 15 days prior to incubation; otherwise, poor nauplius yields will prevail. After transfer to sea water of 20° to 30° C, the nauplii hatch in 1 or 2 days.

Resting eggs of *Artemia salina* have been mass-incubated in natural and artificial sea waters. If available in sufficient quantity, natural sea water represents the most convenient culture medium. In the absence of natural sea water, artificial media have been used which, in some cases, consisted only of very few essential components. However, in NaCl-tap-water solutions (LOOMIS and LENHOFF, 1956), hatching rates are unsatisfactory unless 'Versenate' (disodium diethylenediamine tetraacetate) and a buffer are added (FULTON, 1960). For preparing a stock hatching solution, FULTON added to 3200 ml hot tap water: NaCl, 345.6 g; Versenate, 4.8 g; NaHCO_3 , 9.6 g. The modified LOOMIS-LENHOFF procedure would, therefore, be as follows: (i) After cooling, dilute the stock hatching solution with tap water to obtain the actual hatching solution. (ii) Pour 500 ml of this solution into each of 5 hatching dishes. (iii) Seed the hatching dishes with $\frac{1}{2}$ teaspoon (3-4 ml) of eggs, just as they are stacked, as moving a dish after seeding washes many eggs onto the walls of the container, where they fail to hatch. (iv) Incubate the dishes 48 hrs at ca 21° C. The eggs will hatch in 1, 2 or 3 days at 30° , 21° or 15° C, respectively.

LENHOFF and BROWN (1970) obtained good yields of viable *Artemia salina* nauplii in a modification of the solution described by FULTON (1960). To prepare the concentrated stock solution, dissolve in 8 l of distilled water: NaCl, 864 g; NaHCO_3 , 24 g; Versenate, 12 g. The NaHCO_3 and Na_2EDTA and about 200 g of NaCl are dissolved in 4 l of distilled water, and then 4 l of hot water containing the remainder of the NaCl are added. SORGELOOS (1973a) incubated *Artemia salina* eggs in artificial sea water prepared according to DIETRICH and KALLE (1963; Volume I, p. 687).

Hatching time and hatching percentage (efficiency) vary in different strains. In cysts from San Francisco Bay (USA), maximum hatching efficiency exceeds 80 to 90%, due to the sorting technique applied at 'San Francisco Bay Brand'. In cysts from other sources, hatching efficiency is usually lower. For maximum hatching

efficiency, proper conditions of light, temperature, salinity and oxygen availability are of importance.

Light has been shown by SORGELOOS (1973c) to trigger the restart of embryonic development. Hatching efficiency of resting eggs from Bulgaria and USA (Utah, California) was 26, 48 or 62% in darkness, versus 40, 73 or 95% in daylight. Later experiments revealed that it is sufficient to illuminate the resting eggs briefly after hydration, in order to ensure efficient hatching (SORGELOOS and PERSOONE, 1975). The minimum exposure time depends on the irradiance employed (the critical wavelength has not yet been determined). For California eggs, illumination for 10 mins at 2000 lux is sufficient. The total number of offspring produced is higher in darkness than in light (SORGELOOS and co-authors, in press).

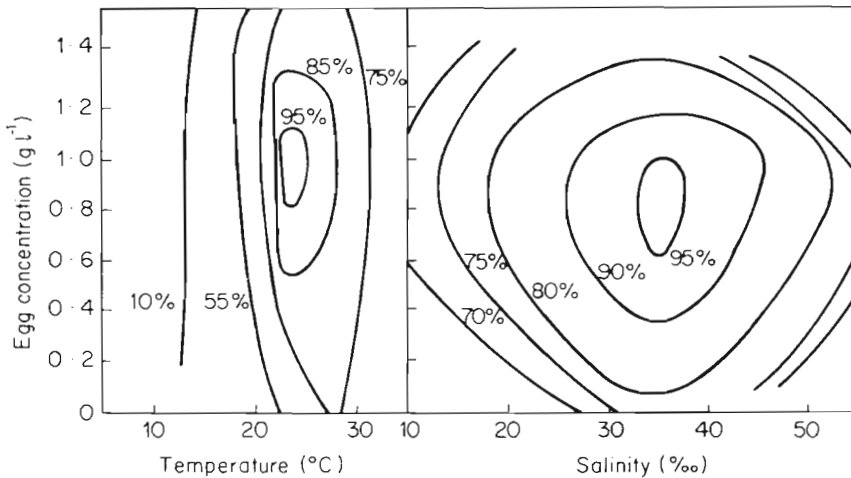

Fig. 5-28: *Artemia salina*. Percent hatching of resting eggs from San Francisco (USA) during a fixed 36-hr incubation period. (After NASH, 1973; modified; reproduced by permission of Elsevier Scientific Publishing Company, Amsterdam.)

Temperatures for maximum hatching efficiency range from 20° to 35° C. BOONE and BAAS BECKING (1931) report highest efficiencies between 28° and 30° C; LENHOFF and BROWN (1970), between 22° and 24° C; VON HENTIG (1971), between 20° and 30° C; JONES (1972), between 23° and 26° C; NASH (1973), near 24° C (Fig. 5-28); and SORGELOOS and PERSOONE (1975), at 28° C in eggs from California (USA), at 30° C in eggs from Utah (USA), and at 35° C in eggs from China.

Salinity levels supporting good hatching rates range from 5 to 90‰ (SORGELOOS and PERSOONE, 1975). JENNINGS and WHITAKER (1941) recorded high hatching rates between 10‰ and 50‰ S. VON HENTIG (1971) found the combination of 20° C and 32‰ S to be optimal for maximum hatching success. NASH (1973) obtained maximum hatching in 35‰ S (Fig. 5-28). Additional papers on salinity effects on hatching have been presented by JACOBI and BAAS BECKING (1933), BAAS BECKING and co-authors (1936) and CLEGG (1964).

The effects of dissolved gases remain to be investigated in detail, particularly responses to carbon dioxide. GILCHRIST (1954) recorded minimum oxygen concentrations for hatching of about 3 ppm. According to NIMURA (1968) and SORGELOOS

(personal communication), hatching rates of resting eggs from California remain constant between 2 and 8 ppm; below 2 ppm, hatching efficiency decreases and at 0.8 to 0.6 ppm, hatching is completely inhibited (SORGeloos and PERSOONE, 1975). Continuous, mild aeration, adjusted so as to maintain the eggs in suspension, is recommended during incubation. Heavy aeration may injure hatched nauplii. To prevent foaming, SORGeloos and PERSOONE add a few drops of a non-toxic silicone antifoamer to the culture water.

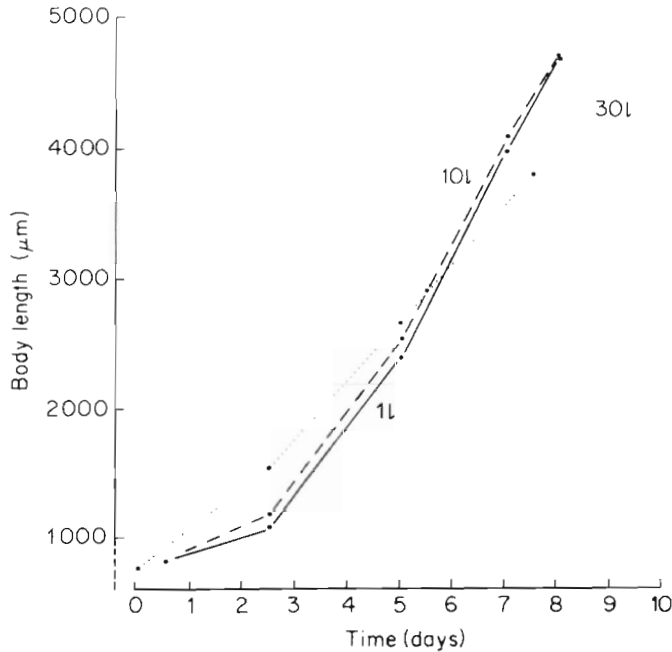

Fig. 5-29: *Artemia salina*. Increase in body length of larvae cultivated in the 1-l, 10-l, or 30-l containers illustrated in Fig. 5-33. Darkness; 28° C; artificial sea water according to DIETRICH and KALLE (1963; Volume I, p. 687). (After SORGeloos, 1973a; modified; reproduced by permission of Elsevier Scientific Publishing Company, Amsterdam.)

Rearing of larvae, subadults and adults

All life-cycle stages of *Artemia salina* thrive on unicellular algae such as *Dunaliella salina*, *D. viridis* or *Platymonas subcordaeformis*, as well as on bacteria and yeast (e.g. SHIMAYA and co-authors, 1967). Unicellular algae may also be offered in the form of a dry powder. 'Mikrozell Dohse Aquaristik' (Bonn, FRG), for example, sells unicells such as *Scenedesmus* sp. in powder form. JONES and co-authors (1974) have shown that *A. salina* can also be sustained on micro-encapsulated diets. They used microcapsules (20- to 80- μ m diameter) with cross-linked nylon-protein walls. 4,4'-Diamino-2,2'-biphenyldisulphonic acid (6 mM l⁻¹) was added to give the membrane a negative charge which reduces capsule aggregation. The capsule walls

are easily ruptured by the mouth parts of *A. salina*. A wide range of water-soluble material and of particulate matter can be encapsulated to give capsules which are almost neutrally bouyant. The walls of the capsules used are permeable to small molecules; hence, they can best be used for macromolecular food items. Growth coefficients of *A. salina* reared on different dry foods increased with the amount of crude protein in the diet. However, at crude protein levels exceeding 28%, growth decreased due to increasing ammonia concentrations in the culture water (HANAOKA, 1973).

Using the culture enclosures illustrated in Fig. 5-33, SORGELOOS (1973a) obtained the growth rates shown in Fig. 5-29. Even at high population densities, these growth rates compare favourably with those reported under low-density conditions (e.g. TERAMOTO and KINOSHITA, 1961; WALNE, 1967; VON HENTIG, 1971; SORGELOOS, 1973b). Good growth rates were obtained in darkness and under conditions of intermittent aeration (1 min aeration for each half hour), feeding larvae or subadults twice daily (ca 50,000 *Dunaliella* sp. cells for each larva during the first 4 days; ca 100,000 cells on days 5 to 8). Maximum growth rates occurred in airlift-operated raceways: SORGELOOS, BOSSUYT and BAEZA-MESA (personal communication) raised 5000 larvae l⁻¹ to the adult stage on dry *Scenedesmus* sp. or *Spirulina* sp. without renewal of the culture water within 2 weeks.

According to VON HENTIG (1971), larvae of *Artemia salina* grow best at 30° C and 15‰S, subadults at 20° C and 32‰S. Although hatching efficiency is higher in light than in darkness (p. 745), larvae grow faster in darkness than when cultured in continuous illumination (SORGELOOS, 1972). While the optimum temperature for larval growth is near 30° C, temperatures as low as 10° C, and as high as 37° C, are tolerated (BOND, 1937a; VON HENTIG, 1971).

Branchiopoda as Assay and Food Organisms

The euryplastic brine shrimp *Artemia salina* is hardly an ideal assay organism for assessing environmental quality. Nevertheless, several investigators have made use of cultured brine shrimp for testing biological consequences of man-made water pollution. CORNER and SPARROW (1956), for example, examined copper and mercury poisoning in *A. salina* and ZILLIOUX and co-authors (1973) investigated the effects of oil dispersants.

Although no marine animal lives on *Artemia salina* under natural conditions, the importance of the brine shrimp as food organism for other cultured animals is unique. Since GROSS (1937) and ROLLEFSEN (1939) introduced the technique of feeding fry of marine fishes *A. salina* nauplii, more than 85% of the marine animals cultivated thus far have been offered *A. salina* as food source—either together with other foods or, more often, as sole diet. In most cases, larvae of *A. salina* have been used.

Techniques for mass-producing *Artemia salina* as food organism have attracted considerable attention. We consider here techniques developed for separating egg shells and newly hatched nauplii, and for nauplii harvesting, as well as egg-shell contamination, continuous cultures, automatic feeders, and differences in brine shrimp quality and food value.

Separation of egg shells and harvesting of larvae

The shells of the resting eggs of *Artemia salina* are highly resistant to biodegradation. Hence, before harvesting, empty egg shells and larvae must be separated. Several harvesters have been developed which employ gravity or light gradients as a means of separating empty egg shells, unhatched eggs and nauplii (e.g. SHELBORNE and co-authors, 1963; LARSON, 1970; LENHOFF and BROWN, 1970; JONES, 1972; PERSOONE and SORGELOOS, 1972; BOYD, 1974; WARD, 1974; KINNE, unpublished). Five harvesters which have been used successfully over several years are described below.

LENHOFF and BROWN (1970) hatched *Artemia salina* eggs in conical plastic bags of 2-l capacity. The bags are provided with a metal-reinforced eye, and may be

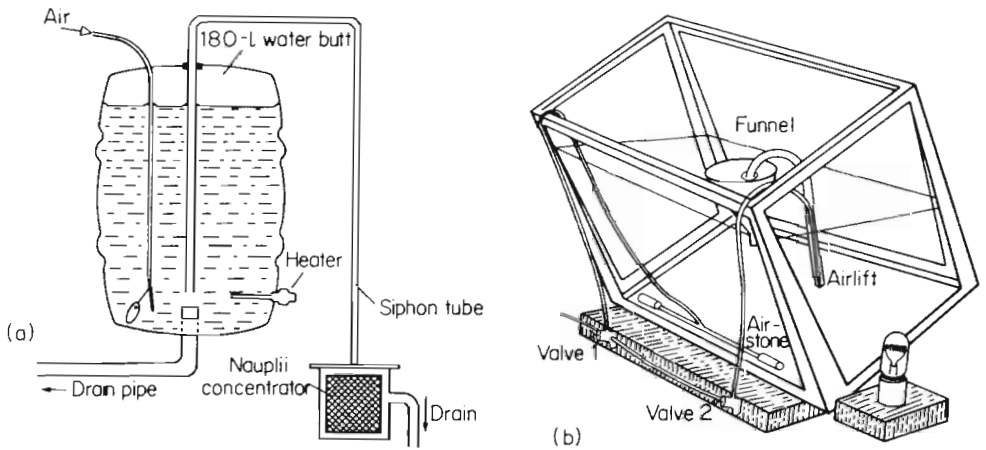

Fig. 5-30: *Artemia salina* harvesters. (a) Freshly hatched larvae are siphoned into a nauplii concentrator, and then resuspended in aerated sea water. (b) Closure of Valve 1 turns off the air flow, while a light attracts the larvae towards an airlift. After 15 mins, Valve 2 is opened, and the larvae are airlifted into a net. (a After JONES, 1972; reproduced by permission of Conseil International pour l'Exploration de la Mer; b after WARD, 1974; not copyrighted.)

hung from a ring stand. An aeration stone in the bottom of each bag is attached to a low-pressure air pump. The conical shape of the bags allows mild aeration while keeping most eggs suspended. Harvesting of larvae involves 3 steps: (i) The aeration stone is removed, and 10 mins are allowed for separation of hatched nauplii, empty egg shells and unhatched eggs. (ii) The hatched nauplii aggregate towards the bottom of the bag, immediately above the layer of unhatched eggs. (iii) The nauplii are siphoned off.

JONES' (1972) harvester consists of a 180-l glass-reinforced, plastic water butt and is fitted with a rubber lid, a 4.0-cm plastic drain pipe, a 500-W, thermostat-controlled heater and solenoid valve-controlled aeration (Fig. 5-30a). Connected with a side arm, the nauplii concentrator (30 cm long, 15-cm diameter) contains a removable nylon net (20 cm long, 15-cm diameter; 61- μ m aperture size) mounted in a net ring. The sea water used is ultraviolet-disinfected, aerated vigorously for good circulation and contains 200 ml of a 0.5 M solution of sodium carbonate for

pH adjustment. At 26° C, 200 ml of *Artemia salina* resting eggs are spread on the water surface. A time switch interrupts aeration and heating 1 hr before the operator arrives in the morning. This provides time for the empty egg shells to sink to the bottom, and for unhatched eggs to float to the top, leaving the main water mass occupied by swimming nauplii. After 60 to 75 mins the nauplii are then siphoned off, collected in the concentrator and resuspended in aerated sea water.

WARD'S (1974) harvester hatches 100 g of brine shrimp eggs per day (Fig. 5-30b). It consists of a 40-l aquarium, tilted forward at a 30° angle, so that the eggs tend to

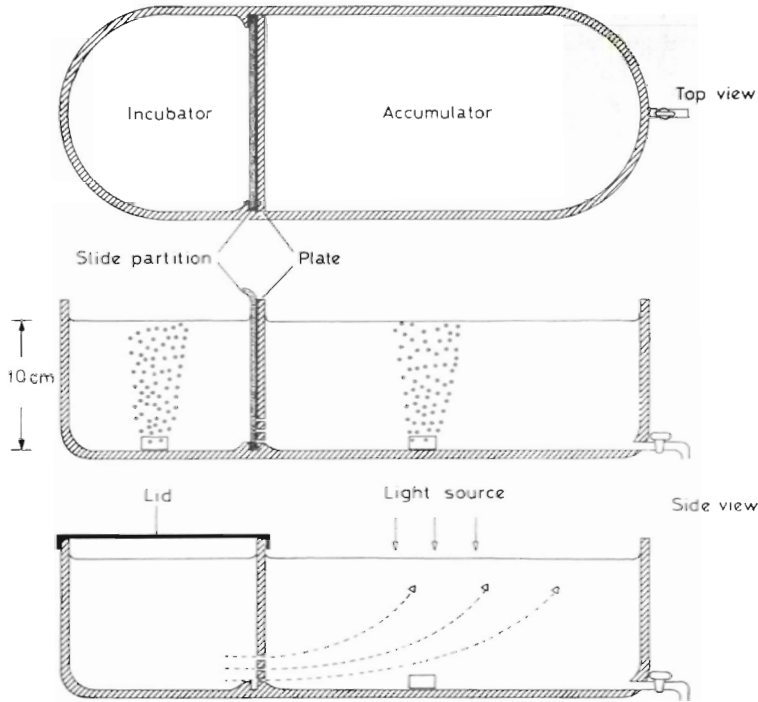

Fig. 5-31: *Artemia salina* harvester. With the slide partition closed, resting eggs are placed in the incubator and both the incubator and accumulator are aerated. After hatching, the aeration is turned off. Following the light gradient, the larvae aggregate in the accumulator from where they are collected. (Original.)

settle in the groove formed by front window and aquarium bottom. The hatcher requires 15 to 30 mins of daily maintenance. Aeration, via 2 air stones, keeps the eggs in suspension. When the larvae are ready for harvesting, the air supply is turned off and, within 15 mins, egg shells and unhatched eggs either float to the surface or sink to the bottom. The larvae are attracted to one side of the aquarium by a 7-W night light and airlifted into a net. About 90% of the larvae can be collected in 20 mins without contamination by egg shells and unhatched eggs.

KINNE (unpublished) used the brine shrimp harvester illustrated in Fig. 5-31 for 15 years; this unit is similar to that described by SHELBOURNE and co-authors (1963). The non-transparent PVC unit is subdivided by a plate. Immediately above the bottom, the plate contains 3 rows of small slits, which can be tightly closed or

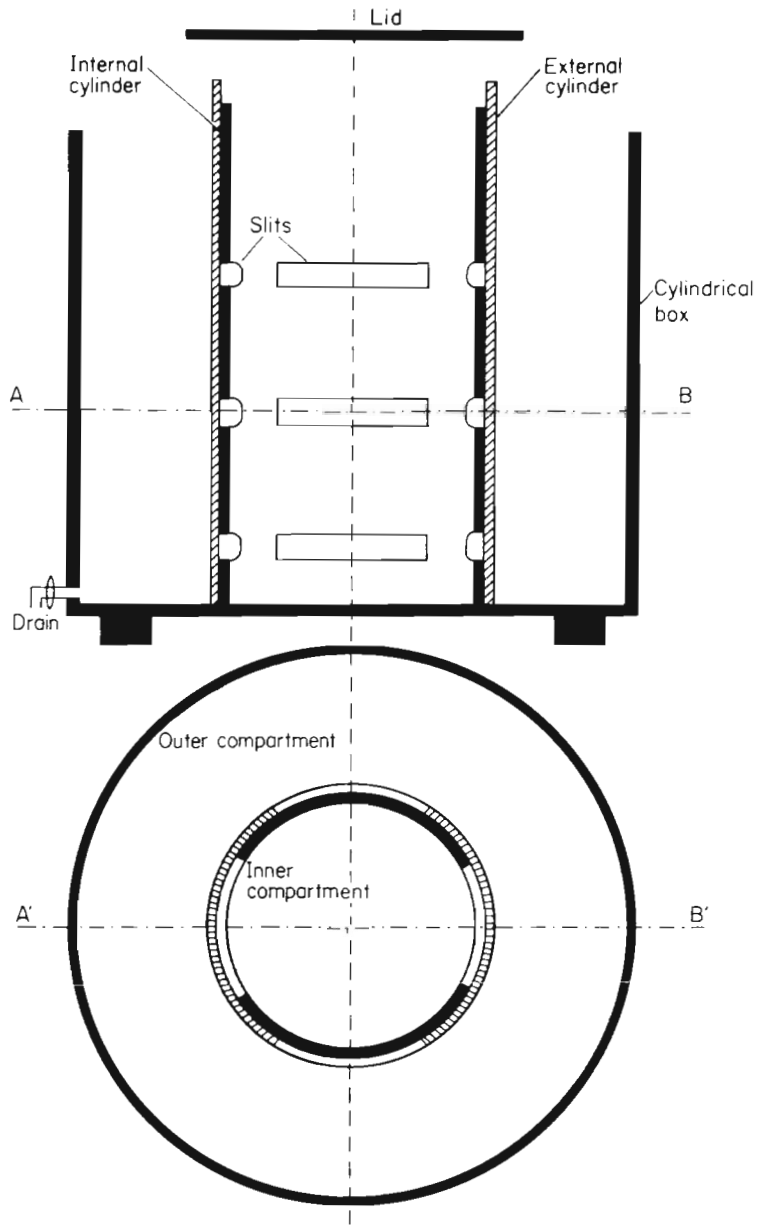

Fig. 5-32: *Artemia salina* harvester. Internal and external cylinders have slits which can be closed or opened by rotating the external cylinder. Opening the slits upon filling the inner compartment with the suspension of nauplii and cysts, illuminating the outer, sea-water-filled compartment and placing an opaque lid on top of the inner compartment forces the larvae to migrate, via the slits, into the outer compartment, where they are collected after once again closing the slits. (After SORGELOOS and PERSOONE, 1975; modified; reproduced by permission of World Mariculture Society.)

opened as the slide partition is moved down or up. With the slide partition open, the harvester is filled with sea water. The partition is then closed, and the resting eggs (5 to 10 g of eggs l^{-1}) are placed in the incubator. Both incubator and accumulator are now aerated. After hatching, the air flow is turned off, the slide partition lifted out, the incubator covered by a light-tight lid, and a light source placed over the accumulator. Within 10 to 15 mins, most larvae migrate from the incubator through the plate slits into the accumulator, where they can be harvested, after re-installing the slide partition, by (i) plankton gauze netting, (ii) light-trapping and subsequent airlift transport, or (iii) draining the accumulator water through a hand net. The system is easy to operate, yields high hatching percentages and has a separation efficiency of about 85 to 95%.

Table 5-38

Comparative efficiencies of 4 *Artemia salina* hatchers (Based on SORGELOOS and PERSOONE, 1975; modified and extended)

Efficiency parameters	RILEY (1966) (based on SHELBOURNE and co-authors, 1963)	JONES (1972)	SORGELOOS and PERSOONE (1975)	KINNE (unpublished)
Hatching system:	Rectangular box	Plastic water vat	Funnél-shaped glass cylinder	Oval bowl
Temperature:	Not known	26° C	28° C	25° C
Origin of eggs*:	Utah (USA)	California (USA)	Utah (USA)	California (USA)
Maximum input of eggs ($g\ l^{-1}$):	Ca 0.3†	Ca 0.6†	14	Ca 10
Output efficiency (nauplii g^{-1} eggs):	71,000 to 360,000	73,000	143,000	100,000 to 150,000

* Optimal hatching efficiency for Utah eggs: ca 70% (VON HENTIG, 1971; SORGELOOS, 1973c); for California eggs: ca 90% (SORGELOOS, 1973c).

† This figure was calculated on a basis of 0.60 g eggs in 1 ml.

SORGELOOS and PERSOONE (1975) use harvesters which facilitate light-triggering (p. 745). They prefer hatching cylinders over flat-bottom, rectangular containers (avoidance of egg sedimentation and 'corner-seeking behaviour' of the larvae). The harvester of PERSOONE and SORGELOOS (1972) gives a separation of more than 90%. An improvement of this apparatus which facilitates large-scale operations (SORGELOOS and PERSOONE, 1975) is illustrated in Fig. 5-32. The device is made entirely of non-transparent PVC and has 3 parts: (i) An internal cylinder glued to the bottom of a cylindrical box with horizontal slits at opposite sides. The slits are about 1 cm wide and their total length is slightly less than a quarter of the circumference of the cylinder. (ii) A rotatable, external cylinder, fitted closely over the internal cylinder and provided with exactly the same slits. (iii) A PVC lid for the internal cylinder.

The device is operated as follows: The external cylinder is rotated so as to completely separate the slits of both the internal and external cylinders, thus partitioning inner and outer compartments. Towards the end of the hatching period,

the inner compartment receives the mixed suspension of empty egg shells, unhatched eggs and freshly hatched nauplii, while the outer compartment is filled with sea water. Water levels in inner and outer compartments must have exactly the same height. A lid is placed on top of the internal compartment, a light source is set above the harvester, and the external cylinder is slowly rotated 90° to assure maximum communication between neighbouring slit pairs. The nauplii in the darkened inner compartment migrate into the lighted external compartment. After 10 to 15 mins, the external cylinder is rotated back into the closed position, and the nauplii are collected by netting or drainage.

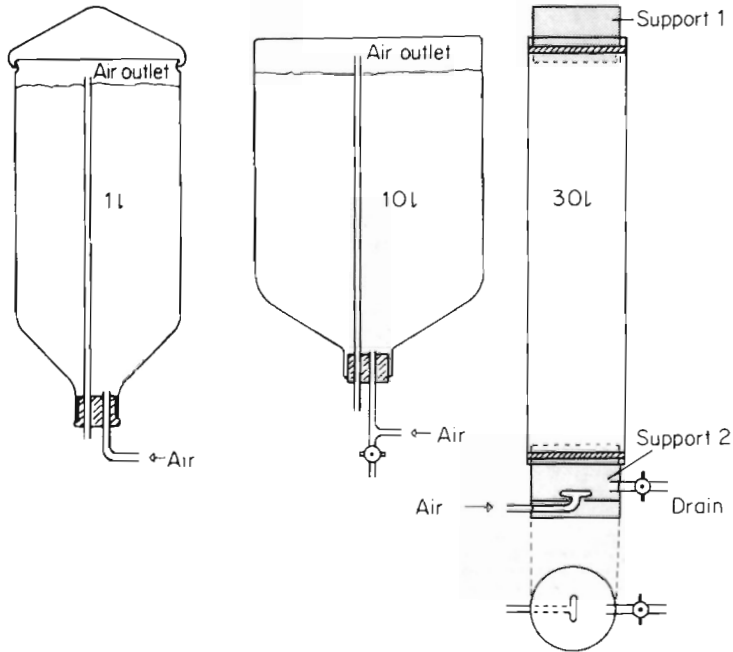

Fig. 5-33: Culture containers for raising high densities of *Artemia salina* larvae. (After SORGELOOS, 1973a; modified; reproduced by permission of Elsevier Scientific Publishing Company, Amsterdam.)

A comparison of the efficiencies of the harvesters used by RILEY (1966; based on SHELBOURNE and co-authors, 1963), JONES (1972), SORGELOOS and PERSOONE (1975) and KINNE (unpublished) is presented in Table 5-38.

High-density cultivation of *Artemia salina* larvae has been achieved in a raceway (SORGELOOS, BOSSUYT and BAEZA-MESA, personal communication) and in culture containers of 3 different sizes (SORGELOOS, 1973a). At 28° C, SORGELOOS grew 2000 nauplii in 1-l containers, 25,000 in 10-l containers and 50,000 in 30-l containers (Fig. 5-33). Using frozen *Dunaliella* sp. or dried *Scenedesmus* sp. cells as food, he obtained growth rates comparable with the highest values reported in literature. Freezing or drying of food algae allows harvesting of great masses at a convenient season, and storage for later use. The 1-l and 10-l containers are operated upside-down; the former (serum bottles) can be hung up conveniently by their metal

clamp; the latter must be mounted in frames. The 30-l container is composed of a 2-m long, 16-cm diameter, polyethylene cylinder made of 0.2-mm plastic sheet with short PVC supports fitted to both ends. Support 1 remains open; support 2 accommodates an air inlet and a stop-cock drain.

Discussing previous attempts to mass culture *Artemia salina* larvae and sub-adults, SORGELOOS and PERSOONE (1975) point out that: (i) most systems ac-

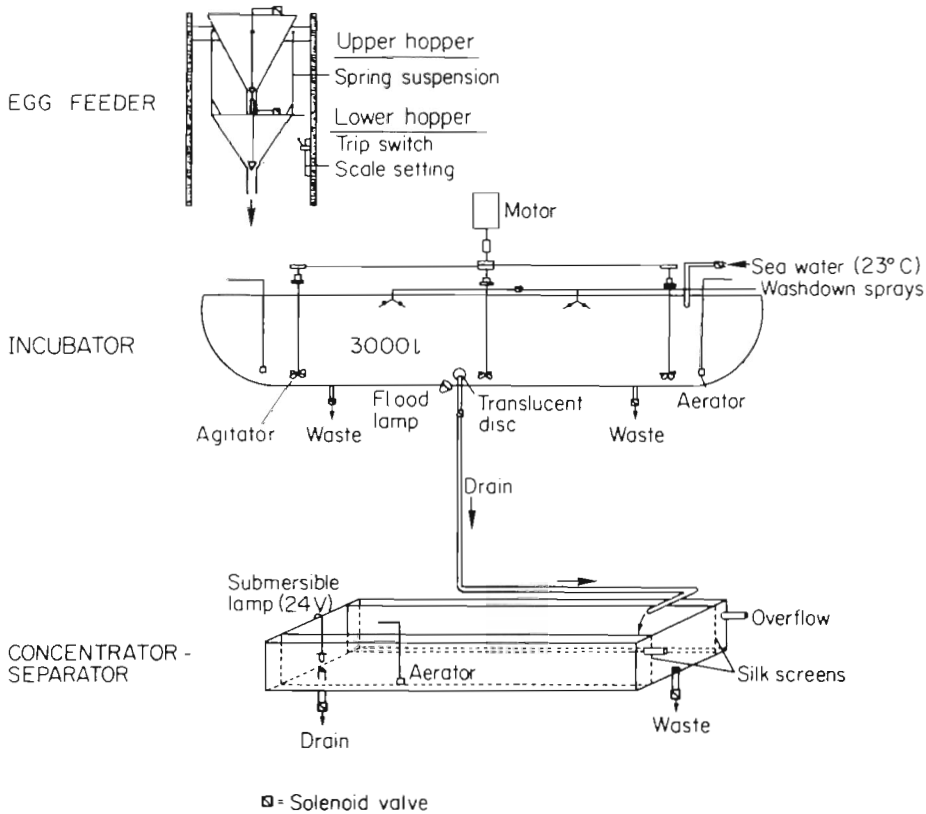

Fig. 5-34: Automatic mass-production system for *Artemia salina* nauplii. (After SHELBOURNE, 1969; modified; reproduced by permission of Gordon and Breach, New York.)

commodate only low population densities; (ii) continuous aeration is detrimental to the larvae (DUTRIEU, 1960; NIMURA, 1967); (iii) large-scale production of the commonly used foods, i.e. living algae, is still expensive. In Japan, *A. salina* larvae are mass cultured in population densities of 6 individuals l^{-1} on a diet of mixed soybean powder and flour. However, growth rates are poor (1.5 to 6.5 mm in 13 days) and the mortality rate is high (NIMURA, 1967). In other Japanese mass culture projects, the freshwater alga *Chlorella* sp. was used as food (MOCK, 1971), but details are unavailable. In the USSR, primitive mass cultures in ponds, fertilized to enhance bacterial and algal growth (IVLEVA, 1969), have supported maximum

densities of 400 individuals l^{-1} . SICK (1976) obtained maximum growth and assimilation efficiencies in *A. salina* populations fed *Chlamydomonas sphagnicolo*, *Dunaliella viridis* or *Platymonas ellipta*.

Automatic nauplii mass-production systems have been employed by SHELBOURNE (1969) and NASH (1973). Developed and improved over several years, SHELBOURNE's system (Fig. 5-34) is installed in a dark, temperature-controlled room and operates fully automatically. The amount of resting eggs added to the system ($0.75 \text{ g } l^{-1}$) is controlled by an egg feeder: upon a signal relayed to a magnetic

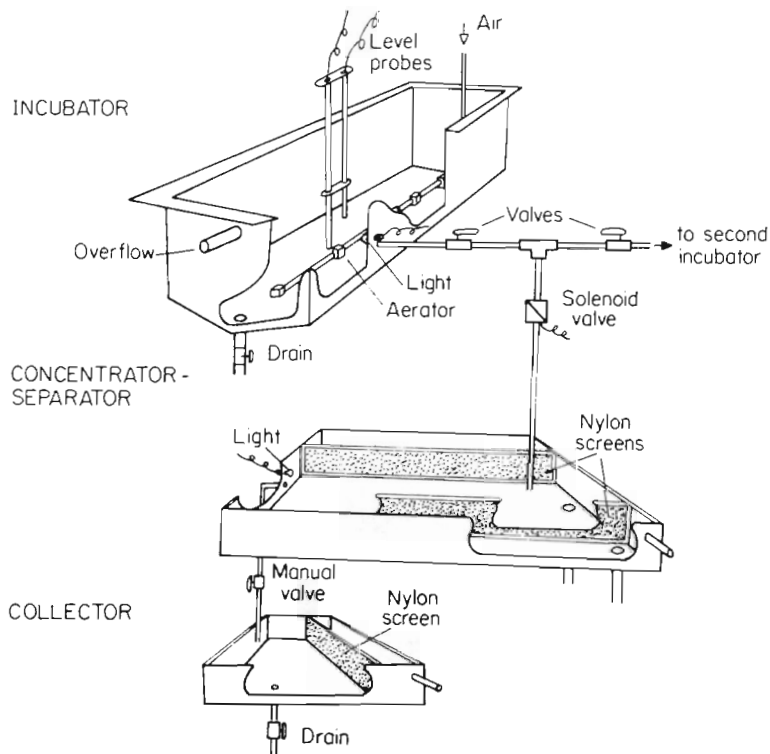

Fig. 5-35: Semi-automatic mass-production system for *Artemia salina* nauplii. (After NASH, 1973; modified; reproduced by permission of Elsevier Scientific Publishing Company, Amsterdam.)

valve, the large, upper hopper dribbles eggs into the smaller, lower hopper. When a preset weight is reached in the spring-suspended, lower hopper, the egg dribbling is stopped and the eggs in the lower hopper are discharged into the sea-water filled, fibre-glass incubator below. The incubator (e.g. a domestic bath) is fitted with 3 agitation propellers and 2 aerators. After 40 hrs, the separation process begins: propellers and air supply are stopped; after a brief settling period, a flood lamp in a translucent disc is switched on and begins to attract the nauplii; 20 mins later, a magnetic valve opens and drains the concentrated nauplii into the concentrator-separator. The incubator gives 80 to 90% hatching rates with high-quality San Francisco eggs. Utah eggs are heavier and require stronger agitation and aeration. About half of the incubator must be emptied in order to collect about 95% of the

nauplii. In the concentrator-separator (a plywood box with epoxy resin, 243 × 90 × 23 cm deep), two lateral silk frames screen excess water before it leaves through a surface overflow. The heavily concentrated, clean nauplii suspension is aerated and—after a further light-trap separation—discharged into a final receiver containing heavily aerated sea water. From here, the nauplii are ready to be fed to fish larvae. In one production cycle, two incubators are used alternately. The incubators are cleaned by two rotating, timing-device-operated, wash-down sprays.

The similar, semi-automatic, mass-production system of NASH (1973) is capable of producing 250 million nauplii daily at an egg load of 1 g l⁻¹ (Fig. 5-35). The system operates on a 48-hr cycle using two incubators with a common separator. A 36-hr incubation period leaves 12 hrs for cleaning and other functions. Maximum production was obtained at 24° C in 35‰ S.

Two devices have been used for counting the number of *Artemia salina* nauplii administered to a given culture: the electronic apparatus described by MITSON (1963) and a modification of that apparatus yielding more accurate counts (VAN OUTRYVE and SORGELOOS, personal communication).

Egg-shell contamination

The resting-egg shells of *Artemia salina* are often heavily contaminated with associated micro-organisms and pollutants. Degree and type of contamination vary with the origin of the eggs. Only careful sterilization and pollution tests can reduce the danger of culture contamination (see also Chapter 7).

The following procedure for cleaning commercially available *Artemia salina* eggs of most of the non-living debris has been recommended by LENHOFF and BROWN (1970): (i) Place 1 l of eggs in a 4-l beaker, and bring the volume up to 3 l with cold 0.2 M NaCl. Let the slurry stand for several hours at about 4° C; keep the temperature low to prevent premature egg development. (ii) Repeat the 0.2 M NaCl wash until a clear solution is obtained. (iii) After the final wash, bring the volume up to 4 l with saturated NaCl solution. Because this treatment eventually dehydrates the eggs, and thereby slows their development, the remainder of this step may be carried out at room temperature. In saturated NaCl, the eggs float and heavy contaminants, particularly sand, settle out. Aspirate off these contaminants by inserting a glass suction tube to the bottom of the beaker. For smaller batches, a separatory funnel can be used. Repeat the flotation procedure as many times as necessary to remove extraneous material (2 washes usually suffice). (iv) As the eggs settle, draw off any clear solution and store the eggs at 4° C in the saturated NaCl solution. These dehydrated eggs will retain their viability for months.

For sterilization of *Artemia salina* resting eggs, LENHOFF and BROWN (1970) suggest replacing the saturated NaCl with 3 l of cold 0.2 M NaCl containing 70 ml l⁻¹ of 'Antiformin' solution (NAKANISHI and co-authors, 1962). Antiformin solution is prepared by dissolving 5.68 g NaOH and 3.2 g Na₂CO₃ in 100 ml of a 5.25% sodium hypochlorite solution. Stir the egg slurry with a glass rod every 5 mins for 15 mins (do not use a magnetic bar stirrer, as it damages the eggs). Allow the eggs to settle, and then decant the resultant solution. The colour of the solution is caused by release of material from the egg shells. Repeat this procedure, decant the antiformin solution and wash the eggs in 4 successive changes of cold 0.2 M NaCl. Store the eggs at 4° C for 3 to 4 days, changing the solution several times each day

to assure complete removal of the antiformin. For final storage of the treated eggs, replace the 0.2 M NaCl solution with sterile, saturated NaCl, and store at 4° C. The antiformin treatment removes the abundant bacterial and fungal populations usually associated with the resting eggs.

Artemia salina resting eggs may also be sterilized by application of thiomersal ('Merthiolate'), described by PROVASOLI and SHIRAISHI (1959) (see also Chapter 5.11). However, LENHOFF and BROWN (1970) found nauplii hatched from such eggs to be toxic.

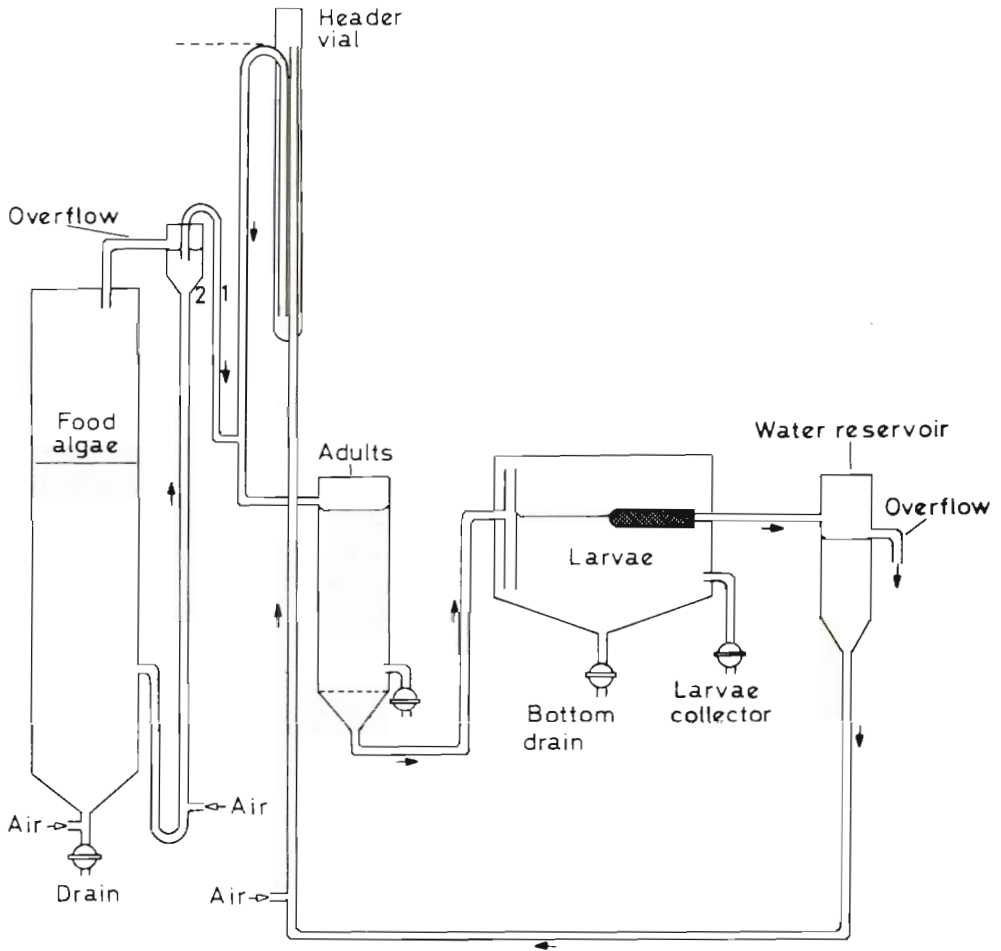

Fig. 5-36: Continuous, self-sustained, brine-shrimp culture system. This system can also be used for cultivating other algae-feeding plankters. (After SORGEL00S and PERSOONE, 1973; modified; reproduced by permission of E. Schweizerbart'sche Verlagsbuchhandlung.)

Continuous cultures

A few culture systems have been developed, in which adult *Artemia salina* produce larvae which can be continuously harvested. The continuous, self-sustained brine shrimp culture system of SORGEL00S and PERSOONE (1973) has been operated trouble-free for months (Fig. 5-36). It may also be used for *Daphnia magna* cultures

and for cultivating other small planktonic invertebrates. The system consists of 3 main Perspex cylinders containing food algae (cylinder diameter: 15 cm; height: 140 cm), adults (10, 30 cm), larvae (30, 20 cm), as well as of 2 accessory cylinders: a water reservoir (7, 20 cm) and a header vial (3.5, 45 cm). The food-algae container is illuminated and vigorously aerated to provide carbon dioxide and water movement. Every 30 mins, a small air pump is automatically switched on for 5 mins; it lifts water from the reservoir to the header vial. At the dashed-line level, a siphon begins to transport water into the adult compartment. This water flow creates a negative pressure in siphon 1 which, after a short time, starts to empty vial 2. Thus, each half hour, a small amount of food algae is made available to the adult brine shrimp and their progeny. At the same time, water, larvae and some algae pass through a screen (broken horizontal line in the adult compartment), and are transported into the larvae compartment. Interrupted, sequential airlift operation gently transports the offspring produced, and provides sufficient food for the larval population. The offspring can be harvested by operating the larvae-collector drain. After complete drainage of the larvae compartment (bottom drain) and refilling with fresh culture water, one can collect offspring after 1 day, all larvae being 24 hrs old at most.

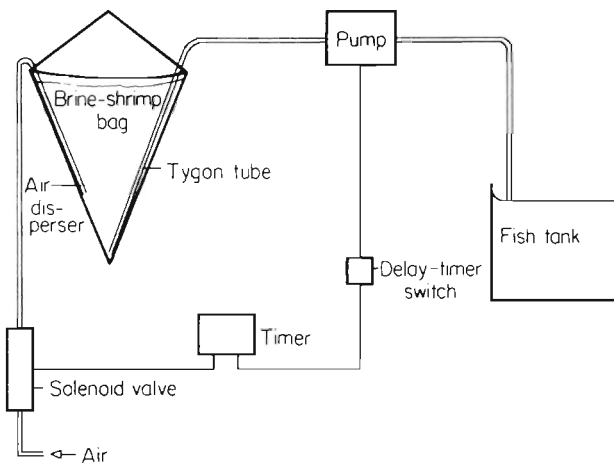

Fig. 5-37: Automatic feeder using nauplii of *Artemia salina* as food source. Newly hatched nauplii are pumped into the fish tank at timer-controlled intervals. (After SMITH and co-authors, 1974; modified; not copyrighted.)

Automatic feeders

The number of man-hours required for maintaining large cultures of animals that feed on *Artemia salina* or similar live foods can be substantially reduced by employing automatic feeders. Two examples are described below.

For feeding newly hatched *Artemia salina* to cultured fishes, SMITH and co-authors (1974) used the automatic feeder shown in Fig. 5-37. Hatched in a series of

plastic bags hung on a wall hook, the nauplii are pumped by timer control into the fish tanks. After hatching, tygon tubing is inserted down to the bag's base. The aeration in the bag is discontinued by a solenoid valve shutting off the air flow, and thus the nauplii are allowed to aggregate in the tapered end of the hatching bag. The peristaltic pump turns on 8 mins later and, for 7 mins, transports nauplii into the fish tank. The pump is then turned off, and the valve opened again. The time intervals for operation can be adjusted to the experimenter's needs. After the larval supply of one bag is exhausted, the tygon tubing is moved to the next one.

An automatic feeder that discharges known and, if desired, variable portions of live or frozen adult brine shrimp has been developed by SERFLING and co-authors (1974b). Constructed of Plexiglas, the feeder (Fig. 5-38) consists of (i) a rotating shaft—attached at one end to a timer—to which a cylinder with spokes is secured;

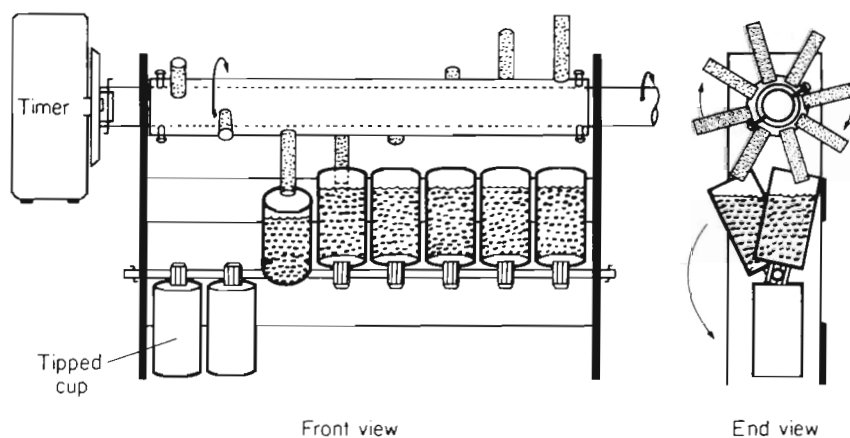

Fig. 5-38: Automatic feeder using live or frozen *Artemia salina* as food source. One timer rotation in 24 hrs empties the cup contents into the culture tank below (not shown) at 3-hr intervals. (After SERFLING and co-authors, 1974b; modified; reproduced by permission of Elsevier Scientific Publishing Company, Amsterdam.)

(ii) a frame with 8 30-ml cups, which are periodically tipped and thus emptied into a culture tank below. A series of 4 such 8-cup feeding units is operated by one rotating shaft, and each unit is centred exactly over one of the 4 culture tanks served. Usually, the timer rotates once in 24 hrs, thereby tipping 1 cup every 3 hrs. By changing rotation speed and food-cup number, the feeding interval can be adjusted to any desired pattern.

The automatic brine shrimp feeder developed by SCHIMMEL and HANSEN (1975) is claimed to be more useful than the feeders described by BENOIT and co-authors (1969) and ANDERSON and SMITH (1971). It delivers equal quantities of food and records the number of feedings. The electrically-operated device may be set to cycle 1 to 12 times day^{-1} . The feeder consists of an all-glass container ($32 \times 4 \times 14$ cm deep), 2 float switches (a, b), an oscillating pump, a stainless steel solenoid valve (SV) and an electrical timer and counter (Fig. 5-39). The container is divided into 7 compartments, 6 of which hold 100 ml each. The timer-controlled pump fills the 6 compartments with nauplii and water from a reservoir; part of the mixture

finally cascades into the large compartment (c), raising float switches a and b. On rising, b opens and deactivates the pump, while a closes. This closing, however, does not cause the feeder to empty until the timer activates the solenoid valve and counter. When the solenoid valve opens, drainage from compartment c creates a vacuum at the vacuum venturi (VV) which, in turn, starts the siphons in compartments 1 to 6. As compartment c empties, float switch a opens and switch b closes. The system is now ready for a new cycle.

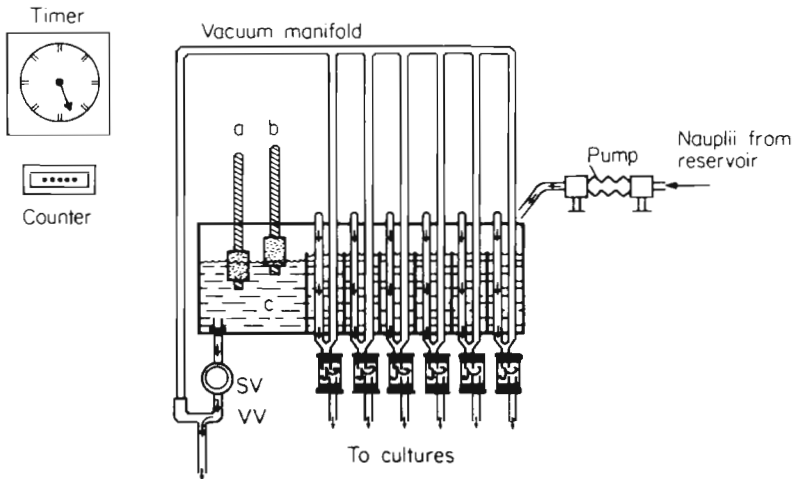

Fig. 5-39: Automatic feeder using live *Artemia salina* nauplii as food source. Upon timer action, the contents of 6 compartments are siphoned into cultures; a counter records the number of feedings. (After SCHIMMEL and HANSEN, 1975; modified; reproduced by permission of the Fisheries Research Board of Canada.)

Differences in quality and food value

An alarming, but apparently little-noticed, statement has been made by KUENEN (1939), who conducted extensive comparative studies on taxonomy and physiological variability of *Artemia salina* from different locations in the world. KUENEN argues that differences in brine shrimp origin may affect the outcome of experiments conducted on animals who receive such brine shrimp as food organism. He postulates that, in some cases, differences in larval quality and food value may influence the responses of cultured animals more significantly than the different environmental circumstances under which the experiments are carried out. In view of the worldwide use of brine shrimp as food organism, KUENEN's warning deserves critical examination.

Eggs of *Artemia salina* from San Francisco were found to be significantly smaller (mean diameter 194 μm) than those from Utah (209 μm) (WICKINS 1972). However, 48 hrs after the nauplii had hatched, no statistically significant difference in their mean lengths (0.4 to 0.9 mm) could be detected. Functional and structural differences in *A. salina* populations collected from different habitats all over the world have also been reported by SORGELOOS and co-authors (in press).

HAUENSCHILD (1954, 1956a) and WERNER (1968) have warned against using freshly hatched larvae of *Artemia salina* as a food source for cnidarians, because, at this stage, they contain high-energy reserve substances, which may be detrimental when taken up in large quantities. The larvae should be at least 3 to 5 days old (ca 20° C) before being used as a food source.

Certain differences in the quality and food value of *Artemia salina* may be due to pollution. According to SLOBODKIN (1968), *A. salina* eggs from Utah (USA) produced nauplii which proved to be toxic for plaice larvae. SLOBODKIN traced this toxicity back to residual insecticides accumulated from surrounding agricultural regions near the Great Salt Lake in Utah, but he did not present details on the type or amount of the pesticides. Examining nutritional effects of *Artemia salina* obtained from different locations in the USA, BOOKHOUT and COSTLOW (1970) found that larvae of crabs *Rhithropanopeus harrisi*, *Hexapanopeus angustifrons*, *Libinia emarginata* and *Callinectes sapidus* survived better on brine shrimp nauplii hatched from California (USA) eggs than from Utah eggs. In addition, crab larvae fed California nauplii exhibited normal development, whereas all *R. harrisi* megalops and some *H. angustifrons* fed Utah nauplii showed structural abnormalities. BOOKHOUT and COSTLOW present evidence which indicates that the differences in food value of *A. salina* larvae may be due to different amounts of DDT present in *A. salina* nauplii from California and from Utah. They found about 3 times more DDT in *A. salina* nauplii from Utah than in those from California. The abnormalities recorded resemble DDT poisoning reported in juvenile and adult crabs. However, WICKINS (1972), who analyzed *A. salina* eggs and nauplii from San Francisco and from Utah (USA) for the presence of pesticides, heavy metals, carotenoids, sterols and fatty acids, concludes that none of the differences found could be labelled with confidence as the cause of the poorer food value of the nauplii from Utah.

Differences in the quality and food value of *Artemia salina* may also be related to the food taken up by the brine shrimp. Unfortunately very little is known about the effect of diet and environmental factors on the chemical composition of *Artemia salina*. After rearing *A. salina* on unialgal diets of *Phaeodactylum tricornerutum*, *Monochrysis lutheri*, *Platymonas tetrathele* and *Chlamydomonas* sp., HINCHCLIFFE and RILEY (1972) found the levels of various saturated acids to be comparatively constant, regardless of the food alga used. The proportions of palmitic acid recorded in *A. salina* (8 to 13%) closely resembled those in the algae (9 to 15%). Myristic-acid levels remained between 1.3 and 3.0%, even when up to 10% was present in the algal diet. In contrast, stearic-acid levels were always several times higher in the *A. salina* lipids than in those of the phytoplankters consumed. Oleic acid, the major fatty acid in *Artemia salina*, is presumably synthesized (HINCHCLIFFE and RILEY, 1972). In contrast to oleic and stearic acids, hexadecatetraenoic-acid levels are very low.

Newly hatched and 24-hr-starved *Artemia salina* nauplii from Utah were found to be unsatisfactory as food for larvae of the prawn *Palaemon serratus*, but Utah nauplii that had been fed *Isochrysis galbana* supported adequate prawn development (WICKINS, 1972). The poor food value of Utah nauplii was completely compensated for by allowing the nauplii to feed on *I. galbana* (1000 cells μl^{-1}) for 24 hrs. One litre of a suspension of *I. galbana* at an initial concentration of 300 cells μl^{-1}

provided enough algae for 10,000 Utah nauplii in 24 hrs to make them a satisfactory food source. Similar improvements in the food value of *A. salina* nauplii fed unicellular algae or yeast prior to their use as food organisms have also been reported by several other authors. It remains to be investigated whether algae or yeast provide life-supporting substances (e.g. vitamins, growth factors) or, less likely, whether they compensate for growth-inhibiting factors contained in the nauplii.

Newly hatched nauplii of *Artemia salina* undergo considerable changes in chemical composition as they grow. BENIJTS and co-authors (in press), for example, reported major changes in ash weight and lipid content, as well as a drastic decrease in nutritional value of unfed nauplii from the first to the third instar. Variations in the activities of digestive enzymes and protein contents of *A. salina* have been studied by SAMAIN and BOUCHER (in press). In order to provide food of comparable quality, hatching procedure and age at feeding must be standardized.

Branchiopoda: Conclusions

Among the branchiopods, the brine shrimp *Artemia salina* has received unique attention. This inhabitant of brine waters has become famous as food organism for a large variety of aquatic animals. The present review summarizes and evaluates methods for mass cultivation. It concentrates on egg incubation and hatching; rearing of larvae, subadults and adults; separation of egg shells and harvesting of larvae; egg-shell contamination; continuous cultures; automatic feeders; and food-quality value.

Differences in quality of *Artemia salina* obtained from different locations, reared under different environmental circumstances, or sustained on different diets may affect the outcome of experiments on animals fed *A. salina*. Such possibility as well as potential pollution of eggs due to chemicals or contamination due to micro-organisms must be more fully investigated.

For some marine animals, it is apparently difficult to digest *Artemia salina*. Its hard exoskeleton may resist digestive enzymes, especially under conditions of rapid passage through the intestine. In these cases, food uptake, digestion and absorption must be assessed separately, and over extended periods of time, before valid statements on food value can be made.

(b) Copepoda

Marine copepod populations rank high as key factors in food webs and ecosystems. Both benthic and planktonic Copepoda often establish large populations and may occur at high densities. Differences in functions and structures between species and among the life-cycle stages of conspecifics (Fig. 5-40) convey diversity in selecting food and in being selected as food by other animals. Feeding dynamics of copepods have been reviewed in Volume IV: CONOVER (in press).

Benthic copepods play important roles in many bottom communities and may decisively affect the exchange and flow patterns of energy and matter between sea bottom and adjacent free water. Planktonic copepods are of paramount ecological significance, especially as pelagic food-web links and as indicators of water-body characteristics. They serve as a major food source for numerous invertebrates and

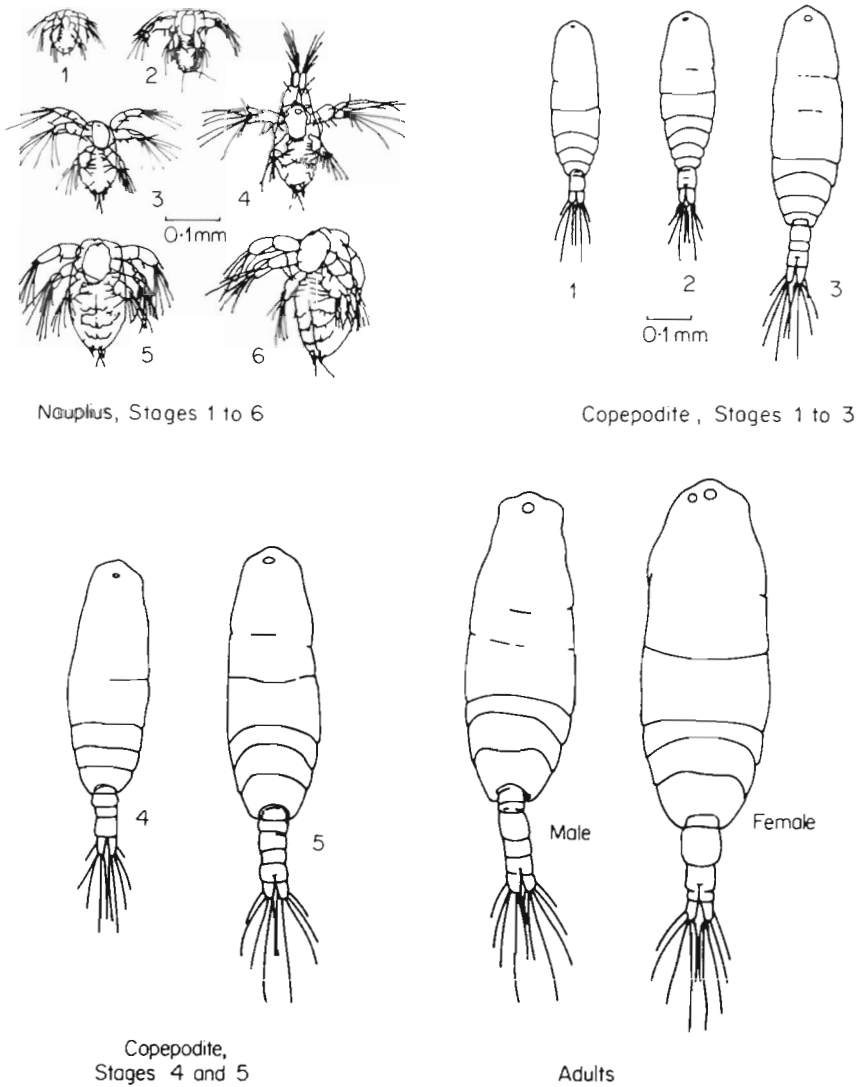

Fig. 5-40: *Acartia clausi*. Example of copepod life-cycle stages. (After KOGA, 1973; modified; reproduced by permission of the Plankton Society of Japan.)

fishes, including commercially important forms, and have great potential as assay organisms for sea-water-quality estimations.

Benthic Copepods

In general, benthic copepods are easier to cultivate than their planktonic counterparts. The representatives studied thus far exhibit less specific nutritional requirements and readily grow and reproduce under a large variety of culture conditions.

Tigriopus Species

Representatives of the genus *Tigriopus* have been maintained, raised or bred under laboratory conditions for periods of up to several years (e.g. FRASER, 1936; PROVASOLI and co-authors, 1959; PROVASOLI and SHIRAISHI, 1959; SHIRAISHI and PROVASOLI, 1959; COMITA and COMITA, 1966; SHIRAISHI, 1966; GILAT, 1967; NASSOGNE, 1970; TAKANO, 1971a). Indefinite cultures usually create no problems. In regard to environmental and nutritional requirements, most *Tigriopus* species are rather euryplastic.

Tigriopus brevicornis has been cultivated by COMITA and COMITA (1966) in glass dishes with filtered sea water (ca 11° C). One female was placed in a dish of 25 ml capacity containing 10 ml of water. Culture dishes were cleaned each day and the faecal pellets produced counted. For egg-sac removal, the ovigerous female was isolated in a drop of water on a microscope slide and the sac carefully separated (no details given) without apparent ill-effect. Egg sacs were incubated in membrane-filtered sea water. The food alga *Phaeodactylum tricornerutum* was offered daily at concentrations of 1, 10, 50 or 100 cells mm⁻³. At 1 cell mm⁻³, egg production ceased after 1 or 2 days; at 10 cells mm⁻³, after 9 days (Fig. 5-41); at 50 and 100 cells mm⁻³, egg production remained rather constant (5.14 eggs day⁻¹ and 7.66 eggs day⁻¹, respectively). When food concentration was increased to 100 cells mm⁻³ at the three lowest levels, egg production increased. In general, total egg number and total faecal-pellet number produced per *T. brevicornis* correlated well with the food density offered. In females fed 100 cells mm⁻³, temperature (10°, 15°, 20° C) affected the mean number of eggs per sac but slightly; average time required for hatching was 10.2 days at 10° C; 4.9 at 15° C; 3.1 at 20° C. At 18° C, *T. brevicornis* requires 19.5 days to grow from egg to adult (NEUNES and PONGOLINI, 1965).

Tigriopus fulvus tolerates very extreme environmental and nutritional conditions. In a sealed jar, half-filled with sea water and without added food, a small population survived for 2 years (FRASER, 1936). Another laboratory population tolerated salinities down to 8‰S (BOND, 1937b). Properly fed cultures survive indefinitely. At room temperature, females carry their first egg sacs within 7 to 10 days; the eggs hatch 5 to 15 days later. *T. fulvus* feeds on a large variety of unicellular algae (e.g. *Platymonas subcordaeformis*, *Nitzschia closterium*), decaying matter (e.g. seaweeds or even a piece of cheesecloth) and, probably, on micro-organisms such as bacteria and yeast.

The common coastal rock-pool harpacticoid *Tigriopus japonicus* can be bred on a variety of diets. PROVASOLI and co-authors (1959) have offered species of *Rhodomonas* + *Isochrysis*; *Platymonas* + bacteria; *Isochrysis* or *Chroömonas* + vitamins or glutathione. COMITA and COMITA (1966) used uni-algal cultures of *Phaeodactylum tricornerutum*. SHIRAISHI (1966) obtained indefinite bacteria-free cultures of *T. japonicus* with a mixture of *Rhodomonas lens* and *Isochrysis galbana*, but his cultures died after several generations if offered uni-algal diets. A mixture of vitamins and/or glutathione compensated for such nutritional inadequacy. TAKANO (1971a) fed a mixture of wheat and soya flour (1:1 by weight) and found this sufficient to maintain at least 12 generations; over long periods, a mixture of cereal flour and unicellular algae yielded the best results. According to TAKANO, uni-algal cultures of *Cyclotella nana*, *C. cryptica*, *Phaeodactylum tricornerutum* and

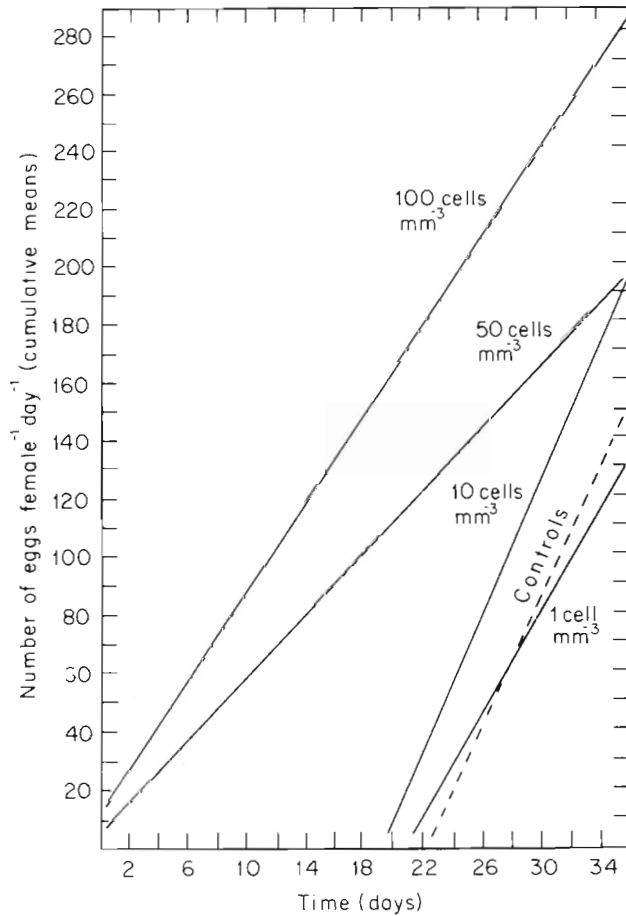

Fig. 5-41: *Tigriopus brevicornis*. Number of eggs produced female⁻¹ day⁻¹ at four concentrations of the food alga *Phaeodactylum tricornutum* and by starved females (controls). After 19 days, controls, as well as 1- and 10-cell-level cultures, received 100 cells mm⁻³, while the 50- and 100-cell-level cultures were continued unchanged. 11° C. (After COMITA and COMITA, 1966; modified; reproduced by permission of Allen and Unwin, Ltd.)

Nitzschia closterium were all satisfactory. TAKANO used glass aquaria as culture containers (non-sterile conditions, 15°–27° C). He obtained a minimum generation time of 12 days (1 day precopulation, 3 days egg development, 8 days for growth of juveniles to sexual maturity). Usually, 20 to 35 nauplii were produced per brood, and a maximum of 11 broods per female. Some dry foods—such as starch, rice bran, fish meal, trout pellets, 'WAKAMOTO' or dried *Chlorella* sp.—supported growth and reproduction in cultured *T. japonicus* (HANAOKA, 1973). In test tubes, the number of copepodite II and older stages increased to 250 individuals ml⁻¹ after 40 days.

Information on sex determination in cultivated *Tigriopus japonicus* has been presented by TAKEDA (1939, 1941a, b, 1948), as well as a study on thermal adaptation (TAKEDA, 1954).

Tisbe Species

Similar to *Tigriopus*, the harpacticoid genus *Tisbe* comprises easy-to-cultivate, hardy species. A number of *Tisbe* species have been shown to represent excellent material for experimental studies, notably on (i) population dynamics, (ii) genetics including speciation (Volume II), (iii) interspecific dynamics in artificial microcosms (this volume, Chapter 6), (iv) ecological *in situ* dynamics in marine sediments (Volume IV), and (v) responses of marine animals to water pollutants (Volume V). Cultivation methods for members of *Tisbe* species have been presented, for example, by LWOFF (1927), JOHNSON and OLSON (1948), BOCQUET (1951), INOUE and AOKI (1969), VOLKMANN-ROCCO and FAVA (1969), VILELA (1969), BATTAGLIA (1970), TAKANO (1971b) and HOPPENHEIT (1975); for further information consult Table 5-45.

Tisbe clodiensis has been cultivated by BATTAGLIA and FAVA (1968), BATTAGLIA and FINCO (1969), BATTAGLIA and VOLKMANN-ROCCO (1969), LAZZARETTO-COLOMBERA and POLO (1969), and *T. reluctantans* and *T. persimilis* by VOLKMANN-ROCCO and FAVA (1969), under conditions similar to those described for *T. reticulata* (p. 766).

Accommodated in 150-ml Griffin beakers containing 100 ml of sea water filtered through No. 20 mesh silk bolting cloth, *Tisbe furcata* has been bred by BARR (1969). The filtering left sufficient particulate matter to nourish the copepods. According to BARR, weekly culture-water renewal made it unnecessary to add other food. She placed 3 adults in each beaker. Nauplii were not removed, allowing each population to attain the carrying capacity of the container (about 100–200 copepods of all stages). Aside from weekly debris removal and water replacement, the cultures required little attention. At 3° to 8.5° C, incubation periods ranged from 5 to 16 days (average 11 days), naupliar periods from 1 to 16 days (average 11 days), and copepodid periods from 10 to 68 days (average 28 days). According to JOHNSON and OLSON (1948), at 17° to 21° C, the average incubation period of *T. furcata* amounts to 2.5 days, the average naupliar period to 5 days.

In exploited *Tisbe holothuriae* populations (weekly removal of 10, 30, 50, 70 or 90% of the individuals present), HOPPENHEIT (1975) studied population dynamics and the effect of water-renewal rate under conditions of a surplus food (dried mussel flesh) supply. Each population was accommodated in 200 ml of water (22° C; 30‰S), and populations with up to about 12,000 specimens, mainly nauplii, could be maintained. A reduced rate of water renewal (50% instead of 90% per week) resulted in a reduction of mean population density; adult and copepodid densities decreased at maximum exploitation, but nauplii density was lowered at all exploitation levels. Stable mean population sizes were maintained by all populations. *T. holothuriae* kept in small volumes of culture water (200 cm³) by GILLET and GUÉRIN (in press) grew better on food of predominantly animal origin ('Tetramin') than on a purely plant diet ('Cérophyl'). If kept together with *Capitella capitata*, *T. holothuriae* populations developed less well than without this polychaete.

Tisbe reticulata can be bred easily; it has a short life cycle and produces numerous offspring. After collection from benthic algae (species of *Ulva*, *Enteromorpha* or *Zosteraceae*), BATTAGLIA (1970) transferred *T. reticulata* to a large glass container and exposed them to darkness. Gradual diminution of oxygen and localized illumination cause the copepods to aggregate and facilitate transfer by pipetting. *T. reticulata* feeds on a large variety of diets, e.g. algae, wheat grains, small pieces of invertebrates (annelids, molluscs, crustaceans) and fishes, rabbit red cells and faeces of *Nereis* sp.; apparently, bacteria are also consumed. BATTAGLIA employed a modification of the culture method introduced by BOCQUET (1951). Cup-shaped glass containers (6 cm in diameter, 4 cm high) are filled with 20 cm³ of filtered sea water, and suspensions of unicellular algae (species of *Dunaliella*, *Phaeodactylum* or *Nitzschia*) are added as food organisms. One or two fragments of *Ulva lactuca*, after washing in fresh water for 10 to 15 mins to eliminate associated organisms, serve as source of oxygen and, perhaps, as additional food. The food supply is renewed as desired, usually every 5 days. When the nauplii begin to hatch from the egg sacs produced, one or two very small fragments of a wheat grain, boiled for 20 mins in fresh water, are provided as source of carotenoids. For mass cultures, larger cup-shaped glass containers (10 cm diameter, 6 cm high, and containing 100 cm³ of sea water) are used.

At a temperature of 18° C, the nauplii of *Tisbe reticulata* attain adulthood in 8 to 15 days. Larval development includes 6 naupliar and 6 copepodite stages (the 6th copepodite stage, corresponding to the adult, is reached after 11 moults). Transferring the female to a new culture vessel immediately after egg-sac deposition reduces larval mortality (*T. reticulata* is sensitive to crowding) and permits collection and analysis of several hundred offspring from a single female (BATTAGLIA, 1970).

Other Species

The estuarine benthic calanoid *Gladioferens imparipes* was raised by TAKANO (1971b) in glass tubes (1.8-cm diameter; 18 cm long; 15 ml culture water; moderate light; non-sterile conditions; about 24° C). This southern-hemisphere copepod fed on *Phaeodactylum tricornutum*; it seemed to be entirely herbivorous. Minimum generation time was 15 days (development of fertilized eggs, 3 days; nauplius, 4 days; copepodite, 8 days). Culture conditions employed for some additional species have received brief attention from IKEDA (1973).

The deposit-feeding benthic copepod *Heterolaophonte* sp. has been sustained by GEORGE (in press) in sea-water-cornmeal agar using disposable Petri dishes as culture enclosures (for details consult p. 723).

Planktonic Copepods

Planktonic copepods have attracted more attention from experimental ecologists and from biological oceanographers than most other zooplankters. In the last few decades, several estuarine and coastal marine planktonic copepods have been maintained, raised and bred with considerable success. However, cultivation of truly oceanic forms has remained a challenge to the cultivator.

The easiest step in cultivating planktonic copepods is to hatch eggs of newly collected ripe females (e.g. McLAREN, 1966; McLAREN and co-authors, 1969). Hence, cultures have usually been started from hatchlings obtained by placing females which carry embryos in advanced stages of development in small culture enclosures containing habitat water. Such hatchlings adjust more readily to culture conditions than adults already acclimated to specific *in situ* conditions.

Pelagic copepods are collected by a strainer, by making short, slow plankton-net hauls, by sieving water pumped from the sea, or by scooping water using a pail. They are usually transferred from one container to the other by wide-mouthed

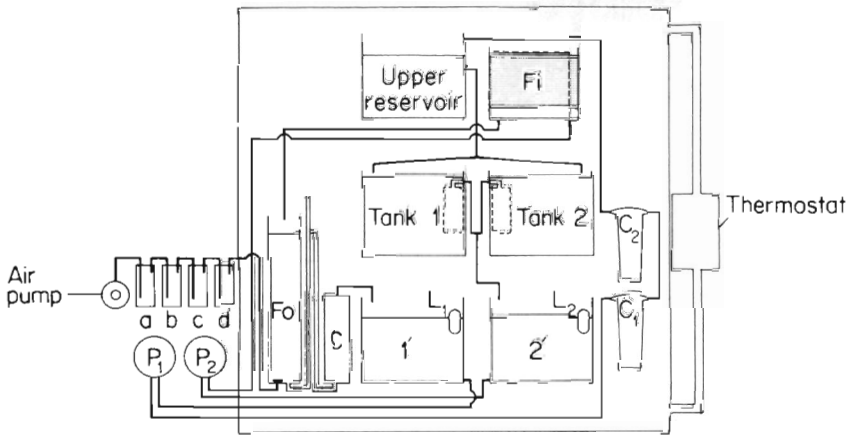

Fig. 5-42: System for cultivating planktonic marine copepods. Water flows from culture tanks 1 and 2 (30 l capacity each) through nylon netting to reservoir 2'. Pump P₂ transports the water to a glass-wool filter (Fi) from where it flows through a foam tower (Fo) into a charcoal tube (C) and then to reservoir 1'. A level switch (L₁) activates Pump P₁ which forces the water through two cartridge filters (C₁, C₂) and into the upper reservoir. a: charcoal tube; b: drying tube; c: empty jar; d: hydrator; L₂ level switch. (After ANRAKU, 1973; modified; reproduced by permission of the Plankton Society of Japan.)

pipettes. Equipment for cultivating marine planktonic copepods and related zooplankters has been presented in Chapter 2, pp. 227–244. A recently described recirculation system especially designed for cultivating planktonic marine copepods is illustrated in Fig. 5-42.

Acartia Species

Acartia clausi (Fig. 5-40) has been kept in culture by CORKETT (1968) and by NASSOGNE (1970), who fed a variety of unicellular algae, notably *Gymnodinium* sp., *Platymonas suecica* and *Phaeodactylum tricornutum* and employed the same culture method as for *Euterpina acutifrons* (p. 777). Starting with 150 copepods, NASSOGNE obtained ca 2000 adults after 6½ months and recorded a generation time of about 30 days at 18° C. GAUDY (1971) studied egg laying in cultured *A. clausi* under a variety of trophic conditions. He reports that the quality of the food algae

used (*Phaeodactylum tricorneratum*, *Skeletonema costatum*, *Dunaliella* sp., *Asterionella japonica* and *Ditylum brightwellii*) affects egg laying and fertility. Offering *Phaeodactylum tricorneratum*, *Skeletonema costatum*, *Asterionella japonica*, *Lauderia borealis*, *Ditylum brightwellii* and *Dunaliella* sp., GAUDY (1974) examined qualitative and quantitative aspects of feeding in *A. clausi*, as well as in *Calanus helgolandicus*, *Centropages typicus* and *Temora stylifera* (see also p. 796). The copepods studied by him also catch and ingest animal prey, e.g. nauplii of *Artemia salina*.

The coastal calanoid *Acartia tonsa* was the first holoplanktonic copepod cultured over several consecutive generations (ZILLIOUX and WILSON, 1964, 1966). The copepods were placed in non-aerated Pyrex crystallizing dishes covered with a glass plate. Dishes of 190 mm diameter (1500 ml culture water) allowed better survival than smaller ones. Sea water (membrane-filtered, ca 31‰S) was used unsupplemented and usually unbuffered (constant illumination, 650 to 1300 lux; 17° C). Food organisms were added from pure cultures at the time of each transfer to fresh culture medium, and thereafter at 3-day intervals: a mixture of approximately equal portions of *Isochrysis galbana*, *Rhodomonas* sp. and an unidentified diatom (5–6 μm). About 10,000 algal cells were provided per ml of copepod culture at the initial feeding, and about 4000 cells ml^{-1} at each subsequent feeding. This allowed a concentration of about 10,000 to 38,000 cells ml^{-1} to be maintained in the culture dishes at all times. The same feeding regime was used for nauplii, copepodites and adults. Generation time at 17° C is 21 to 30 days. *A. tonsa* was propagated by ZILLIOUX and WILSON (1964) through 5, by ZILLIOUX and WILSON (1966) through 12 filial generations.

The nauplii were not usually removed from the parental culture container until they had reached stage III or IV. About 40 nauplii were then transferred into a culture dish with fresh medium. After the females had attained sexual maturity, population density was further reduced to 5 females per 1500 ml in order to prevent excessive nauplii densities. In cultures containing more than 100 nauplii l^{-1} , development was usually disturbed and mortality increased. Transfers were made with pipettes (1- to 3-mm apertures), and the copepods released very slowly beneath the water surface. This operation required great care. Considerable mortality was further due to overproduction in dishes from which transfer could not be made in time (ZILLIOUX and WILSON, 1966). Prolonged maintenance under inadequate laboratory conditions may result in reduced vitality (retardation of maturation processes, reduction in reproductive potential, diminution in body size). Optimum densities of food algae have been determined in feeding experiments with ^{14}C -labelled phytoplankton (ZILLIOUX, personal communication). At densities of 50,000 cells ml^{-1} , *Rhodomonas baltica* was consumed with near-maximum ingestion rates. *Isochrysis galbana* was ingested rather slowly, until clumping occurred at concentrations well in excess of 50,000 cells ml^{-1} (this small alga is probably of greater importance to developmental stages). ZILLIOUX (1969a, b) supplied equal portions of *R. baltica* and *I. galbana* twice weekly, with initial total concentrations approximating 100,000 cells ml^{-1} .

HEINLE (1969b, 1970) and ZILLIOUX (1969a, b) succeeded in cultivating *Acartia tonsa* in artificial sea water (Chapter 2, p. 29). HEINLE (1969b) tried 'Instant Ocean' and 'Rila Marine Mix' with 25 mg sodium bicarbonate added l^{-1} ; both artificial sea waters were diluted with distilled water to give a salinity of 12‰

(Erlenmeyer flasks, 0.5 or 2.0 l, covered with black polypropylene to reduce irradiance and epiphyte growth; continuous light). *A. tonsa* grew well in 'Instant Ocean' but failed to grow in 'Rila Marine Mix'. Success of cultivation was measured by the ability of the artificial sea water to sustain a copepod population subjected to harvesting at 3- to 4- (20° C) or 5- to 7-day (15° C) intervals. A mixture of *Chaetoceros* sp., *Chlamydomonas reinhardtii* and *Isochrysis galbana* was used as food source. The copepods were fed 3 times a week with algae cultures that had attained optical densities varying from 0.08 to 0.13 at a wavelength of 550 nm. For 1 l of copepod culture, 12.5 ml of algal mixture were provided at each feeding. On the basis of this work, HEINLE (1970) proceeded to study population dynamics in exploited cultures. Maximum exploitation tends to increase the proportion of females; this, in turn, increases reproduction rates at low population densities.

ZILLIOUX (1969a) used 'Triton Marine Salts' to cultivate *Acartia tonsa* and *A. clausi*. This artificial sea water sustained high population densities for more than a year at 15° C in a recirculating culture system (Fig. 2-146, p. 234). Introduced as culture partner, the ciliate *Euplotes vannus* controls excessive bacterial growth and debris accumulation; at the same time, it serves as food source in addition to *Rhodomonas baltica* and *Isochrysis galbana*.

ZILLIOUX and GONZALEZ (1972) placed female *Acartia tonsa* into cylinders of 30-mm diameter and 60-mm height containing either filtered natural sea water or artificial sea water. The cylinders were designed so that the entire bottom could be inspected through an inverted microscope. Shed singly, the eggs sink quickly to the bottom. At low temperatures, 'resting eggs' are produced both by the laboratory and field populations. Resting eggs support winter survival and allow fast population recruitment in spring. Resting-egg production begins at 14.5° C; at 5° C, the entire population probably produces only resting eggs. For other records on resting-egg production in copepods consult p. 785.

Acartia longiremis was cultured by BARR (1969) with modest success. BARR employed the same method as for *Tisbe furcata* (p. 765); survival rates of *A. longiremis* increased after adding 0.7 to 1.4 ml of a suspension of *Chaetoceros* sp. to each culture beaker once a week.

Calanus Species

Of the neritic-oceanic genus *Calanus*, representatives of the following species have been cultivated: *C. cristatus*, *C. finmarchicus*, *C. helgolandicus* and *C. hyperboreus*.

Calanus cristatus, a subarctic planktonic copepod, was collected in Pacific waters and maintained in filtered sea water at 8° C (OMORI, 1970). Positive correlations were observed between body length and quantity of food available during growth. When food became scarce, average wet weight decreased by approximately $\frac{1}{3}$ (dry weight $\frac{2}{3}$) of the maximum weight. Carbon contents ranged from 50 to 59% of the dry weight, nitrogen varied from 8 to 11%. Dry-weight carbon was highest in the adult female and lowest in the adult male. Food scarcity affects sex ratio similarly as in *C. hyperboreus* (food scarcity favours the appearance of males; CONOVER, 1965). Conceivably, certain environmental factors may govern the sex ratio in such a way that a large number of males is present only in situations in

which they are needed. In the sea, large diatoms (*Coscinodiscus asterompharus*, *C. lineatus* and *Denticula seminae*) constituted the major portion of the recognizable stomach contents in summer.

Calanus finmarchicus has attracted concerted attention. Among the pioneers who first attempted to cultivate this abundant pelagic copepod were ALLEN and NELSON (1910) and CRAWSHAY (1913). BOND (1937b) presented a brief note. MARSHALL and ORR authored numerous papers on *C. finmarchicus* and published a classic compilation (1955) on its biology. CORKETT (1967, 1970) reviewed laboratory techniques employed for breeding.

ALLEN and NELSON (1910) placed a few *Calanus finmarchicus* in a flask which contained 1000 cm³ unsterilized sea water and to which had been added 0.5 cm³ of Miquel's solution B*, and 0.5 cm³ of a 1.5% solution of anhydrous sodium carbonate, and a quantity of a culture containing representatives of several diatom species. *C. finmarchicus* survived for several weeks, and two nauplii developed into young copepods.

MARSHALL and ORR (1952) kept *Calanus finmarchicus* females singly in crystallizing dishes with 20 ml ultra-filtered sea water ('Gradocol'-filter membrane of 0.9- μ m pore diameter) and changed the culture water every second day. At about 16° C, *C. finmarchicus* survived for up to several months. Maximum total egg production per female was 586 eggs. Egg laying may be spread over as long as 74 days and tends to occur in a series of bursts, each burst lasting for a week. Females of the overwintering stock lay their eggs early in the morning, mainly between midnight and 3 a.m.; females of the first generation, which attain maturity in May, lay eggs throughout 24 hrs. A single sperm transfer suffices for the whole egg-laying period. Egg production depends on the food available. Starved females cease oviposition; if fed again, they continue to lay eggs, eventually not much less than specimens fed continuously (Table 5-39). With the exception of *Coscinodiscus centralis*, all the diatoms tested as food organisms, as well as some of the flagellates, gave good results. *Chlorella stigmatophora* and *Hemiselmis rufescens* were unsuitable. *Calanus finmarchicus* kept in natural sea water produced only small numbers of eggs unless the water was rich in diatoms. MARSHALL and ORR's data supersede some of the information presented in older reports by FULLER (1937) and RAYMONT and GROSS (1942).

Calanus helgolandicus has been used for food-uptake experiments by RICHMAN and ROGERS (1969). This copepod filters the diatom *Ditylum brightwellii* at a constant rate of 50 ml per copepod day⁻¹. Apparently, *C. helgolandicus* searches selectively for paired cells (before separation after cell division) of the diatom *Ditylum brightwellii* and passively filters single cells. Filtering rates were studied in a feeding tube assembly (Fig. 2-151, p. 238) at 15° C and calculated separately for copepods grazing on paired and single daughter cells. The volume of paired cells filtered was 1.5 times that of the singles. In diatom concentrations consisting of 0 to 24% pairs, *C. helgolandicus* filtered at a constant rate of 50 ml per individual day⁻¹. Above 40% pairs, filtering attained a maximum of about 170 ml per individual

* Miquel prepared this solution in the 1890's for cultivating diatoms. Information on his techniques and on the constituents of solutions A and B can be found in the paper by ALLEN and NELSON (1910, p. 423).

day⁻¹. Between 20 and 40% pairs, the filtering rate increased proportionally to the percentage of pairs, and ingestion of paired cells increased exponentially in relation to their concentration.

In *Calanus helgolandicus* rate of carbon ingestion has been determined by MULLIN and BROOKS (1970a; Fig. 5-43), who cultivated this copepod under conditions similar to those used for *Rhincalanus nasutus* (p. 783). However, nauplii of

Table 5-39

Calanus finmarchicus. Effect of nutrition on egg production. Average number of eggs produced 2 to 7 days after beginning of experiment. Crystallizing dishes with ultra-filtered sea water; about 16° C (After MARSHALL and ORR, 1952; modified; reproduced by permission of Marine Biological Association of the U.K.)

Nutrition	Total no. of females	No. of females laying eggs	Total no. of eggs	Eggs batch ⁻¹	Eggs female ⁻¹ day ⁻¹
<i>Chlamydomonas</i> sp.	11	9	401	20.4	9.1
Starved	8	3	30	12.5	0.9
<i>Chlamydomonas</i> sp.	20	18	839	21.4	8.8
Starved	20	6	64	12.4	0.8
<i>Chlamydomonas</i> sp.	15	14	1183	23.0	15.4
<i>Coscinodiscus centralis</i>	15	13	261	11.5	3.0
<i>Skeletonema costatum</i>	15	14	787	19.5	9.4
Starved	15	9	84	8.9	1.0
<i>Chlamydomonas</i> sp.	15	14	1146	29.0	16.4
<i>Peridinium trochoideum</i>	15	15	865	24.8	11.5
<i>Rhizosolenia delicatula</i>	15	12	463	22.6	6.6
Starved	8	5	81	15.4	2.3
<i>Chlamydomonas</i> sp.	15	15	1566	30.5	17.4
<i>Dicrateria inornata</i>	15	11	200	16.8	2.5
<i>Chlorella stigmatophora</i>	15	7	71	15.3	0.8
Starved	8	6	105	19.8	2.2
<i>Chlamydomonas</i> sp.	15	15	1139	26.6	12.8
<i>Hemiselmis rufescens</i>	13	10	133	14.5	1.7
<i>Syracosphaera carterae</i>	15	15	1016	28.9	11.8
<i>Ditylum brightwellii</i>	15	15	1422	24.2	16.7
Starved	8	2	34	28.0	0.8
<i>Chlamydomonas</i> sp.	13	13	1549	32.1	20.7
<i>Lauderia borealis</i>	15	15	1779	33.4	21.2
<i>Gymnodinium</i> sp.	15	15	1974	29.9	21.9
Starved	11	7	182	16.2	2.8

C. helgolandicus were found to be unable to grow on *Ditylum brightwellii*, and while the culture conditions did not affect sex ratio in *R. nasutus*, they markedly altered the quantitative relationship between males and females in *C. helgolandicus*. At food concentrations greater than 150 $\mu\text{g C l}^{-1}$, the amount of food required to reach a particular developmental stage is independent of temperature (within the range offered) and hence constant, regardless of the period necessary to reach that stage. At lower food concentrations, the copepods reach a particular stage at a

lower weight; since growth efficiency remains high, apparently less food is required to obtain that stage. MULLIN and BROOKS conclude that, as the food concentration decreases (within the range tested), the increased metabolic cost of capturing a certain amount of food is possibly balanced by an increased efficiency of food conversion. Increase in conversion efficiency as a consequence of food scarcity is known to occur in a variety of invertebrates and fishes (Volume II: PANDIAN, 1975). The amount of food available to juvenile *C. helgolandicus* appears to affect their fecundity if mature. A female growing up at low food concentrations will be both lighter and shorter than her well-fed sisters and may produce fewer eggs than a larger female (MULLIN and BROOKS, 1970a, c; see also PAFFENHÖFER, 1970).

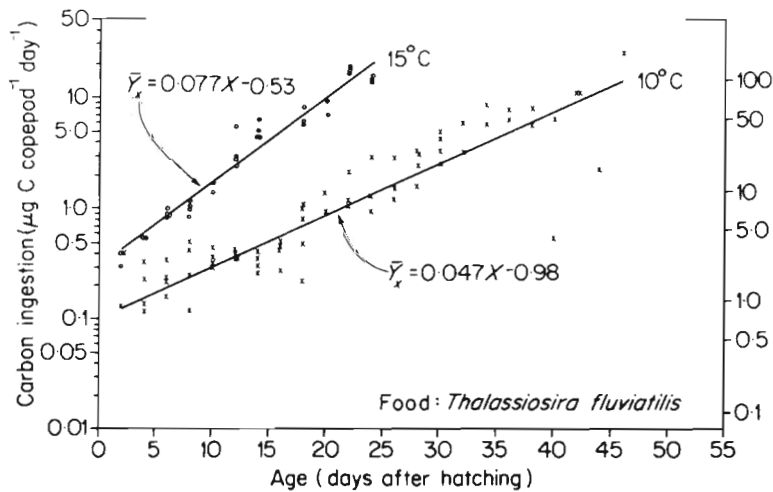

Fig. 5-43: *Calanus helgolandicus*. Rate of carbon ingestion as a function of age. For details consult legend to Fig. 5-49. (After MULLIN and BROOKS, 1970a; modified; reproduced by permission of University of California Press.)

The carbon content (a measure of size) of *Calanus helgolandicus* depends on the concentration of food available during rearing (MULLIN and BROOKS, 1970b); such a relationship has also been established on the basis of body-length measurements for *C. helgolandicus* by PAFFENHÖFER (1970) and for *C. cristatus* by OMORI (1970). Further information on the relationship between food density and weight of *C. helgolandicus* as well as on cumulative ingestion and growth rate has been presented by MULLIN and BROOKS (1970c). Employing previously described culture techniques (MULLIN and BROOKS, 1970a, b), the diatom *Thalassiosira fluviatilis* and the dinoflagellate *Gymnodinium splendens* were used as food sources and offered to cultures maintained at 12° and 17° C, respectively. Experiments were designed so that 'high', 'medium' and 'low' food concentrations were tested in replicate for each of the 2 food organisms at both temperatures. The time required for nauplii to attain the median C IV stage increases with decreasing food concentrations, especially at densities below 200 µg C l⁻¹ (Table 5-40). During the

Table 5-40
Calanus helgolandicus. Time required to develop from nauplius to median CIV stage as a function of food concentration. \bar{x} : mean, w : range. (After MULLIN and BROOKS, 1970c; modified; reproduced by permission of Limnology and Oceanography)

Food: <i>Thalassiosira weissfathii</i>			Food: <i>Gymnodinium splendens</i>		
Food concentration (cells ml ⁻¹)	Age of median CIV (days)	Temperature: 12° C	Food concentration (cells ml ⁻¹)	Age of median CIV (days)	Temperature: 17° C
\bar{x} = 4750 (w = 3840-7000)	18	\bar{x} = 75	\bar{x} = 271 (w = 46-420)	18	\bar{x} = 188 (w = 122-332)
\bar{x} = 4590 (w = 2420-6240)	20	\bar{x} = 87 (w = 382-983)	\bar{x} = 318 (w = 174-534)	18	\bar{x} = 188 (w = 124-325)
\bar{x} = 1300 (w = 720-2200)	19	\bar{x} = 21 (w = 5-34)	\bar{x} = 78 (w = 17-125)	19	\bar{x} = 55 (w = 41-73)
\bar{x} = 1040 (w = 623-1630)	20	\bar{x} = 15 (w = 4-44)	\bar{x} = 54 (w = 15-160)	22	\bar{x} = 58 (w = 47-66)
\bar{x} = 400 (w = 200-634)	23	\bar{x} = 6 (w = 1-13)	\bar{x} = 23 (w = 5-46)	30	\bar{x} = 25 (w = 6-50)
\bar{x} = 312 (w = 100-634)	23	\bar{x} = 5 (w = 2-14)	\bar{x} = 19 (w = 6-49)	23	\bar{x} = 24 (w = 6-50)
\bar{x} = 4700 (w = 4050-5960)	14	\bar{x} = 51 (w = 33-90)	\bar{x} = 188 (w = 122-332)	16	\bar{x} = 188 (w = 124-325)
\bar{x} = 3840 (w = 2070-5630)	14	\bar{x} = 51 (w = 34-88)	\bar{x} = 188 (w = 124-325)	16	\bar{x} = 55 (w = 41-73)
\bar{x} = 1380 (w = 624-2060)	16	\bar{x} = 15 (w = 11-20)	\bar{x} = 55 (w = 41-73)	18	\bar{x} = 58 (w = 47-66)
\bar{x} = 1220 (w = 845-1970)	14	\bar{x} = 16 (w = 13-18)	\bar{x} = 58 (w = 47-66)	18	\bar{x} = 25 (w = 6-50)
\bar{x} = 423 (w = 345-624)	16	\bar{x} = 7 (w = 2-14)	\bar{x} = 25 (w = 6-50)	24	\bar{x} = 24 (w = 6-50)

same developmental phase, the total amount of food taken up decreases with decreasing food concentration below $300 \mu\text{g C l}^{-1}$. The dry weights of C IV individuals are directly correlated with the food concentration available during growth and are not significantly affected by the two experimental temperature levels. Gross growth efficiency is inversely related to the total amount of food taken up during development. Apparently, *C. helgolandicus* can grow with high efficiency at natural food concentrations.

PAFFENHÖFER (1970) reared *Calanus helgolandicus* from egg to adult in tilted, slowly rotating jars (planktonrotor, Fig. 2-145, p. 233) of 3000 ml (nauplii), 4000 ml (nauplii and copepodites I), or 8000 ml (copepodites II to adults) capacity. Fertilized females were collected 3 to 5 km off La Jolla (USA) and kept at 15°C in 1000-ml beakers containing filtered sea water and fed diatoms *Lauderia borealis* (see also CONOVER, 1970). Freshly laid eggs were transferred to separate beakers and nauplii introduced to the planktonrotor. Nauplii and all subsequent developmental stages received chain-forming diatoms as food (*Chaetoceros curvisetus*, *Skeletonema costatum*, *Lauderia borealis*) as well as the dinoflagellate *Gymnodinium splendens*. Population densities of food algae paralleled those in the natural habitat ($28 \mu\text{g}$ to $800 \mu\text{g organic C l}^{-1}$). Depending on quality and quantity of food, mortality (nauplius to adult) ranged from 2.3% to 58.2%; time span between hatching and adulthood, from 18 to 54 days; female size, from 3.03 to 3.84 mm. A laboratory-raised and fertilized female produced an average of 1991 eggs, of which 84% hatched. PAFFENHÖFER's results indicate that natural variations in food density may significantly affect mortality, growth, size and sex ratio.

Using freshly tow-netted adult females and Stage V individuals of *Calanus helgolandicus*, CORNER and co-authors (1972) determined rates of grazing on the diatom *Biddulphia sinensis* kept in suspension. At copepod concentrations of 6 individuals in 1350 ml of sea water, and at a food concentration of 11,300 diatom cells l^{-1} , the rations removed are estimated to reach a maximum of 1800 cells copepod $^{-1}$ day $^{-1}$. The maximum value found for the volume of sea water swept clear was unusually high: 700 ml individual $^{-1}$ day $^{-1}$. For details on transformation of organic matter, consult Volume IV: CONOVER (in press).

Calanus hyperboreus, collected in slope water of the Gulf of Maine (USA), were maintained in membrane-filtered sea water containing either penicillin or streptomycin (50 mg l^{-1}) and suitable food organisms (usually the diatom *Thalassiosira fluviatilis*) in a concentration of 5 to 10×10^6 cells l^{-1} (CONOVER, 1967; see also CONOVER, 1962, 1966a, b). Culture water was changed at least once a week. For studies on oviposition and naupliar development, females were isolated in 200-ml culture water (pint-size, polyethylene freezer containers) at 5°C . To prevent cannibalism, the female was separated from her eggs by a screen (\neq 000 nylon bolting cloth) suspended several millimetres above the bottom of the culture container; she was removed after oviposition. As young stages of *C. hyperboreus* are very sensitive to handling, culture water was added rather than the nauplius transferred. A female deposits up to 388 eggs simultaneously. One normally fed female produced on average 1340 eggs of which 58% hatched. A starving female produced 450 eggs. At 4° to 6°C , egg development lasts 66 hrs. Once breeding has started, the presence or absence of food seems to have little effect on the fecundity of *C. hyperboreus*. The

reproductive behaviour observed under laboratory conditions appears to be consistent with what is known on breeding in the sea.

Euchaeta japonica

Early developmental stages (from 3rd nauplius on) of *Euchaeta japonica* have been raised by LEWIS (1967) in an enrichment solution similar to the 'ES' medium developed by PROVASOLI (unpublished) for culturing phytoplankton and seaweeds (Table 5-41). The enrichment solution is diluted to 2% with membrane-filtered (0.45 μm) sea water. Food (*Isochrysis galbana*, *Phaeodactylum tricornutum*, *Dunaliella* sp.) was added during the late second nauplius stage in 1:2:1 ratio; total food

Table 5-41

Euchaeta japonica. Enrichment solution used for raising early developmental stages. The solution is diluted to 2% with membrane-filtered sea water (Based on PROVASOLI, unpublished; after LEWIS, 1967; reproduced by permission of American Society of Limnology and Oceanography)

Components	Amount	Components	Amount
Distilled water	100 ml	P-II metal mix	
NaNO ₃	350 mg	(for 100 ml of mix use):	
Na ₂ glycerophosphate	50 mg	H ₃ BO ₃	0.114 g
P-II metals (see right column)	25 ml	FeCl ₃ ·6H ₂ O	4.9 mg
Vitamin B ₁₂	10 μg	MnSO ₄ ·4H ₂ O	16.4 mg
Thiamine	0.5 mg	ZnSO ₄ ·7H ₂ O	2.2 mg
Biotin	5 μg	CoSO ₄ ·7H ₂ O	0.48 mg
Niacin	888 μg	Na ₂ EDTA	100 mg
DL pantothenol	888 μg		
Choline chloride	1 mg		
Riboflavin	444 μg		
Ascorbic acid	1 mg		
Pyridoxine HCl	888 μg		
Tris buffer	500 mg		

concentration was approximately 2000 cells cm^{-3} . The naupliar stages of *E. japonica* are herbivorous, but from the first copepodite stage on, this copepod is carnivorous. Organic solutes seem beneficial for developing stages. Survival rates from egg through sixth nauplius were about 65% in fed cultures.

Eurytemora Species

Coastal-water living representatives of the copepod genus *Eurytemora* have been cultured by HEINLE (1969b) in artificial sea water and by KATONA (1970, 1971) in sterilized natural sea water.

HEINLE (1969b) kept *Eurytemora affinis* populations for 15 months in 'Instant Ocean' and 'Rila Marine Mix' (with 25 mg sodium bicarbonate added l^{-1}), but rates of reproduction remained poor. HEINLE used the same culture technique as for

Acartia tonsa (p. 768); he suspects nutrient deficiency or toxicity as main causes for the limited success obtained.

Representatives of the euryhaline *Eurytemora affinis* and *E. elongatus* were isolated by KATONA (1970) from a plankton haul. Washed several times in sterile sea water, the copepods were placed in 1-l jars. Stock cultures were started and sustained as described for *Pseudocalanus elongatus* by KATONA and MOODIE (1969; p. 781). As the experimental populations increased in size, larger culture containers were provided and bacteria-free *Isochrysis galbana*, *Cyclotella nana*, *Platymonas* sp. and *Skeletonema costatum* used as food (mixed diets). Stock cultures of *E. affinis* and *E. herdmani* were sustained over numerous generations at 15° C and

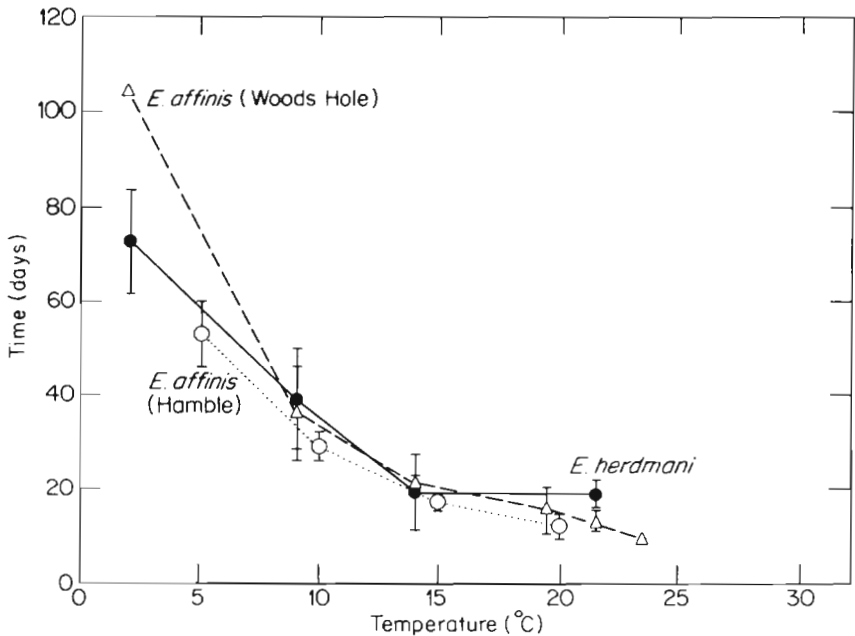

Fig. 5-44: *Eurytemora affinis* and *E. herdmani*. Generation times (± 2 standard deviations) in 20‰ salinity as a function of cultivation temperature. (After KATONA, 1970; modified; reproduced by permission of Biologische Anstalt Helgoland.)

20‰S (in constant light to promote growth of food algae). HEINLE and FLEMER (1975) postulate that natural populations of *E. affinis* consume detritus to meet part of their energy requirements.

Generation times for *Eurytemora affinis* and for *E. herdmani* vary with temperature (Fig. 5-44). At 2° C, *E. herdmani* develop faster and more successfully than *E. affinis* from Woods Hole (no experiments were performed at 2° C on *E. affinis* from the Hamble River). Above 18° C, *E. herdmani* does not reproduce, even though some adults mature; generation time at 21.5° C was estimated from mature adults. Failure to reproduce and failure of generation time to decrease further suggest that at 21.5° C *E. herdmani* is under thermal stress. Generation times of *E. affinis* range from 105 days at 2° C to 9 days at 23.5° C; for *E. herdmani* from 73 days at 2° C to 19 days at 15° C. Body lengths of cultivated *E. affinis* were within

ranges recorded for wild counterparts; however, cultivated *E. herdmani* remained smaller than wild specimens. Both species attained larger body lengths at 2° C than at 21.5° C (with the exception of *E. herdmani* females). Low developmental temperatures increased the proportion of female *E. affinis* and increased the percentage of male *E. herdmani*. This finding requires qualification. Environmentally induced variations in sex ratio of copepods have been suggested or proved in several cases (TAKEDA, 1950; EGAMI, 1951; BATTAGLIA, 1959a, b; MEDNIKOV, 1961; CONOVER, 1965; HEINLE, 1969a). More detailed experimental analyses are desirable.

The life span of females of *Eurytemora affinis* and *E. herdmani* extends over 100 days at 2° C; it decreases with increasing temperatures. Females of both species produce fertile eggs long after mating. This fact suggests the possibility that females mate in autumn, overwinter, and produce offspring without further mating in spring. Higher rates of development and reproduction of *E. herdmani* at low temperatures are in accordance with the more northerly geographic distribution of this species; the ability of *E. affinis* to reproduce at temperatures approaching 25° C correlates with its distribution as far south as the Gulf of Mexico (KATONA, 1970). Developmental stages of laboratory-cultured *E. affinis* have been described and discussed by KATONA (1971); those of *E. americana* and *E. herdmani* by GRICE (1971).

Euterpina acutifrons

The coastal planktonic copepod *Euterpina acutifrons* has been cultivated by BERNARD (1963), NEUNES and PONGOLINI (1965), NASSOGNE (1970) and HAQ (1972). *E. acutifrons* is widely distributed between latitudes 66° N and 40° S. It breeds at sea temperatures between 8° and 30° C.

NEUNES and PONGOLINI (1965) kept *Euterpina acutifrons* individually ('single cultures') in 30-ml Boveri dishes or in groups of more than 10 specimens ('mass cultures') in Erlenmeyer flasks (2 to 10 l) filled to half their capacity or less. To counteract bacterial growth, 6.5 mg l⁻¹ penicillin were added. It seemed important to NEUNES and PONGOLINI to maintain low, but continuously effective, levels of antibiotics during the initial period in which the copepods are weakened due to handling and transportation (the penicillin was found to exert a bacteriostatic effect for less than 1 day). *E. acutifrons* received a mixed diet consisting of the flagellates *Tetraselmis micropapillata*, *Dicrateria* sp. and *Platymonas* sp., a dino-flagellate *Gymnodinium* sp. and the diatom *Phaeodactylum tricornerutum*. The culture medium was changed at regular intervals (1 week to 1 month), using a siphon fitted with nylon gauze to prevent losses. EDTA (37 mg l⁻¹) was added as complexing agent to the natural sea-water medium. The population remained in the same culture container for 1 year. The mass of live and dead algae and of the detritus accumulating at the bottom was never removed and did not seem to affect the copepods. Young naupliar stages always dominated, suggesting high rates of larval mortality. Generally, population density was between 1000 and 3000 copepods l⁻¹, with rather marked fluctuations. At 18° C, development from egg to adult took 17 to 18 days (Table 5-42), and generation time averaged 20 to 21 days. In contrast, *E. acutifrons* cultivated by HAQ (1972) at 18° C had a generation time of only 15 to 16 days.

so that the whole sac is rectangular. Within a few minutes, all eggs swell into spheres, and the sac assumes its characteristic oval shape. Eggs which failed to enter the sac at the time of laying soon decompose. Rate of development (Fig. 5-48a) increases uniformly between 10° and 20° C. Generation time at 10° C is about 53 days; at 25° C, about 9 days. Maturation time of females (period between moult yielding the adult and first oviposition) at various temperatures is shown in Fig. 5-48b, duration of postembryonic stages in Fig. 5-48c. The longest maturation period is 8 days at 10° C; the shortest 1 to 1.5 days at 25° C. Egg production is poor at this high temperature; maximum egg production occurs at 20° C. Larvae survive best between 16° and 20° C. Observations in field and laboratory indicate

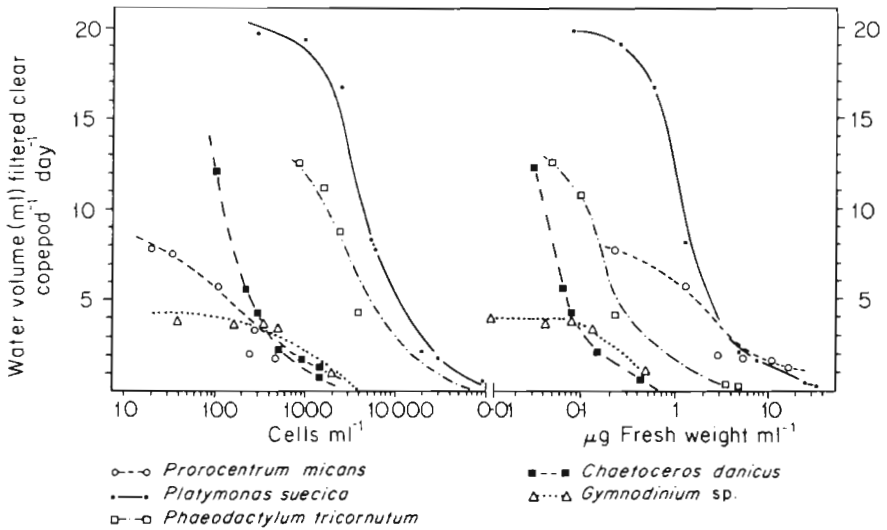

Fig. 5-46: *Euterpina acutifrons*. Filtration rates of adult females decrease with increasing food concentration (number of cells or weight of larvae ml^{-1}), and depend on the species of algae offered. Photoperiod: 12 hrs light; 18° C. (After NASSOGNE, 1970; modified; reproduced by permission of Biologische Anstalt Helgoland.)

that, under favourable environmental conditions, the production of small males (these develop faster than large males and are sexually more potent, always copulating readily) increases. The small male is a breeding form associated with actively reproducing populations.

Metridia Species

In the two planktonic copepods *Metridia lucens* and *M. longa*, HAQ (1967) studied rates of respiration, feeding and assimilation. Freshly caught specimens were sorted and offered *Thalassiosira nordenskiöldii* as first food source (5° C). The filtration rates recorded were inversely related to food concentration, but the slope of the curves obtained varied with the food organism offered. With small-sized food (5 μm), filtration rate was generally lower than with large-sized food

(300 μm). Food ingestion increased with food concentration up to a certain level, beyond which it declined. Both copepods prefer animal food (nauplii of *Artemia salina*) to phytoplankton when given a choice. HAQ found the filtration rates measured to be insufficient to meet respiratory expenditures at particulate-carbon concentrations prevailing in the natural habitat, except for *Artemia salina* nauplii. However, HAQ's culture enclosures were probably too small (38 ml); the use of such small containers results in subnormal feeding rates (CUSHING, 1958). Presumably, jars of 5 to 20 l would have led to higher, more normal, filtration rates. Dietary requirements were met more easily from a mixed diet than from a single-species diet. *M. lucens* must be considered to be an effective predator on small zooplankton.

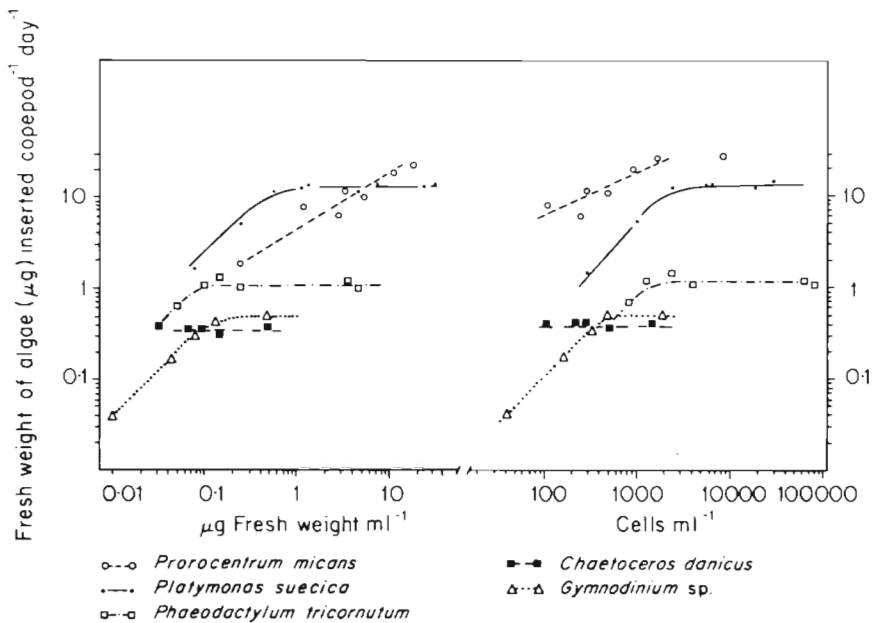

Fig. 5-47: *Euterpina acutifrons*. Ingestion rates of adult females. Photoperiod: 12 hrs light; 18° C. (After NASSOGNE, 1970; modified; reproduced by permission of Biologische Anstalt Helgoland.)

Pseudocalanus Species

Pseudocalanus elongatus has been bred over 6 months (approximately 4 generations) by KATONA and MOODIE (1969) in a 4-l glass jar on a mixed diet of *Isochrysis galbana*, *Platymonas* sp. and, occasionally, *Skeletonema costatum*. All cultures were kept in constant fluorescent light 'of moderate intensity' at 25° C. An abundant bacterial flora developed in the culture containers (no antibiotics were used) in addition to ciliate protozoans which may have served as supplementary food source. Algal food was added so that the culture water always had a green tinge and cell concentration remained around 100,000 ml^{-1} or higher. Every 2 weeks, the culture water was poured through 35- μm mesh plankton netting, mounted on a Perspex cylinder, and the copepods resuspended in fresh filtered sea water with

The influence of food quantity and quality on egg production, rates of filtration and ingestion, and on population growth of *Euterpina acutifrons* was examined by NASSOGNE (1970; see also 1969). *Platymonas suecica*, *Dicrateria* sp., *Platymonas* sp., *Gymnodinium* sp. and *Phaeodactylum tricornerutum* served as food sources. The sea water used was filtered and autoclaved at 120° C and 0.5 atm; it contained 0.1 mg l⁻¹ of penicillin and 37 mg l⁻¹ of EDTA. Mass cultures were kept in 20-l Erlenmeyer flasks filled with 10 l of food solution. Permanent air bubbling was supplied and the temperature maintained at 18° C (weak illumination, photoperiod: 12 hrs light). NASSOGNE changed the culture medium at intervals ranging

Table 5-42

Euterpina acutifrons. Duration of larval stages, determined in 'single cultures'. 18° C. *n*: number of individuals tested (After NEUNES and PONGOLINI, 1965; modified; reproduced by permission of Macmillan [Journals] Ltd.)

Larval stage	<i>n</i>	Duration (days)
Nauplius	I	1.3 + 0.5*
	II	1.4
	III	1.3
	IV	1.5
	V	1.5
	VI	1.0
Copepodite	I	1.6
	II	1.7
	III	1.9
	IV	1.6
	V	2.2
		Total: 17.5 days

* To the mean duration of naupliar Stage I, 0.5 days were added, because at time 0 the nauplii were between 0 and 24 hrs old.

from 1 week to 1 month. For techniques employed to study ingestion of food, filtration rate and egg production by *E. acutifrons*, consult NASSOGNE (1969). High population growth was possible in food mixtures of 15 or 16 different algae species and in food solutions containing *Platymonas suecica*, *Phaeodactylum tricornerutum* (Fig. 5-45) and *Chaetoceros danicus*. Productivity was high in the presence of food algae between 6 and 16 μ m in size; larger algae such as *Prorocentrum micans* and *Gymnodinium* sp. cannot, apparently, be ingested by one or more of the copepod's developmental stages; smaller algae such as *Coccolithus huxleyi* cannot be filtered efficiently. Experiments with *E. acutifrons* females, fed different concentrations of *P. suecica*, revealed that (i) the number of algal cells ingested increases until a plateau is reached at 5. 10³ cells ml⁻¹; (ii) egg production attains maximum values at 10⁵ cells ml⁻¹ (at low food concentrations, only very few eggs are produced).

Filtration rates decrease with increasing algal concentration; at the same concentration, they differ as a function of the food-algae species (Figs 5-46 and 5-47).

HAQ (1972) collected dark-coloured mature females of *Euterpina acutifrons* from wild plankton and kept them at different temperatures. Following oviposition, each female was transferred to a Boveri dish containing 10 to 15 ml of sea water maintained at 10°, 14°, 18°, 20° or 25° C. Newly hatched nauplii were transferred

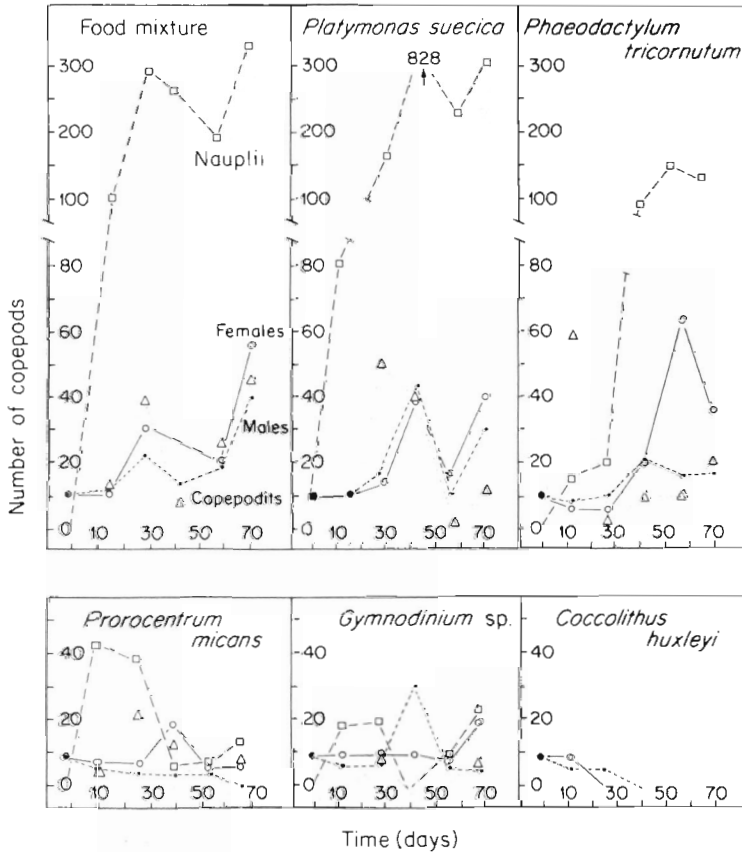

Fig. 5-45: *Euterpina acutifrons*. Population growth as a function of food. Weak illumination, photoperiod: 12 hrs light 18° C. Food mixture: algae of 16 different species. (After NASSOGNE, 1970; modified; reproduced by permission of Biologische Anstalt Helgoland.)

with a fine, smooth-ended pipette to a culture dish containing 150 ml of sea water. The larvae received cultured *Phaeodactylum tricornerutum*. The amount of food provided never exceeded a level at which a thin layer of diatom cells could be seen on the dish bottom (excessive food resulted in high copepod mortality). The medium remained unchanged and undisturbed except for occasional stirring.

Egg laying in *Euterpina acutifrons* is similar to that described for *Calanus finmarchicus* (RAYMONT and GROSS, 1942); however, the eggs (3 to 38) are surrounded by an egg sac; freshly fertilized eggs are flattened, and arranged in 4 rows,

new food. According to KATONA and MOODIE, slow passage of culture water through the fine mesh minimizes damage to the copepods; a more gentle method is siphoning through an inverted glass funnel leading into vinyl tubing and onto the plankton netting. Experiments in small vessels failed since the nauplii tended to become trapped on the water surface.

KATONA and MOODIE (1969) attribute their success to the mixed diet provided, the relatively large volume of the culture container, and to minimizing handling of

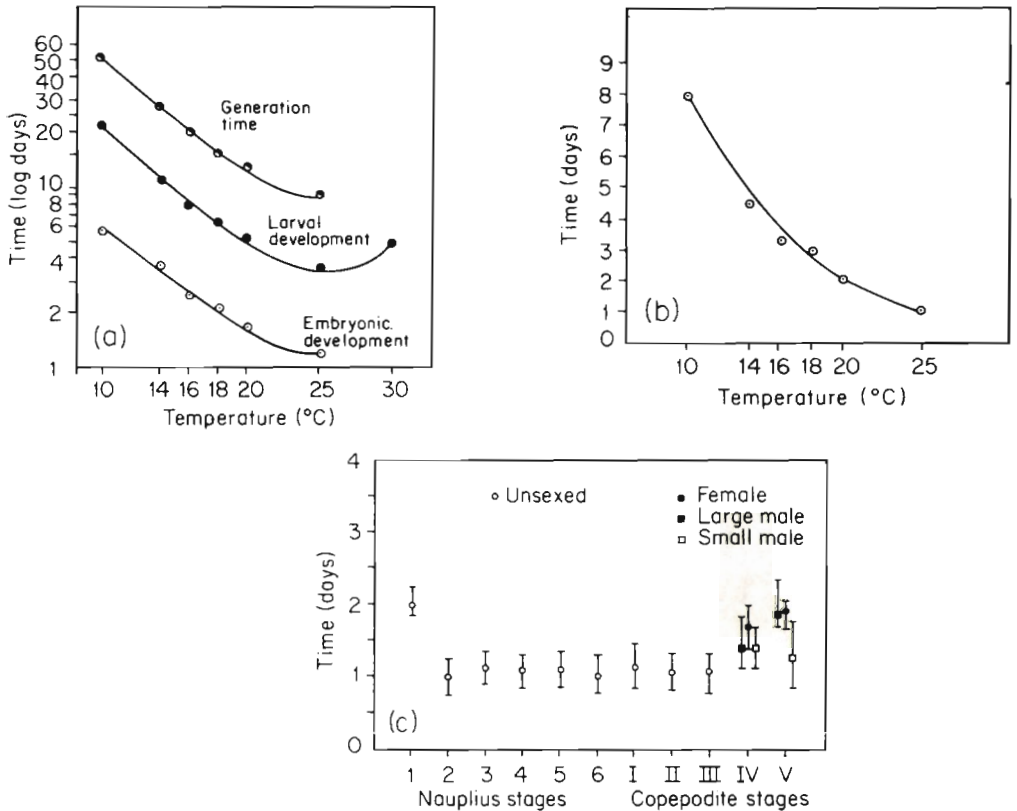

Fig. 5-48: *Euterpina acutifrons*. (a) Rate of embryonic and larval development, and generation time; (b) average maturation time (attainment of adulthood to first oviposition); (c) duration of post-embryonic stages at 16°C. (After HLAQ, 1972; modified; reproduced by permission of Springer-Verlag.)

the copepods. In addition, the large number of mature adults used to start the culture may have increased the chances of success. The relatively high temperature applied tends to shorten the life span, to decrease the final size attained, and to limit the number of eggs laid. Hence, maximum rates of reproduction have probably not been attained. *Pseudocalanus elongatus* is more stenoplastic and more difficult to cultivate than *Eurytemora affinis* and *E. herdmani* (p. 776). Additional, if less informative, culture experiments on *P. elongatus* have been conducted by CORKETT and URRY (1968) and CORKETT and McLAREN (1969).

Pseudocalanus minutus was reared under continuous weak illumination at 12° C from egg to adult by CORKETT (1967; see also CORKETT and MCLAREN, 1970). Stage-I nauplii were raised to copepodid I at 0°, 3°, 7° or 12° C. CORKETT stresses the importance of 3 points: (i) use of fresh sea water taken from the same sea area as the adults; (ii) maintenance of a high food concentration (*Isochrysis galbana*); (iii) minimum disturbance of copepods (no changing of sea water during experiments).

LOCK and MCLAREN (1970) raised Stage III copepodites of *Pseudocalanus minutus* to maturity in the presence of excess food (200,000 cells ml⁻¹ of Erd-schreiber-cultured *Isochrysis galbana*) at 5°, 8° and 12° C. The cultures were weakly illuminated during the 12 hrs at 8° C. Individuals were placed in vials containing 20 ml of culture water; groups of 17 to 20, in bottles with 400 ml. The culture water consisted of membrane-filtered sea water with 37 mg l⁻¹ of EDTA. Half of the water was changed every 3 or 4 days. Mean length of adult females was inversely related to experimental temperature, but length of males remained unaffected. Mean length of females reared in a light-temperature regime simulating natural conditions did not differ significantly from estimated mean length at a constant intermediate temperature. A possible adaptive value of vertical migration (MCLAREN, 1963: copepods feeding in warm surface water and resting in cold deeper water should gain size and fecundity advantages over individuals living at a temperature equivalent to the mean temperature experienced by migrants) is not supported by LOCK and MCLAREN's experiments. Unfortunately, the food concentrations offered considerably exceeded *in situ* conditions. Responses at natural food densities and feeding schedules remain to be examined.

Grazing rates in freshly caught *Pseudocalanus minutus* on natural particles suggest that food uptake is strongly correlated with particle concentration except in the size range below 3.57 µm (POULET, 1974). Maxima were recorded in 10 to 57 µm particles. Maximum food consumption occurred in early spring, when large-sized particles were consumed. During summer and part of autumn, medium and small-sized particles were fed on. Food uptake was rarely less than 2.26% of body weight during winter, and could reach up to 55% or more in spring. Acquisition of organic matter by copepods receives detailed attention in Volume IV: CONOVER (in press).

Rhincalanus nasutus

Rhincalanus nasutus is the first oceanic copepod that has been cultivated successfully through several generations. This breakthrough has been achieved by MULLIN and BROOKS (1967). Collected off La Jolla (USA) at 12° C (seasonal average for subsurface waters at the sampling site), *R. nasutus* has been accommodated in glass carboys containing 19 l of membrane-filtered sea water to which a mixture of food, equivalent to 1 to 5 mg of particulate organic carbon per litre, had been added. The food consisted of the diatoms *Cyclotella nana*, *Thalassiosira fluviatilis*, *Ditylum brightwellii*, occasionally *Coscinodiscus wailesii*—all grown in uni-algal culture—and nauplii of *Artemia salina* (for older copepodite stages). Initially, 50 mg l⁻¹ of streptomycin sulphate or penicillin 'G' (1625 units mg⁻¹) were added. However, this antibiotic treatment was later discontinued since it did not improve survival. The water in the carboys was stirred continuously (2 rpm) by a large lucite propeller suspended on a lucite shaft near the bottom of the carboy, and air was

introduced through a glass tube (trickle of bubbles). Most of the culture water was very slowly siphoned out of each carboy through a filter screen which retained the copepods plus any eggs in the last litre of water. Copepods and eggs were removed with a pipette, examined under a dissecting microscope to determine their developmental stage, and then pipetted into new, filtered sea water containing a fresh mixture of food in the rinsed carboy.

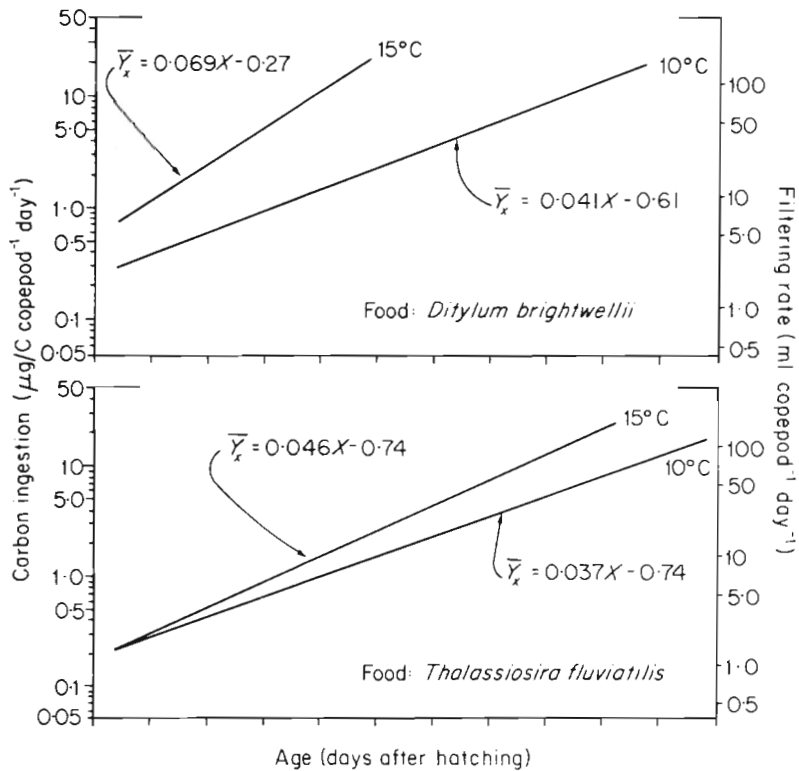

Fig. 5-49: *Rhinocalanus nasutus*. Rate of carbon ingestion as a function of age (six experiments). $\bar{Y}_x = \log_{10} (\mu\text{g C ingested copepod}^{-1} \text{ day}^{-1})$; $x = \text{age in days}$. Right ordinate: equivalent filtering rate at a food concentration equal to $150 \mu\text{g C l}^{-1}$. (After MULLIN and BROOKS, 1970a; modified; reproduced by permission of University of California Press.)

Under these conditions, MULLIN and BROOKS (1967) kept up to 100 adults or several hundred nauplii of *Rhinocalanus nasutus* (about 100 times the population density found in the natural habitat). Gravid females captured in the sea with plankton nets survived well and produced eggs for several weeks. The mean generation time of *R. nasutus* was similar to that of the local field population during the same season: 8.7 weeks. However, fecundity was lower in laboratory-reared individuals. Instantaneous coefficients of individual exponential growth (k in the equation

$$W_t = W_0 e^{kt}$$

where W = body weight in organic carbon and t = days) were 0.24 to 0.12 day⁻¹, depending on age. Even young nauplii of *R. nasutus* preferred large food particles. About 10 µg of detrital carbon were produced as exuviae during the growth of an individual.

Rhincalanus nasutus grows more rapidly on *Ditylum brightwellii* than on *Thalassiosira fluviatilis* (Fig. 5-49), apparently because the nauplii accept *D. brightwellii* more readily than *T. fluviatilis* (MULLIN and BROOKS, 1970a). Rates of ingestion per unit body carbon decrease as body carbon increases; growth rates usually decrease with increasing age. Gross growth efficiency over the juvenile life is 30 to 45%. Surprisingly, this efficiency did not decrease with increasing age, and was not affected by the temperatures offered. *R. nasutus* grows more slowly at 10° C than at 15° C, but does not necessarily grow to a larger size. Respiratory rates of laboratory-raised specimens are similar to those of their wild counterparts.

Other Species

RAYMONT and MILLER (1962) kept mixed populations of *Acartia tonsa*, *Eurytemora hirundoides*, *Paracalanus crassirostris* and *Oithona brevicornis* in two concrete tanks of 20 m³ capacity, each filled with sea water of 35‰S, coarsely filtered and fertilized by addition of potassium phosphate and sodium nitrate (reduced natural daylight; 18.0° to 23.6° C). Weekly samplings revealed rich and varied phytoplankton (diatoms, coccolithophorids, dinoflagellates and nannoplankton flagellates) with a tendency for *Exuviaella* sp., *Nannochloris* sp. or *Nitzschia* sp. to dominate. For the latter half of this multispecies culture experiment, *A. tonsa* dominated with only occasional, short-lived bursts of *P. crassirostris* and *O. brevicornis*. The total number of copepods ranged between 100 and 600 l⁻¹. The results indicate that abundant food allows high population densities of copepods, but that unknown factors tend to limit variety and, later, also individual numbers.

Copepods of the Black Sea have been maintained in culture by GARBER (1939), KLYUCHAREV (1948) and CHAYANOVA (1950). CHAYANOVA described methods of rearing *Acartia clausi*, *Centropages kroyeri* and *Calanus helgolandicus*. She stresses the need for (i) frequent water change; (ii) constant or slowly changing temperatures; (iii) fresh phyto- and zooplankton food. SAZHINA (1968a) cultivated 10 species of Black Sea Calanoidea and Cyclopoidea in glass cylinders of different volume allowing 30 to 50 ml of irradiated (quartz lamp PRK-4) sea water for each individual. Eggs and young naupliar stages were kept in glass dishes of 15 to 20 or 150 to 200 ml capacity. BRANDL (1973) reared carnivorous cyclopoid copepods on a mixed diet consisting of unicellular green algae and large-sized protozoans.

Employing practically identical methods as for *Euterpina acutifrons* (p. 777), NASSOGNE (1970) also conducted culture experiments on *Centropages typicus*, *Clausocalanus acuticornis* and *Ctenocalanus vanus*. OMORI (1973) reports on *Calanus cristatus* and related species. Culture methods comparable to those used for *Calanus helgolandicus* (PAFFENHÖFER, 1970, 1971) have allowed egg-to-adult cultivation of *Centropages furcatus*, *Eucalanus elongatus*, *Paracalanus parvus* and *Temora turbinata* (PAFFENHÖFER, personal communication). KASAHARA and co-authors (1975) have hatched 'resting' eggs of the neritic *Tortanus forcipatus* (optimum temperature: ca 25° C). Copepod resting eggs have also received attention from SAZHINA (1968b),

ZILLIOUX and GONZALEZ (1972), KASAHARA and co-authors (1974) and from GRICE and GIBSON (1975). As in other organisms, the resting eggs facilitate survival under adverse environmental conditions.

Information regarding the culture of *Oithona nana* has been provided by MURPHY (1923); *Pseudodiaptomus coronatus*, by JACOBS (1961); *Centropages hamatus*, by MULLIN and BROOKS (1967); *Acartia clausi* and *Idya furcata*, by CORKETT (1968); see also RAYMONT and GROSS (1942), URRY (1965) and McLAREN (1963).

Copepoda as Assay and Food Organisms

While it is easier to mass culture benthic forms, planktonic copepods tend to respond more sensitively to environmental changes and often are excellent water-body indicators. Since several marine planktonic copepods can now be cultivated,

Table 5-43

Planktonic copepods considered suitable as food source for cultured fish larvae (After KITAJIMA, 1973; modified; reproduced by permission of the Plankton Society of Japan)

Species	Source
<i>Acartia clausi</i>	Fo, K, N
<i>Oithona brevicornis</i>	Fo
<i>O. nana</i>	K
<i>Sinocalanus tenellus</i>	Fo, N
<i>Pseudodiaptomus inopinus</i>	N

Fo: Fisheries Experimental Station, Fukuoka Prefecture, 1973.

K: Fisheries Experimental Station, Kumamoto Prefecture, 1973.

N: Aquaculture Research Institute, Nagasaki Prefecture, 1973.

their usefulness as assay organisms should be thoroughly explored. Copper and mercury poisoning have been investigated in *Nitocra spinipes* (BARNES and STANBURY, 1948) and in *Acartia clausi* (CORNER and SPARROW, 1956).

Copepods are of great importance as food for other cultivated animals, especially fishes. Current pertinent research concentrates on selecting species which are most useful as food and which can be mass cultured conveniently.

Among the benthic copepods, several species of *Tigriopus* and *Tisbe* have been mass cultured. They are euryplastic and thrive on a large variety of diets. The cultures can be harvested continuously and at relatively high yields. In Japan, *Tigriopus japonicus* is considered the most promising food-organism candidate (KITAJIMA, 1973; see also IWASAKI, 1973). Adult benthic copepods tend to stay close to the bottom or walls of the culture enclosure. This fact and their often rapid movements may make them largely unavailable, especially for free-water plankton feeders such as many fish larvae; however, the pelagic nauplius and copepodite stages—continuously produced by the surviving adults—provide suitable food.

Experiments conducted in Japan with the aim of selecting planktonic copepod species suitable as food for marine fish larvae have resulted in the list presented in Table 5-43. The brackish *Sinocalanus tenellus* and *Pseudodiaptomus inopinus* are, according to KITAJIMA (1973), difficult to acclimate to full strength sea water. This reduces their value as food organisms for marine fish larvae. The Japanese experiments were conducted in 0.5- to 1-ton plastic tanks. Tests using larger tanks are presently under way. The diets tested for mass culturing copepods used as food sources and their respective gross food values are listed in Table 5-44.

Table 5-44

Test diets offered to mass-cultured copepods and their respective food values.
 +: good, ±: medium, -: poor (After KITAJIMA, 1973; modified; reproduced
 by permission of the Plankton Society of Japan)

Species	Diet	Food value	Author or Source†
<i>Tigriopus japonicus</i>	Soy cake*	+	N
	Synthetic fish feeds	+	N
	Yeasts	+	N
	Diatom (<i>Nitzschia</i> sp.)	+	SATO and FUSHIMI
	Adhesive diatom	+	SATO and FUSHIMI
	Dried chicken droppings	+	SATO and FUSHIMI
	<i>Chlorella</i> sp.	-	N
	<i>Dunaliella</i> sp.	-	N
	Sea lettuce	-	SATO and FUSHIMI
<i>Acartia clausi</i>	Soy cake	±	N
	<i>Chlorella</i> sp.	-	N
	Synthetic food for yellow-tail	+	Fi
	Diatoms	-	N
<i>Sinocalanus tenellus</i>	Soy cake	±	N
	<i>Chlorella</i> sp.	-	N

* Soy cake is a by-product of soy-sauce fermentation.

† SATO and FUSHIMI: Fisheries Experimental Station, Hiroshima Prefecture.

Copepoda: Conclusions

In the study of biological productivity and trophic-level dynamics (Volume IV), progress depends acutely on increasing our present capabilities for copepod cultivation. We must know more about their environmental and nutritional requirements, as well as about their rates and efficiencies of growth and reproduction. Successful copepod mass cultures can provide excellent assay organisms and food for a large variety of cultured zooplankton feeders.

Essential aspects of culture methods employed for benthic and planktonic marine copepods have been summarized in Tables 5-45 and 5-46, respectively. As for other marine invertebrates, the most important considerations in copepod cultivation concern water quality and nutrition. While members of some species can be accommodated in cultures without difficulty (particularly benthic forms such as the euryplastic *Tigriopus* and *Tisbe* species), others exhibit more specific requirements and are often rather stenoplastic. Among the latter are especially oceanic

Table 5-45
 Summary of important culture methods developed for benthic copepods (Compiled from the sources indicated)

Species	Food	Duration	Remarks	Author
<i>Tigriopus brevicornis</i>	<i>Gyrosigma fasciola</i> , <i>Tetraselmis micropapillata</i>	3 generations	Easy to cultivate	GLAT (1967)
<i>T. brevicornis</i>	<i>Phaeodactylum tricorutum</i> : 50 to 100 cells mm^{-3}	Generation time at 18°C: 19.5 days	18°C; 11°C; fecundity: 5.1 to 7.7 eggs day^{-1} female ⁻¹	NEUNES and PONGOLINI (1965), COMITA and COMITA (1966)
<i>T. fulvus</i>	<i>Nitzschia closterium</i> and numerous other diets	Indefinite	Very euryplastic and tolerant of environmental stress	FRASER (1936)
<i>T. japonicus</i>	Large variety of diets; e.g. <i>Isochrysis</i> and <i>Rhodomonas</i> , bacteria and <i>Platymonas</i> , <i>Isochrysis</i> or <i>Chroocomonas</i> + vitamins or glutathione	Indefinite	Easy to cultivate	PROVASOLI and co-authors (1959)
<i>T. japonicus</i>	<i>Phaeodactylum tricorutum</i>	Indefinite	Easy to cultivate	COMITA and COMITA (1966)
<i>T. japonicus</i>	<i>Rhodomonas lens</i> + <i>Isochrysis galbana</i>	Indefinite	Bacteria-free cultures	SHIRAIISHI (1966)
<i>T. japonicus</i>	<i>Enteromorpha prolifera</i> , dried bonito, etc.	1-2 generations (?)	15° to 25° C	Ito (1970)
<i>T. japonicus</i>	<i>Chlorella</i> sp., beer yeast, pellet foods	3 generations	24° to 27° C; fecundity: 100 to 500 eggs female ⁻¹	KOGA (personal communication)
<i>T. japonicus</i>	<i>Cyclotella nana</i> + wheat flour + soya flour, etc.	3 generations	15°-27° C; fecundity: up to 500 eggs female ⁻¹	TAKANO (1971a)
<i>T. japonicus</i>	Mixtures of wheat and soya flour (1:1 by weight)	12 generations	15° to 27° C; glass aquaria	TAKANO (1971a)
<i>T. japonicus</i>	<i>Cyclotella nana</i> , <i>C. cryptica</i> , <i>Phaeodactylum tricorutum</i> , <i>Nitzschia closterium</i>	Indefinite; minimum generation time: 12 days	15° to 27° C; glass aquaria	TAKANO (1971a)

<i>T. japonicus</i>	Dry foods, such as starch, rice bran, fishmeal, trout pellets, 'WAKAMOTO', dried <i>Chlorella</i> sp.	Indefinite	—	HANAOKA (1973)
<i>Tisbe reticulata</i>	<i>Dunaliella</i> sp., <i>Phaeodactylum</i> sp., <i>Nitzschia</i> sp., <i>Ulva</i> sp., <i>Enteromorpha</i> sp., Zosteraceae, fish meat, wheat grains, mollusc flesh, etc.	Indefinite; generation time at 18° C: 10 to 15 days	Cup-shaped containers, 20 cm ³ of filtered sea water; easy to experiment with	BATTAGLIA (1959a, 1970)
<i>T. clodiensis</i>	Same as for <i>T. reticulata</i>	Indefinite	18° C; same culture methods as for <i>T. reticulata</i>	BATTAGLIA and FAVA (1968), BATTAGLIA and FINCO (1969), BATTAGLIA and VOLKMANN-ROCCO (1969), LAZZARETTO-COLOMERA and POLO (1969), VOLKMANN-ROCCO and FAVA (1969)
<i>T. furcata</i>	Dried kelp, fresh brown seaweed, dried mussel meat, etc.	3 generations	17° to 21° C; fecundity: 513 eggs female ⁻¹	JOHNSON and OLSON (1948)
<i>T. furcata</i>	Particulate matter	Indefinite	3° to 21° C; Griffin beakers containing 100 ml filtered sea water	BARR (1969)
<i>T. persimilis</i>	<i>Ulva</i> sp., <i>Dunaliella</i> sp., fragments of boiled wheat	Indefinite	18° C; 34‰S; same culture method as for <i>T. reticulata</i>	VOLKMANN-ROCCO and FAVA (1969)
<i>T. pori</i>	<i>Dunaliella tertiolecta</i> , <i>D. primolecta</i> , <i>Monochrysis lutheri</i> , <i>Apistonema</i> sp., <i>Phormidium</i> sp., <i>Phaeodactylum tricornutum</i> ; 3 × 10 ⁻⁴ packed cells ml ⁻¹	2-3 generations (?)	18° to 22° C; 250-ml Erlenmeyer flasks; continuous illumination	BETOUHIM-EL and KAHAN (1972)
<i>T. relictans</i>	<i>Ulva</i> sp., <i>Dunaliella</i> sp.	Indefinite; 3 generations. At 26° to 28° C: 7 days from hatching to maturity	18° C	VOLKMANN-ROCCO and FAVA (1969)

Table 5-46
 Summary of important culture methods developed for planktonic copepods (Compiled from sources indicated)

Species	Food	Duration	Remarks	Author
<i>Acartia clausi</i>	<i>Isochrysis galbana</i> , <i>Rhodomonas baltica</i> , <i>Euplores vannus</i> : 0.5 to 500 cells mm ⁻³	More than 1 year: 3 generations	15° C; artificial sea water. Recirculation system	ZILLIOUX (1969a, b)
<i>Acartia clausi</i>	<i>Asterionella japonica</i> : 3.5 to 56.3 cells mm ⁻³ ; <i>Ditylum brightwellii</i> : 0.8 to 88 cells mm ⁻³ ; <i>Duhalieella</i> sp.: 39 to 274 cells mm ⁻³ ; <i>Lauderia borealis</i> : 0.5 to 14.2 cells mm ⁻³ ; <i>Phaeodactylum tricornutum</i> : 10.5 to 903 cells mm ⁻³ ; <i>Skeletonema costatum</i> : 12.3 to 1032 cells mm ⁻³	Short-term feeding experiments	17° C; adult females only. Slowly rotating bottles	GAUDY (1971, 1974)
<i>Acartia clausi</i>	(See GAUDY, 1971, 1974)	Short-term feeding experiments	17° C; fecundity: 2 to 52 eggs female ⁻¹	GAUDY (1971)
<i>Acartia clausi</i>	<i>Gymnodinium</i> sp., <i>Platymonas suecica</i> , <i>Phaeodactylum tricornutum</i> , and other unicellular algae	6.5 months: 3 generations	18° C; filtered and sterilized sea water with antibiotics and EDTA (37 mg l ⁻¹); aeration. 20-l Erlenmeyer flasks	NASSOGNE (1970)
<i>A. tonsa</i>	<i>Chaetoceros</i> sp., <i>Chlamydomonas reinhardtii</i> , <i>Isochrysis galbana</i>	3 generations	16° to 26° C; artificial sea water; 12‰ S; continuous light. Erlenmeyer flasks of 0.5 or 2 l capacity	HEINLE (1969b, 1970)
<i>A. tonsa</i>	(See ZILLIOUX, 1969a)	—	14.5° C and lower; filtered natural or artificial sea water. Culture cylinders (30 mm diameter, 60 mm high)	ZILLIOUX and GONZALEZ (1972)

<i>A. tonsa</i>	<i>Isochrysis galbana</i> , <i>Rhodomonas</i> sp., and unidentified diatom: 10,000 to 38,000 cells ml ⁻¹	5 to 12 generations; mean generation time at 17° C: 25 days	Constant illumination 650 to 1300 lux. 17° C; Membrane-filtered sea water of 31‰ S; 1500-ml dishes	ZILLIOUX and WILSON (1964, 1966), ZILLIOUX (1968)
<i>A. tonsa</i>	<i>Isochrysis galbana</i> , <i>Rhodomonas baltica</i> , <i>Euploetes vannus</i> : ca 50,000 cells ml ⁻¹	More than 1 year; 3 generations	15° C; artificial sea water. Recirculation system	ZILLIOUX (1969a, b)
<i>Calanus finmarchicus</i>	<i>Thalassiosira fluviatilis</i> : 0.5 to 3.8 cells mm ⁻³	—	—	ANRAKU (1964b)
<i>Calanus finmarchicus</i>	<i>Nitzschia closterium</i> : 1.8 to 410 cells mm ⁻³	—	—	LEBOUR (1916), FULLER (1937)
<i>Calanus finmarchicus</i>	<i>Lauderia borealis</i> : 0.2 cells mm ⁻³ ; <i>Ditylum brightwellii</i> : 0.1 cells mm ⁻³ ; <i>Nitzschia closterium</i> : 155 cells mm ⁻³	—	—	HARVEY (1937)
<i>Calanus finmarchicus</i>	<i>Chlamydomonas</i> sp.: 5 to 45 mm ⁻³	Short-term grazing-rate measurements	10° C; sterilized sea water. 'Breffit' jars	GAULD (1951)
<i>Calanus finmarchicus</i>	<i>Lauderia borealis</i> , <i>Gymnodinium</i> sp., <i>Ditylum brightwellii</i> , <i>Chlamydomonas</i> sp., etc. (see Table 5-39) flagellates: 20 to 2400 cells mm ⁻³ ; diatoms: 0.01 to 800 cells mm ⁻³	Several months	16° C; crystallizing dishes with 20 ml ultra-filtered sea water; fecundity: 586 eggs female ⁻¹	MARSHALL and ORR (1952, 1955)
<i>Calanus finmarchicus</i>	Natural plankton and non-living particulate matter	Short-term ship-board studies	Food uptake studied on freshly collected material	ADAMS and STEELE (1966)
<i>C. helgolandicus</i>	<i>Cyclotella nana</i> , <i>Gymnodinium splendens</i> , <i>Thalassiosira fluviatilis</i> , <i>Artemia</i> nauplii, etc. (for concentrations, see Table 5-40)	3 generations	12° C (5°-17° C); membrane-filtered sea water; fecundity: 613 to 691 eggs female ⁻¹ . Glass carboys containing 19 l	MULLIN (1963), MULLIN and BROOKS (1970a, b, c)
<i>C. helgolandicus</i>	<i>Chaetoceros curvisetus</i> , <i>Gymnodinium splendens</i> , <i>Lauderia borealis</i> , <i>Skeletonema costatum</i> : 28 to 800 µg C l ⁻¹	Several months: 2 generations	15° C; filtered sea water. 1000-ml plankton rotor	PAFFENHÖFER (1970, 1971)

Table 5-46—Continued

Species	Food	Duration	Remarks	Author
<i>C. helgolandicus</i>	<i>Dunaliella</i> sp.: 2.3 to 110 cells mm ⁻³ ; <i>Lauderia borealis</i> : 0.07 to 12.3 cells mm ⁻³ ; <i>Phaeodactylum tricornutum</i> : 21 to 1022 cells mm ⁻³ ; <i>Skeletonema costatum</i> : 15 to 1033 cells mm ⁻³	Short-term feeding experiments	17° C (?); adult females only. Slowly rotating bottles	GAUDY (1974)
<i>C. helgolandicus</i>	Natural particulate matter	Short-term experiments	—	CORNER (1961)
<i>C. hyperboreus</i>	<i>Thalassiosira fluviatilis</i> : 5 to 10 × 10 ⁶ cells l ⁻¹	Several months	5° C; membrane-filtered sea water with antibiotics; fecundity: 1340 eggs female ⁻¹ ; hatching rate: 58%	CONOVER (1962, 1966a, 1967)
<i>C. hyperboreus</i>	<i>Cyclotella nana</i> , <i>Ditylum brightwellii</i> , <i>Rhizosolenia setigera</i> , <i>Striatella unipunctata</i> , <i>Thalassiosira fluviatilis</i> , etc.: various cell densities	Several months	5 to 6° C; 12° C; darkness. Rotating jars	MULLIN (1963)
<i>C. cristatus</i>	Stomach contents of freshly collected summer individuals: <i>Coscinodiscus asterompharus</i> , <i>Coscinodiscus lineatus</i> , <i>Denticula seminiae</i>	Short-term experiments	8° C; filtered sea water	OMORI (1970)
<i>Centropages typicus</i>	<i>Asterionella japonica</i> : 1.5 to 120 cells mm ⁻³ ; <i>Dunaliella</i> sp.: 31 to 320 cells mm ⁻³ ; <i>Lauderia borealis</i> : 0.1 to 23 cells mm ⁻³ ; <i>Skeletonema costatum</i> : 72 to 950 cells mm ⁻³	Short-term experiments	17° C; adult females only; Slowly rotating bottles; fecundity: 7 to 113 eggs female ⁻¹	GAUDY (1971, 1974)
<i>Euchaeta japonica</i>	<i>Dunaliella</i> sp., <i>Isochrysis galbana</i> , <i>Phaeodactylum tricornutum</i> : 2000 cells cm ⁻³	Several weeks	'Enrichment solution' (see Table 5-41); survival from egg through 6th nauplius: ca 65%	LEWIS (1967)

<i>Euterpina acutifrons</i>	<i>Chaetoceros danicus</i> , <i>Dicrateria</i> sp., <i>Phaeodactylum tricornutum</i> , <i>Platymonas suecica</i> , etc.: 0.3 to 80 cells mm ⁻³	Several months	Weak illumination, 12-hr day; 18° C; 20-l Erlenmeyer flasks; aerated sea water with antibiotics and EDTA (37 mg l ⁻¹)	NASSOGNE (1970)
<i>Euterpina acutifrons</i>	<i>Phaeodactylum tricornutum</i>	Several months; generation time at 18° C: 15 to 16 days	10° to 25° C; 10 to 15-ml Boveri dishes; fecundity: ca 100 eggs female ⁻¹	HAQ (1972)
<i>Euterpina acutifrons</i>	<i>Dicrateria</i> sp., <i>Gymnodinium</i> sp., <i>Platymonas suecica</i> , <i>Phaeodactylum tricornutum</i> , etc. (see Figs 5-45, 5-46, 5-47)	Several months	Weak illumination, 12-hr day; 18° C; autoclaved; filtered sea water, antibiotics	NASSOGNE (1970)
<i>Euterpina acutifrons</i>	<i>Dicrateria</i> sp., <i>Platymonas</i> sp., <i>Gymnodinium</i> sp., <i>Phaeodactylum tricornutum</i> , <i>Tetraselmis micropapillata</i>	18 months; generation time at 18° C: 17 to 18 days	18° C; 30-ml Boveri dishes; 2- to 10-l Erlenmeyer flasks; antibiotics; fecundity: 100 to 300 eggs female ⁻¹	NEUNES and PONGOLINI (1965)
<i>Eurytemora affinis</i> and <i>E. herdmani</i>	<i>Chaetoceros</i> sp., <i>Chlamydomonas reinhardtii</i> , <i>Isochrysis galbana</i>	12 months	12° to 26° C; 12‰S; limited success; nutrient deficiency (?)	HEINLE (1969b)
<i>Eurytemora affinis</i> and <i>E. herdmani</i>	<i>Isochrysis galbana</i> , <i>Cyclotella nana</i> , <i>Platymonas</i> sp., <i>Skeletonema costatum</i>	Numerous generations; generation time: see Fig. 5-44	Constant light; 15° C (2° to 21.5° C); 20‰S; sterilized natural sea water; 1-l jars, later larger containers	KATONA (1970)
<i>Metridia lucens</i> and <i>M. longa</i>	<i>Artemia salina</i> nauplii: 0.32 to 0.64 µg C l ⁻¹ ; <i>Dunaliella</i> sp.: 0.1 to 0.5 µg C l ⁻¹ ; <i>Thalassiosira nordenskiöldii</i> : 0.23 to 0.76 µg C l ⁻¹ ; both copepods prefer animal food to phytoplankton	Several months	5° C	HAQ (1967)
<i>Pseudocalanus elongatus</i>	<i>Isochrysis galbana</i> , <i>Lauderia borealis</i>	Several months	Darkness; 10° C; antibiotics	CORKETT and URRY (1968)

Table 5-46—Continued

Species	Food	Duration	Remarks	Author
<i>Pseudocalanus elongatus</i>	<i>Isochrysis galbana</i> , <i>Lauderia borealis</i>	Several months	6° to 7° C; fecundity: ca 100 eggs female ⁻¹	CORKETT and MCLAREN (1969)
<i>Pseudocalanus elongatus</i>	<i>Isochrysis galbana</i> , <i>Platymonas</i> sp., occasionally <i>Skeletonema costatum</i> : 100,000 cells ml ⁻¹	Several months	Constant fluorescent light at 'moderate intensity'; 15° C; 4-l glass jar	KATONA and MOODIE (1969)
<i>P. minutus</i>	<i>Isochrysis galbana</i> (high food concentration, e.g. 200,000 cells ml ⁻¹)	Several months	Weak illumination; 10° C (0° to 12° C); 20- or 400-ml containers; membrane-filtered sea water with EDTA (37 mg l ⁻¹); fecundity (6°-7° C): ca 180 eggs female ⁻¹	CORKETT (1967, 1970), CORKETT and MCLAREN (1969, 1970), LOCK and MCLAREN (1970)
<i>Temora longicornis</i>	<i>Chlamydomonas</i> sp.: 15 to 105 cells mm ⁻³	Short-term feeding experiments	—	GAULD (1951)
<i>T. stylifera</i>	<i>Asterionella japonica</i> : 22 to 101 cells mm ⁻³ ; <i>Dunaliella</i> sp.: 29 to 264 cells mm ⁻³ ; <i>Ditylum brightwellii</i> : 1 to 7 cells mm ⁻³ ; <i>Lauderia borealis</i> : 0.02 to 21 cells mm ⁻³ ; <i>Skeletonema costatum</i> : 32 to 1160 cells mm ⁻³	Short-term feeding experiments	17° C. Slowly rotating bottles	GAUDY (1971, 1974)
<i>Rhincalanus nasutus</i>	<i>Artemia salina</i> nauplii, <i>Cyclorella nana</i> , <i>Ditylum brightwellii</i> , <i>Thalassiosira flauitilis</i> ; occasionally <i>Coscinotiscus waiatesii</i> ; large food particles preferred; 1 to 5 µg C l ⁻¹	Mean generation time: 8.7 weeks	12° C (10° to 15° C); membrane-filtered sea water; fecundity: 'low'. Glass carboys containing 19 l	MULLIN and BROOKS (1967, 1970a)

forms such as *Rhincalanus nasutus*. None of the deep-sea copepods has been maintained in culture yet. Gut-content examination revealed that the bulk of food taken up by deep-sea copepods consists of heterotrophic micro-organisms (HARDING, 1974). Presumably, detrital remains of mesopelagic organisms contribute to the diet of deep-sea copepods.

For planktonic copepods, sea water is usually filtered and sterilized (autoclave, membrane filter) before use as culture medium. A few investigators have added antibiotics and chelating agents (EDTA). However, the usefulness and biological consequences of antibiotics remain to be explored more fully (see also p. 997). Culture containers were usually small (capacities of 1 to a few l), and were slowly rotated or aerated in order to produce some water movement and to facilitate gaseous exchange. The size of the culture enclosure, the water movement patterns and the distribution of food organisms may influence filtration rates, growth and development of the copepods cultivated (see also ANRAKU, 1964a).

The primary food items of most marine copepods are unicellular algae; a few feed also on animal matter. Although a variety of algae has been offered to cultured copepods, similarities in dietary requirements are more pronounced than are the differences. Algae which qualify as good diets for the planktonic copepods examined thus far are, for example, *Dunaliella* sp., *Isochrysis galbana*, *Phaeodactylum tricornerutum* and *Skeletonema costatum*; for further examples consult Tables 5-45 and 5-46. While uni-algal cultures could support good growth in several cases, mixed diets often gave better results. Axenic uni-algal cultures were usually less suited for meeting the copepods' nutritional requirements than were non-axenic uni-algal cultures. Possibly, the bacteria flora associated with non-axenically cultured algae can compensate to a certain degree for nutritional deficiencies of the alga itself.

The food value of the alga depends on a variety of properties, especially the following: (i) digestibility, i.e. cell-wall thickness, rigidity and resistance to digestive enzymes; (ii) chemical composition and calorific contents; (iii) size, shape, motility (catchability); (iv) taste, odour or toxicity; (v) algal cell concentration. To an appreciable extent, digestibility and chemical composition may depend on the environmental conditions under which the algae developed and on the conditions (e.g. temperature) prevailing during feeding and digestion.

Important points to be considered in the cultivation of stenoplastic copepods are:

(A) **Collection of material.** (i) Use non-toxic materials for collection and culture (Chapter 7). (ii) For first attempts at cultivation, collect the culture water from a sea area or water body in which the copepod concerned is known to establish large populations (proper water quality, possible conspecific conditioning). (iii) Employ careful means for copepod collection; injured individuals are poor culture material. (iv) Young life-cycle stages adjust more readily to culture conditions than older ones. It usually pays to collect egg-bearing females and to start a culture with their offspring, hatched under known laboratory conditions.

(B) **Water management and culture enclosure.** (i) Control light, temperature, salinity, oxygen, pH and organic waste-product levels (Chapter 2). The culture container must be sufficiently large (1 to several l capacity) and, at the same time, allow sufficient control and observation. (ii) Adjust water turn-over rate to population density and container size (frequent water exchange, recirculation or flow-through system). (iii) Avoid excessive handling and too much contact between

Table 5-47

Nutritional dynamics in the planktonic copepods *Calanus helgolandicus*, *Centropages typicus* and *Temora stylifera* offered different qualities and quantities of food (After GAUDY, 1974; reproduced by permission of Springer-Verlag)

Food alga*	Algal concentration (mg l ⁻¹)	Food intake (μg day ⁻¹)	Respiration (μl O ₂ day ⁻¹)	Equivalent organic matter (μg)	Egg production (No day ⁻¹) (μg)	Metabolic requirement (% food intake)	Gross efficiency†	Per cent assimilation
<i>Calanus helgolandicus</i>								
<i>L.b.</i>	0.27	8.4	9.13	12.25	0	15.4	0	—
	0.52	35	11	14.75	3.02	42.2	4.37	46.57
	0.52	39	14.65	19.65	9.10	49.2	11.90	61.10
	4.60	152	14.65	19.65	7.10	12.9	2.38	15.28
	4.60	180	15.60	20.90	16.70	11.6	4.70	16.30
	17.00	270	26.90	36.00	2	13.2	0.38	13.58
	17.00	295	24.70	33.20	7.01	11.2	1.21	12.41
	21.3	320	37.20	49.80	18.80	15.5	3.00	18.50
<i>S.c.</i>	1.21	11	18.3	24.50	0	222	0	—
	1.21	12	21.7	29.10	0	413	0	—
	1.55	15.2	20.9	28.00	0	184	0	—
	1.55	12.7	13.1	17.50	0	138	0	—
	1.55	15.2	18.3	24.50	0	162	0	—
	10.10	198	23.0	30.90	12.60	15.6	3.22	18.82
<i>P.t.</i>	0.33	10.3	13.8	18.55	4.50	180	22.20	—
	0.35	10.4	8.3	11.10	0	107	0	—
	24.10	92	21.10	28.30	17.2	30.7	9.50	40.20
<i>Centropages typicus</i>								
<i>S.c.</i>	1.68	2.17	5.02	6.73	2.60	310	11.95	—
	10.10	39.10	4.35	5.84	4.30	14.9	1.10	16.00
<i>P.t.</i>	1.22	1.01	3.83	5.13	2.18	508	21.80	—
	0.33	0.70	5.11	6.85	6.48	980	92.8	—
	0.33	0.81	4.71	6.33	2.68	780	33.40	—
	0.47	2.57	4.97	6.66	1.50	259	5.84	—
	0.47	2.12	5.15	6.90	4.80	325	13.20	—
	23.80	17.50	2.61	3.50	2.68	20	1.53	21.53

copepods and culture-vessel walls or other solid surfaces. (iv) Provide proper (slow) water movement and gaseous exchange (aeration).

(C) Nutrition. (i) Early ontogenetic copepod stages (nauplii) are herbivorous; later stages (copepodites, adults) may be omnivorous or carnivorous. Dietary requirements can usually be met better by mixed than by single-species foods. (ii) Proper food-particle size, concentration, distribution and digestibility require special attention. Proper food-particle distribution can best be controlled by adjustments in water movement and illumination. (iii) The food must be fresh, chemically uncontaminated and free of parasites or pathogenic micro-organisms. (iv) Avoid (reduce) addition of the food organisms' culture medium; use a sieve and wash retained food carefully before feeding.

Grazing rate, food intake, faecal-pellet production, egg laying and rates of respiration in several planktonic copepods have been studied by GAUDY (1974). His paper is of interest to the cultivator for optimizing food quantity and quality. GAUDY concludes that (i) grazing rate is high at low algal concentrations, decreases gradually as the food concentration rises, and finally ascends again until a plateau is reached. (ii) The daily food intake—fairly constant in the lower food-supply range—increases to a plateau as the food concentration increases. (iii) There is a significant correlation between daily food intake and faecal-pellet production. (iv) Copepods feeding on a multi-algal diet display food selectivity: they prefer large cells. (v) Respiration increases with food intake. The main results obtained by GAUDY are presented in Table 5-47.

In the copepods investigated, sex ratios deviating from 1:1 have been found both under field and laboratory conditions. The ecological significance of deviant sex ratios is unknown. Conceivably, they may mirror peculiarities in the reproductive biology of the species concerned and represent a regulatory mechanism for re-adjusting the reproductive potential under conditions of environmental change or stress (e.g. extreme temperatures, exploitation, competition, pollution). Maximum reproductive efficiency may be a function, among other things, of proper adjustments in sex ratio.

Although copepods, especially planktonic forms, qualify as excellent assay organisms, pertinent research remains to be done.

Criteria for selecting copepods suitable as food for cultured fishes and other organisms are rates of growth, reproduction, body size and calorific body contents of the copepods concerned (IKEDA, 1973). Most large-sized copepods live in the open sea and are more difficult to cultivate than the small-sized neritic or brackish copepods (especially harpacticoids). Proper selections must be made by compromising between the pros (fast growth and reproduction, large size and calorific value) and the cons (specific requirements, especially in regard to water quality, nutrition and culture management):

(c) Cirripedia

Adult cirripedes are the only sessile crustaceans (except some parasites). They attach to non-living solid substrata such as rocks, shells or concrete, as well as to organisms such as some plants, corals, fishes, turtles or whales. Evolutionary

development towards the sessile way of life has been accompanied by pronounced structural modifications and specializations for suspension feeding. Most Cirripedia inhabit marine or estuarine environments.

It is easier to cultivate warm-water cirripedes than cold-water forms, and success in barnacle cultivation has mostly been restricted to species whose larvae could be raised at moderately high temperatures, i.e. over relatively short periods of time. Early attempts to rear cirripedes from fertilized eggs or from naupliar stages obtained from plankton hauls have often failed. GROOM (1894) could not rear nauplii of *Balanus perforatus* beyond the second stage, and TREAT (1937) failed to rear *B. balanoides* beyond the third stage. Non-feeding nauplii of the goose-barnacle *Pollicipes spinosus* have been raised from egg to 'post-cypris', but no settlement occurred (BATHAM, 1945). The South African barnacles *B. algicola*, *B. amphitrite denticulata*, *B. maxillaris*, *B. trigonus*, *Chthamalus dentatus*, *Octomeris angulosa* and *Tetracrita serrata* could not be cultivated beyond the third naupliar stage (SANDISON, 1954). While BASSINDALE (1936) succeeded in rearing small numbers of larvae of *B. balanoides*, *C. stellatus* and *Verruca stroemia*, mortalities were high and the cyprides failed to settle. The major reason for the limited success of these and other early investigations seems to have been inadequate nutrition.

Rearing of Larvae

Although the culture methods presently employed for rearing cirripede larvae vary to some extent, essentials can well be exemplified by referring to the techniques used by COSTLOW and BOOKHOUT (1957a) and TIGHE-FORD and co-authors (1970).

COSTLOW and BOOKHOUT (1957a) scraped sexually mature *Balanus eburneus* from pilings and cleaned them of visible attached organisms. In the laboratory, the egg lamellae, which lie free in the mantle cavity, are isolated by removing the barnacle's base (or by breaking from the top). The developing eggs are then placed in finger bowls containing filtered sea water of 28.5‰S, with *Chlamydomonas* sp. as food, and penicillin (200,000 to 400,000 I.U. l⁻¹). The bowls are covered and maintained at 26° C (average habitat water temperature) under daylight fluorescent lamps. Hatched nauplii are transferred to a separate compartment of the rearing assembly. This assembly is made by drilling 100 holes in a piece of 0.95-cm lucite with a second solid piece of lucite forming the bottom. Each well thus formed has a capacity of 1.2 cm³. The further procedure may be summarized as follows: (i) Place the assembly in a glass dish, cover, and maintain in a temperature-controlled culture cabinet. (ii) Check wells once or twice a day with a binocular dissecting microscope. (iii) After the second moult, add freshly fertilized *Arbacia punctulata* eggs daily as food source in addition to *Chlamydomonas* sp. (iv) Remove plutei developed from *A. punctulata* eggs of the previous day.

TIGHE-FORD and co-authors (1970) placed scraped-off adult *Elminius modestus* in a 5-l glass tank supplied with running sea water. Newly hatched larvae were reared in batches of 5000 to 10,000 in 4-l beakers, containing 1000 ml of diatom culture (*Skeletonema costatum*) at a concentration of approximately 2×10^6 cells ml⁻¹ and 2750 ml of unfiltered ultra-violet-sterilized sea water kept at ambient sea temperature. To each beaker, 0.4 ml of the antibiotic solution Crystamycin (300 mg sodium penicillin G plus 0.5 g streptomycin sulphate base, in 2 ml distilled water)

was added. The larvae grow better in running than in stagnant sea water. To avoid high illuminance in the peripheral meniscus (which would cause the nauplii to aggregate, with the risk of being stranded on the side of the container), black tape should be attached to the outside of the beakers at the water line (see also WISELY, 1960). The beakers are placed in constant-temperature baths maintained at 20° C, with black sides. A 30-W fluorescent tube, installed 40 cm above the bath, ensures constant light conditions throughout rearing. The tops of the beakers are covered with a black polythene disc so that the larvae receive diffused light from the surrounding water in the bath. Further procedure: (i) Renew sea water and food 3 times a week. (ii) Pour culture contents through a 142- μ m-pore size nylon-mesh filter, which retains the larvae but passes the diatoms and most of the faeces. (iii) Wash empty culture enclosures with tap water. (iv) Add 1000 ml diatom culture and flush larvae back from the filter cup with sea water; add antibiotics; make up the total culture volume to 3750 ml. (v) For settlement, expose ground glass slides (11 × 4 × 0.2 cm) for 2 or 3 days to flowing sea water in order to allow a bacterial film to develop. (vi) To promote settling on the slides, agitate the water with a stirrer paddle rotating at 25 revs min⁻¹.

A modification of the method employed by TIGHE-FORD and co-authors (1970) has been described by WALKER (1973), who reared larvae of *Balanus hameri*, *B. balanoides* and *Elminius modestus*. WALKER and his colleagues used plastic bins containing 60 l of filtered sea water. To each bin they added 5 l (= 350 mg dry weight) of cultured *Skeletonema costatum* as food source and antibiotics (1.8 g penicillin plus 3.0 g streptomycin). The cultures were kept in the dark and agitated by bubbling with filtered air. Sea water and food were renewed twice a week. At 10° C, *B. hameri* settled after 28 days. Stage I nauplii of *B. balanoides* and *E. modestus* were obtained by crushing adult barnacles carrying ripe eggs in sea water. Newly hatched nauplii could easily be collected after attracting them towards a light source. They were cultured at 20° C as outlined above. *E. modestus* larvae reached the settling stage (cypris) after 7 to 9 days.

MOYSE (1960) developed mass-rearing methods for barnacle cyprides. He reared the nauplius larvae in stagnant sea water contained in a series of 1-l Pyrex beakers. Before use, the sea water was pasteurized and Erdschreiber nutrients were added at half strength to support the growth of algal food. No antibiotics were added. MOYSE kept his cultures at about 20° ± 3° C on a laboratory bench where they received daylight from a north-facing window.

Food for Larvae

For adequate nutrition of cirripede larvae, the specific nutritional needs in terms of quality (food algae) and quantity (food concentration) must be explored. The food value for cirripede larvae of various flagellates and diatoms has been assessed by MOYSE (1963) and MOYSE and KNIGHT-JONES (1967). The results obtained are summarized in Fig. 5-50. Larvae of the Arctic-boreal *Balanus balanoides* require diatoms for food, whereas those of the lusitanian and tropical species *Chthamalus stellatus*, *Lepas anatifera* and *L. pectinata* need flagellates. In general, the nutritional requirements of *C. stellatus* larvae are similar to those of oceanic barnacles.

The main food-catching organ of cirripede larvae is the antenna (MOYSE and KNIGHT-JONES, 1967). It bears delicate plumose setae and setules, which form a close-meshed filtering area in the basal region of the endopodites. The fine food particles collected are scraped by the setae of the mandible endopodites and pushed into the mouth by the gnathobases and neighbouring structures, during subsequent strokes of antennae and mandibles. In the later naupliar stages, locomotion is hindered by long processes trailing posteriorly and bearing numerous

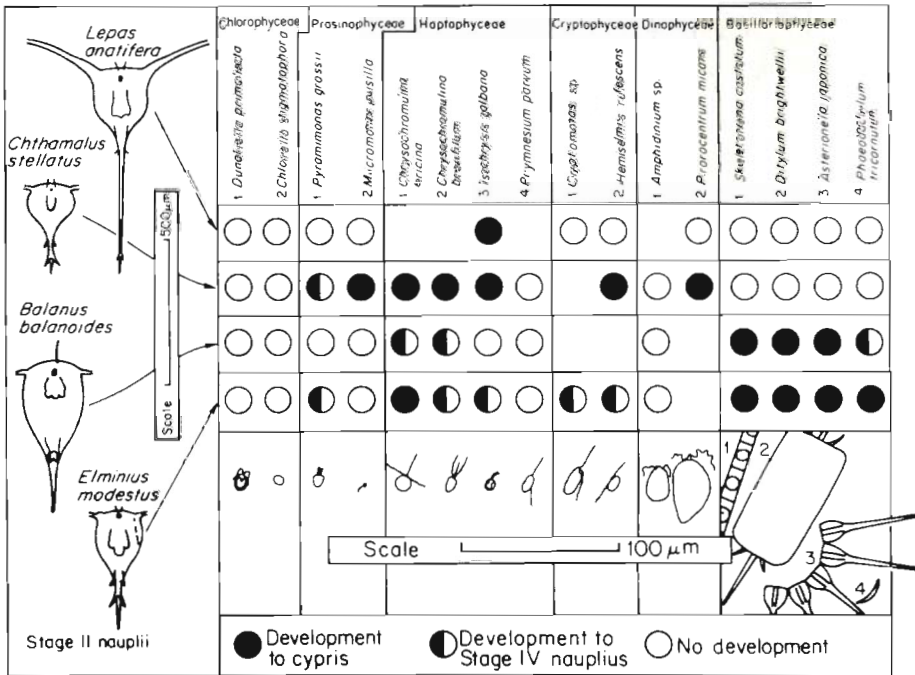

Fig. 5-50: Food value to cirripede larvae of different unicellular algae. The larvae are shown at the stage at which they begin to feed. *Lepas anatifera* and *Chthamalus stellatus* complete their development on flagellates, but *Balanus balanoides* requires diatoms. The algae are drawn to a scale about 5 times that of the barnacle larvae. (After MOYSE and KNIGHT-JONES, 1967; reproduced by permission of Biological Association of India.)

spines. The processes increase the volume of water filtered during each limb stroke. In a Stage IV nauplius of *Lepas anatifera*, for example, the caudal spine is about 9 mm long while the body itself measures only about 1.5 mm in length. Filtering *L. anatifera* larvae can retain particles as small as 5 μm.

According to KARANDE and THOMAS (1971), *Dunaliella primolecta* supports good larval development of *Balanus amphitrite communis* and *Chthamalus* species kept under laboratory conditions. Orientation in settling barnacle larvae, including aspects of feeding behaviour, have received attention from FORBES and co-authors (1971) and AYLING (1976).

Breeding

Mature individuals of the genus *Balanus*, kept isolated in separate containers, are incapable of self fertilization (DANIEL, 1958). However, when large numbers were maintained in the same culture enclosure, copulation and egg fertilization occurred.

Environmental requirements for breeding vary among cirripedes. Species, such as *Balanus amphitrite*, *B. perforatus* and *Chthamalus stellatus*, for example, breed only over a small range of temperature; others, such as *Elminius modestus* breed over a wide range of temperature (PATEL and CRISP, 1960a). While these species produce several broods per breeding season, *Balanus balanoides* and *B. balanus* each produce only one brood annually.

In *Balanus balanoides*, temperatures above 10° C suppress breeding (BARNES, 1957, 1959; CRISP, 1957; CRISP and CLEGG, 1960), and a 'conditioning period' at temperatures below 10° C may be essential immediately prior to breeding (see below). BARNES, H. (1963) suggests that such thermal conditioning is particularly associated with the later stages of oogenesis and, perhaps, spermatogenesis. At both high and low temperatures, constant illumination of 'moderate' intensity (fluorescent light) suppresses gonad development of female and male (BARNES, 1963), oviducal gland-sac formation (TIGHE-FORD, 1967), and penis development (BARNES and STONE, 1972). The inhibition can be removed after transfer to darkness. Whether the secondary sexual characteristics (oviducal gland, penis) are directly affected by light and temperature or indirectly via gonadal activities remains to be investigated.

As in most other animals, ovarian development in *Balanus balanoides* is dependent upon adequate nutrition. Starvation causes a regression of ovarian tissue (BARNES and BARNES, 1967). However, even after starvation periods as long as 5 months, feeding results in renewed ovary development. The maximum period between resumption of feeding and the time of laying down egg masses was 169 days.

Under laboratory conditions (dishes of stagnant sea water; ambient daylight at a north-facing window; food source: larvae of *Artemia salina*), the cirripedes *Balanus balanoides*, *B. balanus* and *B. crenatus* require maintenance for several weeks below a critical temperature before the breeding condition can be attained (CRISP and PATEL, 1969). The critical temperatures lie between 10° and 12° C for *B. balanoides*, 10° and 14° C for *B. balanus*, and near 17° C for *B. crenatus*. In the sea, all three species breed mainly or exclusively in winter. The strong influence of continuous light and the weak influence of continued feeding in delaying the onset of breeding in *B. balanoides* were confirmed; however, there remained some unexplained anomalies between the breeding behaviour under laboratory conditions and in the sea. It was not possible to initiate breeding in *B. balanoides* by conditioning procedures significantly in advance of the time of normal autumn breeding. A similar, largely endogenous control of breeding appears to prevail in *B. balanus* (breeds once annually in the sea), but not in *B. crenatus* (breeds continually in the sea as long as food and temperature permit) (see also CRISP, 1954, 1959a, b; CRISP and DAVIES, 1955; CRISP and CLEGG, 1960; PATEL and CRISP, 1960b; TIGHE-FORD, 1967; BARNES and BARNES, 1954; BARNES, H., 1963).

PATEL and CRISP (1960a) and CRISP and PATEL (1969) induced breeding in

several warm-water cirripedes including *Balanus perforatus*, *B. amphitrite denticulata*, *Chthamalus stellatus* and *Elminius modestus*. The cirripedes were induced to breed by slowly raising the temperature and by offering liberal amounts of larvae of *Artemia salina* as food source. Well-nourished individuals of *B. perforatus* and *C. stellatus* commenced to breed after being kept for 2 to 3 weeks at 15° to 16° C; *B. amphitrite denticulata* required a temperature of 17° to 18° C, *E. modestus* of 8° to 9° C. The percentage of barnacles bearing embryos increased with temperature; maxima were reached in all 4 species between 22° and 25° C. The cirripedes continued to breed, though less efficiently, up to 28° or 30° C. Gonads matured only in fed individuals; those kept without food did not breed at any of the temperatures (but after being fed for 2 to 3 weeks bred readily).

Balanus Species

Mass cultures of *Balanus eburneus* larvae can be easily maintained in finger bowls or plastic compartment boxes (COSTLOW and BOOKHOUT, 1957a; p. 799). The larval phase of *B. eburneus* consists of 6 naupliar stages and 1 cypris stage. At 26° C, the first naupliar stage lasts 15 mins to 4 hrs; the second, 1 to 2 days (average 1 day); the third, 1 to 4 days (1.5 days); the fourth, 1 to 4 days (2 days); the fifth, 1 to 5 days (2.6 days); the sixth, 2 to 4 days (2.5 days). The cypris stage ranges from 1 to 14 days, but successful attachment occurs only in cyprides which settle 1 to 3 days following the final naupliar moult. The total larval development lasts from 7 to 13 days. Successful attachment and metamorphosis were observed in 16.3% of 121 barnacle cyprides examined.

Culture methods comparable to those outlined on p. 799 have been used for studying growth, moulting and development in the warm-water species *Balanus amphitrite*, *B. amphitrite niveus* and *B. improvisus* (COSTLOW and BOOKHOUT, 1953, 1956, 1957b, 1958a, b, c). *B. amphitrite denticulata* was cultured at 26° C and received *Chlamydomonas* sp. as well as fertilized eggs of *Arbacia punctulata* as food; *B. amphitrite niveus*, at 20° C, received *Chlamydomonas* sp.; *B. improvisus*, at 20° C, received *Chlamydomonas* sp. as well as *Nitzschia closterium* and *Chlorella* sp. According to COSTLOW and BOOKHOUT (1958a), *B. amphitrite denticulata* has 6 free-swimming naupliar stages and 1 cypris stage with the following durations: first stage, 10 mins to 6 hrs; second stage, 1 day; third stage, 1 to 3 days (average 1.5 days); fourth stage, 1 to 2 days (1 day); fifth stage, 1 to 3 days (1.5 days); sixth stage, 1 to 5 days (2.5 days). The cypris stage lasts from 1 to 8 days; successful settling and metamorphosis were observed only in cyprides which settled 1 to 3 days after the final naupliar moult. The time required for *B. amphitrite denticulata* to complete larval development is 7 to 10 days after hatching. Successful metamorphosis was observed in 12.7% of 126 cyprides studied. Mortality was highest during the sixth naupliar stage (22.2%) and the cypris stage (49.2%).

Rearing from egg to cypris was achieved in the warm-water forms *Balanus crenatus* by HERZ (1933), *B. amphitrite hawaiiensis* by HUDINAGA and KASAHARA (1941), *B. amphitrite*, *B. eburneus*, *B. improvisus* and *B. irigonus* by FREILBERGER and COLOGER (1966). The development and metamorphosis of *B. amphitrite variegatus* and *B. tintinnabulum tintinnabulum* have been investigated by DANIEL (1958).

Balanus variegatus, settled on bakelite panels immersed in a harbour in Bombay (India), were transferred by KARANDE (1974a) to small glass aquaria and the nauplii released were reared for studying subsequent growth stages. The rearing technique has been described by KARANDE and THOMAS (1971).

The biochemical composition of cultured cypris larvae of *Balanus balanoides* has been investigated by HOLLAND and WALKER (1975). At a mean total freeze-dried weight of 37.7 μg , a cyprid contains 12.4% ash, 9.2% neutral lipid, 8.2% total nitrogen, 6.8% protein nitrogen, 4.8% phospholipid, 3.2% chitin, 2.7% free sugars, and 0.8% polysaccharide. Free-swimming cyprides, prevented from settling for up to 8 weeks at 8° C, utilized their neutral lipid reserves; at the end of 8 weeks, 90% of the initial reserves were depleted. In contrast, phospholipids, free sugars and nitrogen decreased only slightly and the polysaccharide content remained comparatively constant.

The effects of food, light and of different, constant temperatures on the moulting frequency of *Balanus balanoides* have been studied by BARNES and STONE (1974). Over most of the year, the photoperiod does not affect moulting frequency, but tends to accelerate it during, and immediately after, reproductive anecydysis. Annual penis 'loss' and regeneration have been investigated by KLEPAL and BARNES (1974). Embryos of *B. balanoides*, *B. balanus*, *B. crenatus* and *B. perforatus* (as well as of *Chthamalus stellatus* and *Elminius modestus*) exhibit similar tolerances to variations in salinity: in all cases, development to the Stage I nauplius proceeded in the range 15 to 40‰S (BARNES and BARNES, 1974). There seems to be little direct correlation between salinity tolerance of embryos and habitat salinities.

Elminius modestus

After collecting nauplii released from adult *Elminius modestus* maintained in a glass tank receiving slowly-running sea water at 12° to 15° C, WISELY (1960) raised larvae right through to the settling stage. Strongly photopositive, the nauplii swim towards a light source placed at one end of the tank and can easily be pipetted off.

WISELY (1960) used the culture system illustrated in Fig. 5-51. In his system, unfiltered sea water enters the adult tank via a constant-level tube and leaves through an overflow. Part of the sea water is filtered (glass wool) in the lower third of the constant-level tube and enters the larva tank, passing a control screw clamp; it leaves through a sand filter (sa) supported by a glass-wool layer (gw) and a bed of small stones (st). From a non-bacteria-free *Phaeodactylum tricornerutum* culture which serves as food source for the larvae, a continuous flow passes a clamp and drips into the larval tank. The water in both adult and larval tanks is aerated. Dried liver powder is added to the larval tank as additional food source. Healthy larvae are extremely active and their alimentary canals are filled with *P. tricornerutum* (formerly *Nitzschia closterium* forma *minutissima*); sluggishness of the nauplii is often indicative of impending death. Excess amounts of liver powder and bacteria may tend to build up on the walls of the culture enclosure and may be detrimental. At 19° to 22° C, low but consistent yields (0.02 to 3.80%) of settling cyprides were obtained, the total from 5 consecutive experiments being 3431. These values are

considerably lower than the survival rates reported by other investigators. Most workers now use beakers.

In *Elminius modestus*, TIGHE-FORD and co-authors (1970) encountered high mortalities (up to 100%) at temperatures above 23° C (for methodological details see p. 799). At 20° C and 10° C, the time of the cypris stages was 11 to 17 and 21 to 34 days, respectively. This gives a Q_{10} value of about 2, which is in reasonable agreement with the rate of development in Stage I to Stage II *Balanus balanoides* (BARNES and BARNES, 1958). From 25 to 50% of the original larval population survived settlement. Young barnacles have been kept alive for over 15 weeks and attained diameters of 6 to 8 mm. Over this period, barnacle survival has been

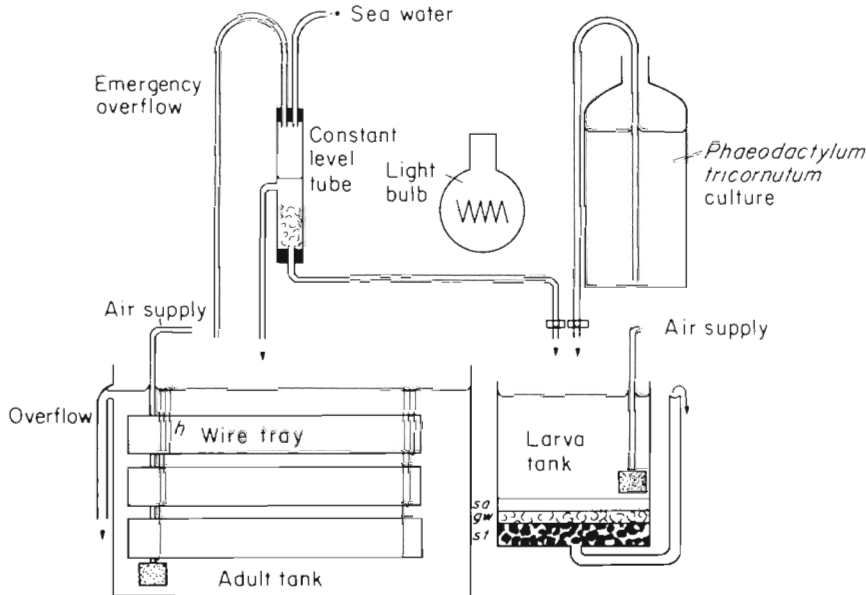

Fig. 5-51: Culture system for maintaining adults (left enclosure: 60 × 30 × 30 cm) and for rearing larvae (right: 30 × 20 × 20 cm) of *Elminius modestus*. *h* hook; *sa* sand layer; *gw* glass wool; *st* stone layer. (After WISELY, 1960; modified; reproduced by permission of CSIRO.)

approximately 50% of the original settlement, with the mortalities occurring mainly in the first 3 weeks.

Details on reproductive behaviour and breeding cycle of *Elminius modestus* have been studied under *in situ* conditions by CRISP and DAVIES (1955) in individuals grown on glass slides. Viewed from below, the reproductive condition can be determined visually through the transparent membranous base. The glass plates (ca 10 × 8 × 0.6 cm) were fitted into bakelite frames and suspended from a raft at a water depth of 1.8 m. Initial settlements were obtained in habitat areas with a high abundance of *E. modestus*, resulting in attachments of 50 to 100 spat cm⁻² in June and July. When the settled individual reached maturity, the condition of the female gonad was observed regularly. As in other cirripedes, each breeding cycle of *E. modestus* is initiated by copulation, oviposition and fertilization of the eggs in the mantle cavity. Here the eggs develop and, eventually, the embryos are released

through the opercular opening. In spring and summer, fecundity is presumably limited by the rate of embryo development, in autumn and winter by the nutrients available. *E. modestus* can breed during any season, provided the temperature does not fall below 6° C and the food supply is adequate.

Pollicipes polymerus

The gooseneck barnacle *Pollicipes polymerus* has been cultivated by LEWIS (1975) in ultra-violet-treated, Millipore-filtered sea water to which antibiotics had been added. Larval cultures were maintained at 12° to 13° C (spring) or 13° to 16° C (summer) and exposed to continuous overhead illumination from 20-W fluorescent tubes.

The *Pollicipes polymerus* larvae were fed several species of unicellular algae; they grew best on a combination of *Prorocentrum micans* and *Platymonas* sp. Comparative experiments revealed maximum growth rates in cultures maintained under conditions closely simulating those in the adult barnacle's mantle cavity (e.g. darkness, high levels of dissolved oxygen, water movement).

Other Species

Additional papers pertaining to cultivation of barnacles have been published by ISHIDA and YASUGI (1937), YASUGI (1937), BARNES and POWELL (1953), BARNES (1955) and COSTLOW (1959). Larvae of *Balanus amphitrite communis*, *B. tintinnabulum*, *B. trigonus* and *Tetraclita squamosa* have been reared under laboratory conditions by HIRANO (1952). The food source offered to these barnacles, all of which are important inhabitants of Japanese waters, was the cultured diatom *Skeletonema costatum*. KARANDE (1974b) studied larval development of laboratory-reared *Tetraclitella karandei*.

Lepas anatifera, an oceanic barnacle, has been reared by MOYSE (1964) using his beaker technique (Pyrex glass beakers; flagellate diet). The extremely fragile larvae have been described by MOYSE in considerable detail.

Attempts to rear larvae of parasitic Rhizocephala date back to DELAGE (1884), who was the first to raise *Sacculina* sp. nauplii to the cypris stage. Obtained from adults with ready-to-hatch nauplii, the freshly hatched larvae were transferred to culture dishes with stagnant, non-aerated sea water (see also SMITH, 1907). VEILLET (1943, 1947, 1951, 1952) raised nauplii of *Gemmosaccus sulcatus*, *Lernaeodiscus galatheae* and *Septosaccus cuenoti*, and YANAGIMACHI (1961) raised nauplii of *Peltogaster paguri* and *Peltogasterella gracilis*. A major obstacle was frequent adhesion of the larvae to the water surface, causing most of the larvae to die. Powdered cetyl alcohol (C₁₆H₃₃OH; extracted from spermaceti), spread thinly over the water surface, and renewed once or twice a week, helped to avoid surface adhesion without apparent damage to the larvae. With cetyl alcohol, cultivation was successful ('very low mortality') in glass containers (5 to 15 cm wide, 10 to 20 cm deep) filled with freshly filtered sea water, changed at intervals of 1 or 2 days. According to YANAGIMACHI, cetyl alcohol can also be used effectively to cultivate other marine animals which otherwise tend to adhere to the water surface.

Cirripedia as Assay and Food Organisms

Cirripedes have been used for assaying effects of toxicants. PYEFINCH and MOTT (1948) reported sensitivity of barnacle larvae and adults to copper and mercury. CORNER and SPARROW (1956) examined copper and mercury poisoning in *Elminius modestus*, and CORNER and co-authors (1968) used *E. modestus* for evaluating the toxicity of oil-spill removers (detergents). A technique for rearing larvae of *E. modestus* to be used as assay organisms for assessing anti-fouling toxicants has been developed by TIGHE-FORD and co-authors (1970) (see also FREIBERGER and COLOGER, 1966). *Balanus balanoides*, *E. modestus* and *Lepas anatifera* accumulate zinc, mostly in tissues associated with the gut (WALKER and co-authors, 1975). The level of zinc in soft-body tissue generally reflected well the level of zinc in the ambient water. Hence, barnacles may be useful indicators of zinc pollution (Volume V). Further research along these lines holds considerable promise.

Cirripede eggs and larvae may turn out to be convenient food for a variety of invertebrates and fishes. Detailed experiments remain to be conducted.

Cirripedia: Conclusions

Following a number of failures, several Cirripedia are now being successfully kept under culture conditions. A major reason for the limited success of early investigators to rear cirripede larvae seems to have been inadequate nutrition. It is important to provide proper food concentrations, as well as a sequence of different food organisms which parallels progressing individual growth and development. The cirripedes examined display species-specific differences in food selection. Suitable food sources are phytoplankters (e.g. *Asterionella japonica*, *Chlamydomonas* sp., *Chrysochromulina ericina*, *C. brevifilum*, *Ditylum brightwellii*, *Hemiselmis rufescens*, *Isochrysis galbana*, *Phaeodactylum tricorneratum*, *Skeletonema costatum*), small zooplankters, eggs of invertebrates (e.g. of *Arbacia punctulata*), dry foods such as liver powder and, presumably, detritus plus attached bacteria. The food value to cirripede larvae of various unicellular algae is listed in Fig. 5-50.

Essential steps of cirripede cultivation are: (i) isolate ripe egg lamellae from healthy adults; (ii) transfer egg lamellae to culture enclosures containing filtered sea water; (iii) add food organisms (if necessary also antibiotics); (iv) avoid direct sunlight or high levels of illuminance; (v) prevent larval stranding in the peripheral meniscus by using black glass or by attaching black tape to the outside of the culture enclosure; (vi) renew culture water and food supply every second day; (vii) provide a proper substratum for larval setting; (viii) adjust light, temperature and salinity conditions to species' specific requirements; (ix) condition adults for breeding by providing proper changes in illumination, temperature and nutrition.

In general, warm-water Cirripedia have been accommodated in culture with more success than cold-water forms. Cirripedes could be conveniently used as assay organisms. It would be easy, for example, to expose substrate panels with settled juveniles or adults to water bodies to be examined for water quality. The importance of cirripedes as food organisms is largely restricted to their larvae. These, however, could provide important food sources for a variety of cultured marine invertebrates and fishes.

(d) Malacostraca

More than 70% of all crustaceans belong to the subclass Malacostraca. The culture methods applied for supporting malacostracans under controlled conditions are more uniform than those used in the different taxa of lower invertebrates. Practically identical methods have been used in hundreds of cases, especially by investigators analyzing larval development and life histories. In view of this fact and the large number of studies that qualify for inclusion, only a few examples have been presented in some detail. It is our hope that the examples chosen are sufficiently representative to provide a basis for generalizations.

We briefly consider here efforts made in the cultivation of Mysidacea, Isopoda, and Amphipoda, and concentrate on Euphausiacea and Decapoda. Among these groups, the decapods have been studied most thoroughly.

Mysidacea, Isopoda, Amphipoda

Members of the orders Mysidacea, Isopoda and Amphipoda have been cultivated in small enclosures (e.g. beakers, finger bowls, Boveri dishes, Fig. 2-23, p. 58) in non-running, but regularly renewed, culture water. Frequently, small-container cultures were not aerated. Only in a few cases, mostly for mass cultures, have larger culture enclosures been used (e.g. jars, aquaria, fibre-glass tanks). In these cases, the culture water was usually aerated, and often recirculated and filtered (Chapter 2). Planktonic mysidaceans have developed best in culture systems with recirculated, rotating water, e.g. in devices such as the planktonkreisel (Fig. 2-136, p. 225).

Many benthic isopods and amphipods require or prefer the provision of hiding places (for example, plants, mollusc shells, stones) or substrata such as sand or gravel (e.g. KINNE, 1953). Most forms prefer dim light or quasi darkness to direct sunlight.

The nutritional preferences of mysids, isopods and amphipods may vary in different species, but several food items have been used successfully in numerous cultures. Benthic forms have been grown on detritus containing bacteria, fungi or protozoans; plants such as diatoms, *Enteromorpha linza*, *Ulva lactuca*, fresh pieces of garden lettuce, spinach, potatoes, wheat grains or dead leaves (for example, of *Alnus* sp.); living animals such as oligochaetes (e.g. *Enchytraeus albidus*, freshly cut pieces of *Lumbricus terrestris*); pieces of molluscs (e.g. *Mytilus edulis*, *Mya arenaria*), crustaceans (e.g. *Carcinus maenas*, *Crangon crangon*) and fishes (e.g. *Solea solea*, *Clupea harengus*); boiled body parts of molluscs and other animals; beef liver; gonads of a variety of invertebrates, including echinoderms. In addition, various dry foods such as trout or catfish feed, 'Tetramin' and other commercial fish foods have been used successfully—especially with cultured gammarids. Planktonic forms have been fed a variety of phytoplankton, copepods, rotifers, *Artemia salina* and organic detritus particles. Some benthic and planktonic representatives filter-feed. Even the boring isopod *Sphaeroma quoyanum* is assumed to be primarily a filter feeder straining small particles from a self-propelled water current (ROT-RAMEL, 1975).

Euphausiacea

Pelagic, with shrimp-like bodies, the 94 species of the evolutionary primitive Euphausiacea are all marine. Most euphausiaceans are suspension feeders. Their first 6 thoracic appendages form a filter. The feeding current, produced by swimming, passes through a basket or net formed by endopodite setae. Small phyto- and/or zooplankters serve as major food sources for most representatives. Very few euphausiids are predators, e.g. *Stylocheiron* species, which hunt larger plankters. The euphausiaceans comprise a major portion of the oceanic plankton biomass and constitute an important link in the oceanic food chain. They are favoured as food by several of the large whales. A moderate-sized blue whale *Balaenoptera musculus* may consume 2 to 3 tons of euphausiids at one feeding (SCHMITT, 1910).

Most early attempts to cultivate euphausiaceans failed. BAKER (1963) managed to keep euphausiids alive on board ship for a maximum period of 15 days, and LASKER (1964) maintained *Euphausia pacifica*, the most abundant euphausiid off the coast of California (USA), for 50 days on a diet of *Dunaliella primolecta* and *Platymonas subcordiformis* (see also JERDE and LASKER, 1966). Further examples of short-term euphausiid cultivation are listed in Table 5-48. Little is known about the conditions required for long-term sustenance and for reproduction in most of these planktonic open-ocean dwellers.

Reviewing the literature on euphausiid cultivation, KOMAKI (1966) estimates the average swimming speed of *Euphausia pacifica*, *Thysanoëssa spinifera* and *T. inermis* to be about 0.5 m sec^{-1} (maximum ca 1.0 m sec^{-1}). Unless quantitative sampling is required, KOMAKI recommends that, for collection purposes, towing speeds should not exceed 2 knots; faster towing tends to cause damage to the euphausiids. He used a nylon bag of about 3.5-l capacity clamped to a plastic cylinder (cod end), and suggests that the last part of the net be shaped like a lantern, rather than using the usual conical shape, in order to reduce the speed of water movement.

Early developmental stages of euphausiids do not feed (GAULD, 1959). According to KOMAKI (1966), the first active feeding stage is the calyptopis. In *Euphausia pacifica*, *Thysanoëssa spinifera* and *T. inermis*, the first calyptopis has been shown to accept diatoms, such as *Skeletonema costatum*. However, smaller unicellular algae seem to represent better food for young stages. While green flagellates such as *Dunaliella* sp. may be acceptable, flagellates tend to adhere to appendages and body surfaces of euphausiids and thus to impede swimming. Later euphausiid stages can be cultured on nauplii of *Artemia salina* and, presumably, on rotifers (e.g. *Brachionus plicatilis*, p. 679).

According to KOMAKI (1957), *Euphausia pacifica* of 20 and 25 mm total length consume, on average, $15.5 \text{ Artemia salina}$ nauplii hr^{-1} . This figure is higher than that obtained by LASKER (1966), who concludes that 1-year-old *E. pacifica* must capture between 100 and 200 nauplii day^{-1} , and 2-year olds, 200 to 300, in order to satisfy their carbon requirements. Table 5-49 summarizes the information available on moulting frequencies.

An improved, and now routine, method for maintaining and raising adult *Euphausia pacifica* in the laboratory has been developed by LASKER and THEIL-HACKER (1965), who report that once *E. pacifica* has been established in the culture enclosures (white, translucent, polystyrene containers of 1-litre capacity) for a

Table 5-48

Euphausiid species reared under laboratory conditions: maximum length of survival periods and food offered. d: day(s); w: weeks (After KOMAKI, 1966; modified; based on the sources indicated)

Species	Max. period of survival	Food	Author
<i>Euphausia pacifica</i>	1 d*	<i>Dunaliella primolecta</i>	LASKER (1960)
<i>Euphausia pacifica</i>	25 d*	<i>Artemia salina</i> nauplii, mussel larvae, phyto- and zooplankton, mud particles	KOMAKI (1966)
<i>Euphausia pacifica</i> <i>Thysanoëssa inermis</i> <i>Thysanoëssa spinifera</i>	30 d*	<i>Artemia salina</i> nauplii	KOMAKI (unpublished)
<i>Euphausia pacifica</i>	40 d*	<i>Platymonas</i> sp.	PARANJAPE (in:
<i>Tessabrachion oculatus</i>	12 d*	<i>Coscinodiscus angstii</i> ,	KOMAKI, 1966)
<i>Thysanoëssa longipes</i>	30 d*	<i>Skeletonema costatum</i> ,	
<i>Thysanoëssa raschii</i>	30 d*	<i>Thalassiosira rotula</i> ,	
<i>Thysanoëssa spinifera</i>	30 d*	<i>Artemia salina</i> nauplii	
<i>Euphausia eximia</i>	19 d	No food	JERDE and LASKER (1966)
<i>Euphausia gibboides</i>	8 d	<i>Artemia salina</i> nauplii	
<i>Euphausia pacifica</i>	44 d		
<i>Euphausia recurva</i>	7 d		
<i>Nyctiphanes simplex</i>	20 d*		
<i>Thysanoëssa aequalis</i>	4 d		
<i>Thysanoëssa spinifera</i>	20 d*		
<i>Euphausia pacifica</i>	50 d	<i>Dunaliella primolecta</i> , <i>Platymonas subcordiformis</i>	LASKER (1964)
<i>Euphausia eximia</i> <i>Euphausia pacifica</i> <i>Nematoscelis difficilis</i>	indefinite	<i>Artemia salina</i> nauplii	LASKER and THEILACKER (1965)
<i>Meganyctiphanes norvegica</i>	9 w (dark) 15 d (light)	Copepods, mud	MACDONALD (1927)
<i>Euphausia brevis</i>	7 d		BAKER (1963)
<i>Euphausia hemigibba</i>	3 d		
<i>Euphausia krohnii</i>	8 d		
<i>Meganyctiphanes norvegica</i>	15 d		
<i>Nematobrachion sexspinosus</i>	1 d		
<i>Nematoscelis</i> spp.	6 d		
<i>Thysanopoda</i> spp.	2 d		
<i>Thysanopoda tricuspidata</i>	2 d		

Table 5-48—Continued

Species	Max. period of survival	Food	Author
Unidentified (<i>Thysanoëssa</i> , <i>Meganyctiphanes</i> , <i>Nematoscelis</i>)	15 d	<i>Skeletonema</i> <i>costatum</i> <i>Thalassiosira</i> <i>fluviatilis</i>	CONOVER (1960)

* Experiment was terminated

few days, there is virtually no mortality. LASKER and THEILHACKER caught *E. pacifica* in plankton tows (250–300 m depth) never exceeding 15 min duration. They used a 1-m-mouth-diameter plankton net with a 1-l cod end. On board ship, the catch was emptied into a yellow polyethylene bucket. This facilitates sorting because of the ease with which the euphausiids can be seen. After transportation (no more than 5 individuals l⁻¹), *E. pacifica* was transferred into the culture enclosures (1 individual for each 1-l container), and the sea water was changed at least twice a week. Maximum mortalities occurred during the first 2 days, presumably due to collection and handling. All subsequent transfers were done by drawing each *E. pacifica* into a wide-mouthed (6 mm internal diameter) pipette and by transferring it with a small quantity of water. Each euphausiid was supplied with several thousand newly hatched *Artemia salina* nauplii, and the containers were covered with black polyethylene sheeting. The resulting darkness favours an even distribution of the nauplii and thus makes them more available to *E. pacifica*. Single *E. pacifica* or *E. eximia* filter out and ingest as many as 70 to 95 nauplii day⁻¹ (total offer: 100 nauplii).

Euphausia pacifica moults at intervals of 3 to 8 days depending on temperature (LASKER, 1966), and may grow as rapidly as 0.048 mm day⁻¹. This is more than twice as fast as the growth observed in oceanic populations (0.02 mm day⁻¹) by other workers (e.g. PONOMAREVA, 1959). Respiration accounts for the major portion of the carbon assimilation (62–87%); moulting, growth and reproduction account

Table 5-49

Moulting frequency of cultured euphausiids. Within the range tested (8° to 17.5° C), moulting intervals are not significantly affected by temperature (After KOMAKI, 1966; modified; based on the sources indicated)

Species	Moulting interval	Author
<i>Euphausia pacifica</i>	1/5 ± 1 d	LASKER (1964)
<i>Euphausia eximia</i>	1/4 – 6 d	JERDE and LASKER
<i>Euphausia pacifica</i>	1/5 – 6 d	(1966)
<i>Nyctiphanes simplex</i>	1/5 – 7 d	
<i>Thysanoëssa spinifera</i>	1/5 – 6 d	
<i>Euphausia pacifica</i>	1/4 – 5 d	PARANJAPÉ
<i>Tessarabrachion oculatus</i>	1/4 d	(in: KOMAKI, 1966)
<i>Thysanoëssa longipes</i>	1/5 d	
<i>Thysanoëssa raschii</i>	1/6 d	
<i>Thysanoëssa spinifera</i>	1/5 d	

for the remainder. In mature *E. pacifica*, 9% of the assimilated carbon was released with the eggs. Rapidly growing individuals incorporated as much as 30% of the carbon assimilated, but calculations for an oceanic population gave only 9% (excluding eggs and moults) over the individual's life span. Moulting occurs mainly at night. According to PEARCY and co-authors (1969), there is no evidence for diel rhythms in respiration.

Nematoscelis difficilis has been cultivated by GOPALAKRISHNAN (1972), who offered phytoplankters as food for the larvae. The latter did not eat *Artemia salina* nauplii. Though similar to *N. megalops*, the development of *N. difficilis* differs from that of other species of the genus *Nematoscelis*. While no mortality occurred in metanauplii of *N. difficilis*, up to 40% of the calyptopes died 11 days after hatching. Average growth rates ranged from 0.04 to 0.16 mm day⁻¹.

Essentials of euphausiid cultivation may be summarized as follows: (i) Collection is difficult due to the sometimes great depth inhabited, high motility and fragility. Hence, speed and duration of towing must be determined with care. Injuries can be reduced by specifically designed nets (wide mouth, large cod end), avoidance of rapid and extensive changes in temperature and hydrostatic pressure, and collection at a time when the euphausiids approach surface waters. (ii) Newly collected euphausiids must be accommodated under environmental conditions close to those in their habitat in a sufficient volume of habitat water and in dim light or darkness. White, yellow or blue backgrounds provide contrast to the red pigments of the otherwise transparent euphausiids and thus facilitate recognition. Injured individuals should be removed as soon as possible. (iii) Handling requires special precautions. Wide-mouthed pipettes and cups are best for transfer of individuals. (iv) Aeration should be applied in such a way as to avoid direct contact with air bubbles (Chapter 2). (v) Smooth-walled, round, covered culture containers give best results. (vi) Overfeeding must be avoided, and non-eaten food remains must be removed immediately. (vii) At least 1 l of filtered sea water should be allowed for each individual of 15 to 20 mm length, and temperature, salinity and water quality should be closely controlled and maintained within near-optimum ranges. (viii) Unless running sea water is provided, the culture water must be renewed every other day. While *Artemia salina* larvae support growth satisfactorily, adequate food sources are still a matter of research. The commercial importance of krill receives brief attention in Chapter 5.2.

Decapoda

General Aspects

Decapoda is the largest order (approximately 8700 known species) and comprises the largest-sized members of the class Crustacea. Its two suborders—*Natantia* (shrimps and prawns) and *Reptantia* (lobsters, crayfish and crabs)—contain, respectively, laterally compressed swimmers with a well-developed abdomen and predominantly crawlers with more or less dorso-ventrally flattened bodies.

While ecological studies on captive decapods are still few in number, many investigators have concentrated on taxonomy and life cycles, as well as on commercial aspects of decapod cultivation. The former investigators maintained develop-

mental stages for one or several moults, often without feeding. In this way, the structure and sequence of post-embryonic stages have been explored. Gradually, successive stages of a given life cycle could be linked together and, in some cases, identification became possible of otherwise undeterminable forms. Commercial interests are based on the appreciation of decapods as seafood. Many shrimps and prawns, as well as lobsters, are delicacies and practically all are edible. Consequently, it is not possible here to divide the Natantia and Reptantia satisfactorily into species to be covered under *Research Cultivation* (Chapter 5.1) and *Commercial Cultivation* (Chapter 5.2), respectively. For this reason, and because

Table 5-50

Principal larval stages and types of post-embryonic development in decapods (After R. D. BARNES, 1963; based on WATERMAN and CHASE, 1960; reproduced by permission of Saunders Co.)

Group	Larvae	Post-embryonic development
Suborder Natantia		
Family Penaeidae	Nauplius → protozoa → mysis → mastigopus (zoea) (postlarva)	Slightly metamorphic
Family Sergestidae	Nauplius → elaphocaris → acanthosoma → mastigopus (protozoa) (zoea) (postlarva)	Metamorphic
Section Caridea	Protozoa → zoea → parva (postlarva)	Metamorphic
Section Stenopodidea	Protozoa → zoea → postlarva	Metamorphic
Suborder Reptantia		
Section Macrura		
Superfamily Scyllaridea	Phyllosoma → puerulus, nisto, or pseudibaccus (zoea) (postlarva)	Metamorphic
Superfamily Nephropsidea	Mysis → postlarva (zoea)	Slightly metamorphic
Section Anomura	Zoea → glaucothöe in pagurids, grimothea (postlarva)	Metamorphic
Section Brachyura	Zoea → megalopa (postlarva)	Metamorphic

Chapter 5.2 is devoted to principle rather than to detail, all cultured Natantia and Reptantia are treated in the following two sections.

As in many other marine animals, the most crucial point of decapod cultivation is to accommodate their larvae. Success in cultivation depends primarily on whether the culturist is able to provide adequate environmental and nutritional conditions during early ontogeny. The principal larval stages of decapods are listed in Table 5-50. While environmental requirements are reviewed in context with the species concerned, we have devoted a special section to nutritional requirements.

Only a few decapods have thus far reproduced under laboratory conditions. In most cases, eggs or larvae have been collected from the sea—either from ovigerous

females or from the plankton. As our know-how on decapod nutrition and our capacity for managing culture-water quality increases, more and more decapods will become available for breeding experiments, and in commercial forms stock improvement may become routine.

Large numbers of eggs or larvae of comparable age and environmental history can best be obtained from gravid females. Except for penaeids, which shed their eggs into the water, female decapods incubate their eggs while attached to their abdominal appendages. Even though there is no direct physiological connection between egg and female, the latter provides conditions beneficial to embryo development (water current, oxygenation, cleaning, protection from predators; to some degree, also infection control). Consequently, many experimental ecologists have left the eggs in the female's care and allowed them to hatch naturally (RICE and WILLIAMSON, 1970). However, gravid females may be moribund from sampling, difficult to maintain (deep-water species), or they may discard or eat their eggs. Removal, subdivision and artificial incubation of the usually voluminous egg masses with hundreds or thousands of eggs makes it possible to conduct parallel experiments under different conditions (e.g. of light, temperature, salinity, water movement, nutrition or environmental pollution).

Modern mass-culture systems, designed for commercially valuable decapods, but useful also for other forms, have been described by MOCK (1974), MOCK and NEAL (in press) and PARKER (in press). A variety of related systems and important culture devices has been presented in Chapter 2.

Nutritional Requirements

Most of the decapods kept under laboratory conditions have been offered food that happened to be available or that was assumed to be acceptable. Critical, detailed investigations into the nutritional requirements of decapods have just started, and our present knowledge on decapod nutrition is still rather preliminary. From the information available, it seems that requirements common to all decapods outweigh the differences occasionally observed in some species. In fact, there is evidence that protein requirements and optimum amino-acid composition in the food, as well as mineral and vitamin requirements, are quite similar in such groups as shrimps, lobsters and crabs. Consequently, we have treated here the reports on nutritional requirements of decapods in one sub-section.

Wherever possible, future investigations into nutritional requirements should contain information on: (i) culture environment, e.g. light, temperature, salinity; (ii) type of culture system, e.g. size and shape of culture enclosure, water treatment, carrying capacity, turnover rate; (iii) source and history (environmental, nutritional) of food organisms (cultured algal food must be washed free from its own culture medium prior to use as food); source and pretreatment of non-living foods; (iv) chemical composition and calorific value of food items; (v) food-particle size and concentration.

Natural food sources

Experimental ecologists must attempt to offer the animals cultivated natural food sources. Only in this way can they produce information in their experiments

that may be extrapolated to field conditions. Conceivably, 'unnatural' foods may not only lead to differences in environmental tolerance, metabolism, growth and reproduction, but also in behaviour (prey catching; stimuli input). Additional, critical studies are needed on wild populations, investigating stomach contents, feeding habits, food selection and food consumption under *in situ* conditions. As in most other marine animal groups, our present knowledge on natural food sources of decapods is meagre—often entirely insufficient.

Cultured lobsters and some other decapods tend to lose their natural colour and, with successive moulting steps, turn increasingly blueish. The blue colour signals inadequate nutrition or, at least, that the food provided differs from that normally consumed under *in situ* conditions.

Many decapods are omnivorous—frequently with a tendency to favour animal food. Several forms have been shown to change during their life history from primarily herbivorous to primarily carnivorous feeding. More decapods than originally assumed appear to require at least minute portions of plant food in order to cover their vitamin requirements. In some cases, sufficient vitamins may be acquired via the intestines of plant-eating prey.

In captivity, decapods such as shrimps, lobsters and crabs accept a large variety of food items—ranging from plants over invertebrates and fishes to commercial fish foods and trash foods, i.e. remains of foods used for human consumption. The diets consumed by reared decapod larvae include phytoplankton algae such as species of *Dunaliella*, *Chlorella*, *Micromonas*, *Tetraselmis*, *Hemiselmis*, *Ditylum*, *Prorocentrum*, *Isochrysis*, *Navicula*, *Nitzschia*, *Skeletonema* and *Phaeodactylum*, and zooplankters such as rotifers and copepods, as well as eggs and larvae of annelids, cirripedes, molluscs, echinoderms and fishes.

Diets offered in culture experiments

In general, single-component diets are less likely to meet all nutritional requirements of the decapod cultivated than are multi-component (mixed) diets. Multi-component diets lessen the danger of malnutrition, especially in cases where the absolute nutritional requirements are not, or insufficiently, known. Of particular importance are mixed plant-animal diets.

An example of a single-component diet offered to cultivated decapods is the brine shrimp *Artemia salina*. Larvae or adult brine shrimp have been used as sole food source for numerous natantian and reptantian larvae, juveniles and adults. However, in a few cases, results have been obtained which are indicative of an unbalanced diet. Thus, larvae of *Palaemon serratus* fed newly hatched or 24-hr-starved *A. salina* nauplii (Utah strain) could complete their development to the post-larval stage only if the alga *Isochrysis galbana* was added to the cultures, or if the *A. salina* nauplii had been fed *I. galbana* prior to being offered to the prawn larvae (WICKINS, 1972). This observation indicates a requirement for a growth factor contained in the plant tissue (possibly a vitamin).

DEXTER (1972) reared larvae of the scyllarid *Panulirus interruptus* on fish larvae, nauplii and metanauplii of *Artemia salina*, or pieces of ctenophores and chaetognaths (Table 5-51). Since neither fish larvae, ctenophores nor chaetognaths were available in sufficient numbers, DEXTER used *A. salina* larvae as main food

Table 5-51

Panulirus interruptus. Effect of diet on survival (number and percentage of larvae) and on maximum age attained (days) of phyllosoma larvae (After DEXTER, 1972; modified; not copyrighted)

Larval stage	Food organism							
	<i>Mytilus</i> sp. (gonad)	<i>Lytechinus</i> sp. (eggs)	<i>Tubifex</i> sp.	Fish larvae	<i>Artemia salina</i> (nauplii)	<i>Artemia salina</i> (nauplii)	<i>Artemia salina</i> (metanauplii)	Ctenophores Chaetognaths
I	80 100%	64 100%	80 100%		80 100%	64 100%	64 100%	136 100%
II	0 0%	1 2%	2 3%		28 35%	26 41%	38 60%	81 60%
IIIa	—	0 0%	0 0%	54 100%	3 4%	18 28%	22 35%	42 31%
IIIb	—	—	—	36 67%	0 0%	7 11%	5 8%	13 10%
IIIc	—	—	—	15 28%	—	5 8%	4 6%	4 3%
IIId	—	—	—	8 15%	—	2 3%	0 0%	4 3%
IV	—	—	—	1 2%	—	1 1%	—	4 3%
V	—	—	—	1 2%	—	—	—	4 3%
Maximum age attained (days):	18	22	24	21*	35	49*	37	49*

* Experiment terminated due to unavailability of food.

source. Considerable variation was obtained in survival and growth of phyllosome larvae, depending on the source of *A. salina* (see also p. 759).

As in most other natantians, the early larvae of the mesopelagic *Sergestes lucens* are first predominantly herbivorous (nauplius, elaphocaris, acanthosoma), later carnivorous (postlarvae). Survival rates of larvae, offered three different algal diets, have been studied by OMORI (1971; see Table 5-52). Good food for early larvae is the diatom *Chaetoceros ceratosporum*; for postlarvae, *Artemia salina* nauplii. As larval development proceeds, structural modifications occur in the feeding appendages; these modifications parallel changes in feeding habit. Moulting occurs predominantly at night. The principal foods for larvae and early postlarvae of *Penaeus japonicus* are listed in Table 5-53.

Table 5-52

Sergestes lucens. Number and percentage (in parentheses) of larvae surviving to the developmental stage indicated when offered 3 different algal diets. 20° C; 33.9‰S (After OMORI, 1971; reproduced by permission of Springer-Verlag)

Stage	<i>Chaetoceros ceratosporum</i>	<i>Chlorella sp.</i>	<i>Phaeodactylum tricornutum</i>
Egg	50 (100)	26 (100)	25 (100)
Nauplius I	48 (96)	24 (93)	24 (96)
Nauplius II	44 (88)	22 (85)	23 (92)
Elaphocaris I	41 (82)	21 (81)	21 (84)
Elaphocaris II	20 (40)	7 (27)	12 (48)
Elaphocaris III	16 (32)	3 (11)	8 (32)
Acanthosoma I	10 (20)	0	0
Acanthosoma II	9 (18)		
Postlarva I	9 (18)		
Postlarva II	9 (18)		
Postlarva III	8 (16)		
Postlarva IV	8 (16)		
Postlarva V	8 (16)		

Larvae of the palaemonid shrimp *Macrobrachium rosenbergii* develop well on a mixed diet of *Artemia salina* nauplii or fish eggs (*Mugil* sp.), supplemented with phytoplankton, powdered chicken blood or a vitamin-fortified mixture of fish flesh and egg custard steamed together, drained and passed through a screen to provide particles of appropriate sizes (LING, 1969b). Daily food rations were provided at the rate of 30% of the total larval body weight. Food-particle size must be adjusted to larval age. The particle sizes found suitable for *M. rosenbergii* larvae of different age (size) are listed in Table 5-54.

The nutritional value of mixed diets for newly hatched larvae of the shrimp *Palaemonetes pugio* and *P. vulgaris*, kept individually in 10-cm finger bowls, has been investigated by BROAD (1957a). Larval morphology and developmental stages are quite similar in *P. pugio* and *P. vulgaris*. While some larvae received no food, the others were offered a variety of food combinations. For each larva, the diet remained the same throughout its lifetime. The diet included two undetermined

species of *Nitzschia* and one undetermined species of each of the following genera: *Chlamydomonas*, *Thorocomonas*, *Nannochloris*, *Porphyridium* and *Pyramimonas*, as well as freshly killed chaetognaths, tiny bits of visceral mass of the mud snail *Nassarius obsoletus*, or nauplii of *Artemia salina*. The numbers of larval moults and of the survivors obtained are listed in Table 5-55. Apparently, the algae were of

Table 5-53

Penaeus japonicus. Principal foods for larvae and early post-larval stages (Based on information provided by HUDINAGA and KITTAKA, 1966, 1967)

Nutrients	Zoea	Mysis	Early postlarva	Advanced postlarva
<i>Skeletonema costatum</i>	+	+		
Mixed plankton	+	+	+	+
Benthic diatoms	+	+	+	+
Eggs and early larvae of oysters	+	+		
Copepods			+	
Frozen oyster eggs	+	+		
Annelids				+
<i>Artemia salina</i>		+	+	
Short-necked clam				+
Fish cake				+
Artificial food (?)				+

little or no nutritional value to the larvae (see also BROAD, 1957b). Only when offered algae plus animal tissue, or animal tissue alone, did some larvae survive to the post-larval stage. The larvae usually swim near the water surface; hence, non-motile food sinks untouched to the bottom of the bowls. Contact between zoeae and food particles seems to be the result of chance encounters rather than active, aimed search.

Table 5-54

Macrobrachium rosenbergii. Food-particle size acceptable to larvae of different ages (After LING, 1969a; modified; reproduced by permission of FAO)

Larval age (days)	Size of food particles (mm)
2-4	0.4
5-10	0.5
11-20	0.9
>20	1.4

Larvae of the prawn *Penaeus japonicus* have been raised on a mixture of soy-cake particles and diatoms by HIRATA and co-authors (1975). Soy cake, a by-product of soy-bean fermentation, was homogenized and filtered through a net to produce small, detritus-like particles. Maximum survival (85.9%) occurred in a culture

Table 5-55

Palaemonetes pugio and *P. vulgaris*. Number of larval moults and of surviving postlarvae obtained with different foods. 25° to 27° C; unfiltered sea water (After BROAD, 1957a; modified; reproduced by permission of the Biological Bulletin)

Number of moults	<i>Palaemonetes pugio</i>						<i>Palaemonetes vulgaris</i>			
	Unicellular algae	Algae plus animal tissue	Animal tissue	Nauplii of <i>Artemia salina</i>	Without food	Unicellular algae	Algae plus animal tissue	Nauplii of <i>Artemia salina</i>	Without food	
0	280	608	732	100	60	100	667	390	80	
1	162	491	464	92	42	1	30	324	0	
2	0	143	177	87	0	0	15	282	0	
3	0	77	84	87	0	0	13	261	0	
4	0	54	70	85	0	0	11	227	0	
5	0	47	50	82	0	0	11	191	0	
6	0	37	36	82	0	0	9	149	0	
7	0	29	28	69	0	0	8	131	0	
8	0	24	25		0	0	8		0	
9	0	18	14		0	0	8		0	
10	0	17			0	0			0	
11		17			0	0			0	
Number of postlarvae:	0	16	6	65	0	0	6	122	0	

receiving soy cake in quantities of $0.16 \text{ mg zoea}^{-1} \text{ day}^{-1}$. Comparing the nutritional values of soy cake alone, *Chaetoceros rigidus* alone, and of a half-and-half mixture of the two, best growth and survival were obtained in larvae fed the mixture. Encouraged by their results, HIRATA and co-authors suggest that soy-cake 'detritus' can be successfully used as mass-culture feed. The chemical composition of soy cake, of the diatoms *Skeletonema costatum* and *C. simplex* and of marine yeast are listed in Table 5-56. VENKATARAMIAH and co-authors (1975) provided larvae of *P. aztecus* with a single-component diet (*Artemia salina* nauplii) until they had

Table 5-56

Chemical composition of mixed diets (soy cake, diatoms and marine yeast) offered to larvae of *Penaeus japonicus* (After HIRATA and co-authors, 1975, based on MORIMOTO, 1970; KANAZAWA, 1969; OOSAWA and KAWANO, 1971; reproduced by permission of Springer-Verlag)

Composition	Soy cake (%)	<i>Skeletonema costatum</i> (%)	<i>Chaetoceros simplex</i> (%)	Marine yeast (%)
General composition				
Crude protein	25.6-28.1	—	22.8	34.00
Crude fat	8.2-10.3	—	18.1	1.71
Nitrogen-free extract	20.0-30.1	—	21.8	11.09
Crude fibre	12.2-22.1	—	2.1	—
Crude ash	8.2-10.1	—	35.2	9.89
Amino acids				
Arginine	1.03-1.04	10.8	4.7	3.95
Lysine	0.63-0.75	5.1	5.5	5.89
Histidine	0.41-0.66	1.3	1.6	1.64
Isoleucine	1.25-1.60	3.5	5.0	4.13
Leucine	2.10-2.30	6.3	7.8	3.25
Methionine	0.25-0.30	2.2	2.5	1.43
Cysteine	0.35-0.36	—	—	—
Phenylalanine	1.45-1.75	5.0	4.7	3.56
Tyrosine	1.81-2.19	3.8	3.6	2.30
Threonine	0.65-0.86	3.7	4.5	3.78
Tryptophane	0.05-0.50	1.0	1.5	—
Valine	1.44-1.63	5.3	5.5	4.13
Glycine	0.62-0.96	4.7	6.2	4.25

grown to a length of ca 11 mm (3.8-l glass aquaria; photoperiod: 12 hrs light; 26°C ; 30‰S , gradually lowered to 8‰S by the time the larvae had grown to 22 mm length). Later, a mixed diet consisting of dry food pellets and brine shrimp nauplii was provided.

Larvae of the American lobster *Homarus americanus* or the European lobster *H. gammarus* grow well on ground tissues of molluscs, crustaceans and fishes, whole living copepods (e.g. of the species *Acartia*, *Calanus*, *Eurytemora*, *Pseudocalanus*) and nauplii or adults (also ground frozen ones) of *Artemia salina*. Presumably, their natural food consists of small pelagic invertebrates, especially copepods, and pelagic larvae of benthic invertebrates. The larvae also accept 'unnatural' foods such as ground beef liver or ground hard-boiled eggs, but these

diets support survival and growth less efficiently. Juvenile lobsters have been offered tissue pieces of a large variety of animals. In addition, a few culturists have occasionally provided plants such as seaweeds or garden lettuce as a source of vitamins. Lobsters grow well on pieces of hepatopancreas of *Carcinus maenas* or *Cancer pagurus*, mantle pieces of molluscs such as *Mytilus edulis*, fish flesh, whole white worms *Enchytraeus albidus* or earthworms *Lumbricus terrestris*, and *A. salina*. The food value of several commercial fish foods to lobsters seems to be high.

The effect of different diets (Table 5-57) on survival and growth of *Homarus americanus* is shown in Figs 5-52 and 5-53 (SHLESER and GALLAGHER, unpublished). When offered in daily amounts equal to approximately 5% of the lobster's body weight, the diets produced different growth rates. Highest survival and fastest growth were obtained with adult *Artemia salina* (Diet 1); commercial shrimp and trout ration, as well as diets prepared at the Department of Food Science (University of California, Davis, USA), supported growth and survival less well, but markedly better than Diet 6 (raw meat of fish, abalone and clam in agar gel).

Table 5-57

Diets fed to cultured *Homarus americanus* (After SHLESER and GALLAGHER, unpublished; modified; reproduced by permission of the authors)

Diet	Contents (source)
1	Live adult <i>Artemia salina</i> from San Francisco Bay (USA)
2	Commercial shrimp ration
3	L.S.U. Dept. of Food Science
4	Commercial trout ration
5	L.S.U. Dept. of Food Science
6	Minced raw fish, abalone, clam in agar gel

The higher long-term survival of non-fed lobsters, compared to those given Diets 5 and 6 (Fig. 5-52) casts some doubt on experimental design and results.

The nutritional value for larvae of the crab *Pagurus longicarpus* of several microflagellates, shelled larvae of the oyster *Crassostrea virginica* and of post-trochophora larvae of the polychaete *Arenicola marina* has been examined by ROBERTS (1974). *Artemia salina* nauplii, known to permit complete development of *P. longicarpus* (ROBERTS, 1970, 1971b), were used as controls. The algal diets consisted of (i) a mixture of microflagellates (species of *Cyclotella*, *Dunaliella*, *Monochrysis*), and (ii) the dinoflagellate *Amphidinium klebsii*, contaminated with *Dunaliella* sp. (20 to 50%). The microflagellates were added to filtered sea water to give a final concentration of ca 10^4 cells ml⁻¹. ROBERTS gives no estimate of the concentration of *A. klebsii* provided each zoea. In neither case were the algal cells washed free of their original culture medium before use as food organisms. Approximately 20-40 oyster larvae (early umbo stage to presettlement stage) were given to each zoea daily. The post-trochophores of *A. marina* carried with them some diatoms (*Nitzschia sigmoides*); each zoea was offered 200 to 400 post-trochophores daily.

The feeding experiments were carried out in compartmented plastic boxes. The results obtained are summarized in Figs 5-54, 5-55 and 5-56.

All microflagellates tested were ingested, but did not allow survival beyond 12 days. Shelled larvae of *Crassostrea virginica* were inadequate as food source, because the *Pagurus longicarpus* larvae cannot break their shell. Post-trochophores of *Arenicola marina* supported complete larval development to the fourth zoea,

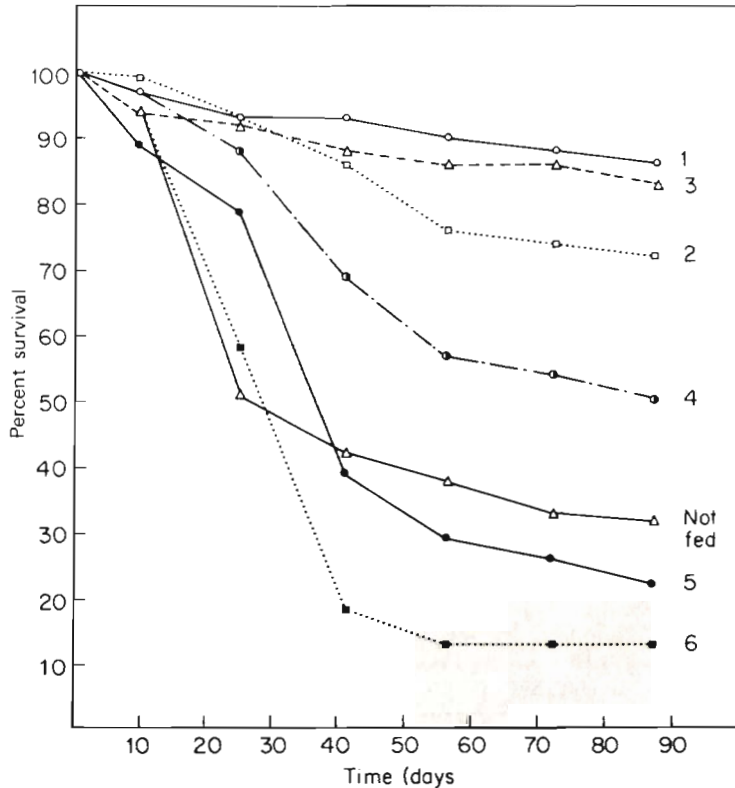

Fig. 5-52: *Homarus americanus*. Percentage survival as a function of diet. For diet key consult Table 5-57; amount of diet offered was equal to 5% lobster body weight day⁻¹. 21° C, closed sea-water system. (After SHLESER and GALLAGHER, unpublished; modified; reproduced by permission of the authors.)

comparable to the results obtained with *Artemia salina* nauplii; survival through the megalopa was higher than that in *A. salina*-fed cultures.

Early *Callinectes sapidus* larval stages survived well on the rotifer *Brachionus plicatilis* (SULKIN and EPIFANIO, 1975). However, the rotifer alone did not sustain development to the megalopa (SULKIN, 1975). Larval development was completed in larvae fed either trochophores of the polychaete *Hydroides dianthus* or a combination of *B. plicatilis* for the first 14 days followed by *Artemia salina* nauplii. In zoeal stages of *Rhithropanopeus harrisi* and *Neopanope* sp., survival to the megalopa was significantly lower in larvae fed *B. plicatilis* than in those offered *A.*

salina nauplii (SULKIN and NORMAN, 1976). The rotifer diet immediately caused a delay in moulting.

Dietary Composition

Both for research cultivation and commercial cultivation, the composition of the diets offered is of basic importance. Knowledge on diet composition is a prerequisite for nutritional analyses. Only diets that contain all essential substances can

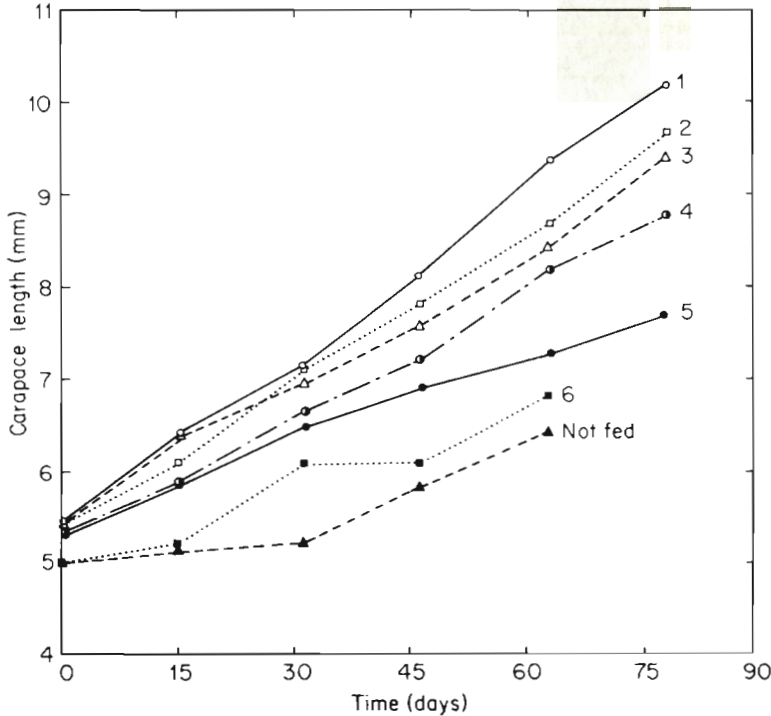

Fig. 5-53: *Homarus americanus*. Growth rate as a function of diet. For diet key consult Table 5-57; amount of diet offered was equal to 5% lobster body weight day⁻¹. 21° C, closed sea-water system. (After SHLESER and GALLAGHER, unpublished; modified; reproduced by permission of the authors.)

be expected to support the animal cultivated fully and to produce good growth at maximum food conversion efficiencies. Due to the restricted information available, we limit our discussion here to the requirements of decapods for protein, amino acids, and minerals and vitamins.

Protein

The requirements of decapods for protein appear to be considerable. Several studies have shown that diets with relatively high protein contents promote growth. KITABAYASHI and co-authors (1971d) report better growth in *Penaeus japonicus* fed a protein-rich diet (squid meal, 53.5%; squid-meal extract, 3.4%;

squid-liver extract, 12.2%; vitamin mixture, 4.2%; α -starch, 10.7%; wheat flour, 4.6%; glucosamine hydrochloride, 0.36%; $\text{CaHPO}_4 \cdot 2\text{H}_2\text{O}$, 0.87%; CaCO_3 , 2.20%; glucose, 3.57%; vitamin C, 0.04%; methionine, 0.43%; squid-liver oil, 4.38%; arginine, 0.49%) than in controls fed the usual diet of short-necked clam *Venerupis philippinarum*, the best conventional food source for cultured juvenile and adult *P. japonicus*. DESHIMARU and SHIGENO (1972) state that *P. japonicus*

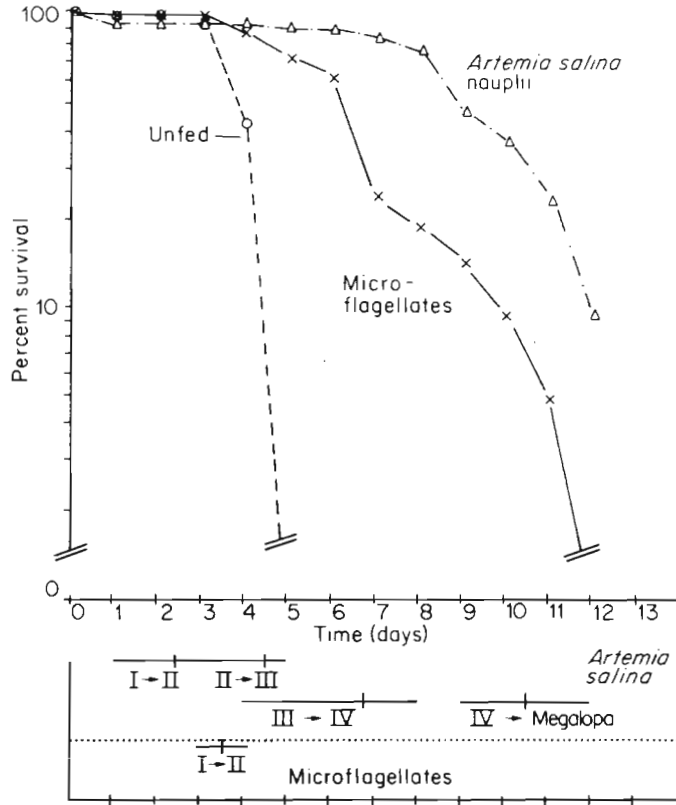

Fig. 5-54: *Pagurus longicarpus*. Survival of zoeae fed a mixture of microflagellates and nauplii of *Artemia salina*; a third group remained unfed. Bottom bars: time of moulting between the stages (roman numbers) indicated. 24° to 28° C; 20 to 21‰S. (After ROBERTS, 1974; modified; reproduced by permission of the *Biological Bulletin*.)

needs a high-protein diet for maximum growth and food-conversion efficiency, and BALAZS (1973) reports that growth rates appear to increase in *P. japonicus*, *P. aztecus* and *Macrobrachium rosenbergii* with the amount of protein in the diet.

At very high dietary protein levels (30 or 40%), ANDREWS and co-authors (1972) and VENKATARAMIAH and co-authors (1975) found a decrease in growth of white shrimp *Penaeus setiferus* and brown shrimp *P. aztecus*. In *P. setiferus*, ANDREW and co-authors recorded maximum growth at protein (largely fish meal) levels between 28 and 32%. While addition of starch enhanced growth, supplemented glucose and

lipids resulted in poor weight gains. According to VENKATARAMIAH and co-authors, *P. aztecus* exhibited decreased food-conversion efficiency and growth when the dietary protein (pure fish protein plus commercial trout chow) increased beyond the 40% level. The diets offered by VENKATARAMIAH and co-authors consisted of live food or dry pellets containing 40, 50, 60, 70 or 80% protein. Pellet fat content was adjusted with peanut oil to 4.5% and minerals to 5.5% as in the controls. Vegetable content was adjusted with dehydrated, finely-ground turnip greens.

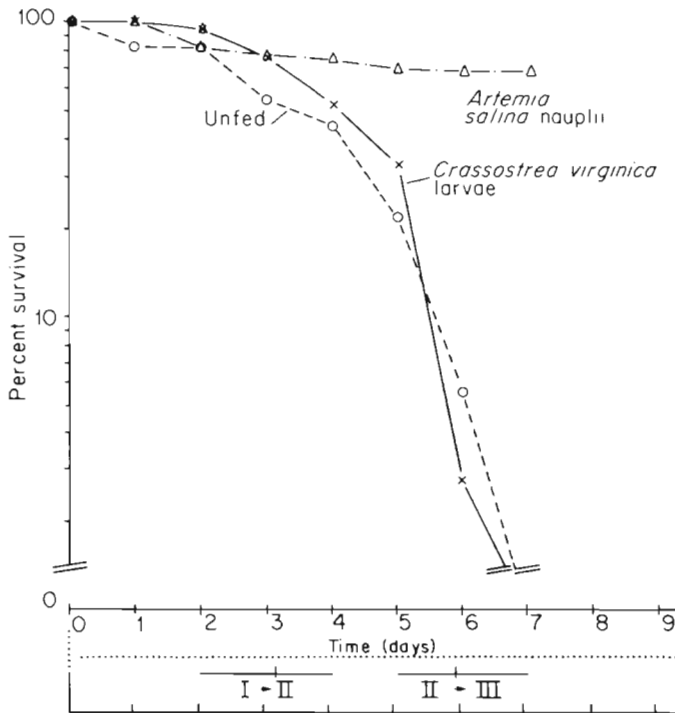

Fig. 5-55: *Pagurus longicarpus*. Survival of zoeae fed shelled larvae of the oyster *Crassostrea virginica* and nauplii of *Artemia salina*; a third group remained unfed. Bottom bars: time of moulting between the developmental stages indicated when fed *A. salina*. 18° to 22° C; 18 to 20‰ S. (After ROBERTS, 1974; modified; reproduced by permission of the *Biological Bulletin*.)

Other ingredients consisted of carbohydrates, vitamin mix, fish solvents and a binder. High-protein pellets were prepared by combining pure fish protein with various proportions of commercial trout chow. Pure fish protein had 93% crude protein, 0.05% fat and no fibre content. Small shrimp (9.5 mm initial length) were provided food pellets at a rate of 24 mg day⁻¹ individual⁻¹, large shrimp (20.6 mm), 68 mg day⁻¹ individual⁻¹. In order to meet increasing nutritional needs of the growing shrimp, the initial daily feeding rates were increased from the second week onward at 15 or 10% week⁻¹. The results obtained are summarized in Table 5-58. Growth rates decrease protein levels increasing above 40% and with decreased vegetable contents.

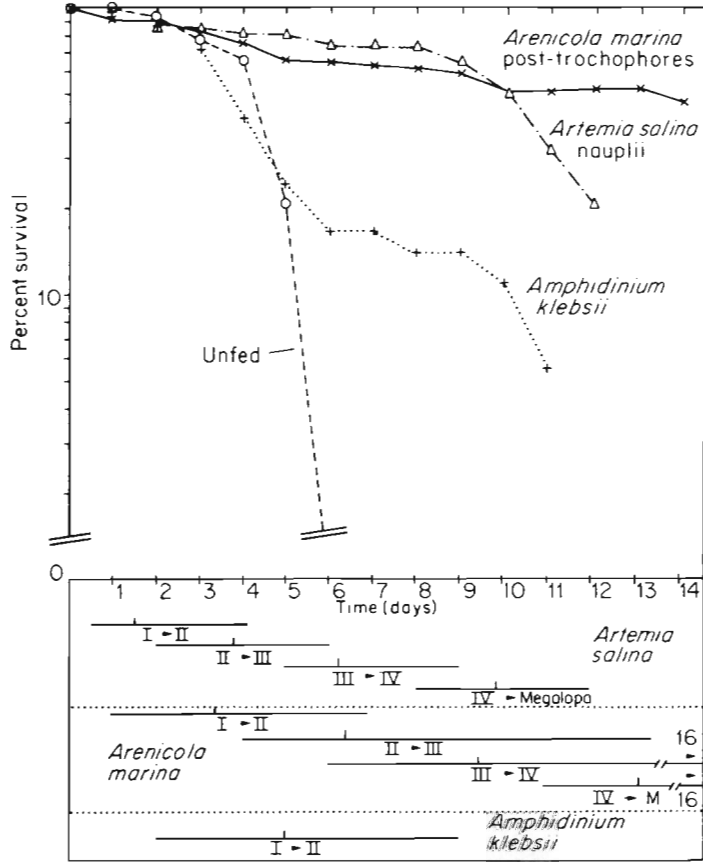

Fig. 5-56: *Pagurus longicarpus*. Survival of zoeae fed the dinoflagellate *Amphidinium klebsii* (contaminated with *Dunaliella* sp.), post-trochophores of *Arenicola marina* (carrying some *Nitzschia sigmoides*) and nauplii of *Artemia salina*; a fourth group remained unfed. Bottom bars: time of moulting between the stages indicated. 24° to 28° C; 22 to 23‰ S. (After ROBERTS, 1974; modified; reproduced by permission of the *Biological Bulletin*.)

Amino acids

The amino-acid requirements of decapods seem to be basically the same as in other arthropods, indicating a certain amount of uniformity. COWEY and FORSTER (1971), for example, report typical arthropod amino-acid requirements for *Palaemon serratus*. This shrimp rapidly metabolizes (U-¹⁴C) acetate. Since radio-active carbon from injected (U-¹⁴C) acetate is not incorporated into the amino acids arginine, methionine, valine, threonine, isoleucine, leucine, lysine, histidine, phenylalanine and tryptophan of the tissue proteins, it is inferred that these compounds are indispensable dietary constituents for the shrimp. There is a rapid turn-over of glucosamine and chitin. Juvenile *P. serratus*, fed a compounded diet containing freeze-dried cod muscle (a high-quality protein), gained about 70% of the weight

accumulated by individuals which received fresh mantle tissue of *Mytilus edulis* (Table 5-59).

In *Penaeus japonicus*, additions of arginine and methionine to the diet promote growth (KITABAYASHI and co-authors, 1971a, c): maximum growth is obtained at 0.5% methionine and at 0.8% arginine; higher amounts of these amino acids do not accelerate, but may even hinder, growth. Squid-meal extract appears to support growth mainly due to its arginine content.

Table 5-58

Penaeus aztecus. Postlarvae fed on various experimental diets*. Photoperiod: 12 hrs light; 26° C; 9‰S (small postlarvae) or 16‰S (large postlarvae); 30 individuals in each condition; V: vegetable content (After VENKATARAMIAH and co-authors, 1975; modified; reproduced by permission of Elsevier Scientific Publishing Company)

Diet	Protein level (%)	Vegetable content (%)	Survival rates (%)	Increment (mean)		Food conversion†
				Length (mm)	Weight (g)	
Small postlarvae (9.5 mm; 24 mg mean weight)						
Live food	<i>Artemia salina</i> nauplii		87.0	40.9	1.21	—
Pellet	40	5.5	80.0	32.1	0.93	2.8
	50	3.5	76.6	31.1	0.76	3.5
	60	2.5	66.6	24.1	0.50	6.1
	70	1.4	66.6	15.3	0.25	13.3
Large postlarvae (20.6 mm; 135 mg mean weight)						
Pellet	40 (control)	5.5	93.3	23.9	0.40	6.3
	50	3.5	93.3	16.4	0.18	11.9
	60	2.5	76.7	14.1	0.16	19.0
	70	1.4	85.0	14.7	0.15	18.2
	80	0.0	3.0	—	—	‡
Pellet + V	40 (control)	5.5	96.7	21.4	0.35	7.3
	50 + V	5.5	96.7	17.9	0.28	8.1
	60 + V	5.5	86.7	18.1	0.27	8.6
	70 + V	5.5	96.7	17.2	0.19	12.0
	80 + V	5.5	15.0	13.8	0.13	‡

* All food pellets contained: minerals, 5.5%; fat, 4.5%; vitamin mix, 3%.

† Dry food consumed per live weight gained (g).

‡ Food conversion ratios were not calculated at 80% and 80% + V protein levels because of heavy mortality.

There is evidence that parallelism between the amino-acid composition of food and of the decapod concerned favours maximum growth rates. In the prawn *Penaeus japonicus*, for example, DESHIMARU and SHIGENO (1972) recorded maximum efficiencies of food conversion when the food had a chemical composition similar to that of the prawn. Meat of the short-necked clam *Venerupis philippinarum* has a composition of conjugated amino acids which is quite similar to that of the prawn's own meat (Table 5-60). The amino-acid composition of other food materials (Table 5-61) and test diets (Tables 5-62, 5-63) also indicates a relationship to feed

efficiency. Dietary predominance of fish meal has never yielded good results, probably because of basic-amino-acid deficiency. Squid meal represents an effective protein source; its amino-acid composition resembles that of short-necked clam and of *P. japonicus*; hence, squid meal ranks high as a dietary component of the prawn.

Twelve kinds of protein-containing raw materials were used by DESHIMARU and SHIGENO (1972): squid (*Ommastrephes pacifica*) meal, mysid-shrimp meal, brine-shrimp (*Artemia salina*) meal, petroleum yeast, marine yeast, fish meal, whale (*Physeter macrocephalus*, *Balaenoptera physalus*) meal, activated-sludge meal, gluten, soybean protein (Table 5-61) and casein. These materials were compounded in the range of 80 to 90% and combined with a vitamin mixture (Table 5-62, B) and a mineral-salt mixture (Table 5-62 C) to reach 100%. The resulting powdery product was then well mixed with equivalent amounts of water, squeezed out from a mincing machine into a thread-like shape (2 mm in diameter), and finally dried

Table 5-59

Palaemon serratus. Weight gain values and standard errors obtained on the test diets indicated (20°C; sea water) (After COWEY and FORSTER, 1971; reproduced by permission of Springer-Verlag)

Diet number	Principal protein source	Weight gain (%) relative to that obtained on mussel mantle
1	Casein (supplemented)	39.9 ± 5.8
2	Freeze-dried cod muscle	69.1 ± 5.8
3	Predigested freeze-dried cod muscle	75.6 ± 5.8
4	Gelatin	22.4 ± 5.3
5	Gelatin supplemented with tryptophan	26.8 ± 5.3
6	Zein	19.8 ± 5.3
7	Zein supplemented with lysine and tryptophan	22.5 ± 5.3

to less than 10% moisture content. Table 5-64 summarizes the results of the rearing experiments. While Diet 1 is the best, the slight inferiority of Diets 2 and 3 will not necessarily be significant in well-equipped intensive shrimp farms with no more than 2 annual crops—provided feed cost can be significantly reduced.

Minerals and vitamins

Little is known about the mineral and vitamin requirements of decapods. The nutritional requirements of *Penaeus japonicus* for phosphorus and calcium have been studied by KITABAYASHI and co-authors (1971a), who added known amounts of these substances to a mixture of 50% squid (*Ommastrephes sloani pacificus*) meal, 14% squid-meal extract, 14% squid-liver extract, 12% starch, 5% wheat flour and 4% vitamin mixture. Maximum growth was obtained with a diet containing 0.53% glucosamine at 1.04% phosphorus and 1.24% calcium. Lower and higher glucosamine concentrations retard growth, and larger amounts of phosphorus and calcium tend to inhibit growth and stain the exoskeleton greyish-white.

Table 5-60

Amino-acid composition of the prawn *Penaeus japonicus* and of the test diets consumed by the prawn (After DESHIMARU and SHIGENO, 1972; modified; reproduced by permission of Elsevier Scientific Publishing Company)

Amino acids	Prawn			Test diets						Short-necked clam		
	%†	Ratio‡	Ratio‡	Over 90%*		90% ~ 80%		80% ~ 60%		Below 60%		
				%	Ratio	%	Ratio	%	Ratio	%	Ratio	%
Aspartic acid	7.97	11.3	9.52	11.4	8.95	11.2	8.44	11.3	10.46	14.0	9.53	11.3
Threonine	2.98	4.2	4.26	5.1	4.07	5.1	3.66	4.9	4.41	5.9	4.07	4.8
Serine	3.04	4.3	4.17	5.0	3.91	4.9	3.58	4.8	4.18	5.6	4.03	4.8
Glutamic acid	11.66	16.6	13.79	16.5	13.11	16.4	12.10	16.2	13.30	17.8	13.87	16.5
Proline	2.57	3.7	3.67	4.4	3.60	4.5	3.06	4.1	3.51	4.7	2.97	3.5
Glycine	3.45	4.9	4.59	5.5	4.55	5.7	3.81	5.1	4.41	5.9	4.16	4.9
Alanine	4.07	5.8	4.84	5.8	4.47	5.6	4.11	5.5	4.56	6.1	4.57	5.4
Cystine	0.77	1.1	0.58	0.7	0.80	1.0	0.82	1.1	0.52	0.7	1.04	1.2
Valine	3.03	4.3	4.09	4.9	4.07	5.1	3.58	4.8	4.11	5.5	4.29	5.1
Methionine	1.98	2.8	1.67	2.0	0.96	1.2	2.02	2.7	0.75	1.0	2.19	2.6
Isoleucine	3.13	4.5	4.26	5.1	4.23	5.3	3.66	4.9	4.11	5.5	3.75	4.5
Leucine	5.49	7.8	6.60	7.9	7.19	9.0	5.97	8.0	6.42	8.6	6.43	7.6
Tyrosine	2.87	4.1	3.17	3.8	3.12	3.9	2.84	3.8	2.61	3.5	3.18	3.8
Phenylalanine	3.30	4.7	3.84	4.6	3.51	4.4	3.37	4.5	2.69	3.6	3.38	4.0
Lysine	5.78	8.2	6.18	7.4	5.59	7.0	5.90	7.9	4.71	6.3	7.52	8.9
Histidine	1.64	2.3	1.59	1.9	1.52	1.9	1.57	2.1	0.75	1.0	2.00	2.4
NH ₃	0.99	1.4	1.08	1.3	1.12	1.4	1.04	1.4	0.37	0.5	0.92	1.1
Arginine	5.57	7.9	5.76	6.9	5.19	6.5	5.23	7.0	2.84	3.8	6.30	7.5
Total	70.29	100	83.66	100	79.96	100	74.76	100	74.71	100	84.20	100

* Test diets graded by feed efficiency.

† Amount of amino acids in the residue after extraction from the diets with hot 80% EtOH.

‡ Composition-rate of each amino acid to total amount of amino acids in the residue.

Table 5-61

Amino-acid composition of food materials offered to *Penaeus japonicus* (After DESHIMARU and SHIGENO, 1972; reproduced by permission of Elsevier Scientific Publishing Company)

Amino acids	Squid meal		Mysid-shrimp meal		Brine-shrimp meal		Petroleum yeast		Marine yeast		Fish meal		Sperm-whale meal		Fin-back whale meal		Activated-sludge meal		Gluten		Soybean protein		
	%	Ratio†	%	Ratio	%	Ratio	%	Ratio	%	Ratio	%	Ratio	%	Ratio	%	Ratio	%	Ratio	%	Ratio	%	Ratio	
Aspartic acid	12.08	12.1	10.07	12.6	6.48	10.1	7.78	11.2	8.44	11.9	8.21	10.8	7.10	8.4	8.11	9.1	4.38	11.6	3.43	4.8	7.80	11.4	
Threonine	5.08	5.1	4.48	5.6	3.15	4.9	3.75	5.4	1.93	6.7	3.57	4.7	3.77	4.5	4.39	4.9	1.98	5.3	2.82	3.8	2.73	4.4	
Serine	4.75	4.8	4.22	5.3	3.80	5.2	3.42	4.9	1.89	6.5	3.76	4.9	3.50	4.2	3.80	4.2	1.78	4.7	3.49	4.9	3.55	5.2	
Glutamic acid	16.04	16.1	12.44	15.6	9.34	14.6	8.58	12.4	3.67	12.7	11.99	15.7	12.02	14.3	13.18	14.7	4.72	12.6	21.59	30.4	13.26	19.5	
Proline	3.78	3.8	3.22	4.0	2.99	4.7	3.08	4.4	1.06	3.7	3.75	4.9	5.52	6.6	4.58	5.1	1.95	5.2	0.34	8.9	3.52	5.1	
Glycine	4.94	5.0	3.88	4.9	3.13	4.9	3.58	5.2	1.42	4.9	5.03	6.6	6.09	7.3	5.44	6.1	2.01	5.3	4.39	6.2	2.91	4.3	
Alanine	5.01	5.0	4.49	5.7	3.32	5.2	4.02	6.7	1.61	5.6	4.89	6.4	5.43	6.5	5.92	6.6	2.44	6.5	2.58	3.6	2.94	4.4	
Cysteine	0.69	0.7	0.96	1.2	0.84	1.3	0.32	0.5	—	—	0.77	1.0	0.28	0.3	—	—	—	—	0.87	1.4	0.86	1.6	
Valine	4.33	4.4	4.21	5.3	3.39	5.3	4.38	6.3	1.67	5.8	3.49	4.6	4.86	5.8	4.82	5.4	2.44	—	2.96	4.2	2.84	4.6	
Methionine	2.84	2.9	2.49	3.1	1.48	2.3	1.09	1.6	0.41	1.4	2.51	3.3	1.64	2.0	2.39	2.7	0.97	2.6	1.00	1.4	0.89	1.3	
Isoleucine	4.83	4.9	0.40	0.5	3.24	5.1	3.80	5.5	1.90	6.6	3.56	4.7	3.24	3.8	4.58	5.1	2.09	5.7	2.12	3.0	3.18	4.3	
Leucine	7.61	7.7	5.88	7.3	5.5	8.6	5.82	8.4	2.63	9.3	6.06	7.9	7.64	9.1	8.18	9.1	3.07	8.2	4.42	6.2	5.12	7.2	
Tyrosine	3.78	3.8	3.62	4.5	2.94	4.6	2.60	3.8	0.86	3.0	2.90	3.8	3.28	3.9	3.80	4.3	1.44	3.8	2.96	4.2	2.38	3.1	
Phenylalanine	5.53	5.6	4.00	5.0	3.39	5.3	3.33	4.8	1.37	4.7	3.24	4.2	4.42	5.2	4.53	5.1	2.37	6.3	2.59	3.7	3.46	5.7	
Lysine	7.98	8.0	6.88	8.6	4.77	7.4	6.36	9.2	2.47	8.6	5.72	7.5	6.64	7.9	7.09	7.9	2.52	5.9	2.33	3.3	4.22	6.7	
Histidine	2.04	2.1	1.99	2.5	1.38	2.2	1.73	2.5	0.67	2.3	1.27	1.7	2.96	3.5	2.38	2.7	0.90	2.4	1.43	2.0	1.65	2.3	
-NH ₂	1.06	1.1	1.64	2.1	1.06	1.7	1.27	1.8	0.66	2.3	0.91	1.2	0.67	0.8	0.76	0.8	0.70	1.8	2.28	3.2	1.21	1.8	
Arginine	7.12	7.2	5.16	6.5	4.34	6.8	3.84	5.5	1.52	4.2	4.69	6.1	5.03	6.0	5.57	6.2	2.16	5.7	3.73	5.3	4.96	7.2	
Total in residue	99.49	—	79.94	—	64.04	—	69.30	—	25.98	—	76.32	—	84.09	—	89.02	—	37.62	—	70.93	—	67.48	—	
Total in†																							
materials (g%)	74.91		55.32		39.58		52.11		19.24		64.11		26.90		74.48		34.20		31.92		31.92		48.92
Amino acids‡ (%)	92.00		72.80		72.76		85.10		75.20		90.90		79.60		90.50		83.40		36.80		36.80		97.10
Crude protein																							

* Amount of amino acid in residue, extracted with hot 80% EtOH from raw materials.

† Composition-rate of each amino acid to total amount of amino acid in residue.

‡ Total amino acid of protein in the materials, calculated from the formula:

$$\frac{\text{Total amino acid in residue part} \times \text{Percentage of residue part in material}}{100} \quad (\text{g}\%).$$

§ Rate of amino acid in the crude protein, calculated from the formula:

$$\frac{\text{Amount of amino acid in material} \times 100}{\text{Amount of crude protein in material}} \quad (\%).$$

Table 5-62

Gross composition (%) of test diets (A), composition of vitamin mixture (B), and composition of mineral-salt mixture (C) offered to *Penaeus japonicus*. (After DESHIMARU and SHIGENO, 1972; modified; reproduced by permission of Elsevier Scientific Publishing Company)

(A)

Component	Diet number		
	1	2	3
Squid meal	47.0	30.46	19.58
Mysid-shrimp meal	15.0	20.58	21.20
Petroleum yeast	20.0	20.98	20.98
Activated sludge	5.0	5.00	7.75
Gluten	3.0	3.00	3.00
Whale meal	—	10.60	12.71
Soy-bean protein	—	—	3.14
Fish meal	—	—	2.18
α -starch	2.0	1.38	1.46
Vitamin mixture*	3.0	3.00	3.00
Mineral-salt mixture†	5.0	5.00	5.00
Total	100.0	100.00	100.00

* (B).

† (C).

(B)

Vitamin	mg% in diet
Thiamine-hydrochloride	5
Riboflavin	40
Pyridoxine-hydrochloride	10
Cyanocobalamin	0.01
Nicotinic acid	75
Ca-pantothenate	50
Biotin	1
Inositol	200
Folic acid	3
Choline chloride	250
<i>p</i> -Aminobenzoic acid	40
Menadione	2.5
α -Tocopherol	25
Ascorbic acid (Ca-salt)	500
A (I.U.)	4000
D ₃ (I.U.)	250
Cholesterol	1250

(C)

Salt	Percentage
K ₂ HPO ₄	10
Ca ₃ (PO ₄) ₂	15
Ca-lactate	75
Total	100

P. japonicus grows well on a diet containing glucosamine hydrochloride, 0.4%; $\text{CaHPO}_4 \cdot 2\text{H}_2\text{O}$, 1.0%; and CaCO_3 , 2.5%. Glucose cannot be used as glucosamine source (KITABAYASHI and co-authors, 1971b), but is utilized for energy liberation, together with vitamin C (3.75% glucose; 0.22% vitamin C).

Analyses of the nutritional values to *Penaeus japonicus* of squid-liver oil and cholesterol (SHUDO and co-authors, 1971) revealed maximum growth at 4% squid-liver oil with 2% cholesterol (excess oil reduces growth). Cholesterol contents in the

Table 5-63

Amino-acid composition (%) of test diets offered to *Penaeus japonicus* (After DESHIMARU and SHIGENO, 1972; reproduced by permission of Elsevier Scientific Publishing Company)

Amino acid	Diet number		
	1	2	3
Aspartic acid	11.88	11.45	11.29
Threonine	5.21	5.21	5.12
Serine	4.87	4.82	4.83
Glutamic acid	15.47	15.19	15.30
Proline	4.07	4.28	4.47
Glycine	5.01	5.17	5.20
Alanine	5.44	5.73	5.80
Cystine	0.71	0.63	0.62
Valine	4.91	5.14	5.25
Methionine	2.60	2.58	2.49
Isoleucine	4.34	4.14	4.11
Leucine	7.73	7.93	7.99
Tyrosine	3.90	4.00	4.02
Phenylalanine	5.32	5.21	5.15
Lysine	8.17	8.20	8.05
Histidine	2.20	2.32	2.35
NH_3	1.41	1.44	1.49
Arginine	6.67	6.47	6.40
Total amount of amino acid in the protein (%)	52.25	51.55	50.63

Composition-rate calculation based on Table 5-61.

diet between 0.1% and 0.2% promote growth with a maximum effect at 0.1%. The nutritional value of cholesterol is slightly lower than that of squid-liver oil.

DESHIMARU and KUROKI (1974a) reaffirmed that cholesterol fortifies growth in *Penaeus japonicus* and suggest that this vitamin be compounded in the diet as an indispensable ingredient. They obtained maximum growth at a cholesterol concentration of 2.1%. Glucosamine, which had previously been reported to accelerate growth (see above), failed to promote growth in their experiments. According to DESHIMARU and KUROKI (1974b), the basal composition of the diet for *P. japonicus* should consist of: casein, 54%; mineral mixture, 19.5%; other ingredients, 8.5%; glycogen, 6%; egg albumin, 6%; cod-liver oil, 3%; soy-bean oil, 3%.

Pelleted Dry Foods and Binders

Studies with the aim of developing pelleted dry foods for decapods have been made by FORSTER and BEARD (1969), FORSTER (1970), COWEY and FORSTER (1971), VENKATARAMIAH (1971), SICK and co-authors (1972), JONES and co-authors (in press) and others. Of major importance in pelleted-dry-food design are a proper binder (see below), pellet size, shape, surface texture and, possibly, colour. FORSTER and BEARD (1973) offered experimental diets, finely milled in a ball mill and bound into jellies (using gelatin or agar) dissolved in water. None of the compounded diets supported growth as well as fresh foods such as mantle tissue of *Mytilus edulis*, tail meat of *Crangon crangon*, or gonad and digestive gland of *Carcinus maenas*. Addition of extra lipids (corn oil or cod-liver oil) or a vitamin premix to the compounded diets conferred no advantage. Presumably, fresh foods contain a labile growth factor. Such assumption is supported by experiments in which mussel mantle was offered as a weekly supplement to compounded diets. This resulted

Table 5-64

Suitability of diets offered to *Penaeus japonicus* (After DESHIMARU and SHIGENO, 1972; reproduced by permission of Elsevier Scientific Publishing Company)

Diet No.	Number of prawn at start	Rearing period (days)	Average body weight (g)		Rate of daily feed intake (%)	Rate of daily growth (%)	Feed efficiency (%)	Rate of survival (%)
			Initial	Final				
1	150	60	5.31	15.71	2.38	1.82(100.0)*	76.55(100.0)*	98.33
2	150	60	5.25	14.16	2.65	1.66(91.0)	62.50(81.0)	97.66
3	150	60	5.34	13.96	2.52	1.61(88.4)	63.85(83.0)	99.66

* Ratio of diet No. 2 and No. 3 to diet No. 1.

in growth rates equal to those obtained on mussel mantle. The growth factor involved has not yet been identified.

The problem of providing a dry-food formula acceptable to *Penaeus aztecus* has been tackled by VENKATARAMIAH and co-authors (1973a). Following experiments on colour and flavour preferences of *P. aztecus*, a suitable binder (no details given) was developed that holds the food pellets intact under water for several days over a wide range of salinities and temperatures (12° to 33° C). The pellets are readily accepted by shrimp longer than 9 mm and are assumed to meet the complete nutritional requirements of *P. aztecus*.

SICK and co-authors (1972) compared different semi-defined pelleted diets (containing defined chemical ingredients plus one or more undefined natural products), various ratios of shrimp to fish meal, and protein hydrolysates—fed at 3 percentages of total biomass daily—for their ability to produce increase in growth in penaeid shrimps. Over a 3-month period, pellets without shrimp or fish meal were found to sustain the shrimp biomass, while pellets with the highest proportion of shrimp to fish meal with added vitamins produced a more than 60% increase in total biomass. Shrimp fed a combination of yeast, soy and casein hydrolysates

Table 5-65
Penaeus aztecus. Increase in biomass and survival rate obtained under optimum environmental conditions on 18 diets grouped into 4 categories (After Sick and co-authors, 1972; not copyrighted)

Component	Group-I diets			Group-II diets					Group-III diets					Group-IV diets				
	1	2	3	4	5	6	7	8	9	10	11	12	13	14	15	16	17	18
Casein (%)	50.2	50.2	50.2	—	28.5	—	8.0	28.5	23.5	—	—	—	—	—	8.0	8.0	8.0	—
Methionine (%)	1.0	1.0	1.0	—	—	—	—	—	—	—	—	—	—	—	—	—	—	—
Glycine (%)	0.1	0.1	—	—	—	—	—	—	—	—	—	—	—	—	—	—	—	—
Sodium glutamate (%)	0.2	0.2	—	—	—	—	—	—	—	—	—	—	—	—	—	—	—	—
Citric acid (%)	0.3	0.3	—	—	—	—	—	—	—	—	—	—	—	—	—	—	—	—
Succinic acid (%)	0.3	0.3	—	—	—	—	—	—	—	—	—	—	—	—	—	—	—	—
Mineral mix* (%)	5.0	—	—	—	—	—	—	—	—	—	—	—	—	—	—	—	—	—
Fat† (%)	8.0	8.0	8.0	—	8.0	8.0	—	8.0	—	8.0	8.0	8.0	8.0	—	8.0	8.0	8.0	—
Carbohydrate premix‡ (%)	20.5	20.5	20.5	—	—	—	—	—	—	—	—	—	—	—	—	—	—	—
Shrimp meal (%)	—	—	—	—	28.5	69.5	36.5	23.5	—	28.5	28.5	28.5	28.5	—	69.5	69.5	69.5	—
Anchovy meal (%)	—	—	—	—	28.5	8.0	28.5	23.5	—	28.5	28.5	28.5	28.5	—	8.0	8.0	8.0	—
Shrimp muscle (%)	—	—	—	—	—	—	—	15.0	—	—	—	—	—	—	—	—	—	—
Yeast protein hydrolysate§ (%)	—	—	—	—	—	—	—	—	—	24.5	—	—	8.1	—	—	—	—	—
Casein protein hydrolysate§ (%)	—	—	—	—	—	—	—	—	—	24.5	—	—	8.1	—	—	—	—	—
Soy protein hydrolysate§ (%)	—	—	—	—	—	—	—	—	—	—	24.5	—	8.1	—	—	—	—	—
Collagen (%)	4.0	4.0	4.0	—	4.0	4.0	4.0	10.0	—	8.0	8.0	8.0	8.0	—	4.0	4.0	4.0	—
Vitamin mix¶ (%)	2.5	2.5	2.5	—	2.5	2.5	2.5	2.5	—	2.5	2.5	2.5	2.5	—	2.5	2.5	2.5	—
Cellulose (%)	7.9	12.9	13.8	—	—	—	—	—	—	—	—	—	—	—	—	—	—	—
Daily feeding rate (% of biomass)	5	5	5	0	5	5	5	5	0	5	5	5	5	0	5	10	15	0
Duration (weeks)	5	11	11	11	11	11	11	11	11	6	6	6	6	6	6	6	6	6
Results obtained																		
Increase in biomass (%)	18	0	0	0	44	63	50	37	—	19	18	18	39	—	58	109	164	—
Survival rate (%)	80	80	80	0	90	100	90	80	0	90	80	80	90	27	80	90	90	26

* Contains K₂HPO₄, 30.0%; KCl, 9.4%; MgSO₄, 14.8%; CaHPO₄·2H₂O, 27.4%; FeCl₃, 1.4%; MnSO₄·7H₂O, 0.2%; CaCO₃, 16.8%.

† Contains corn oil, 33.3%; hydrolyzed vegetable and animal fat, 33.3%; menhaden oil, 33.3%.

‡ Contains corn starch, 24.3%; sucrose, 24.3%; glucose, 24.3%; chitin, 19.5%; glucosamine, 7.6%.

§ Nutritional Biochemical Co. enzymatic hydrolysates.

¶ Nutritional Biochemical Co., Cleveland, Ohio, standard vitamin diet fortification mixture in dextrose.

increased 39% in biomass; those fed each of the hydrolysates separately yielded an average increase of 18%. Feeding a fish-shrimp base with added vitamins, at a rate of 15% daily of the total biomass, produced a 164% increase in weight with 95 to 100% survival. With semi-defined pelleted diets, a food-conversion efficiency of 5.5 was obtained. Defined environmental and nutritional culture conditions resulted in reproducible biomass production with high survival and acceptable food-conversion rates. A cheap and readily available substitute for shrimp-fish meals still remains to be found.

Triplicate groups of ten 4-g *Penaeus aztecus* were fed a series of pelleted diets (Table 5-65). Group-I diets contained only chemical ingredients; Group-II diets, chemical ingredients plus one or more natural products, providing 4 combinations of different levels of protein, fat, shrimp meal and fish meal. Group-III diets were designed to compare the nutritional values of casein, yeast and soy hydrolysates. All diet groups were fed at 5% of the respective biomass daily; in addition, Diet 6 was offered at 5, 10 and 15% of biomass (Group-IV diets). *P. aztecus* were kept under optimum environmental conditions, a population density of about 40 g m⁻², in aerated bare-bottom fibre-glass tanks. Table 5-65 reveals that semipurified diets with casein as major protein source (Group I) produce an average increase in biomass, above stocked biomass levels, of only about 18%. Fish and shrimp meal as additional sources of protein (Group II) produce approximately 63% increase on the best diet. Diets of hydrolyzed proteins (Group III) yield only 39% increase on the best diet. Shrimp fed at a rate of 15% of their total biomass (Group IV) increase this initial biomass by 164%.

A detailed analysis of the information obtained by SICK and co-authors (1972) reveals that, in Group I, Diet 1 with an added mineral mix yields a significantly higher biomass increase above initial weights at the 5% feeding level than either Diets 2 or 3 which lacked the mix. Diet 3 lacked sodium glutamate, glycine, citric acid and succinic acid in addition to the mineral mix, and caused a loss in biomass. As SICK and co-authors pointed out, these sustenance biomass levels are much lower than the 72% obtained by KANAZAWA and co-authors (1970); they may be due to the absence of cholesterol (many crustaceans are not able to synthesize cholesterol; e.g. KANAZAWA and co-authors, 1971). In Group II, Diets 5, 6 and 7 yielded increases which are not significantly different; total biomass gain decreases with the percentage of shrimp meal. In Group III, combinations of casein, soy and yeast hydrolysates produce better growth than individual hydrolysates; apparently, hydrolyzed proteins are not utilized more efficiently than intact proteins. Group IV indicates that, within a certain range, growth is directly proportional to an increase in feeding rate. Food conversion amounts to 6.7 at 10% biomass feeding, and 5.5 at 15%. These values are significantly lower than those reported for shrimp fed on natural foods (FUJINAGA, 1963).

Several investigators have examined possible binders for pelleted decapod diets. The main problem is to develop a binder that combines the right degree of compacting and water stability. Insufficiently-compacted and insufficiently-bound food matter comes apart too readily and thus may foul the culture water. On the other hand, too heavily-compacted and too rigidly-bound food may resist the pick-apart feeding mechanism exhibited by many decapods. In contrast to some fishes (e.g. trout) which quickly catch the food pellets as they enter the water, most decapods

are slow, sloppy feeders. Prior to ingestion, they manipulate the food with their feeding appendages. Unless the pellets are well bound, they disintegrate during examination and feeding, and their contents are swept away by exhalant gill currents. In order to prevent waste of nutrient materials and pollution of culture water, decapod food pellets must have a higher stability than fish pellets.

The binding properties and water stability of a number of compounds have been tested by FORSTER (1972) who found the following materials satisfactory when used to bind dry meal diets: (i) Jellies: agar (3.0% dry w/w). The binding agent was completely dissolved in water by heating in a boiling water bath. Thereafter, the hot solution was added to the test diet and stirred vigorously. The mixture was then poured into a 2.3-cm-diameter cylindrical mould and left to cool overnight at 5°C; sections 1 cm long of moulded jellies were cut and used for water-stability tests. (ii) Pastes: XB-23 (2.5% w/w); carboxymethyl cellulose (2.5% w/w). The binding agents were dry mixed with the test diet in a ball mill for 10 mins; water was then

Table 5-66

Binding properties of collagen for pelleted shrimp food. Given are percentages (means and standard deviations of two replicates) of pellets dissolved at three concentrations of binder after 6, 12 or 24 hrs. Pellets contain Diet 1 of Table 5-65 (After SICK and co-authors, 1972; not copyrighted)

Percent binder (collagen) added	Time (hrs)		
	6	12	24
1			
3	13 ± 1.2	14 ± 0.9	18 ± 1.7
5	11 ± 0.8	10 ± 0.6	10 ± 0.6
10	10 ± 0.6	10 ± 1.1	10 ± 1.0

added until a firm paste was produced. (iii) Dry pellets; polyvinyl alcohol (2.0% w/w); Manucol EA/LH (2.0% w/w); XB-23 (2.0% w/w); casein (4.0% w/w). The binding agents were either dry mixed with the test diet in a ball mill before adding water, or dissolved in water first and then this solution mixed with the test diet. The resulting pastes were forced through a domestic mincing machine. The 'worms' thus produced were cut into pellets and oven-dried at 65°C. A standard diet was used for all tests. None of the binding materials seriously affected the efficiency of nitrogen assimilation. A jellied (agar-bound) diet gave faster growth than the pastes, and these, in turn, were better than the dry pellets.

Other binders, such as alginates (MEYERS, 1971; MEYERS and co-authors, 1972) and collagen (SICK and co-authors, 1972, 1973), were also found suitable. A food pellet with 5% collagen provided optimum consistency (dissolution resistance, texture affinity) over a 24-hr period of immersion in sea water (Table 5-66). Percentage dissolution was measured by determining dry weights after 6, 12 and 24 hrs of immersion. Since no shattering was observed, all weight-loss was attributed to dissolution. Brown shrimp *Penaeus aztecus* fed most readily on pellets of

0.3-cm diameter and 1.5-cm length. DESHIMARU and SHIGENO (1972) also offered pelleted foods (no details on binders given) to *P. japonicus*. Their pellets were designed to keep their shape and to maintain moderate softness for more than 12 hrs in sea water of 23° to 28° C.

An inexpensive method for preparing water-stable diets that can be used for feeding experiments on aquatic crustaceans has been described by BALAZS (1973). Fed to marine (*Penaeus japonicus*) and limnic (*Macrobrachium rosenbergii*) natan-tians, the diets produced a 106 to 329% increase in weight in juveniles over a 25-day period. For further details on encapsulation of particulate or liquid food materials consult p. 1373.

Table 5-67

Penaeus aztecus. Initial and final food rations (dry-food-formula pellets) as a function of shrimp biomass (After VENKATARAMIAH and co-authors, 1973a, b; reproduced by permission of World Mariculture Society)

Feed Level	Percentage of Food Related to Shrimp Biomass	
	Initial	Final
A	20	4.5 ± 0.3*
B	30	5.9 ± 0.6
C	40	7.7 ± 0.8
D	70 (approx.)	10.5 ± 0.9

* ± values represent food-ration variations in the four salinities.

Food Ration and Conversion Efficiency

The food ration, i.e. the food allowance per unit time, usually per day, may significantly affect growth rates, activity pattern and food-conversion efficiency. Food-ration effects in penaeid shrimps have been studied, for example, by HUDINAGA and MIYAMURA (1962), COOK and MURPHY (1969), SUBRAHMANYAM and OPPENHEIMER (1969, 1970), VENKATARAMIAH and co-authors (1973a, b), MOCK (1974), HIRATA and co-authors (1975) and EMMERSON (in press). The results presented thus far do not allow definite conclusions. Practically all studies were aimed at producing maximum growth. Ecologically oriented studies on food rations, i.e., investigations into quantitative aspects of normal feeding, have yet to be conducted. Food rations producing maximum growth are a function of temperature, salinity and diet.

At 26° C, VENKATARAMIAH and co-authors (1973a, b) determined food-conversion efficiency of 17- to 35-mm long *Penaeus aztecus* exposed to 25, 50, 75 and 100% sea water (100% sea water = 34‰S). Four different rations were offered, the amounts corresponding to 20, 30, 40 or ca 70% of the shrimps' biomass; the four rations were designated as A, B, C and D. Starting from the second week, initial food rations were

increased once a week. The initial and final feed rations, as a function of initial and final shrimp biomass, are listed in Table 5-67. Mean length increase of *P. aztecus* obtained on four rations in four salinities (Fig. 5-57), reveals best growth in 50% sea water, and lowest growth in 100% sea water. The highest daily length increase, 1 mm day⁻¹, occurred in 50% and 25% sea water, respectively. Within the 6-week experimental period, 640 individuals (postlarvae or juveniles) with a combined weight of 102 g were grown to a final weight of 887 g. The greatest weight increase (all rations) was obtained in 25% sea water (210 g), followed by 50% sea water (192 g), and 75% sea water (177 g). The highest average absolute weight increase per shrimp was 1234 mg in 50% sea water; the lowest, 1139 mg in 75% sea water.

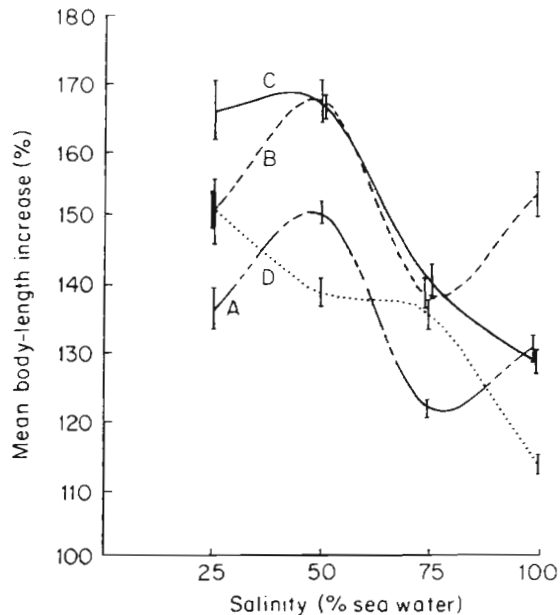

Fig. 5-57: *Penaeus aztecus*. Mean body-length increase (%) obtained on 4 rations (A, B, C, D, see Table 5-67). Photoperiod: 14 hrs light; 26° C; 4 salinities. (After VENKATARAMIAH and co-authors, 1973a; modified; reproduced by permission of World Mariculture Society.)

Food-conversion efficiencies vary with environmental conditions (Volume I: KINNE, 1970, 1971; Volume II: PANDIAN, 1975) and with the diets offered. The sometimes widely differing conversion efficiencies recorded in decapods suggest that optimization of environmental conditions, feeding schedule, diet composition and stock improvement may significantly enhance the transformation efficiency of food into body-own substances.

Energy transformation in cultivated *Lucifer chacei* larvae and adults (ZIMMERMAN, 1973) revealed that protozoa, zoea and schizopod stages assimilated 10.1% and 10.4%, respectively, of ingested *Dunaliella tertiolecta*. Adults assimilated 7.7% of ingested *D. tertiolecta*, and about 22% of ingested *Artemia salina* nauplii.

ZIMMERMAN's data indicate a change from herbivorous larvae to omnivorous adults: older stages cannot apparently obtain sufficient energy from phytoplankton alone to support growth and activity.

In larvae of the stone crab *Menippe mercenaria*, MOOTZ and EPIFANIO (1974) measured food intake (C), growth of new body tissue (P_g), exuvia (E) and respiration (R). Egestion (F) and excretion (U) are considered together as rejecta (FU) and obtained by subtraction (Table 5-68). Stone-crab larvae grow exponentially through the zoeal stages; in the megalopa, growth rate decreases while food consumption

Table 5-68

Menippe mercenaria. Energy budget and energetic efficiencies for each cultured zoeal stage and the megalopa. Food and environment as in legend to Fig. 5-58. A : digested material which is assimilated (After MOOTZ and EPIFANIO, 1974; modified; reproduced by permission of Biological Bulletin)

Energy budget

Stage	Energy consumed (C) (cal)	Growth (P_g) (cal)	Energy of exuvia (E) (cal)	Respiratory energy expenditure (R) (cal)	Rejecta (FU) (cal by diff.)
1	0.211	0.025	0.003	0.060	0.123
2	0.347	0.054	0.005	0.082	0.208
3	0.376	0.085	0.006	0.093	0.192
4	0.838	0.192	0.030	0.188	0.428
5	1.590	0.671	0.057	0.404	0.458
Megalopa	3.980	1.181	0.402	1.105	1.292

Energetic efficiencies

Stage	Percent assimilation (A/C)	Gross growth efficiency (P_g/C)	Net growth efficiency (P_g/A)
1	41.70	11.84	28.41
2	40.40	15.56	38.30
3	48.91	22.61	46.19
4	48.93	22.91	46.83
5	71.19	42.20	59.93
Megalopa	85.43	29.67	43.94

attains its maximum: 1 megalopa may take up 91 *A. salina* nauplii day⁻¹. Feeding rate (Fig. 5-58) decreases prior to moulting to the first crab. During larval development, 7.329 cal are consumed; 2.207 cal are used for growth; 0.502 cal are lost to exuvial production; 1.933 cal are expended for maintenance; and 2.687 cal are lost as excreta. Respiration by zoeae is proportional to the two thirds power of body weight. The calorific content per unit dry weight increases from 2.503 cal mg⁻¹ at hatching to 3.746 cal mg⁻¹ at first juvenile crab stage. Exuviae contain 1.296 cal mg⁻¹.

In the search for proper mass-culture diets, the following points are of importance: (i) knowledge on the nutritional requirements of the species involved, including

possible variations as a function of environmental conditions, life-cycle stage, or physiological state; (ii) sufficient reproducibility of diet quality; (iii) ready availability of inexpensive raw materials, e.g. trash remains of plant matter and of molluscs, crustaceans and fishes; (iv) addition of vitamins and, if necessary, minerals according to specific requirements; (v) development of pelleted food and of a binder that accounts for the 'hold-and-pick-apart' feeding habits of natantians and reptantians (important: water stability, attractiveness of pellet coat; long shelf life); (vi) where necessary, supplementation of dry foods by minimum requirements for living (fresh) foods.

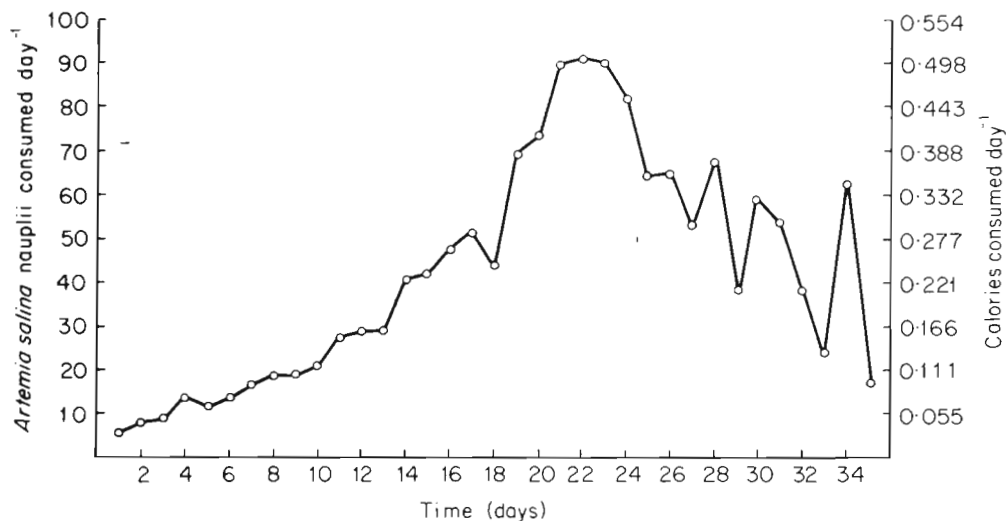

Fig. 5-58: *Menippe mercenaria*. Feeding rates of cultured larvae. Food: 5 *Artemia salina* nauplii ml⁻¹. Photoperiod: 12 hrs light; 25° C; 30‰S. (After MOOTZ and EPIFANIO, 1974; modified; reproduced by permission of the *Biological Bulletin*.)

Decapoda Natantia (Shrimps and Prawns)

Although Natantia species known as shrimps are often smaller than those referred to as prawns, these two common names are not strictly separate and are occasionally used interchangeably. Natantia inhabit marine, brackish and fresh waters—sometimes migrating from one to the other. They often establish large populations with high individual densities. For thousands of years, shrimps and prawns have been praised by gourmets. No wonder, then, that these animals have received, and still attract, much attention from ecologists and mariculturists. Thus far, about 45 Natantia species have been sustained under laboratory or pond conditions.

Pioneered and refined in Japan, modern shrimp and prawn mass-culture techniques are now being used and improved also in other countries, especially in the USA. While most of the mass-cultured Natantia find best conditions for growth and reproduction in tropical and subtropical countries, experimental and farming projects have recently been initiated also in temperate zones, especially in areas

where protection from critically low temperatures is relatively easy or where waste heat is readily available. Commercial cultivation of malacostracans and of other marine animals receives special attention in Chapter 5.2.

Alpheus Species

Belonging to the family Alpheidae (Crangonidae), the snapping-shrimp genus *Alpheus* (syn.: *Crangon*) has asymmetrical chelae on the first pair of pereiopods. Captive larvae of *Alpheus armillatus* and *A. normanni* did not live through more than 3 moults even though they were offered a variety of foods and kept under a variety of culture conditions (KNOWLTON, unpublished). Only *Alpheus* species with abbreviated larval development have been reared successfully under laboratory conditions. Larvae of *A. heterochaelis*, for example, usually moult only 3 times (HERRICK, 1888; BROOKS and HERRICK, 1892; KNOWLTON, 1970, 1971, 1972, 1973). They hatch as large (4.6 mm), advanced zoeae and metamorphose after 4 days at 25° C. Stage I lasts 6 hrs at most and is sometimes omitted; Stage II is about half as long as III. The first chelae do not become asymmetrical until 2 months after metamorphosis. The abbreviated development of *A. heterochaelis* is unique within the genus.

KNOWLTON (1973) maintained newly collected, ovigerous females of *Alpheus heterochaelis* in the laboratory, in isolation, at about 25° C in large finger bowls containing unfiltered habitat water of about 30‰S. The shrimps were transferred to finger bowls with new water once a week, usually following feeding, but never immediately after a moult. Most individuals were fed pieces of clam foot. *A. heterochaelis* accepts other foods such as fish muscle, *Artemia salina* nauplii or frozen shrimp and, apparently, can exist on plankton or detritus alone. Zoeae were pipetted into individual culture vessels (small Stender dishes of clear glass with ground lids, or square boxes of clear styrene plastic) containing unfiltered or Millipore-filtered habitat water (total volume per vessel: 20 cm³). KNOWLTON rinsed all equipment used first in tap water and then 'conditioned' it in habitat water prior to introducing the larvae. Every second day, each larva was transferred to a vessel with new water and a new food supply (daylight and overhead lights, natural photoperiod; 24.6° to 27.6° C; 31 to 36‰S). No external food seems to be required during the short larval development. Optimum temperature-salinity conditions for larval survival were 25° to 30° C and 25 to 30‰S.

Crangon Species

Crangon crangon, the common sand shrimp, inhabits coastal areas on both sides of the North Atlantic Ocean, as well as on the European Mediterranean Sea, North Sea and Baltic Sea. Its development has been studied by EHRENBAUM (1890), WILLIAMSON (1901), MEYER-WAARDEN (1935a, b) and TIEWS (1954); reproductive activities by MEYER-WAARDEN (1935a), NOUVEL (1939) and TIEWS (1954); food requirements by PLAGMANN (1939); feeding behaviour by DAHM (1975); migratory behaviour by BROEKEMA (1941) and VERWEY (1958).

The first attempts to cultivate *Crangon crangon* were undertaken by TIEWS

(1954). MEIXNER (1966) succeeded in rearing larvae and postlarvae beyond metamorphosis to sexual maturity. He kept newly collected zoeae in glass dishes of 7.5-cm diameter and 11.5-cm height, juveniles in dishes of 11 × 19 cm, and adults in dishes of 17 × 26 cm (45 lux from fluorescent tubes; photoperiod: 10 hrs light; 14° C; 30‰S). The culture water was not aerated, but renewed twice a week. The larvae received freshly hatched nauplii of *Artemia salina* as food; later stages were fed adult *A. salina*. For mass cultures, an important problem to be solved is the provision of suitable, cheap and readily available food. Since *C. crangon* is still caught in considerable quantities at sea, it will be difficult to farm this shrimp at a competitive market price. A synopsis of biological data has been compiled by TIEWS (1970).

Crangon septemspinosa has been cultivated from metamorphosis to sexual maturity at 20° C (REGNAULT, 1970). Final size and moulting frequency are affected by the quantity of food available. Within a rather wide range, salinity exerted little effect on growth.

Leander squilla

This palaemonid shrimp has been cultivated in 50-l sea-water aquaria with inside sand filters (Chapter 2), as well as in large tanks of 500-l capacity (SCHULTE, in press). Studies conducted at different temperature levels between 5° and 30° C, revealed 25° C to be close to the thermal optimum. Artificial egg incubation yielded hatching rates near 5%. A minimum of 6 and a maximum of 11 larval moults were necessary for attaining the first post-larval stage. At 20° C, the entire life cycle lasted about 7 months.

Macrobrachium Species

The euryhaline, evolutionarily highly successful palaemonid genus *Macrobrachium* is of special interest to experimental ecologists concerned with organismic responses to salinity variations and to aquaculturists. Of the well over 100 *Macrobrachium* species known, most inhabit fresh and/or brackish waters of the warmer continents. Only one species—*M. intermedium*—has been reported (HOLTHUIS, 1952b) to be fully marine, i.e. to spend its entire life cycle in the sea. The large number of larval stages and the apparently specific environmental and nutritional requirements of the larvae make egg-to-egg breeding a difficult task. Adults copulate and spawn readily under laboratory conditions, and incubation and hatching pose no problems. The growth rates of juveniles thus far recorded are moderate. While economic mass cultivation of *Macrobrachium* species has not yet been achieved, pilot farms are being operated with several species and are reporting promising results.

Macrobrachium acanthurus exhibits a distribution similar to that of *M. carcinus* (see below), but is somewhat smaller in size. Employing comparable methods as in *M. carcinus*, CHOUDHURY (1970, 1971c) reared larvae of *M. acanthurus* at 23° to 27° C (pH 6.5 to 8.0) in 15‰ to 20‰S (in fresh water they die within 8 days). The juvenile stage was reached 25 to 40 days after hatching. Nearly 9% of the larvae survived metamorphosis to the juvenile stage. The 10 larval stages and 3 juvenile stages of *M. acanthurus* have been described by CHOUDHURY (1970).

Macrobrachium americanum has been cultivated in a Mexican aquaculture unit on a balanced diet used for poultry, supplemented by ground fish meat (ARANA, 1974).

Macrobrachium australiense, collected by dragging hand nets through inshore vegetation, were transferred by FIELDER (1970) to small aquaria filled with river water. Larvae released from ovigerous females were transferred separately in glass pin-trays containing about 100 ml of river water which was replaced with fresh, unfiltered river water each day (no aeration; between 21° and 28° C). While the larvae of *M. carcinus*, *M. acanthurus* and *M. rosenbergii* require brackish water for successful development, the larvae of *M. australiense* develop in fresh water; they did not appear to feed at any stage. FIELDER could not observe differences in growth rates between fed (nauplii of *Artemia salina*, desiccated liver) and unfed larvae. The period between hatching and metamorphosis seldom exceeded 6 days. Females of 8–12-cm carapace length carry from about 100 to 200 eggs. There are about 3 larval stages; the first zoea stage rarely lasts longer than 24 hrs; the second zoea usually lasts 2 days; the third zoea, 3 to 4 days.

Macrobrachium carcinus, a rather large shrimp (up to 23 cm), inhabits fresh and brackish waters of eastern America, from Florida to southern Brazil, and in the West Indies. In Jamaica, *M. carcinus* occurs occasionally in freshwater rivers and is caught during the rainy season (HOLTHUIS, 1952a, b). Reports on cultivation have been published by MERCADO (1959), INGLE and ELDRED (1960), LEWIS (1961), LEWIS and WARD (1965) and CHOUDHURY (1971a, b). CHOUDHURY (1971a) reared *M. carcinus* from hatching through metamorphosis. He transported freshly caught berried females in large, heavily-aerated plastic containers to the laboratory, where the females were each transferred into an aerated aquarium (60 × 30 × 30 cm deep) containing fresh water. The shrimp received chopped fish once a day. Hatching always occurred during the early night hours. Aggregated by light, the larvae were siphoned slowly to salinities of 14‰ to 16‰S (moderately-aerated aquaria of 40 × 30 × 30 cm) and reared to juveniles (24° to 28° C, pH 7.0 to 8.5). Larval development was not successful in salinities lower or higher than 14‰ to 16‰S. The larvae received nauplii of *Artemia salina* and pieces of muscle from fishes and crustaceans as food. They also consumed detritus and food prepared from boiled beans, carrots, cabbages, rice and corn (CHOUDHURY, 1971b). There are 12 larval stages; attainment of the juvenile stage takes 56 to 66 days. For larval responses to salinity and diet consult CHOUDHURY (1971b).

Macrobrachium intermedium, a marine species from Australia, and *M. niloticum*, a limnic species from Africa, have 8 to 10 zoeal stages. Both have been reared from egg to postlarva by WILLIAMSON (1972). An ovigerous female of *M. intermedium* was placed in a Perspex cylinder, with gauze over the lower end, in an aquarium with running sea water (ca 18° C). The apparatus used is illustrated in Fig. 2-154 (p. 241). After hatching, the larvae were fed a fresh supply of *Artemia salina* nauplii every second day. Mortality was low until Stage VI, when cannibalism became a serious problem. Only 12 larvae reached Stage VIII, the last stage obtained. WILLIAMSON assumes that there would have been about 2 more zoeal stages before metamorphosis. Presumably *A. salina* nauplii alone were insufficient as food source for the larvae. The larval development of *M. olfersii* has been studied by DURWOOD and DOBKIN (1975).

Macrobrachium rosenbergii, the giant prawn of the Indo-Pacific region, inhabits brackish and fresh waters. Developing larvae require salinities between 8‰ and 20‰. Copulation occurs a few hours after the female's premating moult and results in sperm attachment to the ventral side of her thorax legs. Oviposition takes place within 6 to 20 hrs after copulation. At 26° to 28° C, incubation lasts about 19 days. LING and MERICAN (1961) and LING (1962) have reared larvae of *M. rosenbergii* to the juvenile stage and maintained adults. Between 14‰ and 17.5‰S, 16% to 17% of the larvae survived metamorphosis and the length of the larval period was similar to that of *M. acanthurus* (p. 842). Males reach a maximum length of about 25 cm, females of about 15 cm. Commercial cultivation has not yet been attempted on a large scale, but seems feasible (LING, 1969a, b).

In a closed sea-water system, WICKINS and BEARD (1974) observed *Macrobrachium rosenbergii* for 390 days (artificial illumination; 28° C; 5‰S; biological filter). The prawns mated readily in the experimental tanks (48 × 28 × 25 cm deep). Three females produced eggs more than 4 times in successive intermoult periods, and 1 produced viable larvae 5 times in succession. Egg incubation lasted 20 days. The mean number of larvae obtained per brood was 24,000 (range: 50 to 98,100). As in other crustaceans, brood size increases with female size. From 7 broods, WICKINS and BEARD raised the larvae to the post-larval stage.

In their natural habitat, females of *Macrobrachium rosenbergii* presumably spawn 3 to 4 times a year and produce up to 150,000 eggs at each oviposition. The large number of relatively small eggs (long axis: 0.7 mm), the long larval life and the salinity requirements of the larvae indicate close ties to the marine environment. River-hatched larvae are quickly transported downstream to suitable salinities. During this process, the large larval aggregations, which form immediately after hatching, become dissipated. Within 35 to 55 days, the larvae pass through 12 stages and metamorphose to juveniles (LING, 1969a). The larvae prefer zooplankton as food, but also eat minute particles of dead plant or animal matter. The juveniles feed on benthic animals and detritus. Depending on temperature, juveniles moult at intervals of 4 to 6 days. They begin to migrate upstream and, after a migratory period of 2 to 3 months, the young prawns (5–6 cm long) reach fresh water. Now they eat voraciously almost any organic matter available—dead or alive—and often resort to cannibalism. Under favourable conditions, sexual maturity is attained after 9 months. Subsequently, both sexes begin their downstream spawning migration.

LING (1969b) collected *Macrobrachium rosenbergii* by trap, hook or hand net. He kept mature females in aerated 100- to 200-l tanks, and screened newly moulted individuals off from the rest. Since males tend to fight, they were maintained separately in 60-l tanks. Adult, mature females were ready for copulation 2 to 3 hrs after the moult; they oviposited about 24 hrs after copulation. For group spawning, 8 to 20 females were placed together with 2 to 4 males in a vigorously-aerated freshwater tank (3 × 1.5 × 0.4 m deep). Fertilized females were transferred individually to 50- to 200-l tanks. At 26° to 28° C, the originally bright orange colour of the eggs faded to a pale grey after about 12 days; from then on, small amounts of sea water were added daily. When the pale grey darkens to slate grey, hatching is imminent; by this time, the salinity should have reached 15‰ to 18‰S. One female produces an average of 50,000 larvae. The larvae can easily be light-trapped

and caught with a cup. They can be reared in tanks ($3 \times 0.7 \times 0.5$ m deep) with a water depth of 16 to 20 cm. While the larvae are quite resistant to minor differences in water quality, survival and growth were best at 26° to 28° C, 12‰ to 14‰S, pH 7.0 to 8.0 and near-saturation values of dissolved oxygen.

According to LING (1969b), overfeeding may result in a thus far incurable fungus infection (small white patches on tail and appendage bases); infected larvae must be removed and destroyed. Larvae may also suffer from undetermined protozoans; early stages of infection are treated with 0.2 ppm of malachite green for 30 mins daily, or with a single dose of 0.4 ppm copper sulphate for 6 hrs (KINNE (in press)). As in other pelagic larvae, stranding can be avoided by shading the sides of the tank and by concentrating incoming light in the tank centre; to prevent larvae from jumping out of the water, the tanks must be covered. When the larvae are ready to metamorphose, stones, shells and other materials should be placed on the bottom of the rearing tank to provide hiding places for moulting individuals. Juveniles can easily be acclimated to fresh water within 3 to 8 hrs by gradual water exchange.

LING (1969b) transferred juvenile *Macrobrachium rosenbergii* to larger tanks or ponds (5 to 50 m², 0.15 to 1 m deep). These were heavily aerated, received a continuous flow of new water, and contained abundant hiding places for young prawns. Stocking densities for juveniles varied from 2 to 10 m⁻². The main food items were pieces of fish, molluscs, earthworms and chironomid larvae. In addition, dried animal matter, soaked in fresh water for 30 mins before use, and pieces of plants (wheat grains, peas, beans, aquatic plants) were offered. LING employed 3 daylight feedings and 1 night feeding each day. The amounts of food must be dosed so as to avoid both cannibalism and fouling due to excess feeding. Under suitable conditions, juveniles attain lengths of 2 to 3 cm within 30 days (survival rate ca 50%). At about 4 cm length, the young prawns were transferred to production ponds (from 200 m² to over 1000 m² surface area, 0.5 to 1 m deep; 22° to 32° C). In general, large ponds are more economical. Marketable size (15 cm, 100 g) was reached in 5 to 6 months. *M. rosenbergii* is harvested by seining or draining the pond. Since *M. rosenbergii* production is still at the experimental stage, only few data are available on yields (FUJIMURA, 1966; BARDACH and co-authors, 1972). A commercial pilot operation on Oahu, Hawaii, produces 3000 kg ha⁻¹, and 4000 kg ha⁻¹ may be attainable (see also Chapter 5.2).

For commercial cultivation, *Macrobrachium rosenbergii* may be stocked alone or in combination with herbivorous or zooplankton-feeding fishes, such as the big-head carp *Aristichthys nobilis*, grass carp *Ctenopharyngodon idella*, milkfish *Chanos chanos*, silver carp *Hypophthalmichthys molitrix*, catla *Catla catla*, rohu *Labeo rohita*, grey mullet *Mugil cephalus*, kissing gourami *Helostoma temminckii*, sepat siam *Trichogaster pectoralis*, three-spot gourami *T. trichopterus*, *Osteochilus hasselti* and *Barbus gonionotus* (LING, 1967; see also BARDACH and co-authors, 1972). Suitable stocking densities depend on pond conditions (soil and water) and the fishes co-stocked (Table 5-69).

In production ponds, natural food satisfies most of the nutritional requirements. Productivity can be augmented by addition of 200 kg of cow dung and 10 kg of lime per hectare and month. Supplementary feeding consists of 75% animal matter (pieces of fish, molluscs, earthworms, offal, live insects and silkworm pupae) and 25% plant material (various grains and rotten fruits). Daily rates of supplementary

feeding amount to 5% of the total body weight of the prawns (2.5% in the morning; 2.5% in the afternoon). Accumulation of waste material is reduced by placing the food in trays mounted along the side of the pond. *Macrobrachium rosenbergii* is very sensitive to oxygen depletion (FUJIMURA, 1966). Details on a hatchery plan for *M. rosenbergii* (including pond and tank dimensions, aeration system, hatchery equipment, staff and hatchery building) have been presented by LING (1969a, b).

Of the other *Macrobrachium* species cultivated, *M. caementarius* has been raised in tanks in Peru and used for stocking natural waters. *M. rude* was cultivated (along with *M. rosenbergii*) in India. *M. malcolmsoni*, after stocking a freshwater pond in Pakistan with 15,000 juveniles, yielded 560 kg of adult prawns; controlled

Table 5-69

Macrobrachium rosenbergii. Stocking densities in production ponds for prawn and combined prawn-fish culture. The fishes listed on p. 845 serve as culture partners (Based on data by LING, 1967, 1969a, b)

Pond conditions	Stocking density of prawn culture (prawns ha ⁻¹)	Stocking density of combined prawn-fish culture (100% of fish)
	Prawns alone	
Rich	15,000	—
Medium	10,000	—
Poor	6,000	—
	Prawns and fishes	
Rich	6,000	100
	12,000	50
Medium	4,000	100
	8,000	50
Poor	2,000	100
	4,000	50

breeding was accomplished by confining pairs in fine-meshed cages (69 × 36 × 18 cm deep) at the side of the pond, and feeding with rice bran each morning (BARDACH and co-authors, 1972). The larval development of the limnic *M. formosense* has been studied by SHOKITA (1970).

Metapenaeus Species

Newly caught, gravid females of *Metapenaeus ensis* have been placed by ONG (1969) in a plastic container (80 × 60 × 60 cm deep) filled to a depth of 40 cm with well-aerated (2 air stones) non-running, unfiltered sea water (26° to 30° C; 30‰ S). Freshly hatched nauplii were scooped up with a bowl, and transferred to plastic containers about half-filled with gently aerated sea water. *M. ensis* has 4 naupliar stages, 3 protozoa and 3 mysis stages, followed by the postlarva (see also CHEUNG,

1964). The nauplii do not feed. Protozoa stages consumed copepods and diatoms available in the unfiltered sea water. In addition, small unidentified copepods and newly hatched *Artemia salina* were offered from the third instar onwards. The highest mortalities (no details given) occurred during the first protozoa stage (ONG, 1966a, b). This was also the case with other penaeids (HUDINAGA, 1942; DOBKIN, 1961; EWALD, 1965; RENFRO and COOK, 1963). Later larval stages require addition of suitable food organisms in sufficient densities.

Adult *Metapenaeus ensis* feed mainly on vegetable matter (HALL, 1962). Since they do not compete for food with the commercially more valuable *Penaeus monodon* or *P. merguensis* (which feed mainly on crustaceans and fishes), ONG (1969) suggests that *M. ensis* could be commercially cultivated together with these forms if large ponds impounded from suitable coastal areas are available.

Synopses of biological data on *Metapenaeus affinis*, *M. brevicornis*, *M. dobsoni* and *M. monoceros* have been presented by GEORGE (1970a, b, c, d). *M. affinis* and *M. dobsoni* are trapped in the extensive coastal rice fields of Kerala (southern India). They are caught after the autumn rice crop during low tides at night. A mature female of *M. dobsoni* spawned under laboratory conditions (27.8° C; 30.2‰ S). The larvae hatched but failed to develop (VEDAVYASA RAO and KATHIRVEL, 1973).

Palaemon Species

Palaemon serratus has been sustained under laboratory conditions by REEVE (1969a, b, c) and PHILLIPS (1971). While gonad maturation, copulation, spawning, egg-carriage, hatching and development of larvae and juveniles created no problems, difficulties were experienced in the long-term keeping of adults. Major reasons for this were cannibalism and microbial infection. The 'white spot' disease readily spread through a population; it caused progressive tissue breakdown from tail forwards and, finally, death (KINNE (in press)). Feeding deficiencies may have contributed to both extensive cannibalism and increased disease susceptibility. While growth was rarely observed in adult stocks, the prawns continued to moult regularly (21-day intervals at 20° C).

Larvae of *Palaemon serratus* were reared by REEVE (1969c) in containers with a capacity of less than 2 l (20° C, filtered sea water of 32.5‰ S) and fed nauplii of *Artemia salina*. Optimum temperature for survival, growth and metamorphosis ranged from 20° to 25° C. At maximum growth rates, the larvae metamorphosed within 3 weeks (about 7 larval stages). Larvae kept at 30° C did not survive metamorphosis, and those kept below 10° C, exhibited no significant growth. Salinity tolerance is considerable: 50% of the larvae survived direct transfer into salinities ranging from 15 to 45‰ for at least 4 days. A wide variety of food was offered to newly hatched larvae (4 mm length) ranging from coarse resuspensions of dried *Chlorella* sp. to chopped ox liver. The most satisfactory food—in regard to ease of preparation, tank maintenance, and growth and survival—was nauplii of *A. salina* (optimum concentration 5 to 10 larvae ml⁻¹). Growth of *P. serratus* was twice as fast as in nature due to high temperature and extensive feeding.

Considering the suitability of *Palaemon serratus* for commercial cultivation, REEVE (1969c) points out that while *P. serratus* produces fewer eggs (several thousand) than the penaeids (several hundred thousand), its eggs are carried by the

female (penaeids whirlpool their eggs into the water), the eggs are larger and the larvae hatch directly into predatory zoeae, eliminating the need for preparing phytoplankton food (required by freshly hatched penaeids). In view of pronounced genetical variation between broods, selection of fast-growing genetical strains (stock improvement) seems promising. Where warm-water effluents, e.g. of electricity-generation plants, are available, *P. serratus* may be considered a possible choice for temperate-region shrimp farming. Yet a number of biological problems still await solution, and the economic feasibility remains to be demonstrated.

PHILLIPS (1971) placed freshly caught individuals—including immature forms, ovigerous females, adult males and non-ovigerous adult females—in aerated fibre-glass tanks (3.6 × 2.4 m with 45 cm of water for adult breeders and immature forms; 1.05 × 0.6 m with 25 cm of water for ovigerous females). The latter were accommodated singly or, more often, in groups of 6 to 9. In some cases, selected individuals were paired, but the majority of larvae were obtained from uncontrolled matings in the communal adult tanks. Artificial egg incubation was hampered by bacterial infection. An inverted, cone-shaped fibre-glass vessel (30-cm diameter, 30-cm cone length plus a top cylindrical section of 7.5 cm) served as incubator. Continual, gentle water movement was maintained with a ceramic air diffuser placed into the point of the cone. In another study, PHILLIPS, G. C. (1972) mated cultured *Palaemon serratus* with coloured liquid latex injections. The marks were retained through moults; colour combinations, as well as position coding, facilitated individual identification.

The food value of brine shrimp nauplii to larvae of *Palaemon serratus* has been evaluated by WICKINS (1972), FORSTER and BEARD (1969, 1973), FORSTER (1970) and COWEY and FORSTER (1971).

Palaemon serratus and *Penaeus kerathurus* exhibit two maxima each day in their digestive enzymatic activities. This rhythm diminishes progressively in darkness, but can be re-established after brief (30 mins) periods of illumination (VAN WORMHOUDT and CECCALDI, in press). In *P. serratus*, wave lengths of 360, 540 and 630 nm turned out to be most efficient in stimulating enzyme activities. After prolonged exposure to darkness, the shrimps' response to brief light exposure is proportional to the amount of illumination received. The amplitude of enzyme-activity variations attains a maximum under close-to-natural photoperiods. Interestingly, individuals deprived of their ocular peduncles respond in the same way to changes in photoperiod as do the controls.

Palaemon macrodactylus was introduced to the San Francisco Bay system from Japan, probably in the early 1950's (NEWMAN, 1963). Its larvae are easy to rear; they provide suitable material for ecological and physiological studies and can be used as assay organisms. LITTLE (1969) collected gravid *P. macrodactylus* females in Lake Merritt, Oakland, and in the Petaluma River, both California (USA), at salinities ranging from 50 to 70‰ sea water and temperatures close to 20° C. Females were kept individually until hatching, which always occurred at night. Freshly hatched larvae were transferred to finger bowls (10 individuals per bowl) and maintained in sea water under a photoperiod of 12 hrs light at 20° C. They received newly hatched nauplii of *Artemia salina* as food. Survival of postlarvae was 84% or better; most larvae went through 6 larval stages. The number of days required for completion of larval development varied from 11 to 21 days; it was related to

the number of larval stages, and varied with the season (see also HOFFMAN, unpublished). Commercial cultivation of *P. macrodactylus* has not yet been attempted.

Palaemonetes Species

The genus *Palaemonetes* comprises species which occupy a wide variety of habitats with salinities ranging from marine conditions to fresh water. Members of 7 species have been reared through metamorphosis under laboratory conditions: the limnic *P. argentinus* (MENU-MARQUE, 1973), *P. cummingi* (DOBKIN, 1971), *P. kadiakensis* (BROAD and HUBSCHMAN, 1960, 1963; HUBSCHMAN and ROSE, 1969), *P. paludosus* (DOBKIN, 1963); and the marine-brackish *P. intermedius* (BROAD and HUBSCHMAN, 1962; HUBSCHMAN and BROAD, 1974) and *P. pugio* and *P. vulgaris* (BROAD, 1957a, b; KNOWLTON, 1971; SANDIFER, 1973). While the freshwater forms studied—with the exception of *P. argentinus*—exhibit an abbreviated development, i.e. have a reduced number of larval stages, the marine-brackish species develop through 6 or more larval stages. Information on larval development of *Palaemonetes* species has been provided by SOLLAUD (1923), GURNEY (1924) and SHEN (1939). In *P. pugio*, *P. vulgaris* and, apparently, also in related species, hatching usually occurs at night.

Freshwater-living *Palaemonetes* species exhibit requirements comparable to their marine-brackish counterparts. Collected by pushing a net through vegetation, ovigerous females of *P. cummingi* and *P. paludosus* were transferred to jars filled with habitat water. After hatching, DOBKIN (1963, 1971) placed the larvae in plastic compartmented trays (1 individual per compartment in 50–75 cm³ of filtered habitat water), and kept them at 22° to 24° C or 15° to 31° C. Initially, the larvae received no food; beginning with the third larval stage, or after attainment of the first post-larval stage, nauplii of *Artemia salina* served as food source. Variability in the developmental sequence turned out to be very limited; due to internal food reserves, non-fed larvae develop at the same speed and with comparable rates of mortality as fed ones. At temperatures below 25° C, most larvae require more than 5 days to reach the first post-larval stage. The larval development closely parallels that of *P. antennarius* (MAYER, 1881).

Adult *Palaemonetes intermedius*, collected by HUBSCHMAN and BROAD (1974) in the Beaufort estuary (USA), were accommodated in running sea water and fed macerated parts of several local molluscs. Larvae were raised at 23.7° and 27.0° C in 30‰ S. The water in the culture dishes was changed daily and the larvae received a daily portion of *Artemia salina* nauplii. Newly hatched larvae of *P. intermedius* are about 3.5 mm long (Fig. 5-59) and considerably larger than the first zoea of either *P. pugio* or *P. vulgaris* (Table 5-70).

The earliest study on larval development of *Palaemonetes vulgaris* has been conducted by FAXON (1879). Recently, *P. vulgaris* larvae have been reared by SANDIFER (1973) at 20°, 25° or 30° C and in 5, 10, 15, 20, 25 or 30‰ S. At all temperatures, the highest mortalities occurred in 5‰ S. In higher salinities, survival was similar at 20° and 25° C (>60%), but was significantly less at 30° C in most test salinities. Among the individuals which survived to the post-larval stage, considerable variation in the number of larval instars was observed. Optimum conditions for larval development occurred at a moderate temperature of about 25° C over a wide range of salinities (10 to 30‰).

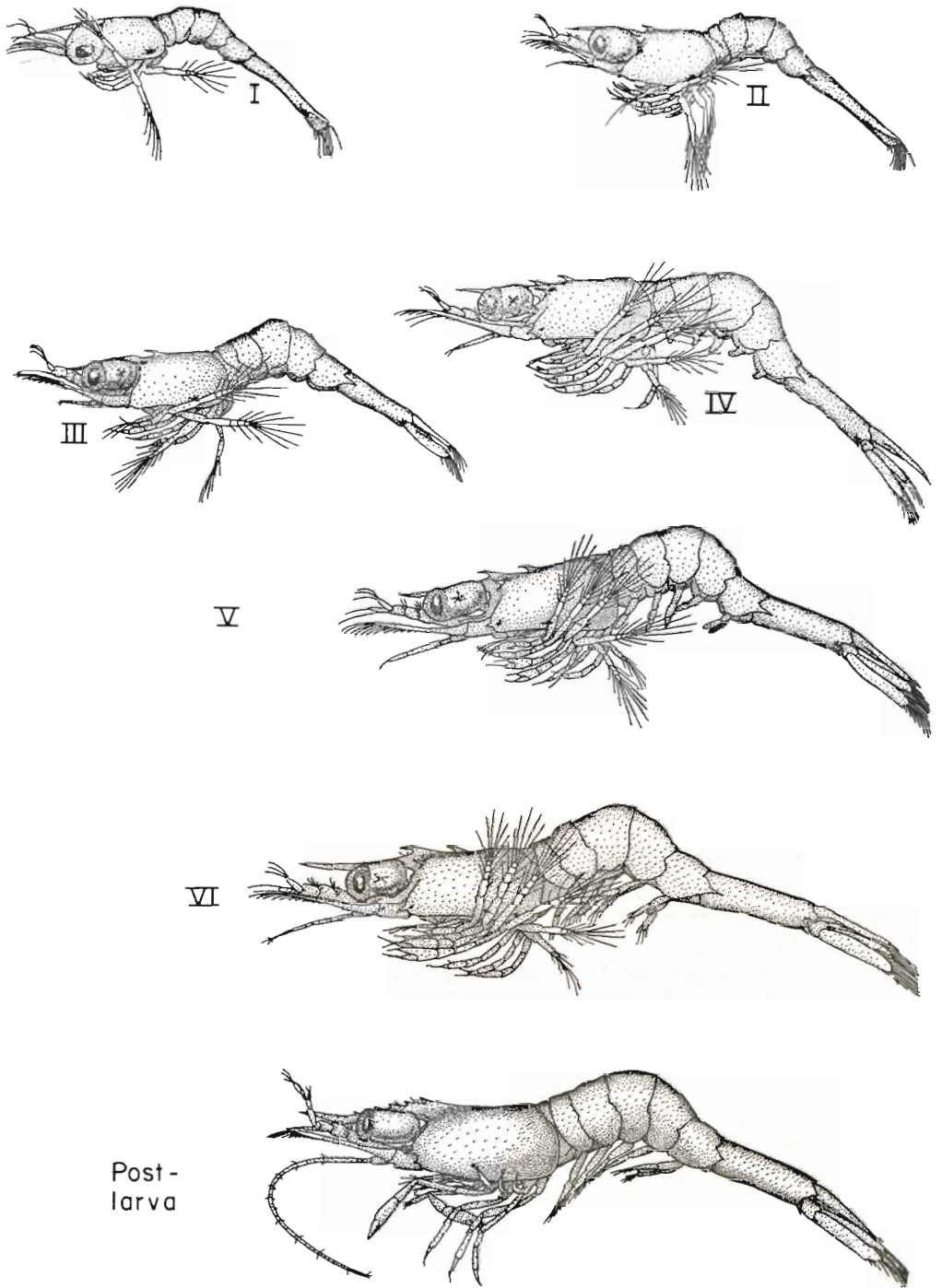

Fig. 5-59: *Palaemonetes intermedius*. Larval stages (Zoeae I to VI) and postlarva. Newly hatched larvae are ca 3.5 mm long). (After HUBSCHMAN and BROAD, 1974; modified; reproduced by permission of E. J. Brill, Leiden.)

Table 5-70

Some key characteristics of *Palaemonetes* species (Compiled from the sources indicated)

Species	Body length (mm)		Number of larval stages	Habitat	Author
	at hatching	at metamorphosis			
<i>P. argentinus</i>	?	?	9	Fresh water	MENU-MARQUE (1973)
<i>P. cummingsi</i>	4.8	5.5	3	Fresh water	DOBKIN (1971)
<i>P. intermedius</i>	3.5	7.0	6-8	Marine-brackish	HUBSCHMAN and BROAD (1974)
<i>P. kadiakensis</i>	4.4	7.5	5-8	Fresh water	BROAD and HUBSCHMAN (1963)
<i>P. paludosus</i>	3.8	4.5	3	Fresh water	DOBKIN (1963)
<i>P. pugio</i>	2.6	6.3	7-11	Marine-brackish	BROAD (1957a)
<i>P. vulgaris</i>	2.3	6.3	7-11	Marine-brackish	BROAD (1957a)

Pandalus Species

An inhabitant of the Pacific coast of North America, the ocean shrimp *Pandalus jordani* comprises 95 to 97% of the shrimp catch taken off California, Oregon and Washington (MODIN and COX, 1967). Freshly collected ovigerous females were transferred to an especially designed, semi-open sea-water system (Fig. 5-60), providing filtered, ultra-violet-treated water of 10° to 13° C. Five days later, the first larvae appeared. They were removed with a large-mouthed pipette and placed in floating, compartmented containers, the bottoms of which had been replaced with synthetic screening (202- μ m 'Nitex'). The styrofoam-float-supported containers were suspended in one of the 5 aquaria of the culture system (for a similar arrangement see Fig. 2-155, p. 241). A single larva was placed in each compartment, and all larvae received nauplii of *Artemia salina* as food. In order to locate the small, nearly transparent larvae during feeding and observation, MODIN and COX removed the rearing compartments from the aquaria and placed them in a black, shallow Pyrex dish containing water tapped from the system. The larvae passed through 11 to 13 zoeal stages. One shrimp reached the adult stage in 79 days. Possibly, the larvae go through fewer larval stages and grow faster under natural conditions.

Larvae of the spot prawn *Pandalus platyceros* were grown successfully by SERFLING and co-authors (1974a) in a system developed for mass culturing lobster larvae (Fig. 5-66). At 20° C, newly hatched *P. platyceros* reached the benthic stage in 10 to 15 days, with survival rates of about 70%.

Penaeus japonicus

An early breakthrough in natantian mass cultivation was achieved in the Japanese kuruma ebi (or abi), the commercially important kuruma prawn (shrimp) *Penaeus japonicus*. This decapod inhabits coastal waters from central to southern

Japan. Mass cultivation of *P. japonicus* has been pioneered by HUDINAGA (1935, 1942). Most culture techniques now in use are based on his work, as well as on studies by HUDINAGA and MIYAMURA (1962), FUJINAGA (1963, 1969), HUDINAGA and KITTAKA (1966, 1967) and the more recent investigations by SHIGENO (1970) and KITTAKA (1971). In 1971, the total annual production of marketable *P. japonicus* was estimated at 6000 tons, harvested from a pond area of some 10,000 ha. Kuruma ebi is the most expensive sea-food item in Japan (DESHIMARU and SHIGENO, 1972). *P. japonicus* has received more attention from experimental ecologists and mariculturists than any other natantian (see also Chapter 5.2).

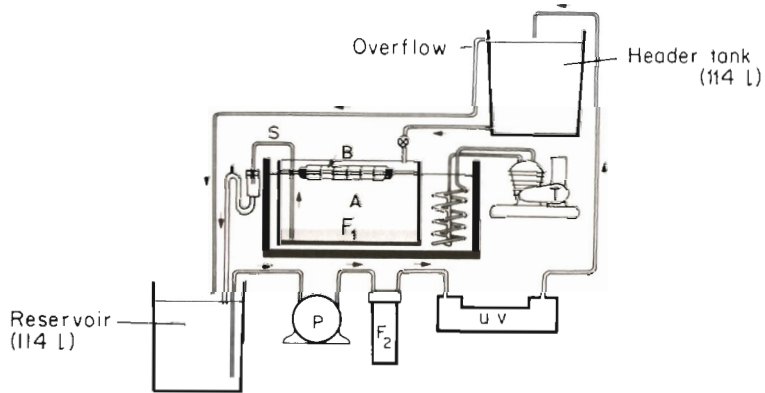

Fig. 5-60: Semi-open culture system designed for sustaining larvae of *Pandalus jordani*. Larvae are accommodated in a floating compartmented box (B), one per compartment. Arrows indicate direction of water flow: header tank to aquarium (A), through sand filter (F_1) and siphon (S) to reservoir, via pump (P) through 15- μ m Orlon filter (F_2) and ultra-violet disinfectant (UV) back to header tank. T: thermostat. (After MODIN and COX, 1967; modified; reproduced by permission of E. J. Brill, Leiden.)

Reproduction

In the sea, *Penaeus japonicus* copulates throughout the year. Following the female's moult, the male transfers spermatophores into the female's receptaculum seminis. Oviposition lasts from mid May until the end of September. Fertilized by sperm from the receptaculum seminis, the eggs are dispersed freely into the water. *P. japonicus* also copulates readily under culture conditions. A single *P. japonicus* female produces an average of 400,000 and a maximum of 1,200,000 eggs (FUJINAGA, personal communication).

Rearing of larvae

Under optimum conditions (26° to 29° C; 32 to 35‰ S), development of *Penaeus japonicus* from egg to nauplius takes 14 hrs; from nauplius to protozoa (6 moults), 36 hrs; from protozoa to mysis (3 moults), 5 days; from mysis to the first post-larval prawn (3 moults), 5 days (FUJINAGA, personal communication). The post-larva settles to bottom life (20 to 22 moults), attaining adulthood after about 40

days and at a body length of about 6 cm. Survival from egg to seedling (~ 17 mm) averages 35%. The nauplius lives on yolk and does not require external food. For the zoea, which is sensitive to direct sunlight, planktonic food must be readily available in high density.

The principal foods for larvae and early post-larval stages of *Penaeus japonicus* are listed in Table 5-53. In order to simplify management procedures, HUDINAGA and KITAKA (1967) have raised larvae of *P. japonicus* together with their planktonic food organisms (*Skeletonema costatum*, eggs and larvae of bivalves, benthonic diatoms). They used outdoor culture tanks (10 × 10 × 2 m deep), filled with raw sea water filtered through a mesh net. For spawning, 30 to 100 females were placed in each tank, and nutrient salts (daily portion for each tank: potassium nitrate, 200 g, potassium phosphate, 20 g) were added prior to the day on which the zoeal stage was attained. The water in the culture tank remained unchanged until 1 week after attainment of the post-larval stage. From then on, 1/5 of the total water volume was exchanged daily with fresh sea water. Thorough mixing of prawn larvae and their planktonic food by aeration facilitated substantial savings in conventional food (cultured diatoms, larvae of *Artemia salina* or of short-necked clams *Venerupis philippinarum*). Survival from nauplius to juvenile was 24% and the average production per culture tank was 1000×10^3 young *P. japonicus*.

For mass rearing of *Penaeus japonicus* larvae, FUJINAGA (personal communication) has suggested the following method: (i) Fill a large (about 12 × 12 × 2 m deep) concrete tank with sea water, passed through a Teflon bag to keep out too large amounts of particulate matter, and aerate the water freely for some days. (ii) Add fertilizer, e.g. per 100 tons of sea water: potassium nitrate, 50 g; potassium phosphate, 5 g; silicate, 2.5 g. (iii) Add a natural mixture of phytoplankters and allow these to attain high population densities; introduce females ready to spawn, or nauplii ready to moult to zoeae. (iv) When the first mysis larvae appear, add nauplii of *Artemia salina* as additional food source as well as ground clam and shrimp meat. (v) When the first postlarvae appear, feed small pieces of annelids, bivalves, crustaceans and fish; while the daily food supply has to be sufficient to avoid cannibalism, overfeeding and water fouling must be carefully avoided (initially, 10,000 postlarvae receive 20 g of food day⁻¹; after 10 days, 60 g; at the end of the 20-day growing period, about 100 g). (vi) Transfer juveniles to production ponds. From here, they are sold as seedlings, or released in coastal waters to augment the natural population.

The provision of proper plankton food in the culture tanks depends on weather conditions, since diatoms such as *Skeletonema costatum*, *Chaetoceros* spp. or *Nitzschia* spp. grow well only if the sun shines. Hence, frozen diatoms (MOCK, 1971), freeze-dried diatoms (BROWN, 1972, for *Penaeus aztecus*) and frozen marine yeast (FURUKAWA, 1972) have been tried as feeds. However, as HIRATA and co-authors (1975) have pointed out, such procedures require special equipment and considerable manpower. In the search for an easier-to-prepare and more convenient-to-handle food source, HIRATA and co-authors have raised larvae of *P. japonicus* on a mixture of soy-cake particles and diatoms (p. 818).

The development of larvae and juvenile *Penaeus japonicus*, hatched from eggs collected from newly captured adult females, has been studied by BANG (1970). At 25° C, spawners with mature gonads released their eggs within a day. Two or 3

times a day, the zoeae were fed cultured *Skeletonema costatum* and natural plankton. Average survival rate from egg to young shrimp was 5%; from egg to nauplius, 91%; from nauplius to zoea, 70%; from zoea to mysis, 69%; from mysis to postlarva, 79%; from postlarva to young prawn, 14%. Especially at the zoeal stage, aeration must be sufficiently strong to spread the food evenly over the culture water. Growth rates of each part of the body of *P. japonicus*, in conjunction with exuviation and moulting cycle, have been analyzed by CHOE (1971). Increases in carapace, length and body weight conformed to the general pattern described by HILTT (1948) for the shore crab *Pachygrapsus crassipes*, with no difference in growth resulting from sex, or inflexion point in juveniles. The moulting cycle of *P. japonicus* weighing 1.5 to 15 g was 6 to 17 days at 20° to 28° C; it was prolonged in proportion to increasing size. Two kinds of food were used: anchovy and short-necked clams; the nutritional value of anchovy was generally greater; combined, the two feeds promoted growth more than either one offered singly (see also CHOE, 1970).

The effects of temperature, salinity, oxygen, pH and organic matter on survival and growth of *Penaeus japonicus* and *P. kerathurus* have been studied by TOURNIER (1972). Oxygen concentration in the culture water is of prime importance. The risks of culture-pond pollution due to poor food rationing are considerable. Oxygen values should be monitored continuously and aeration intensity adjusted automatically to counteract oxygen deficiencies. Redox potentials of bottom materials in *P. japonicus* ponds have been determined by TANAKA and INOUE (1965).

Production of seedlings

Only few Japanese culturists breed *Penaeus japonicus*; most obtain juveniles from specialized seedling producers and concentrate on fattening to market size. Seedling producers, in turn, obtain breeders (females of 50 to 150 g with spermatophores) from fishermen or maintain their own stock.

Females ready to release their eggs are transferred into tanks (5 to 15 m², 1 m deep) allowing 1 to 3 m³ of gently-aerated sea water per female. During oviposition, the female swims about actively, separating and distributing the eggs with its pleopods. If disturbed during egg laying, the female may stop swimming; consequently, the eggs come out in a big mass and 'don't do very well' (FUJINAGA *in*: COSTLOW, 1969, p. 190). After spawning, the females are usually removed and sold on the market. Oviposition is possible at temperatures between 22° and 33° C and in salinities between 28 and 36‰, but 25° to 29° C and 32 to 35‰S are considered optimal (HUDINAGA, 1935, 1942; HUDINAGA and MIYAMURA, 1962; HUDINAGA and KITAKA, 1966, 1967).

Seedling transportation

During transportation, seedlings may injure or eat each other. On short trips, Japanese farmers place them in boxes (1 × 0.7 × 0.3 m deep) with fine mesh tops and bottoms, set in a tank with water circulation (25° C); losses due to cannibalism of up to 30% are accepted. On long trips, up to 10 hrs, seedlings (5000 to 10,000 in a 20-l polyethylene bag containing 6–8 l of sea water and a supply of oxygen) are exposed to low temperatures—initially 5° to 15° C—and gradually raised during transport to the temperature of the receiving water. Thus 600,000 to 700,000 seedlings can be transported in a 2-ton refrigerated lorry at a cost amounting to

about 3 to 5% of the price of the seedlings (Takamatsu Shrimp Farming Co. Ltd., personal communication).

Fattening

During fattening to market size in production ponds, the most crucial factors are water quality and oxygen. To avoid critical accumulation of waste products (excreta and uneaten food), considerable amounts of running water and effective aeration are needed. The lowest acceptable oxygen level is 4.0 ppm. Large, floating net cages or netted flow-through tanks, placed in natural, moderately-moving waters, seem ideal, but such *in situ* techniques have not yet been developed by commercial shrimp farmers. Production ponds in Japan vary from 0.01 to 10 ha or more. Small ponds are usually made of concrete. They are more expensive to build, but more economical to maintain, than the large earthen-banked ponds (see also BROOM, 1969). According to BARDACH and co-authors (1972), some shrimp-growing industries use a combination of small and large ponds with a total area of perhaps 10 ha. Production ponds are 1 to 2 m deep and have a sand layer on the bottom. The lowest amount of water exchange is about a quarter of the culture water per tidal cycle; faster exchange rates are obtained by pumping water out of the end pond, and result in higher shrimp production per water surface area. The Shrimp Farming Co. Ltd. in Takamatsu also grows kuruma shrimp in concrete or wooden tanks (60 × 10 × 1.3 m deep) with an air-water-lift-operated inside sand filter (p. 115). The filter is supported by a horizontal nylon screen and reduces the requirements for water exchange by more than 50%. Over the summer, seedlings attain market size and are harvested after 5 to 6 months. According to FUJINAGA (personal communication), the production per unit area is 200 to 400 g m⁻². Following harvest, the production ponds are drained, scrubbed, rinsed and dried for 1 to 2 weeks (see also HUDINAGA and KITAKA, 1967).

Extensive embayment culture

Extensive embayment culture is based on stocking selected natural waters (e.g. bays, lagoons), located in climatically suitable regions with high-quality sea water. Introduced from hatcheries, young shrimps grow in these waters on natural productivity. Like wild populations, they are harvested by trawlers. Extensive embayment culture has been initiated in Florida (USA) on the northern coast of the Gulf of Mexico (WEBBER, personal communication). Predators are controlled by fencing off the mouth of a bay, and by applying rotenone or some other fugitive or short-lived fish poison, killing all large predators trapped; after the poison has dissipated, the bay is stocked with post-larval shrimp from a hatchery. However, such extensive cultures cannot be expected to yield as much per acre as do intensively managed cultures, e.g. in raceways or ponds (Chapter 5.2).

In an extensive embayment plant, yields of 700 to 800 pounds per year can be expected in a one-crop year. In an intensive pond plant, the yield may be as high as 3000 pounds per acre in a three-crop year (WEBBER, 1970). However, capital cost is much lower in extensive embayment culture than in intensive pond culture. Predator control and maintenance of ships and nets make up the most important costs involved in embayment farms, while construction and feed constitute the main expenses in pond systems.

Stocking

With the Japanese kuruma-shrimp industry becoming increasingly successful, large numbers of cultivated juveniles (10–15 mm) are released in natural habitats to augment local *Penaeus japonicus* populations and to assist shrimp fisheries. Such stocking projects are conducted by governmental agencies; they are restricted to sandy-bottomed inlets and bays in which the shrimp are likely to remain and do not encounter heavy predation. Prefectural governments, in consultation with fishermen's cooperatives, select the habitats to be stocked. When the shrimp have reached harvestable size, stocked waters are opened for fishing (see also Chapter 5.2, p. 1327).

Penaeus monodon

The 'sugpō' or jumbo tiger shrimp *Penaeus monodon* is commercially cultivated in the Philippines and on Formosa. Sugpo farms have become an important and lucrative enterprise. The shrimp rank next to the *Chanos chanos* fry in market value (VILLADOLID and VILLALUZ, 1951; DELMENDO and RABANAL, 1956; BORJA and RASALAN, 1957; KESTEVEN and JOB, 1957; CACES and RASALAN, 1968). The annual *P. monodon* harvest amounts to 50–200 kg ha⁻¹ from the normal incidental shrimp population that enters an estuarine nursery pond; the production may be raised to 500 kg ha⁻¹ by adding fry to the pond. Sugpo fry are collected from natural waters (tidal creeks) by 'bon-bon' lures made of a bunch of water grass. After increasing in size, the small prawns are collected from the nursery ponds and stocked in rearing ponds, either alone or together with *Chanos chanos*. Best results are obtained when *P. monodon* is stocked alone. The prawns attain marketable size within 6 to 12 months.

The main problems in farming *Penaeus monodon* are (i) the uncertain and limited supply of stocking material (seedlings): the season for fry collection varies from year to year; (ii) harvesting difficulties due to the non-gregarious habits of the prawn; (iii) poor fry survival (about 10–50%). For further details (e.g. growth rates, trapping) consult DELMENDO and RABANAL (1956) and BORJA and RASALAN (1957). A synopsis of biological data on *P. monodon* has been provided by MOHAMED (1970a).

Other *Penaeus* Species

A number of other *Penaeus* species have been shown to exhibit environmental and nutritive requirements similar to those of *Penaeus japonicus* and *P. monodon*. The brown shrimp *P. aztecus*, pink shrimp *P. duorarum* and white shrimp *P. setiferus*, which constitute the main shrimp catch in North Carolina, USA (BROAD, 1950), have been reared by several investigators. The larvae were offered the following food organisms: *Skeletonema costatum*, *Eucampi* sp., *Gymnodinium splendens*, *Tetraselmis* sp., *Thalassiosira* sp., larvae of *Artemia salina* and a euglenoid protozoan.

Growth rates of cultured *Penaeus aztecus* have been studied by ZEIN-ELDIN (1962) and ST. AMANT and co-authors (1963); influence of temperature and salinity

on growth rates, by ZEIN-ELDIN (1963), ZEIN-ELDIN and ALDRICH (1965), ZEIN-ELDIN and GRIFFITH (1966) and VENKATARAMIAH and co-authors (1975, in press). COOK (1969) reared *P. aztecus* from egg to postlarva to supply test animals for physiological studies and for stocking small experimental ponds. Guidelines for predicting *P. aztecus* production have been worked out by FORD and ST. AMANT (1971) and a synopsis of biological data on *P. aztecus* has been provided by COOK and LINDNER (1970).

The microbial flora of freshly caught *P. aztecus* (Gulf of Mexico) was found to vary considerably; it was dominated by coryneforms and by species of *Pseudomonas*, *Moraxella* and *Micrococcus* (VANDERZANT and co-authors, 1970). Interestingly, bacterial counts on pond-cultured individuals were much lower.

VENKATARAMIAH and co-authors (1973a, b) reared *Penaeus aztecus* postlarvae (6 to 8 mm) in 95-l glass aquaria with bottom sand filters (photoperiod: 14 hrs light; 26° C; 28‰ S; first food: *Artemia salina*, later food: pellets). Over 2 months, mortality was 1.7%. Round, plastic, children's wading pools (ca. 2.5 m in diameter, 0.2 m deep) served as culture enclosures for juveniles (VENKATARAMIAH and LAKSHMI, 1973). A layer of crushed oyster shells and fine sand on the pool bottom was used both as substrate and as inside filter. To prevent the shrimp from jumping out, the pools were covered with mosquito curtain cloth. The shallow wading pools turned out to be more acceptable to the shrimp than culture tanks. Fighting frequency decreased with increasing bottom area available per shrimp.

Methods for cultivating *Penaeus duorarum* have been developed by COOK (1969) and IDYLL and co-authors (1970). THORHAUG and co-authors (1971) added further refinements with a view to providing optimum temperature levels for early developmental stages. Newly hatched *P. duorarum* metamorphose to the protozoa only at temperatures between 24° and 31.5° C. The optimum range lies between 27° and 28° C. The mysis is not able to develop to the postlarva at temperatures above 37° C or below 14.6° C. The upper lethal temperature for the first postlarva is about 37° C, the safe limit 33.5° C. An effective method of mass cultivating freshly hatched nauplii of *P. duorarum* is to hold them in large 20-ton tanks in air-conditioned (27° to 29° C) rooms. In view of rather specific thermal requirements for maximum growth, temperature control is necessary in climatic zones where temperatures deviate significantly from the above mentioned values. Early stages of *P. duorarum* have received attention from COSTELLO and ALLEN (1959, 1961), DOBKIN (1961) and EWALD (1965). COSTELLO and ALLEN (1970) provided a synopsis of biological data on the species.

Penaeus kerathurus has been mass cultured from egg to postlarva by LUMARE and co-authors (1971). They consider light and temperature conditions to be especially important for survival and growth, and provide technical data for the construction of commercially operated farms. Spermatophore formation in *P. kerathurus* has been studied by MALEK and BAWAB (1974). LUMARE and VILLANI (1974) spawned mature *P. kerathurus* in laboratory and outdoor tanks. At 27° C and 35‰ S, the eggs hatched after 12 hrs. As in related species, the larvae are first phytoplankton eaters; later they primarily consume animal food (e.g. *Artemia salina* nauplii). The post-larval stages were transferred to *in situ* cage-nets; they grew rapidly on a variety of natural and artificial diets as long as the temperature was high.

Penaeus latisulcatus, the western king prawn, produces between 200,000 and

300,000 eggs per female. About 10% of the eggs could be hatched under culture conditions and raised to the post-larval stage (POWNALL, 1974). Between 100,000 and 500,000 larvae were maintained in tanks of 1 ton capacity at temperatures between 25° and 28° C (considered optimal). For post-larval development, 9- to 12-ton tanks were provided. On a diet of plankton and a special food mix, good growth was obtained.

For *Penaeus merguensis*, *P. monodon* and *P. semisulcatus*—as well as for *Metapenaeus monoceros* (p. 847),—DOUMENGE (1973) has discussed initial organizational work for farming operations. As most other penaeid prawns, *P. merguensis* is nocturnal (HINDLEY, 1975).

Data on life history, reproduction and distribution of *Penaeus setiferus* have been presented by WEYMOUTH and co-authors (1933), PEARSON (1939), HEEGAARD (1953) and LINDNER and ANDERSON (1956). LINDNER and COOK (1970) provided a synopsis of biological data, and suggested that *P. setiferus* is well suited for pond culture. Cultivation experiments have been conducted by JOHNSON and FIELDING (1956), LUNZ (1958, 1967a, b), LUNZ and BEARDEN (1963) and COOK (1969). Commercial cultivation has not yet been attempted.

Penaeus schmitti is valued as an important food source for commercial fishes caught on the Cuban shelf. Its distribution, reproduction, development and laboratory cultivation have been discussed by MORALES (1971). A female is capable of producing from 500,000 to 1,000,000 eggs which develop through nauplius, protozoa, mysis, postlarva and juvenile to the adult stage. A synopsis of biological data on *P. schmitti* has been compiled by PEREZ-FARANTE (1970). In a recent study, PÉREZ PEREZ and ROS (1974) studied post-larval growth as a function of temperature and salinity. Synopses of biological data on *P. indicus* have been presented by MOHAMED (1970b).

Sergestes lucens

The mesopelagic shrimp *Sergestes lucens*, commercially fished in Suruga Bay (Japan), was reared from egg to post-larval Stage V by OMORI (1971). This is the first case of successful sergestid-shrimp cultivation. Meso- and bathypelagic shrimps represent major constituents of the ocean's biomass. In the North Pacific Ocean, species of the genera *Sergestes*, *Acanthephyra*, *Genadas* and *Hymenodora* are most abundant (PEARCY and FORSS, 1966, 1969; AIZAWA, 1969). Only a few observations on larval stages are available (e.g. GURNEY and LEBOUR, 1940; FOXTON, 1964; HERRING, 1967; AIZAWA, 1968). OMORI collected *S. lucens* eggs by vertical plankton hauls, about 1 km off the coast of Yui (Japan), using a Norpac net with 0.1-mm mesh width. The eggs were incubated (Millipore-filtered habitat water of 33.9‰S) in 50-ml glass tubes, each containing 5 eggs, or in 1000-ml beakers, each containing 20 eggs, at 15°, 17°, 20°, 23° or 26° C. In order to determine the effect of salinity, 30.4‰, 31.9‰, 33.0‰ or 34.5‰S were offered at 20° C. Optimum temperatures for larval development lie between 20° and 23° C (18° to 25° C); eggs and larvae tolerated all salinities offered. OMORI assumes that *S. lucens* attains a length of 20 mm about 4 months after hatching. At 20° C, length increase of larvae amounts to about 0.16 mm day⁻¹; at 23° C, 0.21 mm day⁻¹. The larvae first feed on phytoplankton

(maximum mortality at elaphocaris Stage I), and then gradually become carnivorous at post-larval stages (p. 817).

The feeding activity of sergestid shrimps has been discussed by DONALDSON (1975). Although most forms eat a variety of organisms, the foreguts of *Sergestes corniculum*, *S. grandis* and *S. splendens* contained euphausiids more often than other species; *S. japonicus* appears to eat detritus. Most species examined seem to feed primarily at night.

Decapoda Reptantia (Lobsters and Crabs)

Lobsters: General Aspects

The true lobsters (superfamily Nephropsidea), which include the family Homaridae with the genera *Homarus* and *Nephrops*, are distinguished by having their first 3 leg pairs terminating in chelae from the spiny and Spanish lobsters (superfamily Scyllaridae), which include the genera *Ibacus*, *Jasus*, *Panulirus* and *Scyllarus* and whose first 3 leg pairs are non-chelate. The first chelae of the Nephropsidea are usually large. Among the true lobsters, the American lobster *Homarus americanus* and the European lobster *H. gammarus* (syn.: *H. vulgaris*) represent important fishery objects. Famous for size and taste, both have attracted considerable attention from experimental ecologists, mariculturists, physiologists and ethologists. A fair amount of information is available on environmental tolerance, osmoregulation, non-genetic adaptation, behaviour, embryonic and larval development, growth, reproduction and nutrition. Sea-food farmers and governmental agencies have initiated activities to farm these high-priced delicacies and to improve the natural productivity of lobster populations through stocking. Unfortunately, practically all stocking programmes have failed.

Homarus Species

Homarus americanus and *H. gammarus* inhabit the northwest and the northeast Atlantic Ocean, respectively. Both species (or races?) exhibit similar, in part even identical, patterns of development, growth, reproduction and behaviour. A comparison of growth and thermal tolerance of larval stages (GRUFFYDD and co-authors, 1975) revealed only minor differences in responses to high temperature (*H. americanus* is slightly more tolerant to high temperatures at larval stages 1 and 2), in size (*H. gammarus* larvae are larger at all stages), and in some taxonomical characteristics.

Pioneering contributions to the cultivation of *Homarus americanus* and *H. gammarus* have been made by RATHBUN (1886), HERDMAN (1894), CUNNINGHAM (1898), MEAD (1901, 1908), EHRENBAUM (1903), WILLIAMS (1904), BARNES (1905), HADLEY (1906), MEEK (1909/1910), KNIGHT (1916), DANNEVIG (1928), HAGMEIER (1933), TEMPLEMAN (1934), SMITH and CREGEEN (1935) and GALTSOFF (1937). Recent developments and assessments of the present state of lobster cultivation have been presented by MUNDEY (1969), THOMAS (1969), KENSLER (1970), BOWBEER (1971), BARDACH and co-authors (1972), RENSBERGER (1972) and SHLESER

(in press). A comprehensive natural history of *H. americanus* has been presented by HERRICK (1909), and an extensive bibliography of studies devoted to members of the Homaridae by NOWAK (1972).

Rearing of larvae

Hatching larvae of *Homarus americanus* and *H. gammarus* from ripe eggs is no problem. Either berried females are allowed to incubate their eggs until hatching, or the eggs are removed and incubated artificially. In the latter case, a female carrying ripe (brownish) eggs is stretched on its back over a table and, by carefully and softly moving the dull side of a knife against her abdomen, the eggs are detached from her swimmerets (GALTSOFF, 1937). Alternatively, parts of swimmerets with attached eggs may be cut off. The eggs are then immediately transferred into an

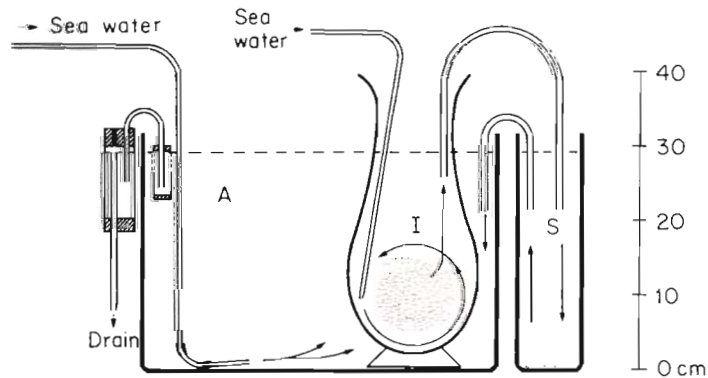

Fig. 5-61: Incubator for hatching lobster eggs. A strong flow of filtered sea water rotates the eggs in the incubator (I). Hatched larvae enter the sorting vessel (S), where abnormal or dead individuals and debris are removed. Finally, the living larvae accumulate in the aquarium (A). From here, the water drains to waste through a screened constant-level overflow. (After HAGMEIER, 1933; based on EHRENBAUM, 1910; modified; reproduced by permission of Urban and Schwarzenberg, Munich.)

incubator (Fig. 5-61) and exposed to a current of sea water. Sufficient irrigation with clean (filtered) and oxygen-saturated sea water of stabilized temperature (e.g. 15° to 25° C) is essential for proper egg development.

Freshly hatched larvae are about 8 mm long and transparent. Their pelagic life continues for 3 moults (about 3 weeks at 15° C). During this period—comprising the larval stages 1 to 3—larvae held at high individual densities often attack each other (usually from above), biting into the junction between carapace and abdomen. After the 4th moult, the larvae become increasingly attracted to bottom life. They seek hiding places, shun bright light and begin to resemble the adults in form and behaviour (Fig. 5-62). Red or greenish red, the 4th-stage larvae measure 11 to 14 mm. They can now swim rapidly forward by means of their swimmerets and dart backward by sudden jerks of their abdomen. Sometimes, especially under unfavourable conditions (too low temperature or salinity, insufficient nutrition), an appreciable number of *Homarus americanus* larvae occur that are structurally intermediate between 3rd- and 4th-stage larvae (TEMPLEMAN, 1936a).

Although lobster larvae can tolerate strong sunlight and seem to develop normally in diffuse daylight, survival and growth are better in darkness. *Homarus americanus* larvae reared in almost complete darkness by TEMPLEMAN (1936b) revealed higher survival rates, moulted 3 or 4 days earlier to the 4th stage and were significantly larger in the 4th stage than controls reared in the light of a northwest-facing window. The effect of temperature on larval development is illustrated in Fig. 5-63. TEMPLEMAN reared larvae in salinities between 18 and 35‰ and found salinities of 21‰ only slightly less favourable to survival than habitat salinities near 31‰S.

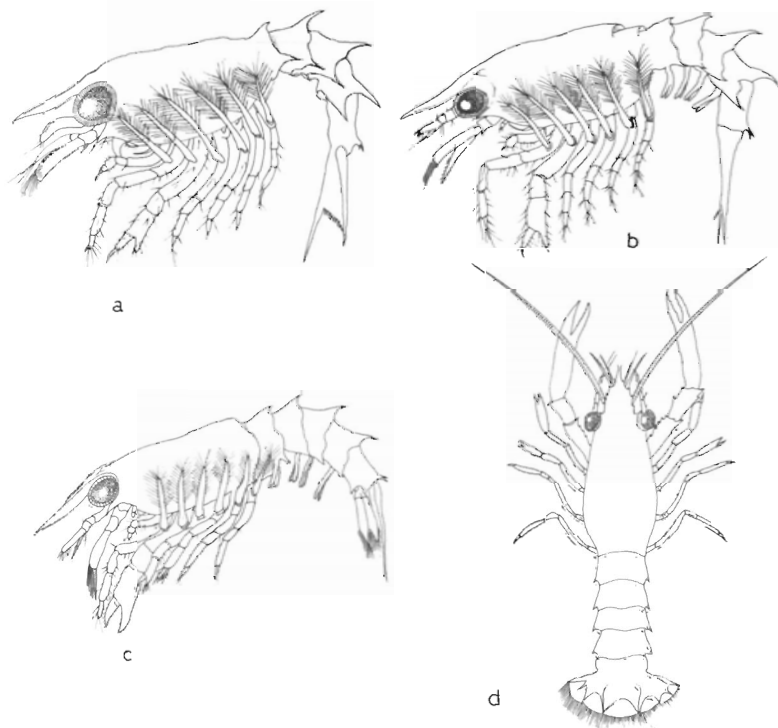

Fig. 5-62: *Homarus americanus*. First- (a), second- (b), third- (c) and fourth-stage (d) larvae. (After HERRICK, 1909; modified; not copyrighted.)

However, according to SCARRATT and RAINE (1967), newly hatched *H. americanus* larvae tend to avoid low salinities in preference experiments.

Small numbers of lobster larvae have been raised in the culture arrangement illustrated in Fig. 5-64, or, singly, in 500-cm³ beakers regularly supplied with new sea water. Continuous availability of lobster larvae throughout the year can best be achieved by temperature-controlled egg development: berried females, collected from the sea, are exposed to different temperature levels adjusted so that their eggs hatch at predetermined times.

Mass cultivation of lobster larvae was successful in the culture system shown in Figs 5-65 and 5-66. Developed by HUGHES and co-authors (1974), this system allowed SERFLING and co-authors (1974a) to raise larvae of *Homarus americanus*, from 1st to 4th stages, at densities of 3000 to 5000 individuals per 38-l culture

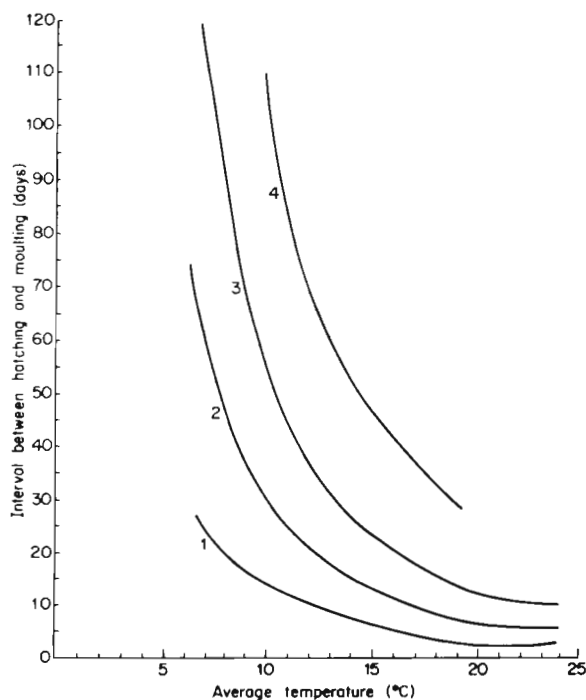

Fig. 5-63: *Homarus americanus*. Number of days between hatching and moults 1, 2, 3 and 4, respectively. (After TEMPLEMAN, 1936b; modified; reproduced by permission of Fisheries Research Board of Canada.)

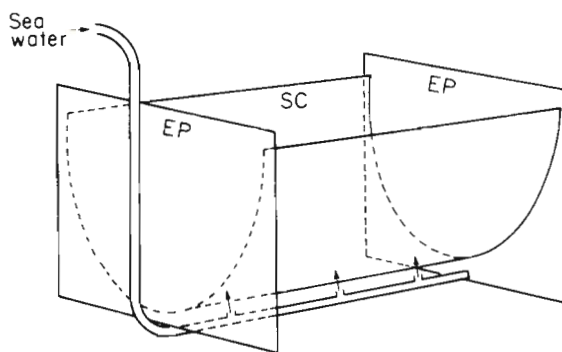

Fig. 5-64: Fitted into an aquarium, this arrangement is used for maintaining lobster larvae until metamorphosis. A perforated semi-cylinder (SC) is glued to unperforated end plates (EP) and receives strong water currents from below. The resulting water movement maintains the larvae in continuous turbination. (After HAGMEIER, 1933, constructed by A. HOLTMANN; modified; reproduced by permission of Urban and Schwarzenberg, Munich.)

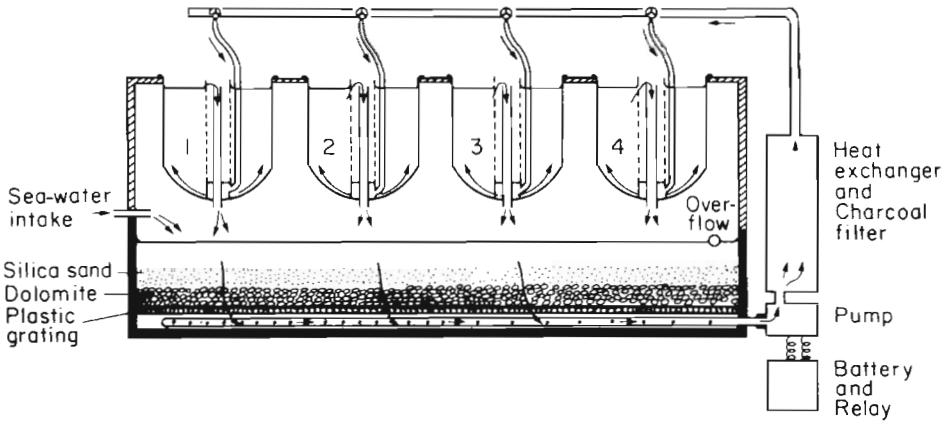

Fig. 5-65: Culture system for mass-raising lobster larvae. The apparatus can be operated as closed, semi-open or open system. 1, 2, 3, 4: culture enclosures, installed over reservoir tank with filter bed. (Based on HUGHES and co-authors, 1974, after SERFLING and co-authors, 1974a; modified; reproduced by permission of Elsevier Scientific Publishing Company, Amsterdam.)

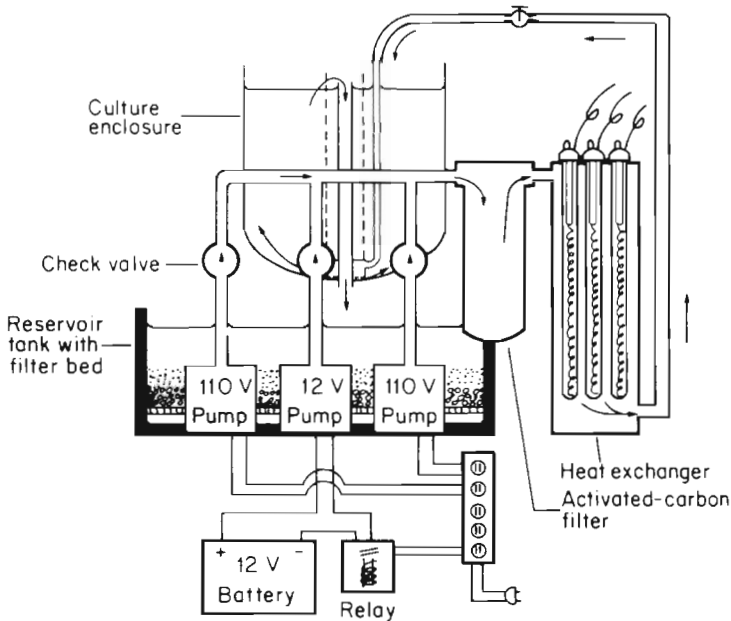

Fig. 5-66: Culture system for lobster larvae: apparatus shown in Fig. 5-65 viewed from right end. Two pumps (30 l min^{-1} each) safeguard the system against circulation breakdown. A 12-V emergency pump takes over in case of electrical power failure. One-way check valves prevent backflow through inoperative pumps. (Based on HUGHES and co-authors, 1974, after SERFLING and co-authors, 1974a; modified; reproduced by permission of Elsevier Scientific Publishing Company, Amsterdam.)

enclosure. At temperatures between 20° and 25° C, survival rates were 70 to 80%. At temperatures of 22° C, the larvae reached the 4th stage within 10 to 12 days. Consisting of fibre glass, each culture enclosure has in its centre a combined overflow and water circulator (Figs 5-67 and 5-68). Depending on the setting of the overflow standpipe, the total capacity of the enclosure varies from 37 to 41 l. Water enters the culture enclosure through slits near the bottom of the overflow-circulator (Fig. 5-68). In order to maintain proper dispersion (avoidance or reduction of cannibalism) and suspension of the larvae, water-flow rates should be maintained at about 10 l min⁻¹. Adding 2 or 3 water-jet holes to the vertical intake pipe adds a horizontal component to the otherwise vertical water-flow direction and optimizes larval distribution.

For routine larval culturing at 22° C, SERFLING and co-authors (1974a) continuously added new sea water to the system at a rate of approximately 1 l min⁻¹. The total volume of the system was 303 l, providing a turnover rate (including the added

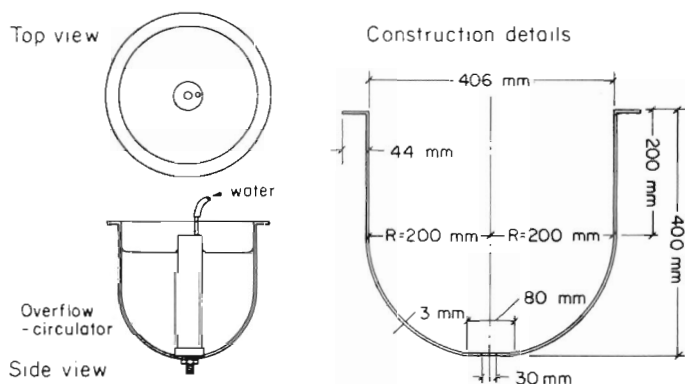

Fig. 5-67: Culture system for lobster larvae: culture enclosure. (After HUGHES and co-authors, 1974; modified; not copyrighted.)

sea water) of about 6 times day⁻¹. In addition, the pumps recycled the water in the culture enclosures at 45 l min⁻¹ (120 times day⁻¹). More efficient filtration may be necessary if the apparatus is run longer than 2 or 3 weeks as a closed system. Infections by the bacterium *Leucothrix mucor* proved to be a major problem in cultivating larvae of *Homarus americanus* (SERFLING and co-authors, unpublished). The disease could be controlled by ozonation and ultra-violet irradiation (Chapter 2). The larvae received *Artemia salina* ('high densities', twice a day). An automatic feeder was developed (Fig. 5-38) which dispenses live or frozen adult *A. salina* and similar food items at 3-hr intervals (SERFLING and co-authors, 1974b).

In considerably less controlled experiments, MEAD (1908) mass-cultured larvae of *Homarus americanus* to the 4th stage in large floating cages under *in situ* conditions. He used rafts (6 × 23 cm) containing numerous rearing cars. Of 20,000 newly hatched larvae, an average of 40% survived to Stage 4. *In situ* experiments with a small number of larvae and juveniles of *H. gammarus* have been conducted by JATZKE (personal communication) in his *in situ* kreisel (Fig. 2-143, p. 232). Of course, management of essential culture aspects (environmental factors,

nutrition, disease) is rather restricted under such conditions, but so is the routine service required.

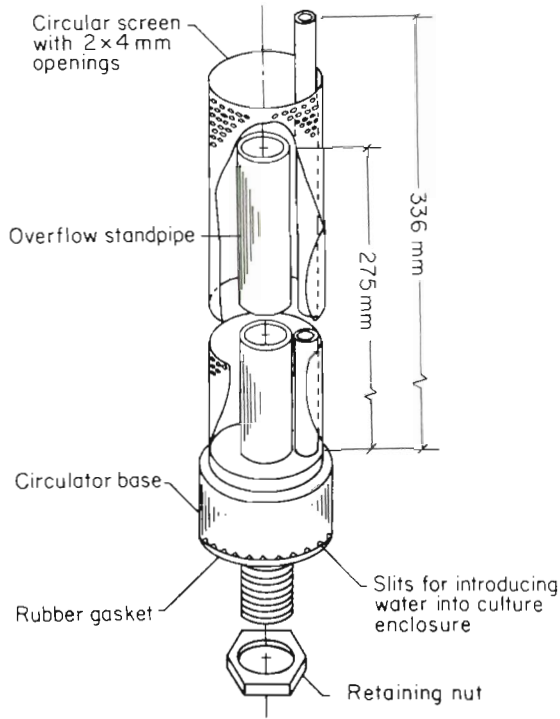

Fig. 5-68: Culture system for lobster larvae: construction details of overflow-circulator. (After HUGHES and co-authors, 1974; not copyrighted.)

Rearing of juveniles

Young lobsters have been cultivated under laboratory conditions (in running, or in stagnant but aerated and regularly renewed sea water) and under *in situ* conditions. A variety of culture enclosures have been used: (i) tanks with sand and/or hiding places (mollusc shells, stones, etc.); (ii) small aquaria or beakers; (iii) compartmented trays (Fig. 5-69), floating in experimental tanks or at the sea's surface; (iv) compartmented, perforated tubing (Fig. 5-70); (v) planktonkreisels (Fig. 2-136, p. 225), *in situ* kreisels (Fig. 2-143, p. 232), and cages attached to lobster traps (Fig. 5-71). Unless considerable space and sufficient hiding places are provided, only one lobster can be placed in each culture enclosure (prevention of cannibalism). In mass cultures, the individual compartments may be quite small. Acceptable growth is possible even in compartments that are only little larger than the lobster itself. Increased temperatures (e.g. to 20° or 25° C), high water quality, well-balanced diets and frequent feeding result in growth rates about 2 or 3 times as high as in nature. Growth and moulting observed in young males and females of *Homarus americanus* kept in a recirculation system at 20° C are illustrated in Fig. 5-72.

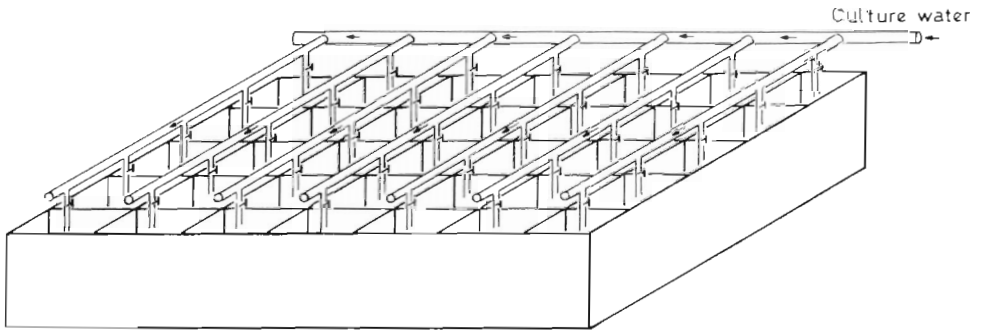

Fig. 5-69: Compartmented culture tray for rearing young lobsters. Each compartment contains 1 juvenile and receives a trickling flow of sea water which drains through the perforated bottom of the half-immersed tray. (Constructed by A. HOLTSMANN; original.)



Fig. 5-70: Rearing of subadult lobsters. Four stacked trays with 12 perforated tubes (5 compartments each) receive a continuous flow of recirculated sea water. (Courtesy of Dr. M. H. CHANLEY. Photograph: PETER WENZEL.)

For mass culturing juvenile *Homarus americanus* (Stage IV to 2.7-cm carapace length), CHANLEY and TERRY (1974) used compartmented, perforated 'modular habitats'. These consist of 55-cm long, rigid polypropylene tubing with small, rectangular perforations, 6 polyethylene dividers, and 6 rubber bands holding the dividers in place. Into the upper part of the tube is cut a 3-cm wide slit to allow access for feeding and handling. Twelve such tubes, each of which accommodates 5 small lobsters in separate compartments, are placed horizontally in trays with recirculating sea water (Fig. 5-70). Tube diameter and compartment length can be adjusted to lobster size.

The cylindrical *in situ* cage developed by SCHNEIDER and ZAHRADNIK (1974) can be readily incorporated into usual commercial lobster operations (Fig. 5-71). It

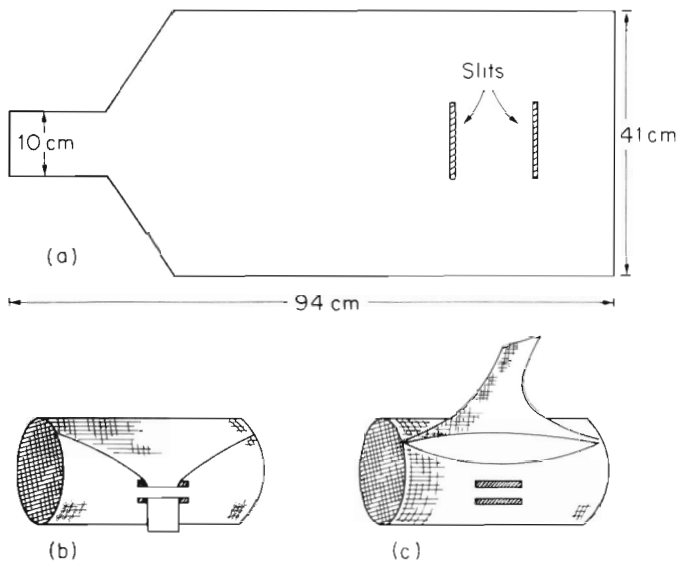

Fig. 5-71: Cylindrical *in situ* cage for rearing young lobsters. (a) Strip of netting used to form the cage; (b) cage closed; (c) cage held open for servicing. (After SCHNEIDER and ZAHRADNIK, 1974; modified; not copyrighted.)

protects the lobster, especially during moulting, and—provided regular feeding is maintained—promises good growth. Further improvements of the *in situ* cage are required, and seem possible, e.g. in regard to reducing cage damage or losses due to wave action or poachers and to improving of management and feeding procedures.

Mating of *Homarus americanus* and *H. gammarus* takes place in spring or summer. Members of both species copulate readily in captivity, even in shallow experimental trays (JATZKE, personal communication). On Helgoland (FRG), *H. gammarus* mated in a small tray with so little water that the male's head was partially exposed to air (Fig. 5-73). Usually, copulation takes place a few hours after the female has moulted. Attracted and excited by a substance released by the female, the male 'tip toes' towards her. Following the first physical contact, both partners touch and

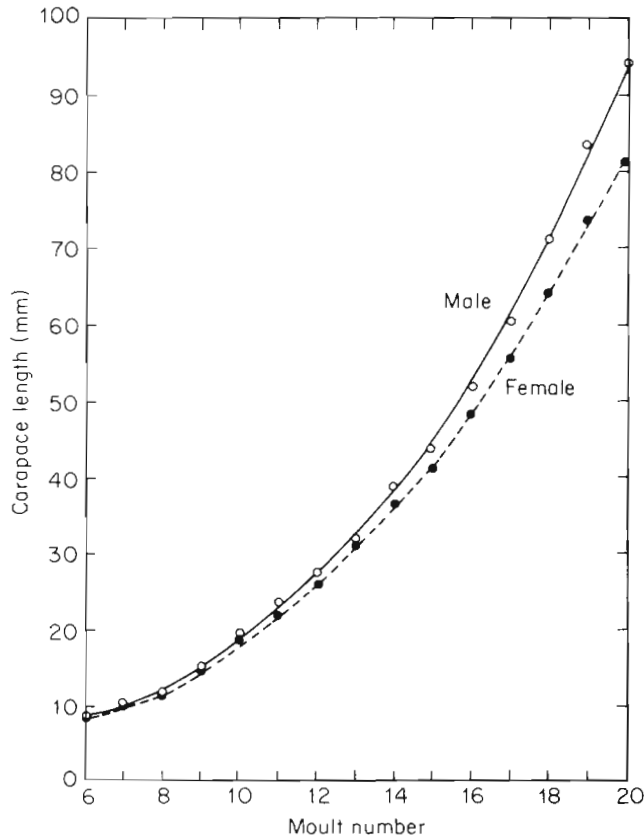

Fig. 5-72: *Homarus americanus*. Growth rates obtained in a closed sea-water system at 20° C. (After SLESEER, unpublished; modified; reproduced by permission of the author.)

stroke each other with their antennae for periods of 5 to 15 mins. Finally, the male slowly crawls on the female and turns her around so that their ventral sides face each other. He then transfers the sperm into the female's receptaculum seminis, located between the bases of the 3rd pair of walking legs. Here, the sperm is stored for about 1 year. Depending on the female's size and age, 4000 to 130,000 black eggs are released, fertilized and cemented by gland secretions to the swimmeret hairs. Under natural climatic conditions, it takes about another year (10 to 11 months) for the eggs to develop. Gradually, their colour changes from black to green to brown. Maximum hatching efficiency and normal larval development require temperatures above 14° to 15° C. According to JATZKE (personal communication), cultured *H. gammarus* females may oviposit in water depths as low as 20 cm. However, under such conditions, the females sometimes raise their body partially above the water surface. This may lead to egg emergence. Pronounced air

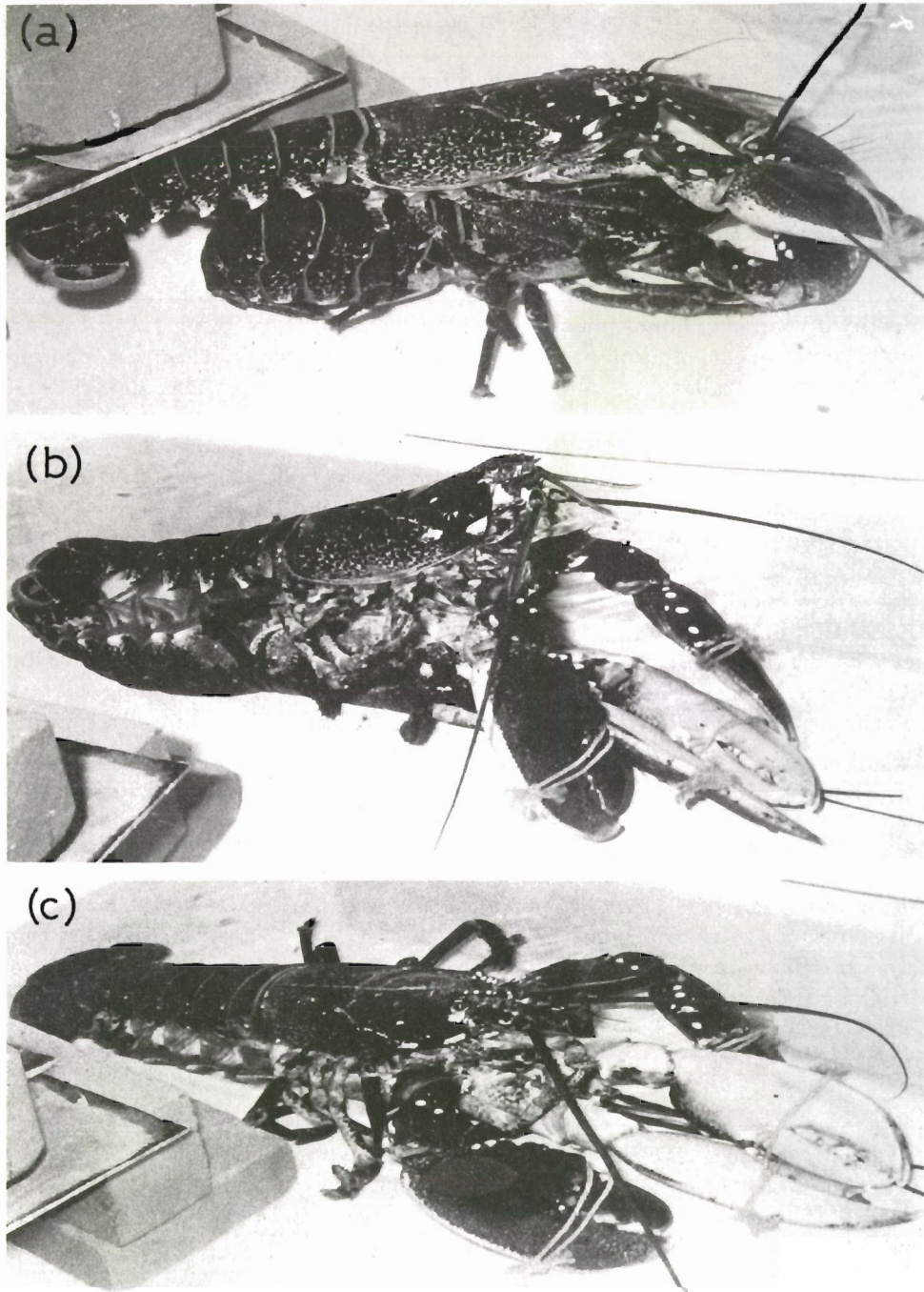

Fig. 5-73: *Homarus gammarus*. With their claws tied, these two lobsters copulate in a shallow tray. Holding her dorsally, the male begins to slowly roll the female over (a). He then mounts her (b, c) and transfers the sperm. In (b) the male's head is raised above the water surface. (Photograph: P. JATZKE.)

exposure of the eggs often causes these to fall off, especially shortly after oviposition.

While lobsters can be bred under laboratory conditions from egg to egg, their slow growth under natural conditions and their long life span (some investigators claim that lobsters can live to be 80 years old) have impeded experimental work on overall growth rates, productivity and population genetics. According to SHLESER (in press), *H. americanus* grows most rapidly at 21° C; at this temperature, lobsters could be raised from larvae to market size in less than two years, compared with 5 to 8 years under natural conditions.

For large-scale commercial lobster production, underwater lobster farms, attended by divers, may hold some promise (KINNE, 1970; BOWBEER, 1971; JATZKE, personal communication). Potential advantages lie in (i) use of natural water supply (no buildings, installations, pumps, filters); (ii) supplementary natural-food supply; (iii) protection from wind and waves. Main disadvantages are (i) need for divers and diving equipment; (ii) pilferage. Important prerequisites for successful operation of underwater lobster farms are a suitable sea area with unpolluted water, accessibility, cheap cages resistant to fouling and corrosion, cheap food and well-planned feeding and management procedures. In 1971, 'spring sales' from an underwater lobster farm in the northwest of Scotland totalled some 11,340 kg of live lobsters (BOWBEER, 1971; see also Chapter 5.2).

In addition to optimizing environmental conditions for maximum growth, some other considerations have increased hopes for working out economically feasible methods of lobster farming in land-based facilities: selective breeding of fast-growing specimens and development of artificial 'growth diets', as well as 'tailor-engineered' culture enclosures and recirculation systems. HUGHES and co-authors (1972) mated selected, fast-growing lobsters. At 22° to 24° C, sexually mature 500-g lobsters could be raised from larvae in less than 2 years. In contrast, it takes 8 years for growing to 500 g under *in situ* temperature conditions in Canadian waters. Analyzing 3 types of culture facilities (stacked trays, raceway, silo), SCHUUR and co-authors (1974) conclude that stacked trays offer the best possibilities. In spite of the optimism of several investigators, it is our opinion that lobsters are likely to remain an expensive delicacy. While, with increasing prices and demand, lobster cultivation could be profitable, lobster farms can hardly help to solve the world's food crisis or to combat malnutrition—a serious problem for millions of people (Chapter 5.2).

Nephrops norvegicus

The Norwegian lobster *Nephrops norvegicus* has been reared from egg to juvenile by FIGUEIREDO and VILELA (1972). From newly caught berried females, eggs in advanced stages of development were gently removed, washed and transferred to 0.6-mm-mesh hand nets. These were placed in 400-ml beakers with filtered, well-aerated sea water. The sea water was renewed at 2-day intervals and antibiotics were added daily to counteract bacterial infection. Optimum temperature for incubation and survival of larvae ranges from 11° to 14° C. Post-larval growth is very slow at this temperature; after 3 months (3 moults), the postlarvae had attained a total length of 18 mm. Optimum salinity for incubation is about 38‰;

however, hatched larvae did not seem to be significantly affected by other test salinities, i.e. 33, 35 and 40‰S. If no suitable food is provided, freshly hatched larvae become cannibalistic. Nauplii of *Artemia salina* proved to be insufficient, even if supplied in great quantities. The most satisfactory food for larvae was living eggs of *Crangon crangon*; postlarvae received ground soft parts of bivalves (cockles and mussels).

Spiny and Spanish Lobsters (Scyllaridae)

Sea-food delicacies as the true lobsters, spiny lobsters and Spanish lobsters usually have more complex life cycles, but their reproductive potentials (egg number, growth rates, natural rates of survival) tend to be higher. Single females have been reported to produce from 40,000 to 4 million eggs. Glued to the female's ventral side, the viscous sperm fluid quickly hardens at its surface. Upon oviposition, the female breaks the hardened surface with her legs and thus allows the spermatozoa to fertilize her eggs. These then become firmly attached to the swimmerets, where they develop and hatch. During development, the eggs' colour changes from orange to brown; shortly before hatching, the eggs are almost colourless.

Spiny and Spanish lobsters produce phyllosoma, puerulus, nisto or pseudibaccus larvae (Table 5-50). The planktonic phyllosomas (Fig. 5-74) float horizontally with their legs extended. After several moults, the puerulus stage is attained—an intermediary phase between pelagic and bottom life. Upon moulting, the puerulus metamorphoses into a 2-cm long juvenile and remains at the bottom. Still transparent, 1 to 3 additional moults are required before the typical red-brown colour of the adult is acquired (ONG, 1967). Mortality due to predation is usually high at all stages, and cannibalism may occur if foods containing sufficient amounts of calcium are not available. Spiny lobsters may scavenge, but prefer a large variety of fresh foods such as worms, other crustaceans, molluscs and fishes.

The scyllarids *Ibacus ciliatus*, *I. novemdentatus*, *Parribacus antarcticus* and *Scyllarus bicuspidatus* have been hatched in Japanese laboratories, but could be maintained for only a few days. *Scyllarus americanus*, however, has been cultured successfully from egg to metamorphosis within 32 to 40 days (25° C, 23 to 39‰S) by P. B. ROBERTSON (quoted in: BARDACH and co-authors, 1972). ROBERTSON offered his sand lobsters an exclusive diet of *Artemia salina* nauplii.

The Bermuda spiny lobster *Panulirus argus* has been maintained in large indoor concrete tanks by SUTCLIFFE (1957). The tanks received running sea water and the spiny lobsters were well fed every two days with whole minnows or minnow pieces. Cultured specimens did not grow as well as those recently brought in from the field. Hence, culture conditions must be considered suboptimal. Near Bermuda, *P. argus* grow from about 6-mm carapace length to about 90 mm (sexual maturity) within 3 years. Moulting and growth rates under laboratory conditions have also been studied by TRAVIS (1954).

Panulirus homarus were kept in glass aquaria, supplied with running sea water (27° to 30° C) and shelters made of rocks or pieces of asbestos (THOMAS, 1972). The lobsters received a daily diet of clams and pieces of small fish (no details available). Average increase in carapace length per moult was 4 to 9 mm, with an annual length increase of 30 mm in the male and 17 mm in the female. These values are in general

agreement with those obtained by TRAVIS on *P. argus* and LINDBERG (1955) on *P. interruptus*. As in many other crustaceans, ecdysis occurs at night.

Phyllosoma larvae of *Panulirus* species—and of other scyllarid decapods—are difficult to rear. A major problem is to find adequate food sources, especially for

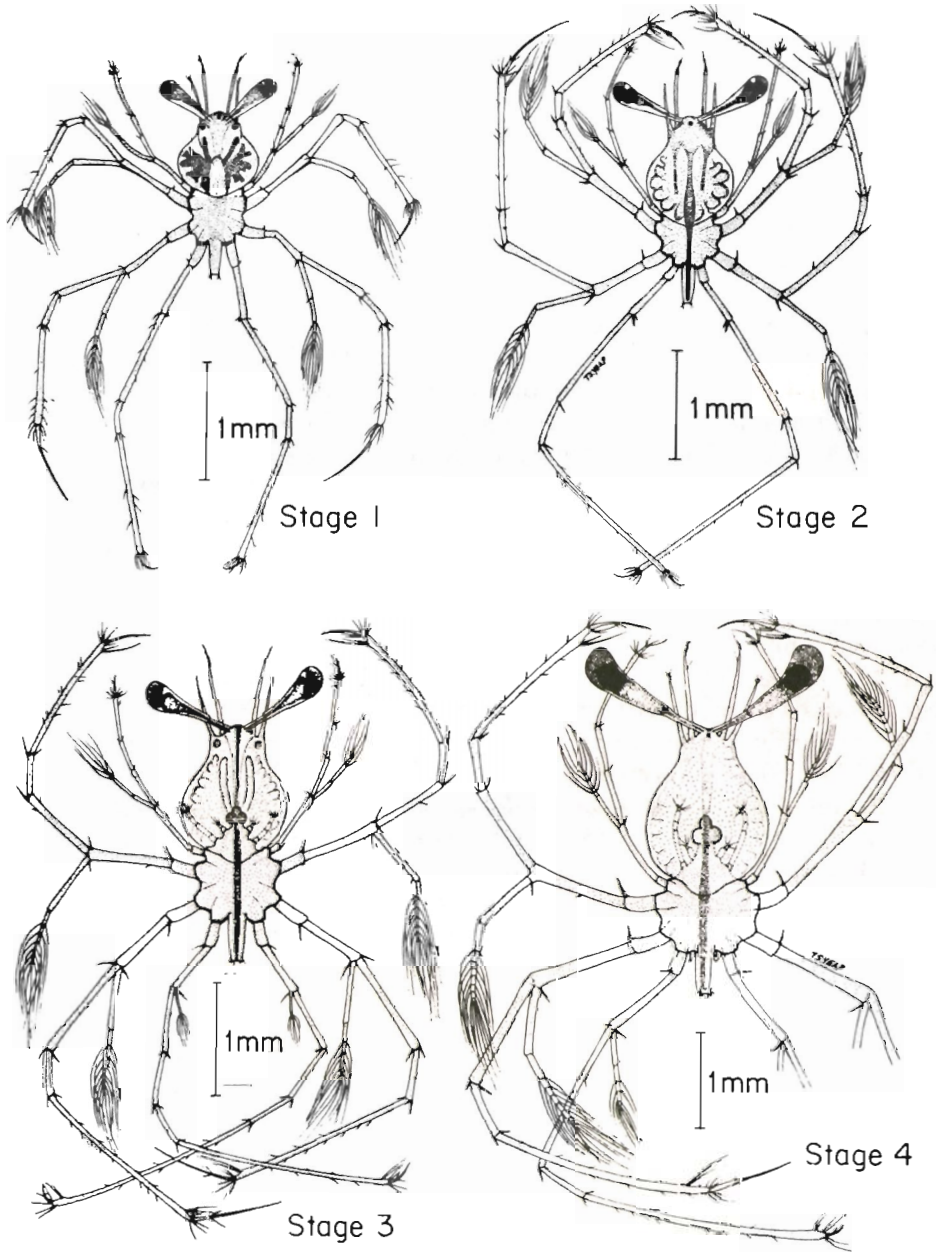

Fig. 5-74: *Panulirus polyphagus*. Dorsal view of phyllosoma stages 1 to 4. (After ONG, 1967; reproduced by permission of Malaysian Agricultural Journal.)

the larger phyllosomes. Attempts to develop artificial food for phyllosoma larvae have, thus far, failed. DEXTER (1972) presents details of the method (based on ROBERTSON, 1968) employed for cultivating *P. interruptus*. She used closed systems (Fig. 2-155, p. 241) and planktonkreisels (Fig. 2-136, p. 225). DEXTER collected offshore sea water and filtered it through a Buchner funnel. The culture water was extensively treated and maintained at 20° or 25° C. Berried females were kept in running-sea-water tanks and fed flesh of *Mytilus* sp. DEXTER followed the development of about 1800 phyllosomes, placed singly in small Plexiglas containers. In the larvae, neither gonad tissue of *Mytilus* sp. nor eggs of *Lytechinus* sp. and *Tubifex* sp. tissue supported continued growth, but fish larvae and nauplii and metanauplii of *Artemia salina*, as well as pieces of ctenophores and chaetognaths provided acceptable food (Table 5-51).

Phyllosomes of *Panulirus interruptus* raised by DEXTER (1972) in mass culture in a planktonkreisel survived for a maximum of 20 days. Maximum mortality was high under all conditions tested. Approximately 50% of all phyllosomes died at each moulting step. Maximum length of larval life, 114 days, was recorded in phyllosomes living in individual culture enclosures. Isolation of single individuals promoted moulting and prevented entanglement of larvae. There is considerable variation in moulting frequency among larval batches hatched in different seasons.

Panulirus japonicus and related species have been raised in Japan from hatchlings over 5 to 10 moults. Other *Panulirus* species cultured for brief periods or with limited success include *P. elephas*, *P. inflatus* and *P. longipipes* (BARDACH and co-authors, 1972).

The early larval development of *Panulirus polyphagus* has been investigated by ONG (1967). He kept berried females in concrete troughs (3 × 0.8 × 0.6 m deep), filled to a depth of 40 cm with aerated sea water (ca 30‰S), supplied from a reservoir in which the water pumped in from the sea had been allowed to settle for about 2 days (food: live bivalves; complete culture-water exchange every 3 days). Freshly hatched phyllosoma larvae were scooped up with a bowl and transferred to culture enclosures: circular plastic vessels with a diameter of 24 cm, filled to a depth of 5 cm with sea water of 25° to 30° C. First, about 30 larvae were placed in each basin, later—fewer individuals. Newly hatched nauplii of *Artemia salina* and ready-to-hatch *A. salina* eggs served as food. The culture enclosures were not provided with aerators, but exposed to draughts which kept the water surface in gentle motion and thus provided aeration. The culture water was changed daily. ONG reports considerable variation in the timing of moults in different individuals. Minimum intermoult periods were 9 to 10 days for the first two moults and 11 to 12 days for the third moult (see also SAISHO, 1966a, b). The first four instars of *P. polyphagus* are illustrated in Fig. 5-74.

The scyllarid lobster *Scyllarus americanus* has been successfully reared through several phyllosoma stages by ROBERTSON (1968).

Crabs: General Aspects

Many decapods, notably crabs, have been cultivated with the major aim of investigating sequence and structure of life-cycle stages. The culture methods employed by hundreds of investigators are characterized by simplicity and a high

degree of uniformity. Hence, a detailed, exhaustive documentation is not necessary. In most cases, crab larvae have been obtained from egg masses recovered from ovigerous females or by allowing laboratory maintained females to release their larvae.

Rearing of crab larvae has been pioneered by LEBOUR (1927, 1928a, b), HART (1935a, b, 1937), COFFIN (1958), COSTLOW and BOOKHOUT (1960a, b) and IRVINE and COFFIN (1960). LEBOUR'S attempts to raise brachyuran larvae in small containers with stagnant sea water were favoured by the fact that appropriate food (larvae released from cultured members of the genera *Ostrea*, *Teredo*, *Pomatoceros* and *Echinus*) was readily available. HART used larvae of *Ostrea lurida* as food. COSTLOW and BOOKHOUT presented the first more detailed descriptions of culture methods. Their papers have guided most later investigators who studied decapod larval stages under laboratory conditions.

COSTLOW and BOOKHOUT (1960a, b) hatched larvae (e.g. of *Callinectes sapidus*, *Hepatus epheliticus*, *Menippe mercenaria*, *Pilumnus sayi*, *Portunus gibbesii*, and *P. sayi*) from egg masses removed from ovigerous females. The egg-bearing maternal pleopods were severed and transferred into small bowls containing sea water. Strands of eggs were then cut from the pleopods with fine scissors, and carefully dissociated with glass needles into groups of about 100 to 1000. After washing, the eggs were placed in compartments of plastic boxes which contained about 20 ml of (filtered) sea water (surface area about 9 cm²) and 200,000 units of penicillin. The most frequently used type has 18 rectangular compartments per box, each having a total volume of about 100 ml. All boxes are fitted with lids and can be conveniently stacked. Placed on an Eberbach variable speed shaker (110–120 min⁻¹), the boxes were exposed to 22° or 25° C in a culture cabinet. Upon hatching, some zoeae were transferred to separate box compartments and offered recently hatched *Artemia salina* and fertilized eggs of *Arbacia* sp. as food. Fresh food was added daily and zoeae were transferred to freshly filtered sea water every second day.

Since COSTLOW and BOOKHOUT'S papers appeared in 1960, about 150 contributions have been published to this date that involve cultivation of decapod crabs. Almost all are characterized by (i) repetition, sometimes with minor modifications, of basically the same culture methods; (ii) lack of details required to evaluate the results obtained in ecological terms. The primary aim of most investigators has been to describe the larval development. Very few papers deal with ecological perspectives such as responses to environmental factors, metabolic efficiencies, productivity or nutritional dynamics.

Most investigators used batch cultures, replacing part or all of the culture water at intervals, usually every 2 or 3 days. Running sea-water systems have been employed only recently (e.g. SASTRY, 1970a, b). Aiming at mass cultivation of brachyuran larvae under controlled conditions, SASTRY developed the culture systems illustrated in Figs 2-152 (p. 239) and 2-153 (p. 240).

Cancer irroratus

Following the procedure of previous investigators, SASTRY (1970b) removed egg masses from freshly collected ovigerous females of *Cancer irroratus*, washed the egg masses several times with filtered sea water containing streptomycin, 2 ml l⁻¹

(stock solution: 2 g l^{-1}), and placed isolated egg strands in compartments of plastic boxes containing 50 ml of streptomycin-treated sea water (15° C , 30‰S). The eggs were incubated under a photoperiod of 14 hrs light (fluorescent lamp) at 10° , 15° , 20° C . Immediately after hatching, larvae were removed for mass cultures and for experiments. Freshly hatched *Artemia salina* nauplii, provided daily, served as only food source. Eggs were also hatched by maintaining ovigerous females in battery jars containing 7 l of sea water (15° C , 30‰S); however, although large numbers of larvae were obtained, this latter method caused high mortalities. The first zoeal stage of *C. irroratus* is positively phototactic under normal light conditions. Mortalities were high (possibly in part due to cannibalism) especially during transition from final zoea to megalops (Table 5-71).

Table 5-71

Cancer irroratus. Survival of larvae and young crabs in a mass-culture system (Fig. 2-152, p. 239). Photoperiod: 14 hrs light; 15° C ; 30‰S ; food: *Artemia salina* nauplii (After SASTRY, 1970b, reproduced by permission of the author)

Culture system	Volume of sea water per culture container (l)	Flow rate	Turnover rate	Initial number of larvae	Megalops		Crabs	
					% survival	days	% survival	days
Original system (SASTRY, 1970a)	10	80 ml min^{-1}	0.5 times hr^{-1}	4,800	1.3	28-43	0.06	43-58
Advanced system (SASTRY, 1970b)	25-27	2 l min^{-1}	3 times hr^{-1}	26,000	9.61	30	0.24	49

Carcinus maenas

Several workers have raised larvae of the euryplastic *Carcinus maenas*. WILLIAMS (1968), for example, raised larval stages in batches of 20 in 400-ml beakers at 12° C (food: *Artemia salina* nauplii, *Dunaliella primolecta*, *Micromonas pusilla*, *Hemiselmiss rufescens*, *Ditylum brightwellii*, *Phaeodactylum tricornutum*, *Prorocentrum micans*). The sea water used in his cultures was first pasteurized at 60° C , then treated with penicillin, streptomycin sulphate (50 I.U. ml^{-1}) and enriched with Erdschreiber nutrients. DRIES and ADELUNG (in press) showed that *C. maenas* larvae can be raised exclusively on *A. salina* nauplii. They report preferred larval hatching during darkness and claim that 15° C is optimal for zoeal growth, but 17.5° C for megalopa growth.

Adult *Carcinus maenas* are easy to cultivate. Often used for demonstrations or experiments, they thrive on a large variety of foods, e.g. annelids, meat of crustaceans, molluscs such as *Mytilus edulis* or *Mya arenaria*, fish meat and on feeds developed for shrimp, trout, catfish and for other commercially cultivated crustaceans and fishes.

Emerita talpoida

Larvae of the sand crab *Emerita talpoida*, obtained from ovigerous females were placed, in groups of 10, in 10-cm finger bowls with glass-wool-filtered sea water (30° C) sterilized with 200,000 units of penicillin l⁻¹ (REES, 1959). Other larvae were reared in finger-bowl mass cultures containing about 200 individuals each. The larvae were pipetted each day into clean, filtered sterilized sea water. *Nitzschia* sp. and newly hatched *Artemia salina* were added daily as food source. The average length of time required to pass the planktonic stages was 28 days. Developmental stages of *E. talpoida* are illustrated in Fig. 5-75.

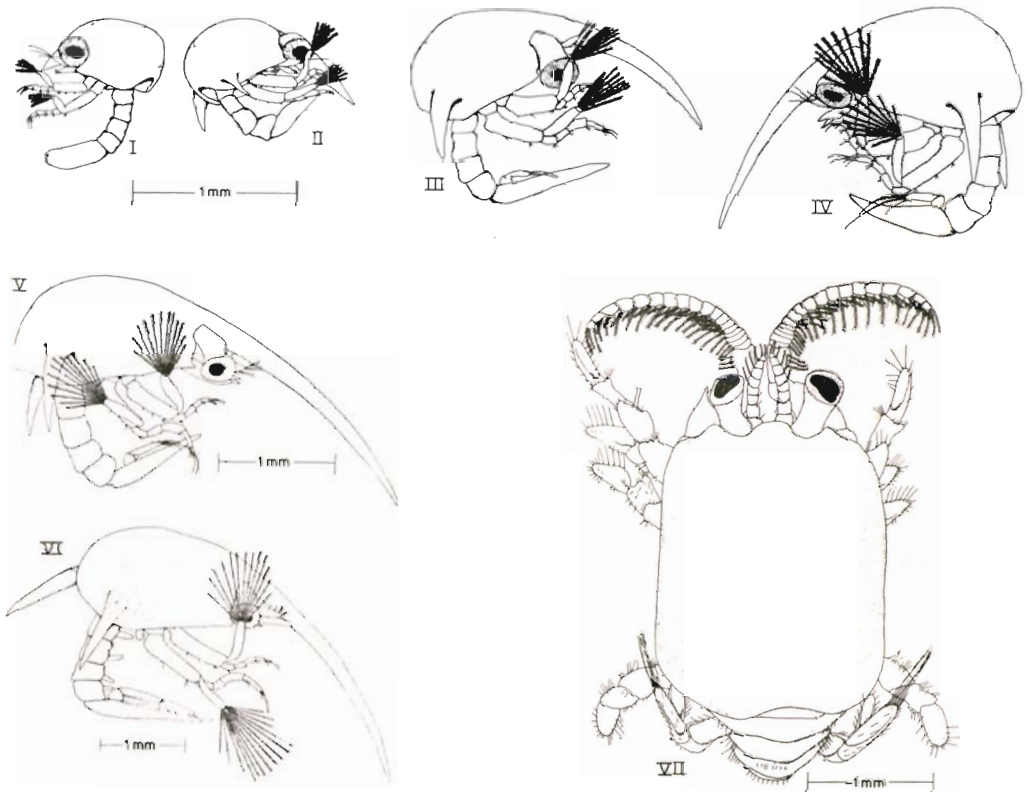

Fig. 5-75: *Emerita talpoida*. Zoecal stages I to VI and megalops (VII). (After REES, 1959; reproduced by permission of the *Biological Bulletin*.)

Menippe mercenaria

The stone crab *Menippe mercenaria* has been cultivated by MOOTZ and EPIFANIO (1974; see also MOOTZ, 1973) under a photoperiod of 12 hrs light at 25° C in 30‰ S. The larvae were transferred daily to freshly filtered sea water and fed in excess newly hatched nauplii (5 ml⁻¹) of *Artemia salina*. Feeding rates are illustrated in Fig. 5-58, energy budget and energetic efficiencies for each zoecal stage and the megalops are presented in Table 5-68 (p. 839).

Pagurus Species

Effects of reduced salinities on the larval development of *Pagurus longicarpus* have been studied by ROBERTS (1971a). The mortality of isolated megalopae was unaffected by the presence or absence of empty clean shells of *Bittium* sp. (used as 'house' by juvenile and adult crabs). However, in mass culture, megalopae exhibited a higher mortality without shells because of cannibalism (ROBERTS, 1971c). After 24 hrs, 50% of the megalopae had entered a shell if available; after 48 hrs, up to 93%. A few megalopae which failed to enter a shell did so immediately after moulting to the juvenile instar. The moulting rhythm of larvae and juveniles was not significantly affected by the presence or absence of mollusc shells (see also p. 826).

Salinity responses of cultured *Pagurus longicarpus* larvae revealed avoidance reactions to reduced salinities (ROBERTS, 1971b). In discontinuity cylinders (similar to those used by HARDER; see Volume I: KINNE, 1971, pp. 969-973), all zoeal instars attempted to escape salinities of 20‰ or less, which are well within the salinity ranges permitting complete juvenile development. Escape from low salinities has also been demonstrated in newly hatched larvae of *Homarus americanus* (SCARRATT and RAINE, 1967) and in larvae of other crustaceans (Volume II: CREUTZBERG, 1975, p. 595).

Larvae of *Pagurus marshi* have been obtained by PROVENZANO and RICE (1964) from a gravid female kept in running sea water. A total of 30 larvae were trapped in a series of jars connected by siphons, and transferred singly into compartments of a plastic tray with approximately 50 cm³ of filtered sea water. The food consisted of freshly hatched *Artemia salina*. The *P. marshi* larvae were reared both under natural daylight (avoiding direct sunlight) and in artificial illumination from fluorescent lamps (photoperiod: 14 hrs light; 20° to 26° C; 35 to 36‰S).

Comparable methods have been employed for raising larvae of *Pagurus variabilis* at 8° to 10° C by SAMUELSEN (1972).

Rhithropanopeus harrisi

Using the artificial sea waters 'Instant Ocean' and 'Utility Seven Seas Marine Mix' (Chapter 2, p. 29), SULKIN and MINASIAN (1973) raised larvae of the euryplastic crab *Rhithropanopeus harrisi* (syn.: *Heteropanope tridentatus*) from hatching to the megalopa. They compared the ability of the two artificial sea waters and of natural sea water (3‰; 11‰S) to support larval development. In all media, high survival rates were obtained from Zoea I to Zoea IV (Fig. 5-76). Statistical analyses revealed no significant differences due either to the medium used or to salinity. The reason for the sudden increase in mortality at the megalopa stage is unknown. Rate of larval development was slowest in 3‰S 'Instant Ocean' and in 3‰S 'Utility Seven Seas Marine Mix'; it was faster in 11‰S 'Utility Seven Seas Marine Mix' and still more so in 3‰S natural sea water.

FRANK and co-authors (1975) raised *Rhithropanopeus harrisi* larvae in 'Instant Ocean' under a photoperiod of 14 hrs light (20° C; 15‰S) with *Artemia salina* nauplii as sole food source. The authors report on biochemical changes (protein, total lipid, alkaline phosphates, glutamic oxaloacetic transaminase) during larval development.

As many other crabs, adult *Rhithropanopeus harrisi* can be kept under laboratory conditions without difficulty. They feed on a large variety of animals, including annelids (*Enchytraeus albidus*, *Lumbricus terrestris*) and meat of a large variety of

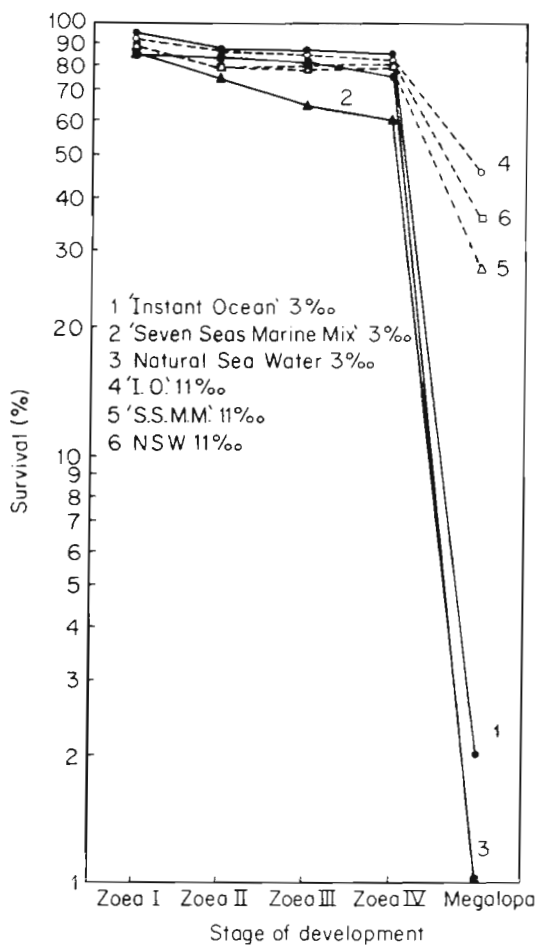

Fig. 5-76: *Rhithropanopeus harrisi*. Survival of larvae from hatching through megalopa in 6 different media. (After SULKIN and MINASIAN, 1973; modified; reproduced by permission of Biologische Anstalt Helgoland.)

crustaceans, molluscs and fishes, as well as on benthic algae such as *Enteromorpha intestinalis* and *Ulva lactuca* (KINNE and ROTTHAUWE, 1952).

Scylla serrata

The early developmental stages of *Scylla serrata* and its post-larval life history have been studied by RAJA BAI NAIDU (1955) and ONG (1966a, b). Following preliminary pond-rearing experiments (ESCRITOR, 1970; RAPHAEL, 1970; VARIKUL

and co-authors, 1970), BRICK (1974) examined the effects of water quality, antibiotics, presence of *Chlorella* sp. and food on survival and development of larval *Scylla serrata*. While water filtration and ultra-violet disinfection exerted no significant effects, an antibiotic mixture (carbonate-buffered penicillin-G, 40 ppm, + polymyxin-B sulphate, 10 ppm) enhanced premetamorphic zoeal survival. However, the mixture may have been detrimental to the megalopae. The presence of *Chlorella* sp. (final concentration approximately 5×10^3 cells ml⁻¹) stimulated metamorphosis to the megalopa stage. After testing 4 different food sources (*Artemia salina*: nauplii and adults; *Brachionus plicatilis*; copepod plankton), BRICK concludes that *A. salina* nauplii gave the best results. *B. plicatilis* and copepods failed to support the zoeae to the onset of metamorphosis. For zoeal survival, 10 nauplii ml⁻¹ was optimal; metamorphosis was enhanced as the density increased to 16 nauplii ml⁻¹; the megalopae survived better and developed faster to the crab stage at the higher nauplii densities provided. BRICK conducted his experiments on zoeae at 2.69 klux, 21° to 23° C, and 33 to 34.5‰S (27 to 28‰S for megalopae). Reduced salinities enhanced megalopa survival. Apparently, in nature, the females migrate into coastal areas with low salinities during egg development and hatching.

The tolerances of the first zoeal stage of *Scylla serrata* to 61 different temperature-salinity combinations have been analyzed by HILL (1974). Temperatures above 25° C and salinities below 17.5‰ caused high mortality. The larvae become inactive below 10° C, but tolerate temperatures down to 5° C. HILL suggests that 10° C represents the lower thermal limit, and that female crabs which migrate to sea for gamete release do not enter water below 12° C. In his 1975 paper, HILL reports on abundance, breeding and growth of *S. serrata* in two South African estuaries.

Other Decapod Species

Synopses are available on *Heterocarpus reedi* (BAHAMONDE and HENRIQUEZ, 1970), *Pandalus jordani* (DAHLSTRÖM, 1970; see also p. 851), *P. montagui* (SIMPSON and co-authors, 1970), *P. platyceros* (BUTLER, 1970), *Parapenaeopsis styliifera* (VEDAVYASA RAO, 1970) and *Solenocera indica* (KUNJU, 1970). Success in rearing larvae of the 5 decapods *Lepidopanopeus bellus*, *Petrolisthes eriomereus*, *Pagurus hirsutiusculus*, *Hemigrapsus oregonensis* and *Pugettia gracilis* on a diet of *Artemia salina* nauplii has been reported by FORSS and COFFIN (1960). In these developmental studies, mortalities were usually high. Immature adults received minced muscle of *Littorina* sp. as food source. Essentially the same method was used for rearing early stages of *Fabia subquadrata*, a commensal crab isolated from the mantle cavity of the mussel *Modiolus modiolus* (IRVINE and COFFIN, 1960). Growth rates of captive *Jasus lalandei* have been studied by FIELDER (1964).

Larvae of the commercially important king crab *Paralithodes camtschatica* can be reared in stagnant sea water (Table 5-72). Mortality rates decreased after the 4th zoea. The glaucothoe developed into the first postlarva almost without any losses, and raising of subadults does not seem to pose severe problems. For early stages, nauplii of *Artemia salina* provide a good food source (SATO, 1958).

Eggs of meso- and bathypelagic decapods (*Acantheephyra* spp., *Ephyrina ombango*, *Meningodora* spp., *Notostomus auriculatus*, *Oplophorus spinosus*,

Plesionika martia, *Systellaspis* spp.) have been removed and incubated *in vitro* at 12° C by HERRING (1974). In general, species with large eggs exhibited a longer embryonic period than those with small eggs.

Table 5-72

Paralithodes camtschatica. Duration of larval development (days) in cultured individuals (After SATO, 1958, compiled from the sources indicated; reproduced by permission of Director of the Hokkaido Regional Fish. Res. Lab.)

Larval stage	MARUKAWA*	SHIMIZU*	SATO and TANAKA* SATO (1958)
1st zoea	21 days (3.8 ~ 6.1° C)	24 days (2.0° C)	7 days (9.0° C)
2nd zoea	14 (6.8° C)	12 (5.0° C)	10 (8.9° C)
3rd zoea	15 (7.5 ~ 7.7° C)	14 (6.9° C)	9 (9.2° C)
4th zoea	14 (7.8° C)	14 (5.5° C)	9 (11.3° C)
Glaucothöe	20	—	12 (14.9° C)
Total to Glaucothöe stage	64	64	35
Total to young adult stage	84	—	47

* See SATO (1958) for references.

Malacostraca as Assay and Food Organisms

Among the different species and life-cycle stages of malacostracans are numerous representatives which qualify as assay and food organisms. Larvae of natantians and reptantians, mass-hatched from fertilized egg batches of individual females, hold considerable promise. They are small, of comparable age and genetic backgrounds, and can be accommodated in large numbers in relatively small culture enclosures.

Among the natantians, numerous species have been successfully accommodated in cultures and are now available for assay and nutritional purposes. Among the reptantians, several crabs have already been used as assay organisms, for example, *Uca pugilator* (VERNBERG and VERNBERG, 1972), *Cancer irroratus* (THURBERG and co-authors, 1973) and *Eurypanopeus depressus* (COLLIER and co-authors, 1973). THURBERG and co-authors exposed *C. irroratus* to various concentrations of copper (cupric chloride) and cadmium (cadmium chloride). Copper caused blood-serum isosmoticity, especially at lower salinity levels; cadmium elevated blood-serum osmolality and depressed gill oxygen consumption. COLLIER and co-authors

further report decreased gill oxygen consumption with increasing cadmium levels for *E. depressus*.

The effects of pesticides, especially of juvenile hormone (JH) and its mimic methoprene, on crustaceans have been studied by GOMEZ and co-authors (1973), MIURA and TAKAHASHI (1973), RAMENOFSKY and co-authors (1974), COSTLOW (1976) and CHRISTIANSEN and co-authors (in press).

These few statements and examples must suffice here to document the considerable potential of cultured malacostracans as assay and food organisms (see also Volume V).

Malacostraca: Conclusions

Mysidacea, Isopoda and Amphipoda have usually been cultivated in beakers, finger bowls or Boveri dishes—often in non-running sea water, replaced at regular intervals. For planktonic forms, specific equipment, such as the planktonkreisel (Fig. 2-136, p. 225), has been used. Many representatives of these groups are omnivorous; others accept a large variety of small animals and animal tissues. No studies have come to the reviewer's attention that would testify to a high degree of technical difficulties involved in cultivation. However, some forms are known, or expected, to exhibit specific environmental and/or nutritional requirements.

Euphausiacea have, thus far, resisted all attempts at egg-to-egg cultivation. Most of these open-ocean dwellers are suspension feeders. While early developmental stages do not feed, the calyptopis and later stages accept a variety of unicellular algae and nauplii of *Artemia salina*. Presumably, smaller zooplankters, such as rotifers or copepods, would be more suitable than brine shrimp larvae. Essentials in euphausiid cultivation are (i) careful collection and handling; (ii) use of habitat water and frequent water renewal; (iii) avoidance of pronounced changes in environmental factors and of crowding; (iv) low illuminance or darkness; (v) use of black-walled, smooth, round, covered culture enclosures; (vi) indirect aeration, i.e. avoidance of contact with air bubbles.

Decapoda Natantia (shrimps and prawns) have attracted considerable attention. Kept in aquaria, raceways, ponds and related medium-sized culture enclosures, about 45 natantian species have been cultured thus far, mostly with the aim of developing suitable techniques for commercial cultivation. The major problems of shrimp and prawn farming include: (i) supply of sufficient quantities of seedlings (larvae, juveniles); (ii) provision of adequate, inexpensive food; (iii) working out of a dietary time-table which parallels the changing food requirements of successive developmental stages; (iv) control of essential environmental factors; many natantians are assumed to have rather narrow thermal limits during their early ontogenetic development; (v) selection of rapidly growing forms with high tolerances to the stresses of domestication (stock improvement); (vi) control of reproduction and diseases (see also Chapter 5.2).

Nutritional studies on cultured natantians have yielded first insights into food requirements and produced encouraging results in regard to the development of pelleted dry foods. However, attempts to provide cheap, readily available food sources that sustain maximum growth rates have encountered difficulties. The best results have been obtained with diets that contained amino-acid compositions

similar to those of the natantians cultured. In other words, shrimp grow best when they eat shrimp. At often low food-conversion efficiencies, feeding shrimp with shrimp is a poor proposition for commercial cultivation and for increasing the world annual food-protein production. Some investigators hope that it will be possible in the future to develop diets with a defined, optimum amino-acid composition by making use of low-priced organic waste materials.

The provision of adequate food for larvae still constitutes a major stumbling block. However, several natantians have an abbreviated development or possess larvae which have a large yolk supply and require no, or only little, feeding prior to metamorphosis. Such species are the obvious choice for farming efforts. Like several other crustaceans, many *Natantia* develop through a primarily herbivorous phase in early larvae to primarily carnivorous feeding in later stages.

While a few natantians seem to develop and grow equally well on dry and live foods, in many cases, best growth has been reported with live foods such as *Artemia salina* or meat of freshly killed animals (e.g. short-necked clams, mussel, squid, crustaceans, fishes). Significantly, dry-food diets, supplemented weekly with small amounts of live food, have yielded growth rates comparable to those typical for live-food diets. Dry-food/live-food mixtures which produce maximum growth at high efficiencies of food conversion remain to be determined. The potential importance of fresh plant food as dietary supplement deserves attention. The availability of dry-food diets with proper amounts of vitamins and mineral mixtures and with small supplements of live food could revolutionize natantian mass cultivation.

Aside from a paper by HOOD and MEYERS (1973), we know nothing about microbial participation in digestive activities of penaeids. Within the shrimp's digestive tract, chitinase activity is correlated with ingestion of chitin and concomitant with an increase in the local chitinoclastic bacterial biomass. According to HOOD and MEYERS, bacteria may serve as a direct source of nutrients for shrimp in addition to acting as producers of digestive enzymes.

Several investigators have established that benthic natantians, such as pink and brown shrimp, seek protection in sediments—e.g. from light and predators, possibly also from temporal, extreme fluctuations in temperature and salinity. Especially during and after moulting, survival depends on the availability of some kind of protective covering, including the substratum. It is surprising, therefore, that SICK and co-authors (1972) report no significant differences in survival rates of penaeid shrimp kept in bare-bottom tanks versus controls kept in tanks with a sand-shell substratum or with brick subdivisions. Further investigations are necessary to elucidate the substrate requirements of captive natantians.

In spite of success in cultivation, natantians raised under controlled conditions are likely to remain high-priced delicacies. Farming projects seem economically feasible in tropical or sub-tropical countries with large areas of low-cost coastal land, unpolluted waters and low-cost labour. Improvements in culture techniques are desirable and seem possible: e.g. better integration of seed production, fattening, marketing; development of dry-food formulae and of pelleted feeds with known chemical gross composition and with a long shelf life; automatic feeding procedures.

Decapoda Reptantia (lobsters and crabs) have been cultured by (i) experimental ecologists interested in environmental tolerance, osmoregulation, non-genetic adaptation, embryonic and larval development, growth, reproduction and nutri-

tion; (ii) taxonomists, investigating sequence and structure of successive life-cycle stages; (iii) physiologists concerned with metabolic rate, endocrinology and biochemistry; (iv) ethologists; and (v) mariculturists.

Major problems encountered in lobster cultivation are: (i) The voracious appetite and territorial behaviour of larvae, subadults and adults which often result in excessive cannibalism. The only sure way to avoid cannibalism is isolation (1 individual per culture enclosure). In mass cultures, such isolation considerably increases service and space requirements. Other, if less effective, counter measures include continuously high food supply, sufficient hiding places and very low population densities, and claw-tying (Fig. 5-73); in larvae, in addition to high feeding levels, heavy water movement and darkness reduce cannibalism and, hence, mortality. Whether aggression and cannibalism can be diminished by endocrinological means, drugs or surgery remains to be investigated. (ii) The slow rate of growth at normal habitat temperatures and the long life span of up to 70 years or more. Elevated temperatures help to accelerate growth and to shorten generation time. (iii) The moults which—as in other crustaceans—cause increased susceptibility to disease, injury and metabolic malfunctioning (counter measures: culture-water disinfection, careful water management and protection from predators).

General considerations for reducing the problems encountered in lobster cultivation include: (i) Optimization of environmental factors (e.g. light, temperature, salinity, dissolved gases, space). Optimal control theory has been employed, for example, by BOTSFORD and co-authors (1974) for determining the best thermal conditions for a lobster farm (see also RAUCH and co-authors, 1974, and SHLESER, in press). (ii) Efficient water-quality management (Chapter 2). (iii) Provision of low-cost diets which meet all basic nutritional requirements, and feeding schedules that harmonize with the lobsters' diurnal activity patterns. (iv) 'Tailor made' culture enclosures. (v) Control of diseases such as bacterial or fungal infections in closed culture systems (sterilization of water and food added), and by adequate nutrition. Individuals under environmental or nutritive stress may become susceptible to pathogens which otherwise would not be able to establish themselves.

High prices and increasing demand may render lobster farming profitable. Reviewing the prospects of mass-rearing juvenile rock lobsters in Australia, CHITTLEBOROUGH (1974) concludes that there is no technical barrier. Under optimal environmental conditions, 2-year-old western rock lobsters were reared to market size in an aquarium in less than half the time required in the sea. However, like natantians, lobsters presumably will remain a sea food that only few people can afford (Chapter 5.2).

The principles of rearing crab larvae may be summarized as follows (COSTLOW and BOOKHOUT, 1960a, b): (i) Remove egg masses from ovigerous females (cut off egg-bearing pleopods) and transfer into bowls with sea water. (ii) Cut off strands of eggs and carefully subdivide these with fine glass needles into groups of 100 to 1000. (iii) Wash eggs and accommodate them in compartmented boxes, each containing 20 ml of filtered sea water and 200,000 units of penicillin. (iv) Place boxes on a shaker, and provide temperature control as well as suitable food rations (e.g. nauplii of *Artemia salina* and fertilized eggs of *Arbacia* sp.). (v) Transfer zoeae to culture enclosures with freshly filtered sea water. (vi) Alternatively, collect larvae from ovigerous females allowed to incubate their eggs until hatching. The larvae

are accommodated in culture dishes (culture-water renewal every second day), rotors (Fig. 2-145, p. 233), compartmented trays (Fig. 2-154, p. 241), or in culture systems with running water (e.g. Figs 2-136, 2-138, 2-139, 2-140, 2-142, 2-143, 2-144, 2-146, 2-147, 2-149, 2-152, 2-153).

The diets offered to decapod larvae reared under laboratory conditions include phytoplankton algae (e.g. species of *Dunaliella*, *Chlorella*, *Micromonas*, *Tetraselmis*, *Hemiselmis*, *Ditylum*, *Prorocentrum*, *Isochrysis*, *Navicula*, *Nitzschia*, *Skeletonema*, *Phaeodactylum*), as well as small zooplankters such as larvae of polychaetes, barnacles, molluscs, echinoderms (also eggs) and brine shrimp—one of the best foods thus far tested. The importance of *Tetraselmis* sp. as a food source for larval crustaceans has been emphasized by GRIFFITH and co-authors (1973). Especially for more advanced developmental stages, also non-living foods have been used (e.g. commercial fish food; chopped boiled egg; chopped flesh of molluscs, crustaceans, fish; and beef). This list cannot conceal the fact that more detailed information on qualitative and quantitative aspects of nutrition as a function of developmental stage and environmental factors remains a basic prerequisite for future success. While some natantian larvae can complete part or all of their larval development on yolk reserves, most decapod larvae must take up external food. The nutritional requirements of adults are frequently less specific and less development-dependent, and hence easier to meet than those of the larvae.

Irregular body shapes and long spines and setae make decapod larvae often vulnerable to mechanical contact, and sticky detritus particles rapidly interfere with their locomotory and feeding mechanisms. Culture-container design and water movement patterns must pay tribute to such peculiarities. Sticky foods should be avoided. Moulting, especially in combination with malnutrition and territorial behaviour, may cause significant losses due to cannibalism unless hiding places or individual compartments are provided. While very low population densities may help, they are usually impractical (observation difficulties, space considerations, low yield). The fragile, delicate larvae are handled by pipetting (wide-mouth pipettes and slow water exchange are essential) or by small nets. For culture-water sterilization, aureomycin, streptomycin, penicillin and chloramphenicol have been used at concentrations ranging from 50 to 100 I.U. ml⁻¹ (see also p. 999, Chapter 2, pp. 383–385, and Chapter 5.11). The biological effects of antibiotic treatment require further investigations.

Numerous malacostracans—especially their larvae—have a considerable potential as assay organisms and as food organisms for other cultured animals. Only in very few cases has this potential been made use of.

(11) Mollusca

The soft-bodied molluscs comprise seven classes (HYMAN, 1967): the Aplacophora or solenogasters, the Polyplacophora or chitons, the Monoplacophora with the single order Tryblidiodea, the Gastropoda or snails, the Bivalvia (Lamellibranchia or Pelecypoda), the Scaphopoda or tusk shells, and the Cephalopoda which include *Nautilus*, octopuses and squids. In this section, we restrict ourselves to the Gastropoda and Bivalvia. Commercial cultivation of molluscs is dealt with in Chapter 5.2.

(a) Gastropoda

With over 36,000 species the largest mollusc class, the Gastropoda have received less attention from culturists than the Bivalvia (p. 900). Gastropods inhabit a great variety of biotopes and exhibit a high degree of variability in functions and structures. Only a few generalizations can be made in regard to characteristics that pertain to cultivation: (i) Within the class Gastropoda, environmental and nutritional requirements vary more than in most other invertebrate groups considered in this chapter. (ii) Members of the class include herbivores, carnivores, omnivores, scavengers, suspension feeders, deposit feeders and parasites. (iii) In most species, the primary food source changes in the course of the life cycle. (iv) Most marine gastropods pass through the trochophore stage within the egg; the free-swimming larva is the veliger which received its name from its characteristic swimming organ, the velum. (v) Veliger larvae are suspension feeders employing a ciliary feeding mechanism; they use phytoplankters as main food source. (vi) Most adults employ a radula for feeding; in addition, some retain or modify larval ciliary filtration habits. (vii) Many gastropods are dioecious; some release their gametes into the surrounding water, others copulate and have internal fertilization.

Rearing of Larvae

The veliger larva swims and feeds with the aid of its ciliated velum (Figs 5-78, 5-80, 5-81). In the metamorphosing larva, the velum is gradually reduced, shell and visceral mass twist 180° relative to head and foot, and the setting individual begins to increasingly adopt the adult mode of locomotion and feeding. As in other marine invertebrate larvae, a crucial problem to be solved by the cultivator is the provision of the right quality, size and concentration of food items (p. 891). Once the right food is known, can be reliably reproduced in quality and applied in proper quantities, the rest is often more or less routine.

Fertilization, incubation and hatching

While eggs of primitive prosobranchs are fertilized externally after release into the ambient water, some gastropods display complex copulation behaviour (see below). The eggs may be laid singly or in masses arranged in gelatinous ribbons. Some species produce single eggs surrounded by albumen and a shell or by a capsule or case. The eggs may be planktonic or are attached to a substratum.

Copulation has been observed in cultured pteropods *Paedocione doliiformis* (Fig. 5-77). In 2 cases, the partners separated a few minutes after observations began; in the third case, they remained in copulatory position for 3 hrs (LALLI and CONOVER, 1973). The two partners pair ventrally forming an angle of 90° or less between the long axis of their bodies. Each individual then rotates a few degrees counter-clockwise around the long axis of its body. The food lobes are directed away from the mid-line thus permitting close approximation between genital pores. In copulatory position, the pteropods glide or swim randomly, usually propelled by their cilia, the wings retracted into a fold between head and body. Fertilization appears to be reciprocal and is probably simultaneous.

Copulation behaviour similar to that described for *Paedoclione doliiformis* has been reported for *Clione limacina* (BOAS, 1886; KNIPOWITSCH, 1891). However, functional details and the complex copulatory structures remain to be investigated in both species. According to KNIPOWITSCH, *C. limacina* releases its eggs 20 to 24 hrs after copulation.

Fertilized gastropod eggs are prepared for incubation in a manner similar to that described for bivalves (p. 904). Using filtered, sterilized and temperature-adjusted sea water of appropriate salinity, the eggs are carefully washed. They are either placed on a grid of suitable pore size and rinsed, or repeatedly suspended, following setting in a beaker and subsequent decantation. Such washing is necessary in order to remove excess sperm, mucus and other contaminants.

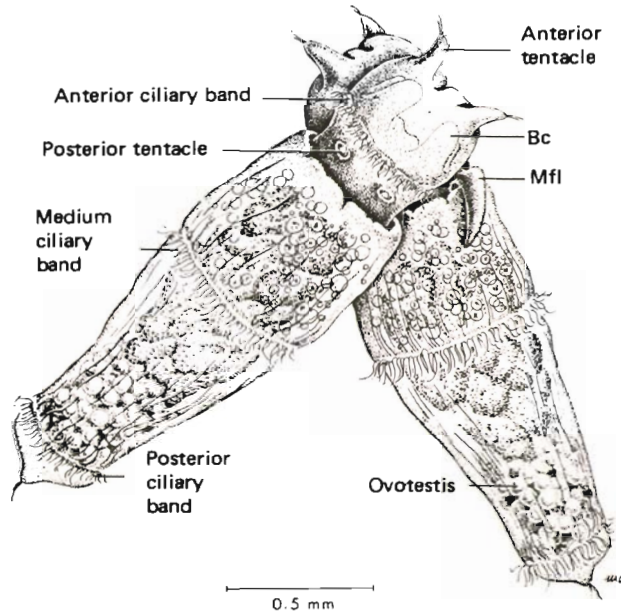

Fig. 5-77: *Paedoclione doliiformis*. Wings retracted, two individuals copulate; they may remain in this position for hours. Bc: buccal cone, retracted; Mfl: median foot lobe. (After LALLI and CONOVER, 1973; modified; reproduced by permission of Springer-Verlag.)

Washed, fertilized gastropod eggs have been incubated and hatched in shallow dishes, beakers or small aquaria, usually under conditions of mild aeration and dim illumination. The sea water used was mostly filtered and sterilized. In commercial mariculture farms in Japan, fertilized eggs of abalones are transferred to large hatching tanks ($2 \times 1.5 \times 1.2$ m deep), accommodating about 60,000 to 120,000 eggs in each tank (BARDACH and co-authors, 1972; see also Chapter 5.2).

Environmental and nutritional requirements

Our present knowledge on environmental and nutritional requirements of gastropod larvae is very limited. Only for a few species is some more detailed information available.

General culture procedures that proved successful for the larvae of several gastropod species have been outlined by PILKINGTON and FRETTER (1970) who concentrated their efforts on *Crepidula fornicata* and *Nassarius reticulatus*. *C. fornicata* larvae, hatched from egg capsules collected from the field, were placed in glass-filtered (pore size $3\ \mu\text{m}$) sea water (12°C) contained in acid-cleaned glass containers and provided with unicellular algal food (see below); culture vessels of

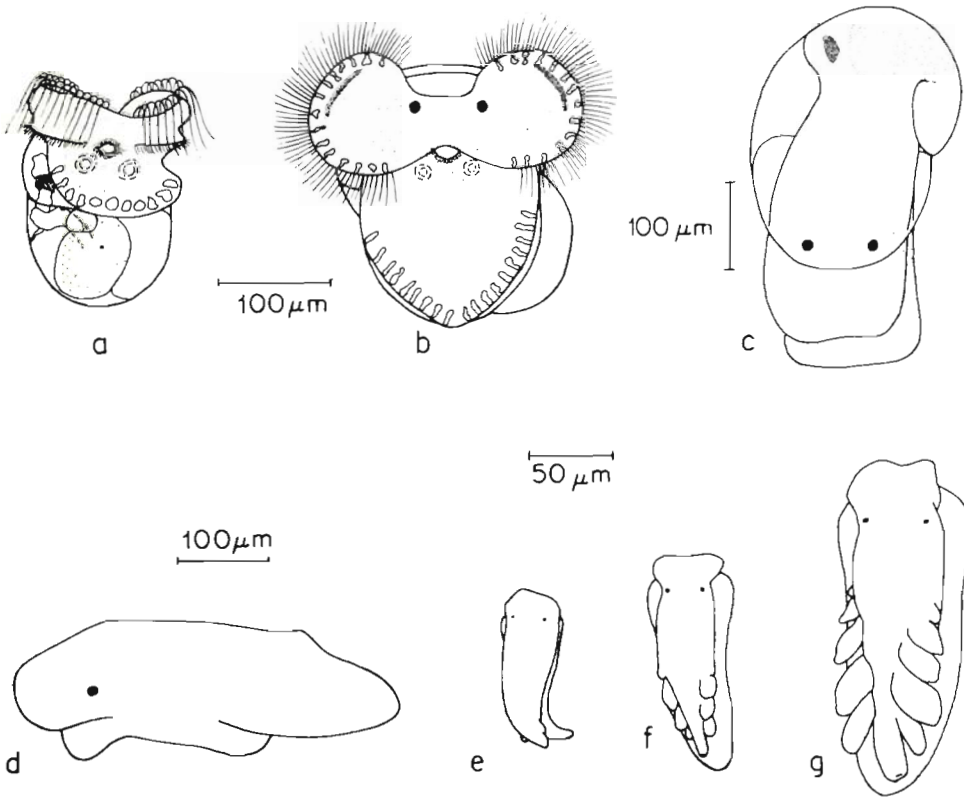

Fig. 5-78: *Alderia modesta* cultivated at 20°C , in diluted sea water. a and b: veligers, 5 days and 14 days old, respectively; c: larva ready to shed its shell; d: shell-less individual; e, f and g: early benthic stages developing an increasing number of cerata. (After SEELEMANN, 1967; modified; reproduced by permission of Biologische Anstalt Helgoland.)

polythene proved harmful to the larvae. The veligers were handled carefully by means of a pipette; trapping on coarse filters turned out to be injurious.

Veligers of *Alderia modesta* (and the very closely related saccoglossan opisthobranch *Limapontia depressa*) have been reared by SEELEMANN (1967). Except for a black anal gland, *L. depressa* larvae are practically identical to those of *A. modesta*. Veligers hatched from field-collected egg strings at a length of 90 to $110\ \mu\text{m}$. Surprisingly, the veligers (Fig. 5-78) hatch regardless of the (tidal) water level. In SEELEMANN's cultures, many newly liberated larvae did not reach the water and died. If fed sufficient amounts of *Dunaliella* sp., the veligers grow well. At 20°C ,

metamorphosis begins after about 3 weeks. The originally rather transparent veliger is now fairly dark and pigmented similar to the adult. Within 12 hrs, the velum becomes completely reduced, and the larva begins to crawl about on the setting substratum. It takes another 12 hrs for the digestive gland to be completely withdrawn from the whorl of the shell. Without any recognizable interruption in its movements, the larva suddenly sheds its shell together with the operculum (Fig. 5-78, c). The young slug (Fig. 5-78, d) immediately feeds on *Vaucheria* sp. If a veliger does not come into contact with *Vaucheria* sp., its metamorphosis is delayed for some time, but ultimately such larvae also metamorphose, regardless of the substratum. Two days later, the first pair of cerates grow next to the anus, and

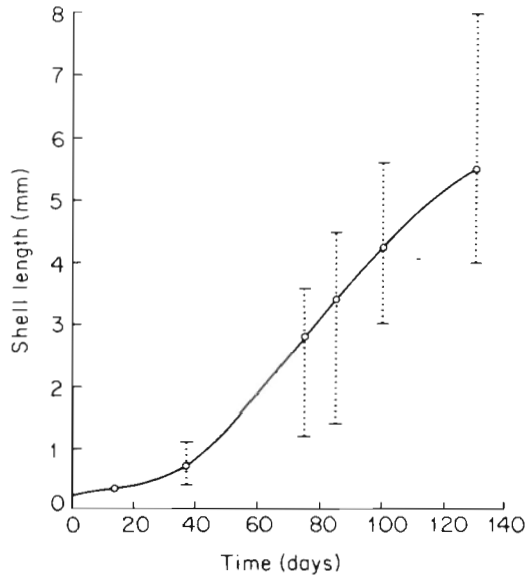

Fig. 5-79: *Haliotis sorenseni*. Growth rates (shell length) of larvae and juveniles cultivated in 1-l beakers. 15° to 17° C; mixed diatom diet. (After LEIGHTON, 1972; modified; not copyrighted.)

additional cerates are added as the young adult grows (Fig. 5-78, e-g). After 10 days, a length of 3 mm is attained and egg production begins (p. 896).

Larvae of *Anadara broughtonii* have been reared in a tank with sea water (21° to 26.8° C; 1.0184–1.0220 density; pH 7.8–7.9; moderate aeration; daily replacement of 1/3 or 1/4 of the water) by KIM and KOO (1973; see also KAN-NO and KIKUCHI, 1962). Mean egg diameter was 60 μ m, and it took about 20 to 21 hrs for the veliger (shell length: 80–88 μ m; shell height: 64–72 μ m) to develop. The umbo stage was attained after 2 weeks. Setting began at shell lengths between 200 and 270 μ m.

Of the ca 100 abalone species known, several have been maintained under laboratory conditions. However, larval growth and development were studied only in a few cases. Hatched from fertilized eggs (incubated at 12° C) after 24 to 36 hrs, larvae of the abalone *Haliotis sorenseni* were raised by LEIGHTON (1972). The

larvae soon aggregated at the water surface, from where they could be easily collected (pipette). For experiments on larval responses to temperature, LEIGHTON transferred groups of 20 72-hr-old veliger larvae into each of a series of 100-ml Pyrex beakers, illuminated from beneath to facilitate growth of the food algae. Each beaker contained 80 ml of Millipore-filtered, ultra-violet-treated sea water and 1 ml of a *Nitzschia* sp. suspension (ca 10,000 cells). The culture water was changed once a week and, at the same time, new food was supplied. Later, about 500 larvae were distributed among five 1-l Pyrex beakers. Growth rates reveal inherent variability; an example is presented in Fig. 5-79. At 15° C, settlement occurred after 9 to 10 days. Larval development under laboratory conditions has also received attention in *Haliotis discus hannai* (KAN-NO and KIKUCHI, 1962), *H. gigantea* (MURAYAMA, 1935), *H. diversicolor supertexta* (ŌBA, 1964; ŌBA and co-authors, 1968) and *H. rufescens* (CARLISLE, 1962).

In Japanese abalone farms, survival from larvae to juveniles suitable for stocking was only 1%. The major reason for this low survival is believed to be malnutrition immediately after setting (BARDACH and co-authors, 1972). *Littorina picta* larvae have been reared at 25° C in 36 to 37‰ S by STRUHSAKER and COSTLOW (1968; see also STRUHSAKER, 1966). When fed on *Phaeodactylum tricornerutum*, the development from hatching to setting required 3 to 4 weeks. Changeover from swimming to crawling occurred within about 4 days.

The growth and development of larvae of *Nassarius* species has received attention from SCHELTEMA and associates. The rearing methods employed (SCHELTEMA, 1962) are largely modifications of those developed by LOOSANOFF (1954) and are applicable to many other marine molluscs. Egg cases were collected in tidal flats or obtained from snails cultured in 4-l jars, covered with nylon netting and receiving a continuous flow of new sea water. In the latter case, most egg masses were deposited by the snails on the netting. At 20° to 25° C, the larvae hatch in 5 to 7 days. They were collected on a fine mesh screen, and placed into glass buckets of 15-l capacity containing aerated sea water. SCHELTEMA changed the culture water every second or third day by siphoning the entire contents of a bucket through a 140- μ m stainless-steel screen or through bolting cloth retained in a plastic cylinder. The veliger larvae received *Phaeodactylum tricornerutum* or *Nitzschia closterium* as food. Each time the culture water was changed, these phytoplankters were added to the new water at a concentration of 200,000 algal cells ml⁻¹. The development of *Nassarius obsoletus* is illustrated in Fig. 5-80.

Responses of *Nassarius reticulatus* veligers to light (PILKINGTON and FRETTER, 1970) indicate better growth in constant illumination ('Madza daylight', 155 lux) than under a 12-hr photoperiod or in darkness. In darkness, food-algal mortality stimulated bacterial growth and required daily water change. When growth of 20 veligers in 30 ml sea water (depth 8 cm) was compared with that of 333 veligers in 500 ml (depth 9 cm), growth in the larger water volumes tended to be better. Responses of *N. obsoletus* veligers to salinity and temperature have been investigated by SCHELTEMA (1965, 1967). Maximum growth rates were obtained near 25° C; the lowest temperature at which metamorphosis could be completed was 16° to 17° C. Lower salinity limits range for larvae from 14 to 15.5‰ S, for adults from 12.5 to 13.5‰ S; best growth is obtained in 33‰ S. Information relevant to cultivation has been presented also on *Nassarius incrassatus* (LEBOUR, 1931),

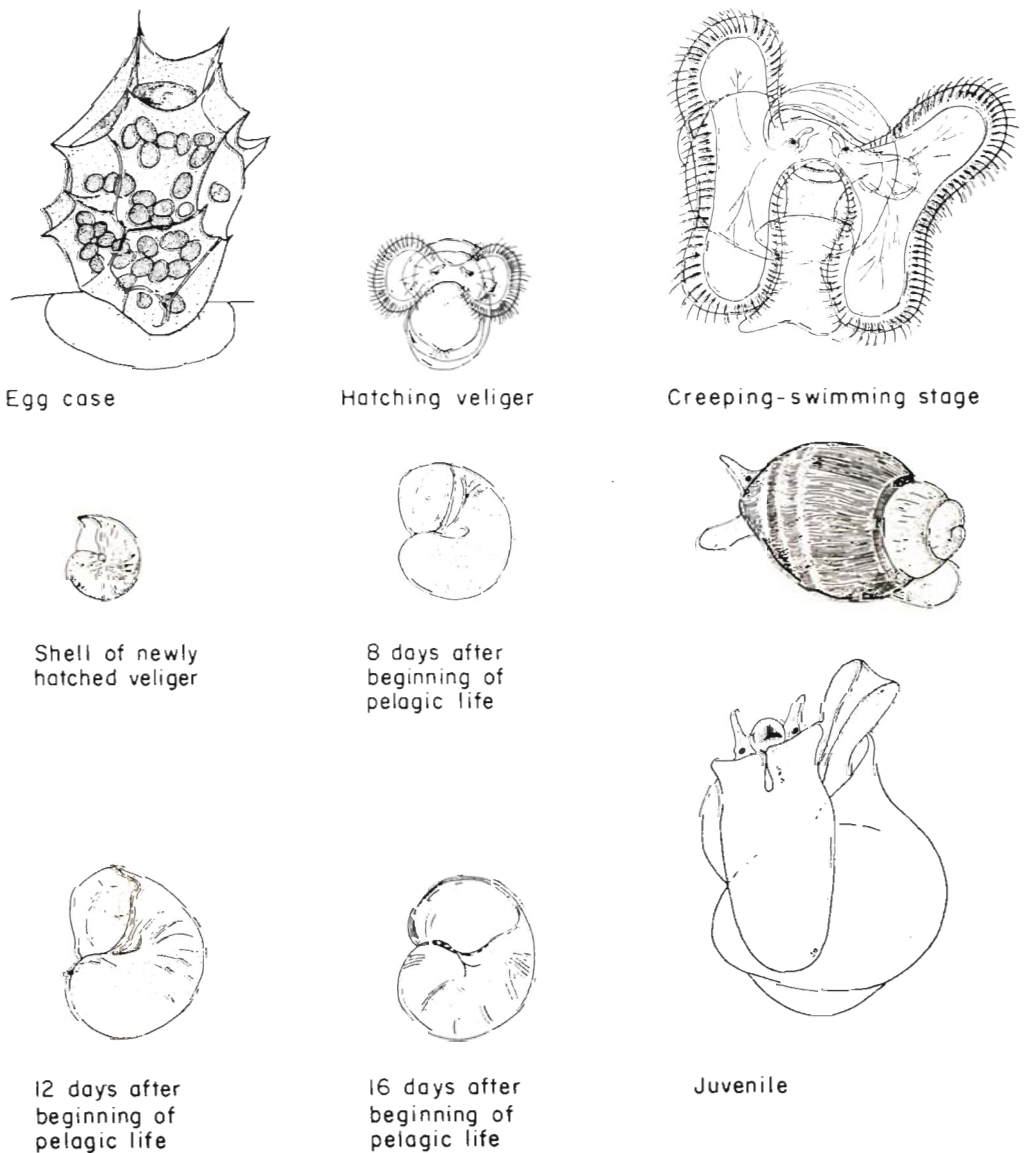

Fig. 5-80: *Nassarius obsoletus*. Larval development. (After SCHELTEMA, 1962; modified; reproduced by permission of American Microscopical Society.)

N. vibex (SCHELTEMA, 1962) and *N. trivittatus* (SCHELTEMA and SCHELTEMA, 1963, 1965).

From eggs laid by cultured adult pteropods *Paedoclione doliiformis* (p. 900), LALLI and CONOVER (1973) obtained, at 17° to 19° C, veligers within 3 days. About 11 days later, the veligers cast their shells (Fig. 5-81). Shell-less veligers attained the polytrochous larval stage within 12 hrs. These larvae begin to feed (on *Spiratella retroversa*) within 48 hrs after disappearance of their velum. As soon as carnivorous

feeding commences, growth rate increases. Sexually mature specimens can be distinguished by their larger size and the presence of internal reproductive structures.

Larvae of other gastropod species reared under laboratory conditions include those of *Anachis avara* (SCHELTEMA and SCHELTEMA, 1963) and *A. translirata* (SCHELTEMA, 1969).

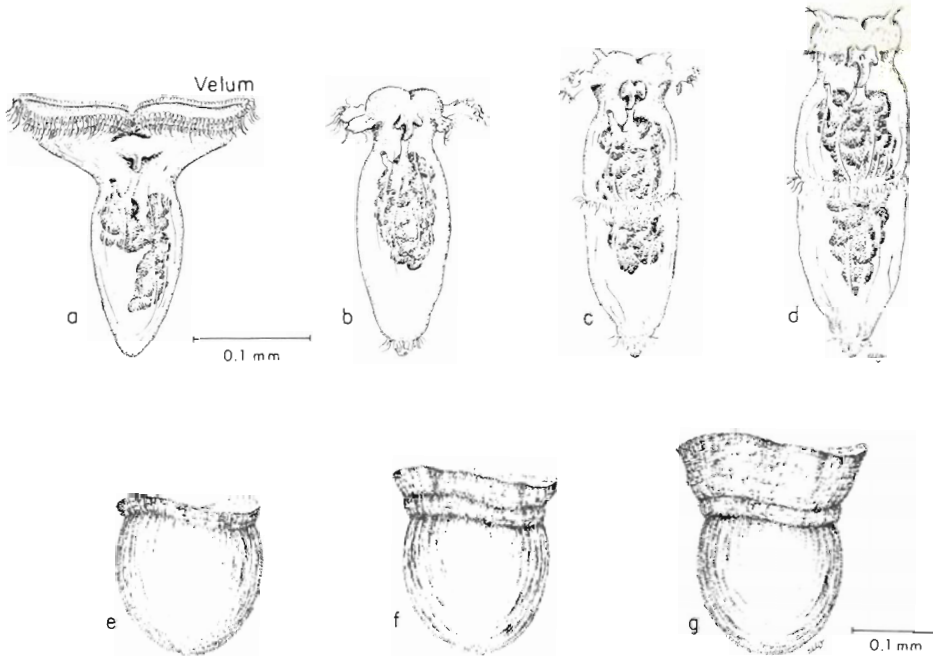

Fig. 5-81 : *Paedoclione dotiiformis*. a : Shell-less veliger; b : larva with 1 ciliary band and rudimentary velum; c : larva with 2 ciliary bands; d : polytrochous larva with 3 ciliary bands and completely developed head structures; e to g : shells of veligers (e, newly hatched; f, intermediate; g, at time of casting). (After LALLI and CONOVER, 1973; modified; reproduced by permission of Springer-Verlag.)

Gastropod veligers feed on small plankters and, possibly, on organic detritus. With the aid of their ciliated velum, they usually collect small particles suspended in the water column, but in cultures they have also been seen to sweep up sedimented particles with their velum. The food particles are directed via the food groove to the mouth.

Off Plymouth (England), PILKINGTON and FRETTER (1970) observed gastropod veligers feeding in the surface waters and well below compensation depth. When feeding stops, the velum may be partly withdrawn and the veliger sinks. The food particles collected by the velum are manipulated by cilia and muscles. Cilia pass

them along the oesophagus to the stomach chamber where they are rotated vigorously against the gastric shield, mixed with digestive juices and subjected to mechanical breakdown (FRETTER, 1967). Unwanted remains are directed into the style sac. From the style sac, the faecal mass is sucked into the initial part of the intestine, and finally compacted into rods and forced out of the anus by muscles. A hungry prosobranch gastropod veliger will fill its stomach in a few minutes if offered high concentrations of a good food. Then it will stop feeding and digest. Inorganic particles are passed directly to the intestine for defecation. If food is scarce, feeding is continuous.

Larvae of *Anadara broughtonii* fed and thrived on mixed phytoplankton diets composed of *Chaetoceros calcitrans*, *Monochrysis lutheri*, *Monas* sp. and *Skeletonema costatum*. Each larva received the following mean concentrations of food algae per day: 7000 cells at the D-shaped veliger stage, 12,000 cells at umbo stage, and 23,000 cells at post-umbo stage (KIM and KOO, 1973).

Veligers of *Crepidula fornicata* and *Nassarius reticulatus* were offered the food algae listed in Table 5-73. PILKINGTON and FRETTER (1970) made these algae available at 3 concentrations (2×10^3 , 20×10^3 , 40×10^3 cells ml⁻¹). *Cricosphaera* ap. *carterae* and *Exuviaella baltica* turned out to be the best foods for *Crepidula fornicata* veligers; at 12° C, the larvae were ready to metamorphose in 40 days or less. *C.* ap. *carterae* and *Dunaliella primolecta* provided good support for *N. reticulatus*. *E. baltica* yielded consistently poorer results (Fig. 5-82). None of the larvae metamorphosed on *Monochrysis lutheri* and *Pyramimonas grossii*. *Chlamydomonas parkeae* and *Brachiomonas submarina* are poor foods; *E. pusilla* and *Olisthodiscus* sp. are toxic.

Table 5-73

Algae fed to veliger larvae of *Crepidula fornicata* and *Nassarius reticulatus*. Abbreviations are used in Fig. 5-82 (After PILKINGTON and FRETTER, 1970; modified; reproduced by permission of Biologische Anstalt Helgoland)

Species	Size	Abbreviation
<i>Brachiomonas submarina</i> var. <i>pulsifera</i>	(8 × 20 μm)	Bs
<i>Chlamydomonas parkeae</i>	(3–8 μm)	Cp
<i>Cricosphaera</i> ap. <i>carterae</i>	(10–18 μm)	Cc
<i>Dunaliella primolecta</i>	(5–10 μm)	Dp
<i>Exuviaella baltica</i>	(9–15 μm)	Eb
<i>Exuviaella pusilla</i>	(8–10 μm)	Ep
<i>Monochrysis lutheri</i>	(6–10 × 2–3 μm)	Ml
<i>Olisthodiscus</i> sp.	(10–15 μm)	Os
<i>Phaeodactylum tricornutum</i>	(8–35 μm)	Pt
<i>Pyramimonas grossii</i>	(5.5–8 × 4.5–5.5 μm)	Pg

Larvae of the abalone *Haliotis sorenseni* received mixed algal diets: about 10 different diatoms, chiefly species of *Nitzschia*, *Grammatophora*, *Navicula* (LEIGHTON, 1972). Veligers of the pteropod *Paedocione doliiformis* have been cultured on a

mixture of *Isochrysis* sp. and a diatom resembling *Nitzschia*. At 17° to 19° C, most veligers fed readily and grew considerably; polytrochous *P. doliformis* larvae changed, within 2 days after the velum had disappeared, to carnivorous foods; they fed on freshly caught pteropods *Spiratella retroversa* (LALLI and CONOVER, 1973).

The algal cells ingested by the veliger are subjected to mechanical treatment in the stomach. While their cell walls may be shattered, no fragments have ever been

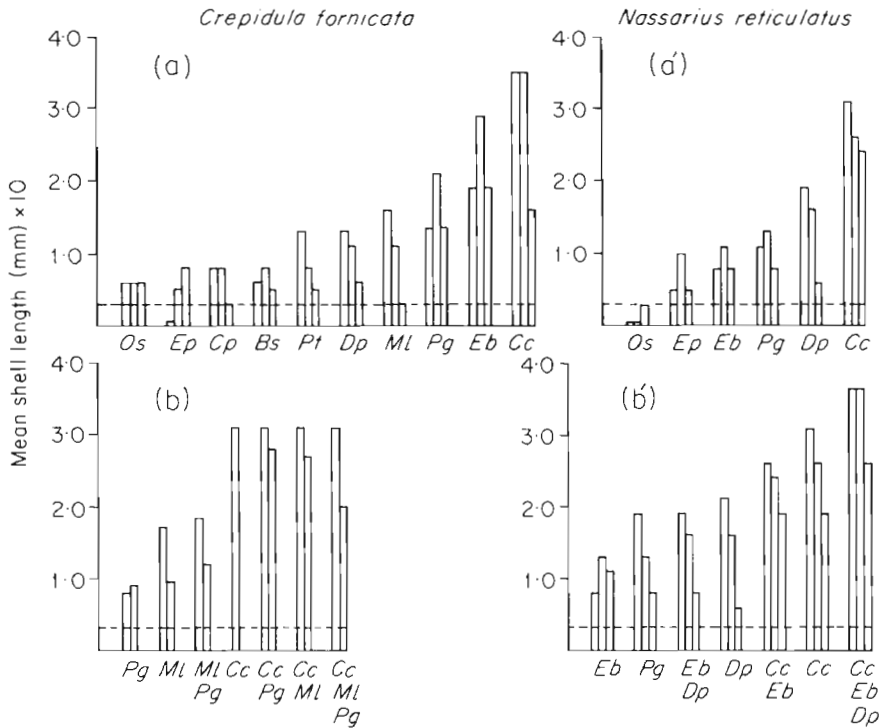

Fig. 5-82: *Crepidula fornicata* and *Nassarius reticulatus*. Mean shell lengths of veliger larvae attained on different diets. For abbreviations see Table 5-73. The 3 columns above each alga indicate growth rates at 40×10^3 (left), 20×10^3 (middle) and 2×10^3 (right) cells ml⁻¹; where there are only 2 columns, the lowest food concentration was not used and where there is only 1 column, the highest concentration was used. (a) and (a¹): single-alga diets; (b) and (b¹): single and mixed diets. Broken line: mean shell length of unfed larvae. 12° C. (After PILKINGTON and FRETTER, 1970; modified; reproduced by permission of Biologische Anstalt Helgoland.)

seen in the cells of the digestive gland. Algae with complete cellulose walls resist digestion; this fact suggests the absence of cellulase. Plant pigments are egested by the veliger, and some algae (species of *Monochrysis*, *Phaeodactylum*, *Pyramimonas*) cause the production of high proportions of faecal waste material which, in less vigorous larvae, may clog the exhalent passage of the mantle cavity. PILKINGTON and FRETTER (1970) assume that differences in food value of the various algae tested may be due to differences in essential micronutrients and vitamins, and that organic detritus in the sea represents an important food item for the larvae.

Littorina picta larvae thrived on *Phaeodactylum tricornerutum* offered at concentrations of 2×10^5 cells larva⁻¹ (STRUHSAKER and COSTLOW, 1968).

Nassarius obsoletus veligers exhibit selective feeding (PAULSON and SCHELTEMA, 1968). When offered a mixture of *Cyclotella nana*, *Dunaliella tertiolecta* and *Phaeodactylum tricornerutum*, early larvae preferred *C. nana* to the other two algae, and for veligers of all sizes, *D. tertiolecta* was the last choice. With increasing size and age, the differences between the numbers of *C. nana* and *P. tricornerutum* selected diminish, while increasing numbers of *P. tricornerutum* are collected in preference to *D. tertiolecta* (Table 5-74).

'Artificial' foods (cornflour, Liquifry—a food for newborn fish consisting mainly of pulverized diatoms—and drinking chocolate) have been tested as potential diets for cultivated veligers of *Crepidula fornicata* and *Nassarius reticulatus* by MAPSTONE

Table 5-74

Nassarius obsoletus. Selective feeding: average percentages of food-alga cells removed from suspension when given a choice of the 3 algae indicated. In parentheses: standard error of the mean (After PAULSON and SCHELTEMA, 1968; modified; reproduced by permission of Biological Bulletin)

Larvae	<i>Cyclotella nana</i>	<i>Phaeodactylum tricornerutum</i>	<i>Dunaliella tertiolecta</i>
Newly emerged veliger larvae (6 experiments)	72.9 (±6.6)	39.2 (±8.1)	33.1 (±8.4)
Veliger larvae of 200–400 μm length (7 experiments)	83.9 (±3.8)	69.1 (±8.8)	50.1 (±11.5)
Veliger larvae of 400–600 μm length (3 experiments)	70.2 (±11.9)	71.9 (±4.0)	24.5 (±3.6)

(1970). Prior to each experiment, newly hatched larvae were transferred to glass-filtered sea water and kept at 14° C for 2 days without food in order to deplete the yolk store. Excessive bacterial growth was controlled by antibiotics (prepared according to WALNE, 1958, 1974; see p. 916). Fresh antibiotic solutions were made up and added to the culture each time the water and food were renewed. Offered in concentrations of 2×10^3 or 20×10^3 particles ml⁻¹, the artificial foods settled to form a bottom layer. Although some growth of *N. reticulatus* veligers occurred on artificial foods, it was less than with *Cricosphaera* sp. *carterae*, and growth ceased after 8 to 10 days. Over the first 7 days, growth was best with cornflour, less good with Liquifry and poor with drinking chocolate—owing, at least in part, to bacterial contamination. Since growth was resumed when larvae fed on Liquifry were offered *C. ap. carterae*, they apparently remained healthy. At best, the artificial foods tested can be used over short periods of time; presumably, they lack essential nutritional components present in natural foods.

The treatment of food by prosobranch veligers has received attention from FRETTER and MONTGOMERY (1968).

Metamorphosis and setting

Metamorphosis and setting of gastropod larvae are less well investigated than in bivalve larvae (p. 917). However, the limited information at hand suggests that a basically similar situation prevails. SCHELTEMA (1961) found substrates inhabited by micro-organisms to be significantly more attractive to setting *Nassarius obsoletus* larvae than substrates rendered 'abiotic' by heat treatment (incineration). The metamorphosis-inducing or -promoting properties of a substratum can be transferred to the adjacent water; this suggests that dissolved organic substances are involved and that physical contact between larva and substratum is not necessary for stimulus perception. The presence of a favourable substratum exerts a marked, positive effect on metamorphosis (higher percentage of metamorphosed individuals). In the absence of a suitable substratum, the larvae postpone metamorphosis for over 2 weeks. Since adult *N. obsoletus* are primarily deposit feeders, the selection of a suitable substratum is essential for successful establishment.

For setting abalones, Japanese culturists offer 50-cm square corrugated plastic sheets as substratum (BARDACH and co-authors, 1972). They immerse the sheets prior to use as larval 'collectors' in running sea water to allow a film of micro-organisms and diatoms to develop. Abalones which are about to commence feeding on benthic diatoms readily accept such collectors. Up to 10,000 young abalones settled on each plastic sheet. After attachment, the sheets are transferred in lots of 1000 to outdoor tanks (10 × 10 × 2 m deep), supplied with running sea water.

When palagonite tuff, reef limestone, basalt and quartz (ca 5 cm³) were offered as setting substrata to *Littorina picta* larvae, they did not appear to prefer any particular substratum. They also settled on all types of rock or on glass surfaces, provided these were covered with a thin film of 'algae or detritus'. However, when such films were removed from portions of the setting substratum, no larvae settled in these areas (see also p. 919). After settlement, post-veligers crawled over the substratum more actively during the night than during the day. Water movement caused increased locomotory activity.

For setting larvae of *Anadara broughtonii*, KIM and KOO (1973) provided minnow net and Spanish moss. However, the larvae died due to tannin leakage from the moss. Hence, the authors propose collectors of manila fibre, palm skin or non-toxic synthetic fibre as setting substrata.

Rearing of Juveniles and Adults

Juvenile and adult gastropods often exhibit environmental and nutritive requirements which are different from those of the larvae. Especially in forms with planktonic larvae and benthonic adults, the differences may be significant. Larval abalones, for example, collect phytoplankton, but newly settled individuals graze on benthic diatoms and, at a length of 2.5 mm, begin to feed on soft, multicellular, benthic algae such as *Ulva lactuca* and species of *Laminaria* or *Undaria*.

Several of the culture systems used for rearing juvenile and adult gastropods have been presented in Chapter 2. MOORE (1960) described a filtration-aeration unit for experimental gastropod aquaria, and POIZAT (1972) developed a closed sea-water system for cultivating opisthobranchs. A technique for axenizing cultured prosobranchs has been outlined by MICHELSON (1959).

In cultured adult Japanese abalones, satisfactory growth has been obtained on an 'artificial' diet (Table 5-75). Some forms exhibit diurnal rhythms in food uptake. In adult abalones, the best feeding time is considered to be 2 to 3 hrs after sunset or before sunrise.

The opisthobranch *Alderia modesta* which inhabits supralittoral fringe areas with abundant algal growth (*Vaucheria* sp.) has been cultivated by SEELEMANN (1967) in glass dishes containing a layer of cotton wool, moistened with diluted sea water. A thin slice of natural substratum with *Vaucheria* sp. was added as food source. The snail embraces an algal filament with its propodium, bites a hole into it and sucks out the cell sap. At 20° C, *A. modesta* produced egg strings throughout the year. One individual may produce about 1000 eggs day⁻¹. One copulation is sufficient for fertilizing several egg strings which are attached with a hyaline substance to the surface of the *Vaucheria* substrate, preferably on the steep slope of small depressions. In spite of the fact that appreciable salinity fluctuations can be ex-

Table 5-75

'Artificial' diet for juvenile *Haliotis discus* (After BARDACH and co-authors, 1972; reproduced by permission of Wiley, New York)

Components	Amount (%)
Sodium alginate	45
White-fish meal	40
Crude protein	27
Dried <i>Undaria</i> sp.	10
Starch	5

pected to occur in most habitats occupied by *A. modesta*, SEELEMANN comes to the conclusion that adults, larvae and eggs are sensitive to changes in salinity; while the species is euryhaline, the individuals are considered stenohaline. Fully grown adults measured about 5 mm (North Sea) or 8 mm (Baltic Sea).

For parasitological research, *Batillaria minima* has been cultivated in a large, aerated sea-water aquarium (WAGNER, 1960). For feeding, the snails were transferred twice a week to 10-cm finger bowls containing food and aerated sea water—a method also employed for several other marine snails. The food for *B. minima* consisted of frozen shrimp, fresh and baker's yeast, scrapings of blackboard chalk and 'Vita-Mins' bricks (KAGAN and co-authors, 1954). These dietary components were offered simultaneously and in excess to the amounts which could be eaten during a 4- to 8-hr period. The snails were then returned to the large aquarium after food adhering to their shells had been removed. All foods offered were ingested. After about 1 month, *B. minima* started to migrate out of the water on the sides of the aquarium. This behaviour could be curtailed by removing the snails once a week and allowing them to remain at room temperature for a period of 12 hrs. *Littorina pintade* and related gastropods used for parasitological studies have been maintained under laboratory conditions by painting a thin film of snail food in

the inside bottom of a 4-l jar (CHU and RYAN, 1960). After thorough air drying, 20 or more snails were placed in the container and the entire inside of the jar was moistened with 300 ml of sea water. With an inverted finger bowl as a cover, the whole arrangement was carefully turned over and more sea water added to the bowl to equalize the water level in both containers.

Adult *Clione limacina* have been fed *Spiratella helicina* and *S. retroversa* (LALLI, 1970; CONOVER and LALLI, 1972). *C. limacina* offered either prey, displayed no apparent preference; however, all size groups preferred the largest prey that could be handled mechanically. The prey is completely extracted from its shell within 2 to 45 mins. While early larvae of *C. limacina* feed only on veligers of the *Spiratella* species, 0.6-mm long polytrochs begin to consume subadult and adult *Spiratella* individuals. Prey recognition in *C. limacina* was elicited by the presence of live *S. helicina* or *S. retroversa* and reinforced by tactile recognition of the prey's shell, but prey removed from its shell by the experimenter was also eaten.

Members of *Crepidula* species (*C. adunca*, *C. plana*, *C. fornicata*, the benthic *C. williamsi*) filter ambient water through sheets of mucus (principle of endless filter band) and transport the food particles retained via the food groove to the mouth (ORTON, 1912; YONGE, 1938; WERNER, 1951, 1953b, 1959). The materials ingested consist of bacteria and phytoplankters, such as dinoflagellates and diatoms, together with various kinds of flagellates, ciliates and other protozoans, ova and spermatozoa of invertebrates, and organic detritus derived from disintegrated cells. Young individuals also browse on substrate-attached food with the help of their radula (COE, 1947, 1948). According to WERNER (1953b), adult *C. fornicata* can produce a water current strong enough to counteract considerable sedimentation.

The planktonic *Paedoclione doliiformis*, a pteropod which retains external larval features throughout its life, has been maintained under laboratory conditions by LALLI and CONOVER (1973). Pteropods collected with plankton nets (233- μ m aperture) were kept in crystallizing dishes (35 \times 50 mm), each containing one individual. The food consisted of freshly caught *Spiratella retroversa* (see also LALLI, 1972).

Gamete maturation

Only a few marine gastropods have thus far reproduced under controlled environmental and nutritional conditions. While mariculturists have occasionally succeeded in maintaining a breeding stock and have thus begun to lay the foundations for selective breeding and stock improvement, the degree of control attained in bivalve gamete maturation and gamete release (p. 924) has not yet been attained in gastropods.

Controlled gamete maturation can be effected by exposure to specific thermal conditions. The procedure is similar to that employed for bivalves (p. 925). Adult *Haliotis discus hannai*, for example, may be kept at low temperatures to suppress spawning until desired (KIKUCHI and UKI, 1974a). As the temperature is slowly raised to about 20° C, the gonads mature readily. Mature gonads are green in females and milky white in males. Usually, the most active individuals are the best spawners (e.g. ŌBA, 1964). In *Nassarius obsoletus*, reproduction can also be induced or delayed to some extent by thermal conditioning (SCHELTEMA, 1962).

Crepidula species and some other gastropods pass through a functional male phase when young and, later, change to the female phase (GOULD, 1917). The duration of the male phase and the time of turnover depend on environmental and nutritive conditions. Only a suitable environment and the availability of adequate food allow a normal sequence of events (COE, 1948). Studies on *C. fornicata* under *in situ* conditions (CHIPPERFIELD, 1951) revealed that (i) spawning commences at temperatures above 10° C; (ii) females reproduce at least twice each season; (iii) larval life lasts about 35 days; (iv) young spat are highly mobile and emigrate from sheltered positions in order to settle on existing chains of individuals. They first take up a terminal position, and finally one on the right side of an adult female.

Gamete release

In the sea, gastropods, as many other invertebrates, begin to spawn when a certain temperature level is reached after a period of either slowly increasing or

Table 5-76

Stimulation of gamete release in gastropods (Compiled from the sources indicated)

Species	Stimulus	Author
<i>Haliotis discus</i>	Thermal	INO (1952), KAN-NO and KIKUCHI (1962), IMAI (1967), INOUE (1969), KIKUCHI (1964), LEIGHTON (1972)
	Chemical	INO (1952)
	Electrical	KAN-NO and KIKUCHI (1962)
	Osmotic (air exposure)	INOUE (1969)
	Radiant (ultra-violet exposure)	KIKUCHI and UKI (1974b)
<i>H. diversicolor</i>	Thermal	ŌBA (1964)
<i>H. gigantea</i>	Biological	MURAYAMA (1935)
<i>H. rufescens</i>	Osmotic (air exposure)	CARLISLE (1945)
<i>H. sieboldii</i>	Thermal, chemical	INO (1952)
<i>H. tuberculata</i>	Mechanical	MEDEM and GRAF (1948)
<i>Turbo cornutus</i>	Thermal, osmotic (air exposure)	AI (1965)

(more rarely) decreasing temperature—sometimes also in response to sudden temperature change (Volume I: KINNE, 1970, p. 487). As has been shown by several Japanese workers, the abalones *Haliotis discus hannai* usually spawn when the rising temperatures have reached 16° to 20° C. The more southern species *H. gigantea*, *H. sieboldii* and *H. diversicolor* require somewhat higher temperatures. Possibly, changes in photoperiod may also be involved.

Under laboratory conditions, the following stimuli have resulted in gamete release, providing the gastropod tested had ripe gonads: biological, thermal, osmotic, electrical, mechanical, chemical and radiant (Table 5-76). Much the same stimuli are effective in bivalves (p. 925) and echinoderms (p. 960).

Biological stimuli are produced by mature gametes of other gastropods, preferably conspecifics. Egg and/or sperm suspensions are obtained from mature individuals and added to the culture water.

Thermal stimuli have been used, for example, in mature *Haliotis discus hannai*. Individuals acclimated to 20° C were exposed to increased temperatures (23° to

27° C) for 30 to 60 mins (INO, 1952). In some cases, repeated thermal shocks may be necessary. According to LEIGHTON (1972), no more than 5% of the eggs liberated after thermal shock treatment were successfully fertilized.

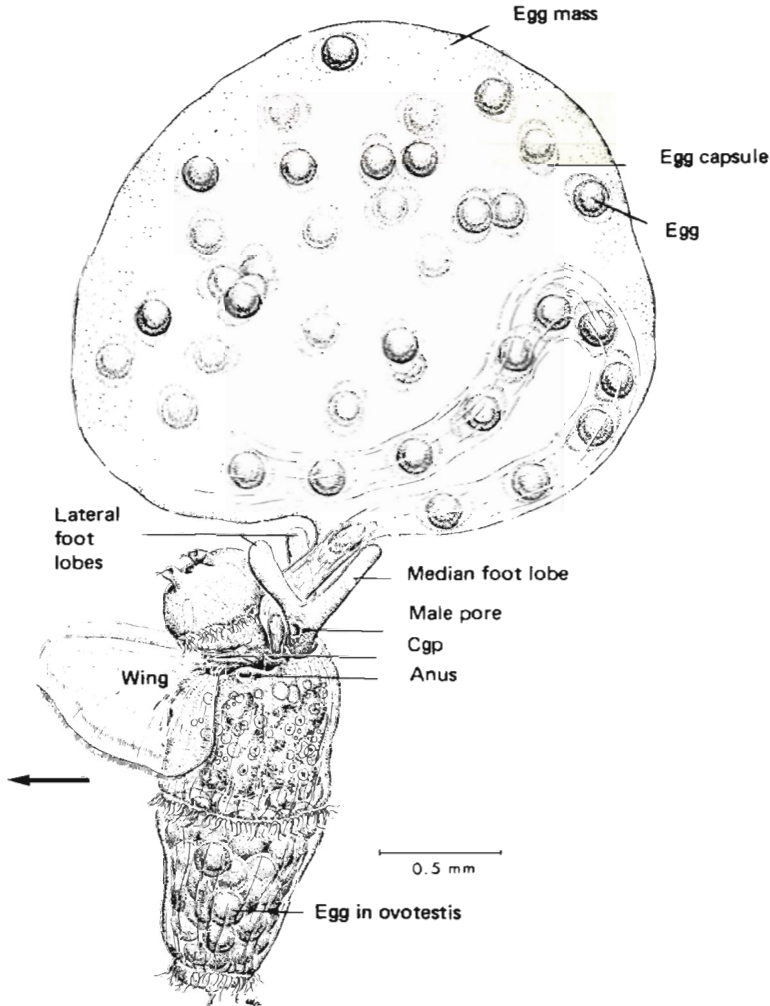

Fig. 5-83: *Paedocione doliiformis*. Spawning individual. Arrow indicates direction of movement produced by wings. Cgp: common genital pore. (After LALLI and CONOVER, 1973; modified; reproduced by permission of Springer-Verlag.)

Osmotic stimuli appear to be involved in cases in which gastropods have spawned following temporary air exposure, e.g. *Haliothis discus* (INOUE, 1969) and in *Turbo cornutus* (AI, 1965). *H. discus* also responded to electrical (KAN-NO and KIKUCHI, 1962) and chemical (INO, 1952) stimuli. Mechanical stimulation (rough handling or

manipulation of the shell) caused spawning in *H. tuberculata* (MEDEM and GRAF, 1948).

Ultra-violet irradiation yields, apparently, better results than thermal shocks. According to KIKUCHI and UKI (1974b), mature *Haliotis discus hannai* release their gametes promptly after treatment with ultra-violet light (800 mW hrs l⁻¹). Females responded after 2 hrs 42 mins, males after 3 hrs 18 mins. The radiant energy applied is considered harmless to the abalone. KIKUCHI and UKI assume that photochemical reactions produce substances which induce gamete release. Ultra-violet irradiation has also been shown to induce gamete release in ripe *H. gigantea* and in *Chlamys farreri nipponensis*.

Other stimuli involve sudden changes in salinity or pH. Possibly, in gastropods ready to spawn, different stresses (shocks) act through a similar or identical intervening physiological agent. Further research is required before detailed conclusions can be drawn in regard to the releasing agent.

Sexually mature *Paedoclione doliiformis*, sustained by LALLI and CONOVER (1973), released their eggs singly. Squeezed from the genital pore, egg capsules are first fusiform in shape, but then swell and, within 10 to 20 secs, become oval. The eggs are deposited in a spherical, free-floating mass (Fig. 5-83). After the last egg was laid, *P. doliiformis* continued to swim around the egg mass for as long as 20 mins, presumably adding mucus. According to LALLI and CONOVER, 10 to 20 mins elapsed from the release of the first egg to the time the ovipositing individual retracted its wings and sank away from the egg mass. For several days, each *P. doliiformis* may oviposit repeatedly. The egg masses released contained from 4 to 165 eggs. The number of eggs laid per individual depends upon temperature and nutrition. As in some benthic prosobranchs and opisthobranchs, the foot lobes play an important role in the moulding of the stream of extruding eggs into a spherical mass. As embryonic development proceeds, the originally transparent egg-mass matrix becomes increasingly opaque and, finally, begins to disintegrate, thus facilitating the veliger's liberation. *Chione limacina* produces ribbon-like, transparent, floating egg masses (LEBOUR, 1931) that contain more, but smaller, eggs than those of *P. doliiformis*.

(b) Bivalvia

The class Bivalvia, also known as Lamellibranchia or Pelecypoda, includes the oysters, clams and mussels. Most bivalves are laterally compressed suspension feeders, characterized by the possession of two valves with a dorsal hinge. Typically, marine bivalves have two free-swimming larval stages, the trochophore and the veliger (similar to gastropod veliger, but symmetrical). During metamorphosis, the veliger loses its velum and begins bottom life. Bivalvia trap and sort small suspended particles by their ciliary feeding mechanism (Volume II: PANDIAN, 1975, p. 80). While the food actually consumed under natural conditions is insufficiently known, bivalves have been raised on a variety of phytoplankters (p. 909). Histological studies indicate that the bivalve filtering mechanism may retain particles down to a size of a few μm . Examples of primarily deposit-feeding bivalves are *Scrobicularia plana* (HUGHES, 1969) and *Macoma nasuta* (HYLLEBERG and GALLUCCI, 1975). These forms probe the surrounding sediment surface with the tip of their siphon and suck in suitable material.

Commercial interests have directed most studies on bivalve cultivation toward profit-oriented enterprises concerned with edible members of the class. Since bivalves convert planktonic primary producers directly into high-quality meat and 'waste' little or no energy on locomotion, they are ideal objects for mass producing human food (Chapter 5.2); however, the concomitant production of large amounts of shell material must be considered a disadvantage, unless specific use can be made of such material.

Among the bivalves, oysters have received unique attention (Table 5-77). While the primary interest of most culturists was to enhance growth and reproduction of high-priced seafood oysters, much information of ecological importance has been produced. The flood of papers published prohibits exhaustive treatment. Since the basic problems of bivalve cultivation are similar in most of the species studied thus far, we shall outline here some principal aspects of bivalve cultivation, primarily on the basis of information obtained on the European flat oyster *Ostrea edulis*, the more euryhaline American oyster *Crassostrea virginica*, and the Japanese or Pacific oyster *C. gigas*.

In addition to water-quality management (Chapter 2), adequate nutrition of larval stages (p. 904) and disease control (KINNE (in press)) constitute the major problems in cultivating marine bivalves. Under laboratory conditions and in outdoor-tank experiments, bivalves have been raised on a variety of unicellular algae. In general, the larval stages are most sensitive to environmental conditions, and hence, require the most careful attention from the cultivator. Sensitivity tends to decrease in spat (p. 921), and more so in adults (p. 923).

Early pioneers in bivalve cultivation include RYDER (1883), MOORE (1898), WELLS (1920, 1926, 1927), PRYTHERCH (1924), HORI and KUSAKABE (1927), COLE (1937, 1939), HUGHES (1940), WILSON (1941), IMAI and co-authors (1950, 1954) and LOOSANOFF and co-authors (e.g. 1955). Important reviews on bivalve cultivation have been presented by HAGMEIER (1933), KÄNDLER (1933), NEEDHAM (1937), BAUGHMAN (1948), KORRINGA (1952), YONGE (1960), LOOSANOFF and DAVIS (1963a, b), GALTSOFF (1964), QUAYLE (1969), FUJIYA (1970), WALNE (1970a, 1974), LOOSANOFF (1971), MATTHIESSEN (1971), BARDACH and co-authors (1972), MASON (1972) and SADYKHOVA (1973). A bibliography of oysters (containing references on sponges, bivalves and gastropods) has been compiled by GALTSOFF (1972). Filtration dynamics in molluscs have been reviewed in Volume IV: CONOVER (in press).

Concentrating on *Crassostrea virginica* and *Mercenaria mercenaria*, LOOSANOFF and DAVIS (1963a, b) have devoted special subsections to *Anomia simplex*, *Arca transversa*, *Crassostrea gigas*, *Ensis directus*, *Laevicardium mortoni*, *Mactra* (= *Spisula*) *solidissima*, *Mercenaria* (= *Venus*) *campechiensis*, *Modiolus demissus*, *Mya arenaria*, *Mytilus edulis*, *Ostrea edulis*, *O. lurida*, *Pecten irradians*, *Petricola pholadiformis*, *Pitar* (= *Callocardia*) *morrhuaana*, *Tapes semidecussata* and *Teredo navalis*. WALNE paid most attention to *Ostrea edulis*, but also considered *Choromytilus chorus*, *Crassostrea gigas*, *Mercenaria mercenaria*, *Ostrea chilensis*, *O. lutaria* and *Venerupis decussata*. *Pecten maximus* has been cultivated by GRUFFYDD and BEAUMONT (1972). Papers on oyster genetics and its role in cultivation have been presented by LONGWELL (1968) and LONGWELL and STILES (1970, 1972, 1973a, b).

Table 5-77
 Oysters cultivated in commercial farms: some of their key characteristics (After BARDACH and co-authors, 1972; modified; reproduced by permission of Wiley, New York)

Species	Habitat	Spawning season	Spawning temperature (°C)	Incubation period	Duration of larval period	Countries where cultivated
<i>Crassostrea angulata</i> (Portuguese oyster)	Intertidal; in estuaries where current is strong	Summer	20 or more	Unknown	15-20 days	Portugal, Spain, Atlantic coast of France, Japan, Tunisia, USA
<i>C. commercialis</i> (Sydney rock oyster)	From intertidal to 3 m below low tide	Summer and fall	Peak at 21-23	6 hrs	14-21 days; Setting: February-April	Australia, from southern Queensland to eastern Victoria and New Zealand
<i>C. eradellae</i> (slipper oyster)	Intertidal	Spring and summer; peaks: during rainy season (July-August) Peaks: May-June in Japan Inland Sea, August-September in North Japan	30-33	Unknown	7 days	Philippines
<i>C. gigas</i> (Pacific oyster)	Intertidal		Begin at 19-20, peak at 23-25	5-6 hrs	10-14 days; Setting peak: in August	Japan, Korea, Taiwan, Pacific coast of USA and Canada, Australia, France, Netherlands, Portugal, Thailand, United Kingdom
<i>C. rhizophorae</i> (mangrove oyster)	Intertidal, 0.5-3.0 m	Peaks: May-September in Venezuela	Unknown	Unknown	Continuous setting; Peaks: July-August in Venezuela; February-April in Cuba	Experimentally in Cuba and Venezuela
<i>C. virginica</i> (American oyster)	Intertidal to more than 30 m (spawning and spat setting most successful in estuaries)	Long Island Sound: mid-July-early October; Chesapeake Bay: mid-June-mid-October; South Carolina: May-October; Gulf of Mexico: April-November	Begin at 20	Unknown	10-21 days	USA, Canada, Japan
<i>Ostrea edulis</i> (flat oyster)	In estuaries where current is weak	June-September in Morbihan area of France	20 or more	8 days	12-14 days	Atlantic coast of France, Spain, Netherlands, Great Britain, Japan, USA

Rearing of Larvae

Fertilization, incubation and hatching

Eggs should be fertilized (inseminated) as soon as possible after their release. When a sperm suspension is used to stimulate spawning (p. 925), fertilization occurs automatically, since spermatozoa are present when the females begin to discharge their eggs. In other cases, fresh, actively moving spermatozoa are added to a dish containing washed, freshly released eggs. LOOSANOFF and DAVIS (1963a) always used 'sufficient quantities' of sperm. Large amounts of decomposing sperm may cause fouling and hinder egg development. Apparently, the process of fertilization is rather independent of age. According to LOOSANOFF and co-authors (1953b), 40-

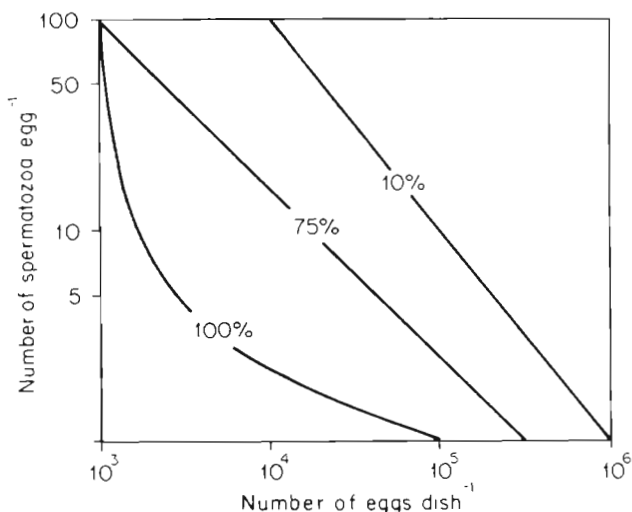

Fig. 5-84: *Pecten maximus*. Percentage of normal larvae obtained from different concentrations of ova and spermatozoa. 14° C. (After GRUFFYDD and BEAUMONT, 1970; reproduced by permission of Biologische Anstalt Helgoland.)

year-old oysters can produce eggs which are as viable as those obtained from 2-year-old conspecifics.

The concentrations of eggs and spermatozoa which produce maximum fertilization percentage have been determined for the scallop *Pecten maximus* by GRUFFYDD and BEAUMONT (1970). The cylindrical 1-l culture enclosures used had a bottom area of 150 cm² and contained antibiotics: penicillin G (1670 I.U. mg⁻¹), 30 mg, and streptomycin sulphate (745 I.U. mg⁻¹), 50 mg. High sperm concentrations produce fewer larvae and higher percentages of abnormalities than lower concentrations (Fig. 5-84). Eggs fertilized and incubated at a concentration of 7 eggs cm⁻² bottom area yield very few abnormal larvae; however, if required, large numbers of normal larvae can be produced at 700 eggs cm⁻², even though a higher percentage of abnormal larvae must be accepted under these conditions.

In contrast to the high success of fertilization obtained in mass spawnings, gametes from an individual male and female *Crassostrea virginica* may fail to yield

a high fertilization efficiency. To some degree, the higher fertilization efficiency in mass spawnings may be attributable to the large diversity of gamete types (STILES and LONGWELL, 1973). There is evidence for incompatible genes in *C. virginica*, which prevent crossing of the gametes of very close relatives (LONGWELL and STILES, 1972). Once fertilization is achieved in the presence of excess sperm, gametic incompatibility appears to go hand in hand with polyspermy (LONGWELL and STILES, 1973b). Compatible crosses are less likely to become polyspermic, even in the presence of equally excessive numbers of spermatozoa.

Purification of newly fertilized eggs is an essential precaution for avoiding or reducing microbial infection. In order to free the eggs of debris, such as mucus, tissue pieces, excess sperm and blood cells, the egg suspension must be carefully passed through a screen or through sieves of appropriate mesh size. Thereafter, the eggs are transferred to shallow culture dishes containing filtered (sterilized) sea water.

For oyster eggs, the finest screen found practical by LOOSANOFF and DAVIS (1963a) had pore sizes averaging $44\ \mu\text{m}$ (average oyster-egg diameter: $50\ \mu\text{m}$). Best results were obtained with a series of sieves, the finest with a pore size of $44\ \mu\text{m}$, followed by coarser screens. Where the use of screens is impractical, the eggs can be purified by letting them settle and by subsequent decanting or siphoning off most of the fluid. Repeating this procedure several times leads to a satisfactory degree of purification.

For incubation of fertilized *Crassostrea virginica* eggs, LOOSANOFF and DAVIS (1963a) used filtered, ultra-violet-disinfected sea water of ca 23°C . About 30,000 eggs were placed in a 1-l Pyrex beaker and left undisturbed for 48 hrs. Usually, the eggs were incubated in non-aerated sea water; where experiments required aeration, rotating wheels or shakers (Chapter 2, p. 201) were employed. In general, hatching percentages were high. After 48 hrs, the young larvae, now protected by fully developed shells, were collected by screening the culture water through a sieve. The larvae retained were gently washed with sea water and placed in a clean jar.

Environmental and nutritional requirements

Light, temperature, salinity and water movement are among the environmental factors which have been shown to significantly affect development and growth of bivalve larvae. Responses of marine organisms to environmental factors have been reviewed in Volume I.

Light does not seem to exert significant effects on early larvae. However, critical investigations on responses of mollusc larvae to variations in irradiance remain to be conducted. In setting and metamorphosing larvae, light begins to affect both development and behaviour. Darkness is now preferred; originally photo-positive, the larvae increasingly exhibit negative phototaxis. According to WALNE (1974), illumination 24 hrs before settlement exerts a stimulating effect. During the settlement period, the number of spat increases as the illumination at the water surface is increased from 100 to 1000 lux. Responses to different photoperiods or to differences in light quality have not yet been investigated.

Temperature markedly affects larval development (Fig. 5-85). With *Ostrea edulis*, WALNE (1974) obtained good results in the range 14° to 25°C . He usually kept his cultures at about 22°C . Rates of food uptake as a function of temperature

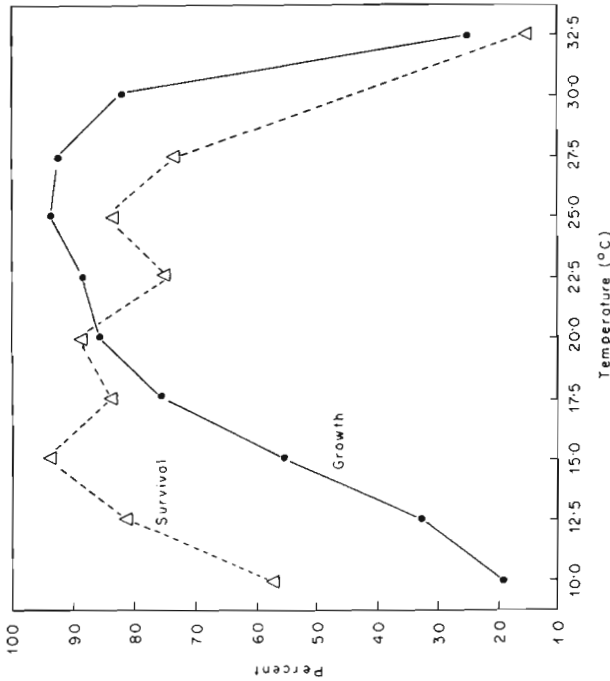
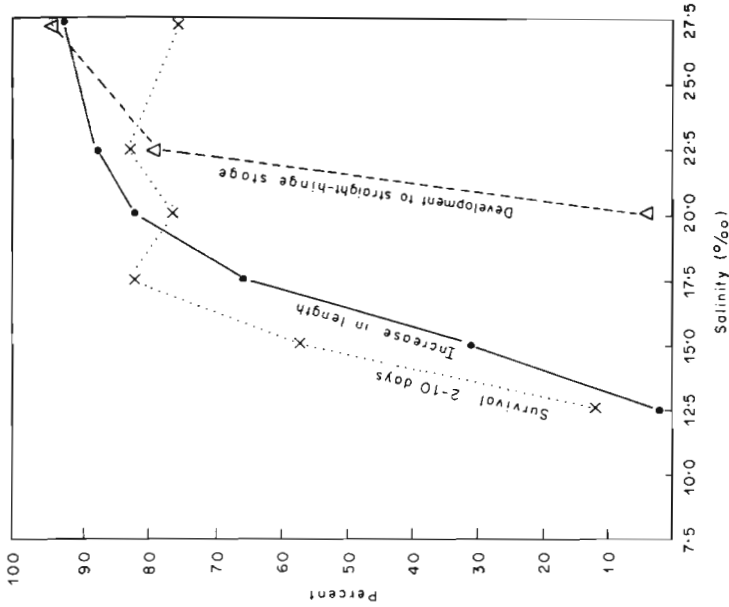

Fig. 5-85: *Ostrea edulis*. Temperature effects on larvae. Average rates of survival and growth (11 experiments), expressed as percentage increase in mean length. (After DAVIS and CALABRESE, 1969; modified; reproduced by permission of the *Biological Bulletin*.)

Fig. 5-86: *Mercenaria mercenaria*. Salinity effects on larvae. Survival from 2 to 10 days after hatching, increase in mean length, and percentage development to straight-hinge stage, 25° C. (After CALABRESE and DAVIS, 1970; modified; reproduced by permission of Biologische Anstalt Helgoland.)

are listed in Table 5-78. *Mercenaria mercenaria* has been grown from egg to settlement at constant temperatures ranging from 18° to 30° C (LOOSANOFF and co-authors, 1951). At lower or higher temperatures, mortality increases rapidly and structural abnormalities occur. For *Crassostrea virginica* eggs and larvae, LOOSANOFF and co-authors placed the lower critical temperatures near 17.5° C. At temperatures above 20° C, larval growth depended, to a large extent, upon the food provided. With *Chlorella* sp., a relatively poor food, *C. virginica* larvae grow less rapidly than when offered *Dunaliella euchlora*. At critical temperatures, thermal enzyme inactivation appears to interfere with proper digestion. At 10° C, for example, 12-day-old *M. mercenaria* larvae can ingest, but not digest, *Chlorella* sp., while naked flagellates can be both ingested and digested. At 20° C, *Chlorella* sp. can also be utilized. Similarly, larvae of *C. virginica*, kept at 20° C or lower, cannot utilize *Chlorella* sp., but at 25° C, some digestion seems to occur, and at 30° C, *Chlorella* sp. can apparently be utilized quite efficiently. According to LUTZ and co-authors (1969), acute temperature increase can stimulate setting in *C. virginica* larvae.

Table 5-78

Ostrea edulis. Food uptake as a function of temperature. Uptake of *Isochrysis galbana* at 20° C and 100 cells μl^{-1} has been taken to be 100 (After WALNE, 1974; reproduced by permission of Fishing News (Books) Ltd.)

Number of <i>Isochrysis galbana</i> cells μl^{-1}	Temperature (°C)				
	17	20	23	25	26
10	19	27	35	40	43
25	38	55	70	82	87
50	56	80	108	120	126
100	70	100	128	150	158

Salinity requirements and tolerances and responses to combined effects of temperature and salinity vary considerably among bivalves, and even among closely related species (e.g. DAVIS and CALABRESE, 1964; BRECKO and CALABRESE, 1969; CALABRESE, 1969; CALABRESE and DAVIS, 1970; CAIN, 1973; KINGSTON, 1974). Within one and the same species, larval responses to salinity often vary in different populations and as a function of concomitant conditions of temperature and other environmental factors. The effect of different salinities on *M. mercenaria* larvae is illustrated in Fig. 5-86.

In *Ostrea edulis* larvae, water depth may affect growth (Fig. 5-87). A water column of 80 to 220 cm has been shown to support higher growth rates than the conditions prevailing in shallow trays (WALNE, 1974). Some bivalves are rather resistant to short-term changes in pH (e.g. KUWATANI and NISHII, 1969); however, *Crassostrea virginica* spermatozoa and ova, released at pH 6.0 or 10.0, lose their vitality within 2 to 4 hrs (CALABRESE and DAVIS, 1969); PRYTHERCH (1934) found the presence of minute amounts of copper of importance to larval attachment of *C. virginica*.

A variety of culture enclosures have been used for rearing bivalve larvae, e.g. small beakers, Downing and McDonald jars used in fish hatcheries for incubation of

semi-buoyant eggs, lobster jars, earthenware jars, bins, 300-l fibre-glass containers or large outdoor concrete tanks. Most enclosures were cylindrical in shape.

WALNE (1974) reared larvae of *Ostrea edulis* in non-toxic polythene bins (58 cm high; diameter at top: 46 cm, at base: 39 cm), each containing 125 l of filtered sea water and covered by a lid through which 5 aeration lines extend to the bottom (Fig. 5-88). After adding 100,000 freshly liberated larvae of *O. edulis* to a 125-l bin, the culture medium is gently aerated and stirred by air bubbles dispersed from 5 air stones. The total amount of air received by each of WALNE's bins amounts to 200 l hr^{-1} . A comparison between the effects of gentle aeration and the use of plunger plates (Fig. 2-111, p. 200) revealed that the latter cracked the shells of 46% of the larvae (mean length: $218 \mu\text{m}$) after 48 hrs, while gentle aeration led to only 3.5% cracked shells.

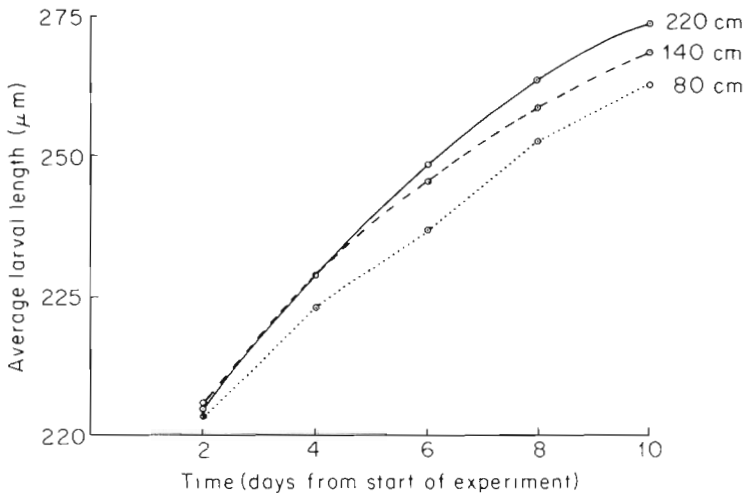

Fig. 5-87: *Ostrea edulis*. Larval growth as a function of water depth. Glass tubes of 10 cm diameter and 80, 140 and 220 cm water depths (holding 7, 14 or 21 l, respectively) served as culture enclosures. (Based on data published by WALNE, 1974).

Soft-glass or soft-plastic enclosures may leach substances which are dangerous to eggs and larvae (Chapter 7). Recently built concrete tanks must be exposed to sea water over a long period before bivalve larvae can be raised in them. For experimental purposes, Pyrex glass beakers (1000 to 1500 ml capacity) are recommended; they are non-toxic and can be easily cleaned and sterilized.

WALNE (1974) completely renewed the water in his bins every second day, siphoning it through a bag of nylon bolting cloth (mesh size: $124 \mu\text{m}$). When the water level had been lowered to about 2 cm, the nylon-bag filter was washed to remove adherent larvae, and the contents of the bin were tipped into a bowl. From here, the larvae suspension was poured through a sieve (nylon gauze glued on a section of PVC pipe). The larvae, surprisingly resistant to mechanical stress, are first washed through a sieve of $295 \mu\text{m}$ mesh, thus retaining large pieces of debris. A jet of water is then directed on them as they lie on a sieve of $124 \mu\text{m}$, thus washing the smaller particles away. At every water change, the larvae are briefly rinsed with

a hypochlorite-sea water solution (final concentration: 3 ppm of chlorine). This treatment is well tolerated; it reduces bacterial inoculations. Washed larvae are transferred to a clean bin containing freshly filtered sea water, antibiotics and food.

The food consumed by bivalve larvae under *in situ* conditions is insufficiently known. Presumably, small phytoplankton—preferably thin-walled or naked forms—constitute an important, if not the main food source. Detritus appears to be of little or no importance. In cultures, no food sources other than unicellular algae have been found satisfactory for larvae.

A comparison of the nutritional value of different unicellular algae for larvae of 20 cultured bivalve species led LOOSANOFF and DAVIS (1963a) to distinguish

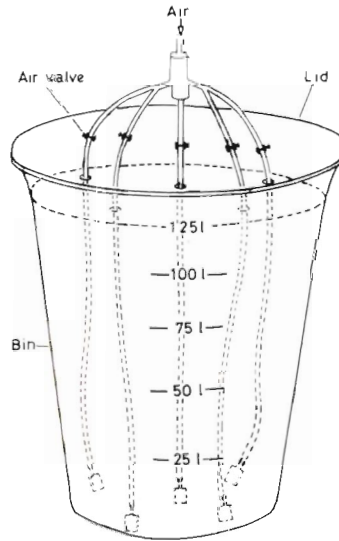

Fig. 5-88: Polythene bin used for mass cultivation of bivalve larvae. Note the 5 aeration lines; they end in aerators near the bin bottom. (Based on WALNE, 1974; reproduced by permission of Fishing News (Books) Ltd.)

three groups of larvae. The first group, represented by larvae of oysters of the genus *Crassostrea*, is able to utilize, during the early straight-hinge stage, only a few of the many food algae offered (DAVIS, 1953; DAVIS and GUILLARD, 1958). The second group includes the larvae of *Mercenaria mercenaria* and *Mytilus edulis*, and seems to be able to utilize most of the algae tested, provided these are small enough to be ingested. The third (intermediate) group includes larvae of larviparous oysters of the genus *Ostrea*. This group is much less restricted in its food requirements than the larvae of *Crassostrea* species; however, it grows less well on some algae than larvae of the second group. The food values of unicellular algae for larvae of *Ostrea edulis* are listed in Table 5-79. According to WALNE (1965, 1970b, 1974), the food values vary as a function of the culture conditions to which the algae had

Table 5-79

Food value of different unicellular algae for *Ostrea edulis* (Based on information presented by WALNE, 1974)

Algae	Growth response	Food value	Remarks
Chlorophyceae			
<i>Coccomyxa</i> sp.	Little or no growth	Low or none	Thick cell wall may resist digestion
<i>Chlorella</i> sp.	Little or no growth	Low or none	Thick cell wall may resist digestion
<i>Chlorella stigmatophora</i>	Little or no growth	Low or none	—
<i>Chlorella marina</i>	Little or no growth	Low or none	—
<i>Nannochloris atomus</i>	Supported spat production in 2 out of 9 experiments	Low	—
<i>Dunaliella tertiolecta</i>	Presumably does not support growth for a long period	Low	—
Prasinophyceae			
<i>Pyramimonas grossi</i>	A series of 4 experiments all produced spat	Presumably high	Difficult to mass culture
<i>P. ovata</i>	Good growth	High	—
<i>Tetraselmis suecica</i> (syn: <i>Platymonas</i>)	Very good growth	Very high	Standard food organism for cultured oyster larvae; offered in concentrations of 50 cells μl^{-1}
<i>Micromonas pusilla</i>	Good growth	High	—
Haptophyceae			
<i>Isochrysis galbana</i>	Very good growth	High	Standard food organism for cultured oyster larvae
<i>Dicrateria inornata</i>	Very good growth	Very high	Difficult to mass culture
<i>D. gilva</i>	Very good growth	Very high	Difficult to mass culture
<i>Chrysochromulina</i> spp.	Presumably good growth	Presumably high	Difficult to mass culture
<i>Prymnesium parvum</i>	No growth	None	Possibly poisonous
Chrysophyceae			
<i>Chromulina pleiades</i>	Good growth	High	Not easy to culture
<i>Monochrysis lutheri</i>	Good growth	High	—
Cryptophyceae			
<i>Cryptochrysis rubens</i>	Medium growth	Medium	Not easy to culture
<i>Cryptomonas acuta</i>	Medium growth	Medium	Not easy to culture
<i>Hemiselmis rufescens</i>	Poor to medium growth	Low to medium	—
<i>H. virescens</i>	Poor to medium growth	Low to medium	—
Cyanophyceae			
<i>Synechococcus elongatus</i>	No growth	None	—

Table 5-79—Continued

Algae	Growth response	Food value	Remarks
Bacillariophyceae (diatoms)			
<i>Phaeodactylum tricornutum</i>	Poor to medium growth	Low to medium	—
<i>Chaetoceros calcitrans</i>	Very good growth	Very high	Difficult to mass culture
<i>Cyclotella nana</i>	Very good growth	Very high	Difficult to mass culture
Mixed algal foods			
<i>Isochrysis galbana</i>	} Very good growth	Very high	} Mixed food (any 2 of the 3 species listed) supports larval growth better than any single algal food
<i>Tetraselmis suecica</i>			
<i>Chaetoceros calcitrans</i>			

been exposed (e.g. nutrients, temperature, season). There is a tendency for a particular group of algae to be either good or poor food for oyster larvae. While several single-alga populations can support bivalve larvae, mixtures of different algae often produce better results. Larvae of *O. edulis* and *Crassostrea virginica* grow well on *Isochrysis galbana* and *Tetraselmis suecica*. A mixture of 50 cells μl^{-1} of *I. galbana* and 5 cells μl^{-1} of *T. suecica* has supported very good growth. The food values of unicells for larvae of the clam *Mercenaria mercenaria* and the oyster *Crassostrea virginica* have been investigated by DAVIS and GUILLARD (1958). Their main results are summarized in Table 5-80.

Table 5-80

Food value of different unicellular algae for larvae of *Mercenaria mercenaria* and *Crassostrea virginica* (Based on information presented by DAVIS and GUILLARD, 1958)

<i>Mercenaria mercenaria</i>		<i>Crassostrea virginica</i>	
Algae	Food value	Algae	Food value
<i>Chlorococcum</i> sp.	High	<i>Chromulina pleiades</i>	High
<i>Dicrateria</i> sp.	High	<i>Dicrateria inornata</i>	High
<i>Isochrysis galbana</i>	High	<i>Hemiselmis rufescens</i>	High
<i>Monochrysis lutheri</i>	High	<i>Isochrysis galbana</i>	High
<i>Platymonas</i> sp.	High	<i>Monochrysis lutheri</i>	High
<i>Carteria</i> sp.	Medium	<i>Pyramimonas grossi</i>	High
<i>Chlamydomonas</i> sp.	Medium	<i>Chlorella</i> sp.	Medium
<i>Chlorella</i> sp.	Medium	<i>Chlorococcum</i> sp.	Medium
<i>Cyclotella</i> sp.	Medium	<i>Cryptomonas</i> sp.	Medium
<i>Dunaliella euchlora</i>	Medium	<i>Cyclotella</i> sp.	Medium
<i>Dunaliella</i> sp.	Medium	<i>Dunaliella euchlora</i>	Medium
<i>Olisthodiscus</i> sp.	Medium	<i>Dunaliella</i> sp.	Medium
<i>Phaeodactylum tricornutum</i>	Medium	<i>Phaeodactylum tricornutum</i>	Medium
<i>Skeletonema costatum</i>	Medium	<i>Platymonas</i> sp.	Medium
<i>Stichococcus</i> sp.	Medium		
<i>Rhodomonas</i> sp.	Medium		

Algal food values depend on the ability of the bivalve involved to digest the algal cell membrane. Thick cell membranes are often more resistant to digestion than thin membranes. The digestive capacity of the bivalve is determined by its enzymes and their activities which, in turn, depend on the endogenous (e.g. age) and exogenous (especially temperature) factors. In addition, the food value of the algae may become a function of algal metabolite release. Especially in high food concentrations, and with little or no water exchange, metabolite concentrations may attain limiting or toxic levels. If the food algae become heavily infested with toxic bacteria, even otherwise non-toxic algae may acquire toxic qualities. Protein, amino-acid, mineral, vitamin and trace-element requirements of oyster larvae have not yet been investigated in detail.

The colour of the algal food greatly affects the colour of the bivalve larvae. By feeding larvae differently coloured food organisms, it was possible, especially during early straight-hinge stages, to change the soft bodies' colour within hours (LOOSANOFF AND DAVIS, 1963a).

Larvae of *Mercenaria mercenaria* can be grown on pure cultures of any of the following algae: *Chlamydomonas* sp., *Chromulina pleiades*, *Isochrysis galbana* and *Chlorella* sp. (DAVIS and LOOSANOFF, 1953). They exhibit selectivity in feeding, both mechanical-quantitative and chemical-qualitative. According to LOOSANOFF and DAVIS (1963a), *M. mercenaria* larvae are able to select certain food algae from a mixture of several phytoplankton forms. When offered a mixture of *Chlamydomonas* sp. and *Porphyridium* sp., for example, the larvae ingested the much larger *Chlamydomonas* and rejected the smaller *Porphyridium* (LOOSANOFF and co-authors, 1953a).

The 'LOOSANOFF-DAVIS method' of cultivating oyster larvae has sometimes been compared with the 'WELLS-GLANCY method' which follows WELLS (1920, 1926, 1927) and uses raw sea water that has been centrifuged to eliminate zooplankton, large phytoplankters and large detritus particles. The raw sea water is stored for ca 24 hrs in shallow outdoor plankton-growing tanks, covered by a translucent roof, and resulting plankton blooms are fed to the cultured bivalves. The advantage of the (patented) 'WELLS-GLANCY method' are (i) natural food supply, (ii) inexpensive production of algal food, (iii) little requirement for much technical skill. The disadvantages are (i) little or no control of food-organism quality and quantity, (ii) lack of disease, predator and water-quality control.

The quantity of food ingested by cultured bivalve larvae has been examined by several investigators. According to LOOSANOFF and DAVIS (1963a), larvae of *Mercenaria mercenaria* are able to regulate the amount of food taken up, and thus to survive in higher densities of food algae. In continuously overfed cultures, the larvae often develop structural abnormalities which may render them unable to ingest more food. The quantity of food removed by *Ostrea edulis* larvae in 24 hrs has been estimated by WALNE (1974), who obtained the values listed in Table 5-81. The daily amount of food consumed increases from about 20,000 *Isochrysis galbana* cells in newly hatched larvae to 60,000 cells shortly before metamorphosis. WALNE calculated the minimum number of *I. galbana* cells which the larvae must have eaten by dividing the radio-activity recorded in the larvae by the known radio-activity of the algal cells. On the basis of these calculations, a small *O. edulis* larva consumes 5000 to 10,000 *I. galbana* cells day⁻¹; the small *Micromonas minutus*

is consumed at 16,000 to 23,000 cells day⁻¹; the large *Dunaliella tertiolecta* at 400 to 1200 cells day⁻¹.

Optimum food concentrations, i.e. the population densities of food algae which support maximum survival and growth of bivalve larvae, depend on algal size. When LOOSANOFF and co-authors (1953a) fed large *Chlorella* sp. (ca 8 μm diameter) to larvae of *Mercenaria mercenaria*, optimum food concentration was approximately 50,000 cells ml⁻¹. In the case of smaller *Chlorella* sp. (ca 3 μm diameter), about 400,000 cells ml⁻¹ were required to achieve the same result. If the cell densities become too high, larvae of *M. mercenaria* can be killed. When exposed to a density of 300,000 cells ml⁻¹ of the large *Chlorella* sp., 90% of the larvae were killed within a few days; at 500,000 cells ml⁻¹, all larvae died within 24 hrs. However, when given the small *Chlorella* sp., the larvae grew comparatively well in all concentrations, even as high as 750,000 cells ml⁻¹. Whether only cell sizes—or also other properties of the two *Chlorella* forms—are responsible for the different results obtained remains to

Table 5-81

Ostrea edulis. Number of food algae removed by larvae within 24 hrs. Ca 22° C (After WALNE, 1974; modified; reproduced by permission of Fishing News (Books) Ltd.)

Time (days after beginning of experiment)	Number of <i>O. edulis</i> larvae 12 l ⁻¹	Average shell length (μm)	Number of <i>Isochrysis galbana</i> cells added μl^{-1}
1	529,200	193	0
3	483,000	206	761
6	461,000	237	1153
9	432,000	266	1200
12	464,000	280	1095
15	412,000	289	1428

be examined. Critically high cell concentrations may affect the larvae mechanically by interference with larval swimming and feeding, as well as chemically, e.g. via external metabolites or other consequences of metabolism (see also p. 911).

Ostrea edulis larvae, offered ³²P-labelled *Isochrysis galbana* at different cell concentrations, exhibit maximum food ingestion at 300 cells μl^{-1} (Fig. 5-89). However, as WALNE (1965) has pointed out, it is not practicable to rear larvae at such high population densities because of heavy pseudofaeces production and subsequent fouling. In a series of experiments, food concentrations of about 50 cells μl^{-1} gave good results in terms of growth and culture management. Comparable values for the small sized *Micromonas minutus* were 130 cells μl^{-1} , for *Dunaliella tertiolecta*, 25 cells μl^{-1} .

Feeding seven different-sized groups of *Crassostrea virginica* larvae various concentrations of *Isochrysis galbana*, RHODES and LANDERS (1972) determined the population density of *I. galbana* which supported maximum growth for each larval size group. The optimum concentration increased with increasing larval length and ranged from 2.5 μl of packed cells l⁻¹ of algal culture for larvae 74 μm long to

32.5 μl for larvae 246 μm long (Table 5-82). RHODES and LANDERS found it more efficient to increase the *I. galbana* concentration as the larvae grew than to feed the larvae at constant rates. Chemical analysis by D. M. COLLYER (*in*: WALNE, 1974) revealed that even standard culture methods may yield algae of a given species that vary in their chemical composition. Thus far, no consistent correlation between the chemical composition of a food alga and its food value to oyster larvae has become apparent.

A variety of other foods have been offered to bivalve larvae, usually with limited or no success. Organic detritus could be utilized neither by larvae of *Mercenaria mercenaria* (LOOSANOFF and co-authors, 1951), nor by those of oysters (DAVIS, 1953). A colourless flagellate which grew vigorously in sea water enriched with starch (which, in turn, encouraged the growth of bacteria, the food of the flagellate) may have been suitable as food, but WALNE (1974) found it difficult to avoid adding

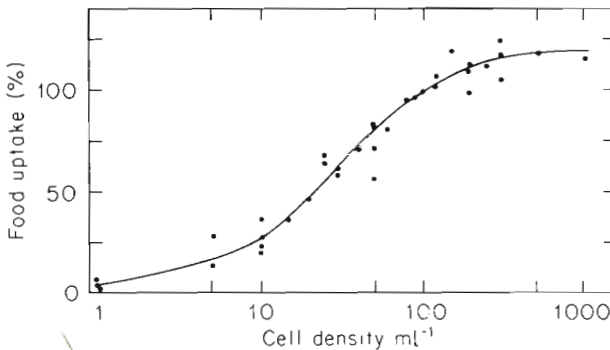

Fig. 5-89: *Ostrea edulis*. Uptake by larvae of ^{32}P -labelled *Isochrysis galbana* offered at different cell densities. The value obtained at 100 cells μl^{-1} was taken as ca 100. About 22° C. (After WALNE, 1974; modified; reproduced by permission of Fishing News (Books) Ltd.)

some of the culture medium to the larval container. The result was heavy microbial growth, inimical to larval development. Neither baker's yeast (e.g. LOOSANOFF, personal communication *in*: HIDU and UKELES, 1962; LUND, 1973; WALNE, 1974) nor yeast isolated from sea water was able to support growth of oyster larvae.

Of the dried foods examined thus far, only dried unicellular algae yielded satisfactory results. Finely pulverized multicellular algae such as species of *Ulva* and *Laminaria* supported growth of *Mercenaria mercenaria* larvae to metamorphosis (LOOSANOFF and DAVIS, 1963a). However, it was difficult to grind the algae into particles small enough for ingestion, and to prevent the suspended material from quickly settling on the bottom of the culture enclosures. Hence, the algal particles soon became unavailable to the larvae and tended to foul the culture water. Encouraging results have been obtained with freeze-dried *Dunaliella euchlora* and *Isochrysis galbana* (HIDU and UKELES, 1962; see also CHANLEY and NORMANDIN, 1960). These dried algae supported growth of *M. mercenaria* larvae comparable to that obtained with live algae. Heat-dried *Scenedesmus obliquus* also gave good survival and growth. Dried *S. obliquus* and *Chlorella* sp. (e.g. 0.02 ml packed food l^{-1}

of culture water day⁻¹), kept suspended (plunger plate, horizontal-action paddle), and offered together with Sulmet (sodium sulphamethazine) for controlling bacterial growth, have supported *M. mercenaria* larvae almost as effectively 'as our best live food organisms' (LOOSANOFF and DAVIS, 1963a, p. 67). In some experiments, the larvae grew as rapidly on freeze-dried *Isochrysis galbana* as larvae in the control cultures receiving the same quantities of live *I. galbana*. In contrast, preserved unicells (dried, freeze-dried, spray-dried, vacuum-dried) did not support significant growth in larvae of *Ostrea edulis* (WALNE, 1974).

Table 5-82

Crassostrea virginica. Average length increments (μm) of larvae after being fed different concentrations of food algae (*Isochrysis galbana*) (After RHODES and LANDERS, 1972; reproduced by permission of National Shellfisheries Association)

Food-alga concentration ($\mu\text{l l}^{-1}$)	Initial larval length (μm)						
	74	80	105	137	168	200	255
60.0							9.7
50.0							17.1
45.0						38.1	16.8
40.0						38.1	11.9
35.0					20.5	35.6	16.3
30.0					27.6	38.1	17.6
25.0				43.1	30.6	37.7	11.1
20.0			41.9	42.9	34.2	26.7	
17.5			43.8	41.9	33.6	28.0	
15.0		17.0	45.1	43.6	33.2		
12.5		13.2	41.7	39.3	27.5		
10.0	11.7	14.7	39.0	25.8			
7.5	12.3	17.7	34.7	15.5			
5.0	15.0	14.2	18.6				
3.8	15.6	12.3					
2.5	14.6	12.7					
1.2	7.5						
0.6	5.6						
Unfed	2.2	0.0	0.0	0.0	2.3	3.4	0.0

A dry-formula diet of known and reproducible chemical composition and with a long shelf-life would, of course, be ideal for nutritional studies on bivalves and for solving a variety of ecological problems. However, it seems that the road is long toward developing a dry formula which meets all essential requirements. CARRIKER (1956) fed larvae of *Mercenaria mercenaria* with commercial cereal pabulum flakes and obtained only very limited and sporadic success. DUNATHAN and co-authors (1969) fed *Crassostrea virginica* finely ground cornmeal, brown rice, barley, hominy, cornstarch, millet, torula yeast, crabmeal, whole wheat, glucose, cellulose, aggregated glucose, *Gracilaria sjoelstedtii* and combinations of finely ground cornmeal/crabmeal, cornmeal/yeast and cornmeal/brown rice. The best results were obtained with cornmeal and rice. LUND (1973) tested brewer's yeast and four artificial dry

diets. The best diets were composed of yeast, fish meal, soybean meal, whey, rice bran and vitamins. The components of the dry rations were bound with starch or alginate, and dried to form particles of low solubility in sea water. However, without supplemental algal food (*Isochrysis galbana*), the larvae of *Crassostrea gigas* failed to grow or set well. According to WALNE (1974), dried, finely-powdered beef liver yielded promising results in *Ostrea edulis* larvae, but the uneaten portions contaminated the culture water.

JONES and co-authors (1974), JONES and GABBOTT (1976) and GABBOTT and co-authors (in press) demonstrated the feasibility of feeding marine small-particle consumers, including bivalves, micro-encapsulated diets (see also pp. 583, 1199). The walls of the microcapsules must be broken down in the gut, either by digestive enzymes or by a change in pH. *Mytilus edulis* and *Crassostrea gigas* have been sustained on nylon-protein microcapsules and on capsules containing a carbohydrate-protein complex in the wall, using a protein-starch-cholesterol diet (JONES and GABBOTT, 1976; JONES and co-authors, in press) or a carbohydrate-rich glycopeptide fraction (2% w/v) derived from (egg white) ovomucoid. For further developments, polymer capsules with cellulose walls prepared by a secondary emulsion process deserve particular attention (GABBOTT and co-authors, in press). Full enzymatic digestion of microcapsules in the bivalve's stomach may be facilitated by preparing starch or other carbohydrate derivatives with free $-NH_2$ or $-NHR$ groups to form a cross-linked nylon membrane. Starch will be hydrolysed by carbohydrases, and simple enzyme tests can be carried out on the derivatives before and after incorporation into the capsule membrane. Although the ultimate aim is a completely artificial diet, the next step should be the development of protein-starch-cholesterol (and fatty acid) diets providing bulk nutrients, and to supplement these by unicellular algae accounting for essential micronutrients such as vitamins.

In summary, a variety of unicellular algae can serve as adequate food for bivalve larvae. While the food sources utilized under natural conditions in the sea are still largely unknown, algae such as *Isochrysis galbana*, *Monochrysis lutheri*, *Dicrateria inornata*, *D. gilva*, *Chromulina pleiades*, *Hemiselmis rufescens*, *Pyramimonas grossi*, *P. ovata*, *Platymonas succica*, *Chlorococcum* sp., *Chaetoceros calcitrans*, *Cyclotella nana*, *Tetraselmis succica* have supported good growth and high percentages of metamorphosis in most bivalves examined. In addition to live algae, freeze-dried powdered algae may support good growth. The dried algae must be kept suspended and fouling be counteracted (e.g. by antibiotics). For experiments on nutritional dynamics, it is essential that the food algae be cultivated under known, controlled, and—if necessary—standardized conditions (for details consult Chapter 4). Other food sources tested produced less satisfactory results or failed to support the larvae. Artificial dry formulae, if available, are likely to be useful as supplementary diets rather than as sole food source, not least because of the problems involved in proper suspension and antifouling procedures.

Growth rates of bivalve larvae depend (in addition to nutrition) on light, temperature, salinity, water movement, turbidity and dissolved gases. In a few cases, relationships between larval growth and activities of co-existing organisms have been demonstrated. WALNE (1970a), for example, reports that a bloom of *Phaeocystis pouchetti* reduced the growth of *Ostrea edulis* larvae in a river, and that bacteria

have caused larval cultures to collapse. According to HELM and SPENCER (1972), aeration significantly improved growth of *O. edulis* larvae. Each type of culture dish used had an optimum air-flow requirement which increased with its water volume.

The literature abounds with time scales of bivalve larval growth. At 23° C, larvae of *Crassostrea virginica*, for example, have been reared to metamorphosis in 18 days; at 30° C, well-fed larvae metamorphose 10 days after fertilization. At 18° C, *Mercenaria mercenaria* larvae begin to metamorphose after 16 days; at 30° C, after 7 days (LOOSANOFF and DAVIS, 1963a). Growth rates may vary considerably in different species and even within a given species or population (e.g. LOOSANOFF and co-authors, 1951; IMAI and co-authors, 1954).

Growth rates of bivalve larvae are also affected by crowding. While some species tolerate crowding of up to 50 or 100 larvae ml⁻¹ (e.g. *Mercenaria mercenaria*), larvae of other species are much more sensitive to high population densities. In general, heavily crowded cultures require more attention and are more susceptible to environmental stress and diseases than less densely populated cultures. Slower growth in crowded cultures has been attributed to (i) reduced availability of food for larvae, (ii) frequent collisions between larvae, (iii) increased levels of metabolic end products.

Experiments revealed that the mean length of 10-day-old larvae of *Mercenaria mercenaria* in cultures containing 6, 13, 26 or 52 individuals ml⁻¹ was 162, 156, 151 and 144 μm, respectively (LOOSANOFF and co-authors, 1955). *Crassostrea virginica* larvae which were cultured, at an age of 24 hrs, at densities of about 0.6, 2.8, 18.5 and 33 ml⁻¹, and all provided with 50,000 cells of *Chlorella* sp. ml⁻¹, showed an inverse relationship between crowding and growth rates (DAVIS, 1953). Considering these and related findings, LOOSANOFF and DAVIS (1963a) conclude that the danger from overcrowding in well-maintained cultures of bivalve larvae may not be as acute as often assumed. However, overcrowding is undesirable, especially in experiments which are conducted in order to assess normal *in situ* performances and where maximum growth rates are essential.

Antibiotic treatment

As has already been pointed out, micro-organisms, especially bacteria, may interfere with larval development or affect setting. The first aspect is dealt with below, the second in the next sub-section.

Heavy bacterial growth is detrimental to oyster larvae. Two groups of bacteria may be distinguished: (i) non-pathogenic decomposers which, if too numerous, depress larval growth and may sometimes be lethal, and (ii) pathogenic forms which may cause rapid death of whole cultures. Decomposers tend to attain critically high densities if the water quality deteriorates, especially if food remains and metabolic waste products are allowed to accumulate. The main countermeasure employed for combating extensive microbial growth involves antibiotics. In general, a mixture of antibiotics is more effective than single antibiotics. WALNE (1974; see also 1956, 1958) adds 1 ml of a stock solution of antibiotics to each litre of culture medium. The stock solution is prepared by dissolving 15 g of penicillin G sodium salt (1670 I.U. mg⁻¹) and 33.5 g of streptomycin sulphate (745 I.U. mg⁻¹) in distilled water (final volume 500 ml). In the presence of this antibiotic mixture, larval growth rate and

number of spat increase. Other antibiotics, such as ilotycin, colomycin and ceporin, give similar or better results, but are more expensive.

While antibiotics play a significant role in the cultivation of marine animals (Chapter 2, pp. 383, 385; Chapter 5.11; this chapter, p. 997, p. 1062), they may interfere with essential biological processes of the animals cultivated, modify animal-micro-organism relations and reduce the animals' resistance to pathogenic micro-organisms. The latter fact must be considered especially detrimental in cases where oyster spat are later to be transferred to *in situ* conditions. Since billions of oyster larvae can be produced without much difficulty, it would be worthwhile to investigate the possibilities of increasing their resistance to microbial activities via selection and immunity principles. Maximum larval survival rates are scarcely an achievement if followed by high rates of spat mortality.

Pathogenic micro-organisms (KINNE (in press)) cause rapid tissue disintegration in oyster larvae and kill whole cultures within a few hours. The identity and characteristics of microbial agents which have been repeatedly reported to cause dramatic detrimental effects in cultures of oyster larvae are not known. The bacteria present in mass cultures of six different genera of algae used as food for bivalve larvae have been isolated and identified by MURCHELANO and BROWN (1969). Oysters generally contained the same bacterial genera as the sea water in which they were grown (MURCHELANO and BISHOP, 1969; see also GRAS, 1971)

The effects of selected bacteria on healthy embryos and larvae of *Crassostrea virginica* have been examined by BROWN (1973), who isolated 156 bacterial strains from moribund larvae. Most of these isolates were nonpigmented, motile, Gram-negative rods, sensitive to chloramphenicol and neomycin (species of *Pseudomonas* and *Vibrio*). Twenty of the bacterial strains tested caused morphological abnormalities, decreased growth and/or increased mortality in developing larvae.

Metamorphosis and setting

The onset of metamorphosis (spatfall) of bivalve larvae is controlled by a number of factors, of which age, light, temperature, nutrition and availability of a suitable substratum seem to be the most important. Although setting in *Mercenaria mercenaria* occurs most commonly when the larvae have reached a length of 200 to 210 μm , the largest larvae do not always metamorphose first.

Metamorphosis may not only be delayed by unfavourable circumstances, but also hastened or interrupted. The environmental conditions responsible for the latter two response patterns are insufficiently known. Presumably, the great range of individual differences in metamorphosis timing among larvae of one and the same species parallels genetic differences in environment-organism interrelationships, conveying to the species involved a considerable degree of flexibility in its response patterns.

When 'eyed' larvae appear, WALNE (1974) hangs two strings of mussel shells near the water surface. When these test shells show that spatfall is beginning, the main larvae collectors are introduced. They consist of sheets of black, matt-surfaced PVC moulded to the size and shape of earthenware tiles used on French oyster grounds (Fig. 5-90). Tied together in bundles of 8 or 16, the PVC tiles stand on the bottom of the bin, a bundle of 16 nearly reaching the surface. According to WALNE, spatfall continues for about 7 days. Thereafter, the collectors are placed in coarsely filtered

sea water, enriched with algal food, but without antibiotics. The best results have been obtained by standing the collectors in 400-l fibre-glass tanks with recirculating sea water filtered through a 68- μm mesh and containing either 50 *Isochrysis galbana* cells μl^{-1} or 2.5 *Tetraselmis suecica* cells μl^{-1} .

Solid substrata, such as tiles, mollusc shells and rocks, are rendered more attractive to setting bivalve larvae after (i) exposure to sea water (leaching of toxic or unattractive substances from newly submerged materials); (ii) establishment of a slimy film, consisting of bacteria, protozoans, diatoms and related micro-organisms; (iii) spat or adult settlement; (iv) painting with extracts of bivalve faeces or bivalve meat, preferably of conspecifics; (v) treatment with chemicals. Metamorphosing larvae which approach or crawl about on potential substrates apparently examine the physical structure and the 'smell' of the substratum before final attachment.

The earthenware tiles used as setting substrata ('spat collectors') in France have been adopted by many bivalve cultivators. U-shaped and about 30 cm long by 10 cm wide, the tiles are bundled (Fig. 5-90) and dipped in a lime mortar for a few weeks

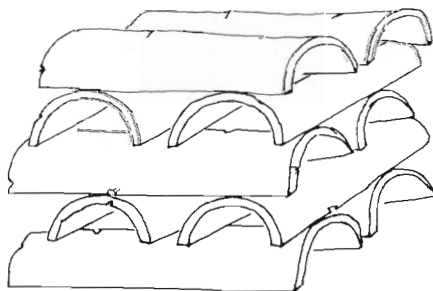

Fig. 5-90: Stacked earthenware tiles used as setting substrates (spat collectors) for larvae of *Ostrea edulis*. (Based on various sources.)

before use. This aids in the removal of spat when they reach thumbnail size and are transferred (e.g. to fattening grounds). WALNE (1974) mixes 1.5 parts of freshly slaked lime, 2 parts of sand, 1 part mud and sufficient water to give the consistency of thin oil, and covers the tiles with a coat of 2 to 3 mm thickness. Examples of other successful spat collectors are sheets or meshes of non-toxic plastics and cement-coated light material (e.g. egg cartons).

Larvae of numerous sessile marine invertebrates have been shown to be attracted by conspecifics. Ecologically, such attraction appears beneficial to the species involved, because it directs larvae to sites with environmental conditions which have supported conspecifics at least for some time, and hence, can be expected to do so in the future. Substrata covered with extracts of oyster faeces or oyster meat have been shown to attract significantly more larvae than comparable, untreated substrata. LOOSANOFF and DAVIS (1963b) collected oyster faeces from adult individuals, dried them, and then mixed them in a 3:1 volume ratio with Portland cement to make a concrete panel of ca 10 × 5 × 0.7 cm thickness. Other panels of similar size were made with dried silt or with washed and dried sand. After seasoning the panels to minimize potentially detrimental effects of the fresh cement, they were

exposed to water containing ready-to-metamorphose oyster larvae. In several tests, the panels consistently attracted more spat than control panels (W. LANDERS, personal communication *in*: LOOSANOFF, 1971). WALNE (1966) coarse-filtered oyster meat, homogenized in 100 ml of sea water, and centrifuged the homogenate before painting the extract on the substratum. On painted, frosted glass plates, allowed to dry prior to submersion, spatfall was 3.6 times heavier than on untreated control plates. Painted plates can be stored for several weeks without losing their attractiveness to larvae. However, after heating (300° C) or exposure to such substances as sodium hypochlorite or caustic soda, the attractiveness is rapidly lost. Settling larvae of *Ostrea edulis* were more attracted to extracts prepared from adult conspecifics than from heterospecifics (*O. lutaria*, *Crassostrea gigas*, *C. angulata* or *Mytilus edulis*). Such specificity in substrate attractiveness may be of ecological significance in interspecific competition and distribution.

According to WALNE (1974), a precipitate was obtained if 2.4 molar ammonium sulphate was added to the standard extract. Containing about 75% of the protein in the extract, this precipitate can be dissolved in a standard buffer solution. After dialysis to remove the ammonium sulphate, the purified extract retained about 70% of the original attractiveness. Compared to the original extract, the purified extract is less stable at room temperature, but it can be painted on plates and dried without loss of activity.

Oyster-shell liquor attracts settling *Ostrea edulis* larvae (BAYNE, 1969), and *Crassostrea virginica* spat inside 'larval-proof' mesh bags stimulate mature larvae to settle outside the bags, indicating the involvement of a water-borne pheromone (HIDU, 1969). HIDU and co-authors (1969) found oyster-shell liquor, as well as water filtered by adult *C. virginica*, to stimulate larval setting. From the shell liquor of *C. virginica*, VEITCH and HIDU (1971) partially purified a substance which stimulates gregarious setting of *C. virginica* larvae (Table 5-83). The substance has been shown to be a protein with a molecular weight of >100,000 Daltons. Enzymatic or alkaline hydrolysis of the protein frees thyroxine and, possibly, 3,5-diiodotyrosine and triiodotyrosine. While these freed materials also stimulate larval setting, much higher concentrations are required as compared to the original compound protein.

Oyster shells serving as setting substrata have been treated by dipping them in chemicals. MACKENZIE and co-authors (1961) used chlorinated benzenes, such as Polystream. They report that Polystream-treated oyster shells are more resistant to fouling and attract almost twice as many larvae as untreated shells. After conducting commercial-scale field experiments with Polystream-treated shell cultch, CASTAGNA and co-authors (1969) concluded that such treatment may be economically feasible in aquaculture operations.

CRANFIELD (1970) found the intensity of *Ostrea lutaria* settlement to depend both on the substratum surface and the surface angle. The latter might have affected turbulence differences. There is evidence that water movement close to a settling surface influences bivalve larvae which are about to settle.

In summary, the exact nature of the attractive agent is not yet known; we do know, however, that its active principle is often contained in conspecifics and close relatives. The stimulating factor obtained from oyster-shell liquor is non-dialyzable, precipitated by 50% acetone, and salted out of solution by 66% saturation with ammonium sulphate. Since thyroxine can be liberated from this material by digestion with proteolytic enzymes or by alkaline hydrolysis, VEITCH and HIDU (1971)

Table 5-83

Crassostrea edulis. Attraction of larvae (number of larvae set per beaker) by fresh oyster-shell liquor (FOSL) and various other substances. FOSL was very effective in stimulating setting of mature larvae (After VEITCH and HIDU, 1971; modified; not copyrighted)

Control	Test fraction	Test/control	t value	Degrees of freedom	Significance level	Remarks	
Fresh oyster-shell liquor (10 ml per beaker)							
96.8	180.0	1.85	25.5	18	.01	—	
12.2	38.4	3.14	5.5	17	.01	—	
16.3	91.4	5.60	11.37	18	.01	—	
10.4	45.5	4.37	20.60	18	.01	—	
27.5	63.2	2.29	8.84	18	.01	—	
60.6	95.4	1.57	4.85	18	.01	—	
10.7	21.0	1.96	9.26	18	.01	—	
12.9	27.0	2.09	4.62	18	.01	—	
10.7	21.0	1.96	9.56	18	.01	—	
77.3	104.4	1.35	4.00	18	.01	—	
48.3	99.3	2.05	8.55	18	.01	—	
21.7	36.3	1.67	8.30	18	.01	—	
Dialyzed fresh oyster-shell liquor							
Dialyzed material	40.5	104.4	2.6	5.5	12	.01	Sample size equivalent to 10 ml of FOSL
Dialyzate	96.8	91.4	.94			N.S.	Sample size equivalent to 10 ml of FOSL
Cascade filtration samples*							
100 KR	12.9	29.6	2.29	3.17	18	.01	532 μg protein beaker ⁻¹
50 KR	12.9	12.4	.96	.14	18	N.S.	50 μg protein beaker ⁻¹ No significant stimulation produced by any other fraction of this procedure
Acetone (50% precipitate of FOSL)							
No. I	114.1	175.1	1.53	5.8	21	.01	155 μg protein beaker ⁻¹
No. II	114.1	154.1	1.35	4.9	21	.01	25 μg protein beaker ⁻¹
Ammonium sulphate precipitate of 100 KR							
100 KR66	21.7	37.2	1.71	7.67	18	.01	594 μg protein beaker ⁻¹
100 KR S	21.7	26.4	1.22	2.59	18	N.S.	50 μg protein beaker ⁻¹
Miscellaneous test materials							
Thyroxine	21.7	32.2	1.48	3.60	18	.01	1.0 mg beaker ⁻¹
Tyrosine	48.3	67.7	1.40	3.40	18	.01	5.0 mg beaker ⁻¹
3-Iodo-tyrosine	48.3	67.2	1.39	4.84	18	.01	1.0 mg beaker ⁻¹
3,5-Diiodo-tyrosine	48.3	76.2	1.58	27.10	18	.01	1.0 mg beaker ⁻¹
Iodinated casein	48.3	66.6	1.38	3.54	18	.01	10.0 mg beaker ⁻¹
Iodinated casein	27.5	47.5	1.73	4.65	18	.01	2.0 mg beaker ⁻¹
Iodinated casein	60.6	61.5	1.01			N.S.	1.0 mg beaker ⁻¹

* 100 KR: substances of molecular weight 100,000 or more, ultra-filtered, distilled water washed and made to a volume of 45 ml. 50 KR: substances of a molecular weight 50,000 or more, ultra-filtered distilled water washed and made up to a volume of 45 ml.

assume the setting factor to be a thyroprotein. In addition to the chemical nature of the setting factor, larval settlement depends on physical properties of the substratum surface and its surface angle (turbulence near the surface). The chemical and physical factors which render a solid substratum attractive to settling bivalve larvae require further analysis. HERRMANN (1975 and personal communication) assumes that in several, if not many, marine invertebrates, the electrokinetical gradient between bacterial film and setting larvae represents an essential, setting- and metamorphosis-inducing agent.

Rearing of Spat

The term 'spat' refers to early ontogenetic bivalve stages, beginning with settlement and ending when juvenile individuals have reached a size varying from several millimetres to 1 or 2 cm; for oyster fishermen, the spat period ends with the onset of the growth period in the second summer. Bivalve spat are usually quite transparent and hence, have often been used for demonstrating and studying feeding activities, gill functions and heartbeat frequencies.

For *in situ* spat collection, collector type and collector placement (timing, locality) are essential. Suitable collector types are chosen on the basis of experiments; regular plankton sampling and careful sample analysis provide the key to timing and localization. During setting, bivalve larvae usually exhibit little tendency to 'space themselves out' (WALNE, 1974, p. 100). Hence, setting densities must be controlled by the cultivator, e.g. by removing the surplus, or by adjusting the exposure periods.

Following experimental settlement, the spat collectors are removed from the culture enclosure and placed in tanks filled with sea water which had been strained through a 68- μ m plastic mesh. Food algae are added so as to obtain a final density of 2.5 cells μ l⁻¹ of *Tetraselmis suecica* or 25 cells μ l⁻¹ of *Isochrysis galbana*. According to WALNE and SPENCER (1971a), it is vital to maintain sufficient water movement in the vicinity of the spat in order to avoid local food depletion; in addition, water movement stimulates food filtration. In a series of tests, the average filtration rate of *Ostrea edulis*, *Crassostrea gigas*, *Mytilus edulis* and related forms increased by about 50% when the water flow through the culture container was increased from 50 to 100 ml min⁻¹, and by another 50% when it was increased from 100 to 200 ml min⁻¹. For more details on bivalve food filtration consult WINTER (1969, 1970, 1973).

Cultchless, that is, free spat can be obtained by inducing oyster larvae to set on soft or pliable substrata from which they can be easily removed (e.g. sheets of plastic) or on very small particles of calcium carbonate. DUPUY and RIVKIN (1972) obtained free spat of *Crassostrea virginica* (i) 2 hrs after the larvae had set by applying small underwater jets every 2 hrs in the setting trays, (ii) ca 3 or 4 weeks after setting by shaking the setting substratum (Mylar sheets) in a barrel of water. Since spat detachment may occasionally result in injuries, cultchless spat may have to be kept in nylon-mesh protected containers for several weeks in order to protect them during shell regeneration.

Cultchless spat can be reared at higher population densities than spat set on shell cultch of oysters or scallops. Free spat can also be handled and transported more easily and yield more regular-shaped oysters than their attached counterparts.

Reattachment of cultchless spat is no problem. RILEY and co-authors (1972) reattached free spat of *Ostrea edulis* to asbestos-cement boards. After 4 months, the spat had established a firm hold on the boards and grew faster than nearby tray-grown free spat.

As with larvae, bivalve spat can be sustained satisfactorily only on unicellular algae. The food values of various algae to spat of *Ostrea edulis* are listed in Table 5-84. Mixed foods sustain growth of oyster spat better than single-alga foods. After 3 to 6 weeks, the spat attained a size of several millimetres. After this stage,

Table 5-84

Ostrea edulis. Food value of various unicellular algae to spat. The indices listed have been calculated by dividing, for each experimental series, the largest mean size attained by the mean size of the control group (grown on *Isochrysis galbana*) after 21 days (After WALNE, 1974; reproduced by permission of Fishing News (Books) Ltd.)

Species	Index of food value	
	Individual experiments	Average
<i>Monochrysis lutheri</i>	1.70, 1.03	1.36
<i>Chaetoceros calcitrans</i>	1.28	1.28
<i>Tetraselmis suecica</i>	1.42, 1.06, 1.12	1.20
<i>Skeletonema costatum</i>	0.93, 1.09	1.01
<i>Isochrysis galbana</i>	—	1.00
<i>Dicrateria inornata</i>	0.85, 1.04	0.94
<i>Cryptomonas</i> sp.	0.54, 0.74	0.64
<i>Cricosphaera carterae</i>	0.41, 0.83, 0.61	0.62
<i>Chlorella stigmatophora</i>	0.65, 0.56	0.60
<i>Phaeodactylum tricornutum</i>	0.62, 0.43, 0.73	0.59
<i>Olisthodiscus</i> sp.	0.47, 0.71	0.56
<i>Nannochloris atomus</i>	0.60, 0.60, 0.41	0.54
<i>Chlorella autotrophica</i>	0.37, 0.66	0.52
<i>Pavlova gyrams</i>	0.69, 0.32	0.50
<i>Micromonas minutus</i>	0.50, 0.40, 0.42	0.44
<i>Dunaliella euchlora</i>	0.40	0.40
<i>Dunaliella tertiolecta</i>	0.36, 0.42	0.39
<i>Chlamydomonas coccoides</i>	0.26, 0.33	0.30

they require large amounts of food, and hence, are best transferred to outdoor tanks supplied with fresh, running sea water.

Food-concentration effects on growth rates of *Ostrea edulis* spat, fed on *Isochrysis galbana* or *Dunaliella* sp., are illustrated in Fig. 5-91. The larger the cell volume of the food algae, the lower is the optimum cell concentration for spat growth (Fig. 5-92). The food concentration which sustains maximum growth rates varies with the algal species used. For best results, the optimum concentration must be determined for each population of bivalve spat and food algae.

Direct sunlight is harmful, not only to larvae, but also to spat of many bivalve species. In all developmental stages, most bivalves respond sensitively to changes in illumination. Rapid and excessive temperature changes have been held responsible

for losses, especially near the surface in floating cultures. Salinity changes often attain critical levels in estuary cultures. Water movement is essential for proper metabolic exchange and for high efficiency of food uptake. However, extreme wave action caused by heavy winds may damage the structures which support *in situ* cultures (p. 928).

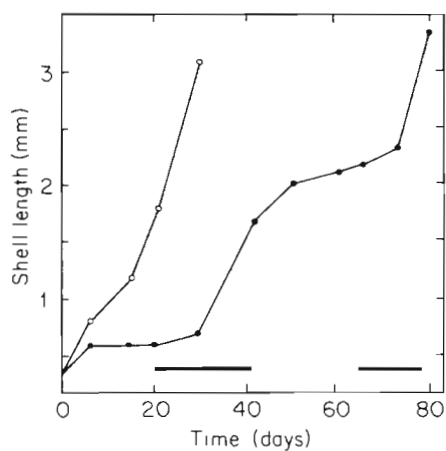

Fig. 5-91: *Ostrea edulis*. Growth rate of spat offered *Isochrysis galbana* (○) or *Dunaliella* sp. (●) as food. The *Dunaliella*-fed cultures received *I. galbana* during the two periods indicated by horizontal bars. 24° and 25° C. (After WALNE, 1974; reproduced by permission of Fishing News (Books) Ltd.)

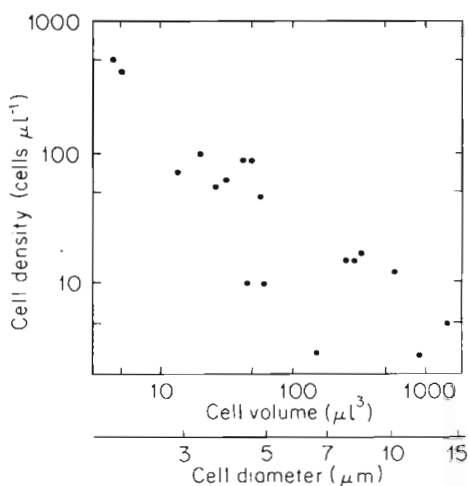

Fig. 5-92: *Ostrea edulis*. Relationship between cell volume (or diameter) and the cell concentration most favourable for spat growth. 24° to 25° C. (After WALNE, 1970b; reproduced by permission of the Controller of H.M. Stationery Office.)

Rearing of Juveniles and Adults

Adult bivalves have been reared, in most cases, under *in situ* conditions. This is especially true for commercially used species. Both under *in situ* conditions and in the laboratory, rearing of adult bivalves requires less effort, skill and technology than the rearing of larvae or spat. In general, the food algae which support growth in larvae also support growth of adults (e.g. UKELES, 1971). *Ostrea edulis*, conditioned for spawning, produced more larvae when fed a food supplement of cultured *Tetraselmis suecica* than when receiving only natural phytoplankton (HELM and co-authors, 1973). *Mytilus* species are gregarious. Attached to solid substrata by their byssus threads, they usually attain sexual maturity in about 1 year. Fertilization is external and the planktonic larvae settle after 1 or 2 weeks, depending on light, temperature, nutrition, water movement and availability of suitable substrata. In the laboratory, *M. edulis* has been cultivated under conditions comparable to those described for various oysters and used for experiments (e.g. on environmental tolerance, metabolic activity, non-genetic adaptation, food uptake and food conversion). Thermal and nutritive stresses encountered under culture conditions

may cause a general decline in body condition of *M. edulis* (BAYNE and THOMPSON, 1970). Carbohydrate and protein losses from the body parallel the degree of stress. Filtration rates and feeding activities of *M. edulis* have received attention, for example, by WINTER and LANGTON (in press), WINTER (in press) and MURKEN (in press). POIRIER (1974) studied reproductive periods, growth and related processes in cultivated *M. edulis*.

As has been pointed out before, the usefulness of cultivation for analyzing normal organism–environment relations under *in situ* conditions remains questionable as long as reasonable parallelism in performance between laboratory and field populations cannot be assured. Important criteria for assuring such parallelism are rates of food uptake, food conversion, and growth and reproduction. In addition, a variety of activities (water exchange, movements of shell and/or siphons, burrowing) can also be used as criteria. Commercial aspects of *Mytilus* cultivation have received attention in BARDACH and co-authors (1972).

Maintenance of a Breeding Stock

During the summer, eggs and larvae of bivalves can be obtained readily by collecting brooding females in the field and by transferring them to a laboratory tank. About 10 ripe oysters should be accommodated in a 30- to 50-l tank. The water in the tank (running or daily-changed sea water) should be aerated and kept at a suitable temperature (see below). Brooded larvae will be released under such conditions within a few days.

During seasons in which brooding females cannot be collected in the field, a breeding stock must be maintained. Since there exist differences in the readiness with which members of different populations spawn, and in the quality of the larvae obtained, WALNE (1974) suggests using oysters as breeding stock which have been collected from a variety of localities. However, the use of foreign material may introduce disease agents new to the area. Consequently, the effluent culture water must be sterilized. Several countries prohibit translocation of animals unless specific permission is obtained. Such control is desirable for a number of reasons and should be supported by ecologists (for details consult Volume V).

For maintaining a breeding stock of *Ostrea edulis*, WALNE (1974) used 50-l tanks with 10 *Ostrea edulis* each. The tanks received running, raw sea water (23° C) at the rate of 15 to 20 l hr⁻¹ (open sea-water system). The sea water was enriched with suspensions of food algae (cultured *Isochrysis galbana* and *Tetraselmis suecica*). Alternatively, the oysters were kept under comparable conditions in a closed sea-water system. In this case, a mixture of food algae was automatically added to the culture tank to give a continuous, adequate level of cell density in the culture water.

Gamete Maturation

Gamete maturation can be enhanced independently of the season by suitable temperature treatment (e.g. LOOSANOFF and DAVIS, 1950, 1952, 1963a). *Crassostrea virginica*, for example, were collected in the habitat at near-freezing temperatures, exposed to water of somewhat higher temperature and then subjected to gradual (a few degrees centigrade day⁻¹) temperature increase. At 25° C, spermatozoa and

eggs of *C. virginica* matured 5 days after the oysters were caught in ice-covered water; at 30° C, in 3 days. Sometimes—especially towards spring—*C. virginica* can be placed directly in water of about 20° C without apparent loss in gamete vitality. In this way, the length of the conditioning period may be shortened by several days. For oysters kept at 20° C, the conditioning period is about 3 to 4 weeks. Comparable conditioning has been reported for other bivalves. In general, slow temperature increase yields more reliable results than shock treatment.

Conditioning is possible only after the oysters have recovered from their natural spawning activities of the preceding summer (LOOSANOFF, 1937a, 1942). Mature adults can be prevented from spawning by low temperatures, e.g. below 18° C. By combining thermal conditioning and thermal prevention of spawning, ripe bivalves can be made available for spawning throughout the year. Provided the thermal patterns employed by the cultivator allow the bivalves to recover rapidly from spawning, *Crassostrea virginica* and *Mercenaria mercenaria* are able to reproduce several times per year (LOOSANOFF and DAVIS, 1963a). Methods identical or similar to those employed by LOOSANOFF and DAVIS have been used successfully in a variety of bivalves, e.g. in *Pecten maximus* (GRUFFYDD and BEAUMONT, 1970).

Gamete Release

Mature bivalves may be stimulated to release their gametes by a variety of stimuli—biological, thermal, osmotic, electrical, mechanical, chemical or radiant (Table 5-85). However, not all bivalves are equally responsive to a certain stimulus, and different populations of the same species may exhibit notable differences. Hence, combinations of stimuli have been tried. The bivalves to be treated have usually been placed in glass dishes containing 1 or 2 l of sea water of the same temperature and salinity to which they were acclimated. In the majority of cases, the stimulation methods employed thus far have been quite successful, but have failed to produce consistent results, even in the same species (see also pp. 897 and 960).

Biological stimulation is effected by adding small amounts of sperm or egg suspension, prepared from the gonads of ripe conspecifics (e.g. GALTISOFF, 1938; LOOSANOFF and DAVIS, 1963a). In some species, substances released into the water by other organisms (e.g. unicellular algae, zooplankters) also seem to induce spawning. In *Ostrea gigas*, for example, green algae such as *Enteromorpha linza*, *Monostroma* sp. or *Ulva pertusa*, provoked spawning of males (MIYAZAKI, 1938); 1 mg of wet *U. pertusa* contains a sufficient amount of the stimulating substance to initiate spawning. The active principle is sea-water soluble and boiling resistant. Where biological stimuli have proved insufficient, they have been supported, or substituted for, by other stimuli.

Thermal stimulation (i.e. slow changes in temperature or shock treatment) has been employed with considerable success in a number of species, especially oysters (e.g. GALTISOFF, 1930, 1932, 1940; LOOSANOFF, 1937a, 1954). In most cases, temperature increase (e.g. 1 C° hr⁻¹ or 1 C° day⁻¹) to a certain level (e.g. 20° or 30° C) has been used. The new high temperature level was then maintained for days or weeks.

Osmotic stimulation through changes in salinity or temporary exposure to air has been suggested or demonstrated in a few cases. In *Pecten maximus*, for example,

exposure to air for about 2 hrs has stimulated gamete release within 2 to 4 hrs after re-immersion (GRUFFYDD and BEAUMONT, 1970).

Electrical stimuli (mild electrical shocks) have been introduced by Japanese cultivators. IWATA (1949b) applied 20 V for 5 secs to ripe *Mytilus edulis*; after 1 hr, all mussels began to spawn. Consistent results have not yet been obtained.

Table 5-85

Stimulation of gamete release in bivalves (Compiled from the sources indicated)

Species	Stimulus	Author
<i>Anodara broughtonii</i>	Thermal	IMAI and NISHIKAWA (1969)
<i>Arca transversa</i>	Thermal	LOOSANOFF and DAVIS (1963a)
<i>Ensis directus</i>	Thermal	LOOSANOFF and DAVIS (1963a)
<i>Laevicardium mortoni</i>	Thermal	LOOSANOFF and DAVIS (1963a)
<i>Lithophaga bisulcata</i>	Radiant, photoperiod (?)	CULLINEY (1971)
<i>Mactra solidissima</i>	Thermal	LOOSANOFF and DAVIS (1963a)
<i>M. sulcataria</i>	Chemical	IWATA (1948), SAGARA (1958a)
<i>M. veneriformis</i>	Chemical	IWATA (1948), SAGARA (1958a)
<i>Mercenaria campechiensis</i>	Biological, thermal	LOOSANOFF and DAVIS (1963a)
<i>M. mercenaria</i>	Biological, thermal	LOOSANOFF and DAVIS (1963a)
<i>Meretrix lusoria</i>	Chemical	IWATA (1948), SAGARA (1958a)
<i>Mya arenaria</i>	Biological, thermal	LOOSANOFF and DAVIS (1963a)
<i>Mytilus edulis</i>	Thermal, chemical Electrical Mechanical	IWATA (1949a, 1951a-d, 1952a, b), SAGARA (1958a), LOOSANOFF and DAVIS (1963a) IWATA (1949b) FIELD (1922), LOOSANOFF and DAVIS (1963a)
<i>Ostrea edulis</i>	Biological, thermal	LOOSANOFF and DAVIS (1963a)
<i>O. gigas</i>	Biological	MIYAZAKI (1938)
<i>O. lurida</i>	Thermal	LOOSANOFF and DAVIS (1963a)
<i>O. virginica</i>	Biological, thermal, chemical	NELSON (1928), GALTSOFF (1932, 1938, 1940), LOOSANOFF and DAVIS (1963a)
<i>Pecten irradians</i>	Thermal	LOOSANOFF and DAVIS (1963a)
<i>P. maximus</i>	Osmotic (air exposure)	GRUFFYDD and BEAUMONT (1970)
<i>P. yessoensis</i>	Thermal Chemical	IMAI (1967) KINOSHITA and co-authors (1943)
<i>Patricula pholadiformis</i>	Thermal	LOOSANOFF and DAVIS (1963a)
<i>Pinctada margaritifera</i>	Chemical	SETOGUCHI (1959)
<i>P. mantoussi</i>	Chemical	WADA (1947), KOBAYASHI and YUKI (1952)
<i>P. maxima</i>	Chemical	WADA (1942)
<i>Pteria macroptera</i>	Chemical	SETOGUCHI (1957, 1958)
<i>Tapes japonica</i>	Biological, thermal Chemical	LOOSANOFF and DAVIS (1963a) IWATA (1948), SAGARA (1958a)

Mechanical stimuli (handling, shaking in a dish of sea water, adductor-muscle pricking, exposure to air) have been employed by a number of investigators. Rough handling and shaking of *Mytilus edulis* induced spawning within 1 hr (FIELD, 1922). Adductor-muscle stimulation (cutting, stretching, pricking) in *M. edulis* led to spawning within 12 to 48 hrs (LOOSANOFF and DAVIS, 1963a). The eggs were released in 'strings', as during normal spawning, and the number of structurally abnormal

larvae did not deviate from that obtained in individuals with unusually relaxed or stretched adductor muscles or after inserting a small wooden wedge between the mussel's shells. Apparently, the adductor-muscle nerve is the responsive agent. Of 60 nerve-stimulated *M. edulis*, 54 responded, but none of the 60 control mussels spawned. All stimulated individuals remained alive for at least two weeks, after which they were discarded. LOOSANOFF and DAVIS filed a small notch at the shell's edge, through which the sharp needle used for pricking could be inserted whenever spawning was desired.

Chemical stimuli have been explored especially in Japan (IWATA, 1948, 1949a, 1951a, b, c, 1952a, b; SAGARA, 1958a, b). A strip of *Mytilus edulis* mantle tissue released gametes at its cut ends after 5-min washing in a 0.5 M KCl solution (IWATA, 1949a, b, 1951a). The gamete release began 1 hr after the treatment; it started much sooner at high pH values (NaOH addition) and was inhibited in pH values below 7 (HCl addition). Bathing mantle pieces of *M. edulis* in 0.5 M solutions of NH_4Cl , or BaCl_2 also induced gamete release (IWATA, 1951c, 1952a). SAGARA (1958a) obtained discharge of sexual products after bathing pieces of *M. edulis* mantle in ammoniated sea water. BREESE and PHIBBS (1969) induced spawning in ripe *Saxidomus giganteus* by adding 1 or 2 g of KCl to 1 l of sea water. In *Macra sulcataria* and *M. veneriformis*, increase in NH_4^+ and pH (alkalinity) induced spawning (SAGARA, 1958a); apparently, NH_4^+ was particularly effective. Immersed in a suitable concentration of ammoniated sea water, ripe *Corbicula japonica*, *Crassostrea gigas*, *Macra sulcataria*, *M. veneriformis* and *Trapezium japonicum* released their gametes in the absence of thermal stimulation.

In several bivalves, injections of chemicals (usually isosmotic solutions) have produced prompt results (IWATA, 1948; SAGARA, 1958a). From the ova and spermatozoa released, fertilized eggs were obtained which developed normally to swimming larvae. All *Macra sulcataria* which were injected 2 ml of a neutral potassium-salt solution spawned shortly afterwards, and *M. veneriformis* spawned within a few minutes after injection of a potassium chloride solution into its visceral cavity (IWATA, 1948). KNO_3 , K_2SO_4 , and other neutral potassium salts were also quite effective, but MgCl_2 , MgSO_4 and CaCl_2 less so.

Ultra-violet radiation, quite effective in gastropods (p. 900), seems to work also for bivalves. In *Lithophaga bisulcata*, which did not respond to other stimuli, CULLINEY (1971) has proposed that changes in the photoperiod might govern spawning activity. Changes in pH (see above) and other environmental entities may induce spawning of individuals with ripe gonads. In ripe *Anadara subcrenata*, *Brachidontes senhousia*, *Haliotis discus*, *H. sieboldii* and *Pecten yessoensis*, gametes were released upon simultaneous increase in temperature and alkalinity (SAGARA, 1958a).

In summary, the most effective stimuli appear to be biological, thermal and osmotic. Only fully mature individuals are likely to respond, and only ripe gametes are likely to yield viable offspring. Naturally spawned bivalve eggs are in the process of maturation division and sperm are activated immediately after exposure to sea water. In individuals ready to spawn, gamete release may be initiated by a variety of changes in environmental conditions; in most cases, these changes seem to involve a degree of stress or shock acting through a common denominator (e.g. certain changes in physiological state). Some investigators have speculated that

pH changes in the gonad tissue may act as releaser. Further research is required to elucidate the exact nature of the releasing agent.

Where less dramatic treatment fails, stripping may be applied for obtaining ripe gametes. LOOSANOFF and DAVIS (1963a) recommend the following procedure for stripping ripe females of *Crassostrea virginica*: (i) Remove the outer membrane that covers the gonads, and rinse the bivalve gently in sea water; such rinsing separates large numbers of eggs from the gonads without seriously injuring them. (ii) Clean the eggs, place them in sea water and add spermatozoa. (iii) Transfer the fertilized eggs to clean culture dishes containing filtered (sterilized) sea water. This procedure is successful only in species whose germinal vesicles dissolve after stripping. In others, e.g. *Mercenaria mercenaria* or *Pitar murrhiana*, the germinal vesicles remain intact and prohibit fertilization. The germinal vesicles of these species normally dissolve, while the eggs are still in the female's ovary, just before they are spawned (LOOSANOFF, 1954).

Table 5-86

Mercenaria mercenaria. Percentage of normally developing stripped eggs treated with ammonium hydroxide (3 ml of 0.1 normal solution per 100 ml of egg suspension) as a function of treatment time (Based on data by LOOSANOFF and DAVIS, 1963a)

Exposure period (mins)	Normally developing eggs (%)
15	32
30	16
45	9
60	3
75	2
90	0

Stripped eggs with germinal vesicles resistant to dissolution can be rendered fertilizable by exposure to a weak solution of ammonium hydroxide (add 3 ml of 0.1 normal solution to 100 ml of egg suspension). Table 5-86 gives the percentage of normally developing eggs of *Mercenaria mercenaria* obtained after different periods of exposure to ammonium hydroxide.

In Situ Cultures

The principles of bivalve *in situ* cultivation are exemplified here by referring to oysters. In oysters, bottom cultures and off-bottom cultures can be distinguished.

Bottom cultures

Bottom cultures are accommodated directly on the ground. In general, they are less productive than off-bottom cultures. Hence, bottom cultures have been discontinued in many countries.

Bottom cultures require suitable beds with a clean ground (1 to 10 m below the water surface) and sufficiently strong tidal currents. The most important disadvantages of bottom cultures are the dangers of excessive silt sedimentation and easy access of predators. Newly planted seed oysters often suffer high losses from siltation and predation. In the large intertidal areas of Brittany (France), bottom cultures are easily accessible during spring low tide, and can be attended and managed almost as readily as a house garden.

The management efforts in bottom cultures comprise three essentials: avoidance of excessive siltation, control of predation and thinning, i.e. transfer of oysters to new beds as individual growth causes crowding. Excessive silt is removed by suction (airlift, pumps) or by pressure (water jets). Predation control involves mechanical, chemical or biological methods (p. 932; see also p. 1152).

Off-bottom cultures

Off-bottom (suspension) cultures are accommodated on ground-rooted frames or anchored floats. Pioneered by the ancient Romans (see GÜNTHER, 1895), off-bottom cultures are now used in many countries. Their advantages are (i) high production potential, (ii) easy accessibility, (iii) low silt sedimentation, (iv) reduced availability to predators, (v) good crowding control. The major disadvantage is the cost of constructions and repair. Depending on the type of support structures used, four basic methods of off-bottom cultivation can be distinguished: rack, raft, long-line and tray methods.

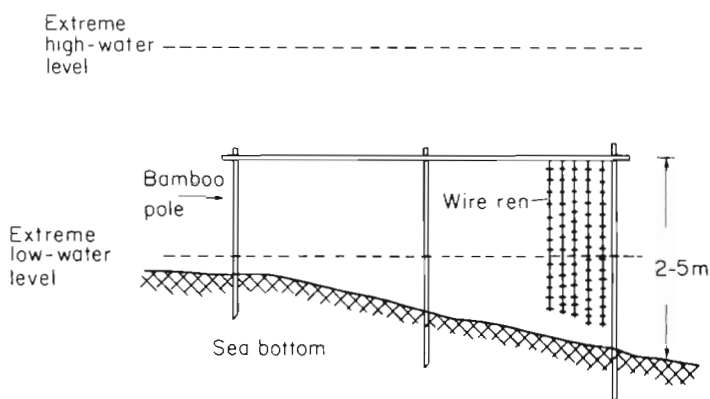

Fig. 5-93: Rack method for *in situ* oyster cultivation. Vertical poles are driven into the ground and connected by horizontal poles from which the rens (ropes or wires) are hung. (After FUJITA, 1970; modified; reproduced by permission of Biologische Anstalt Helgoland.)

The rack method (Fig. 5-93) requires shallow water. Vertical poles are driven into the ground and, at their top, connected by evenly spaced horizontal poles; these hold the rens (ropes or wires), which support the shells or related material serving as substratum for the oysters. The length of the rens depends on water depth; no rens should touch the sea bottom. Originally, the rack method has been employed in Japan especially for oyster fattening, but now it is mostly used for growing seed

oysters and for hardening young oysters (FUJIYA, 1970). A modification of the rack method is the stick method which involves a creosoted wooden stick (2.5 cm in diameter, 46 cm long) with a 5-cm nail driven part way into the upper end. The stick is pushed into the bottom nearly 30 cm, and a single oyster shell is placed on the nail through a hole in the shell (QUAYLE, 1969). The sticks are placed about 30 cm apart with lanes every metre to allow planting and harvesting. Seed of any size may be used and about 10 oysters may be grown to market size on a single stick. The method works well on very soft ground.

Rafts (Fig. 5-94) have often been standardized in terms of support dimensions and construction. In Japan, a standard raft measures 16 × 8 m and carries 500 to 600 wire rens. The rafts are made from 10- to 15-cm diameter poles (bamboo or cedar) which are lashed with wire and arranged in two layers, at right angles to each other, and with the poles 30 to 60 cm apart. Rafts are buoyed by hollow concrete drums, tarred wooden floats or styrofoam cylinders. Encased in a polyethylene bag

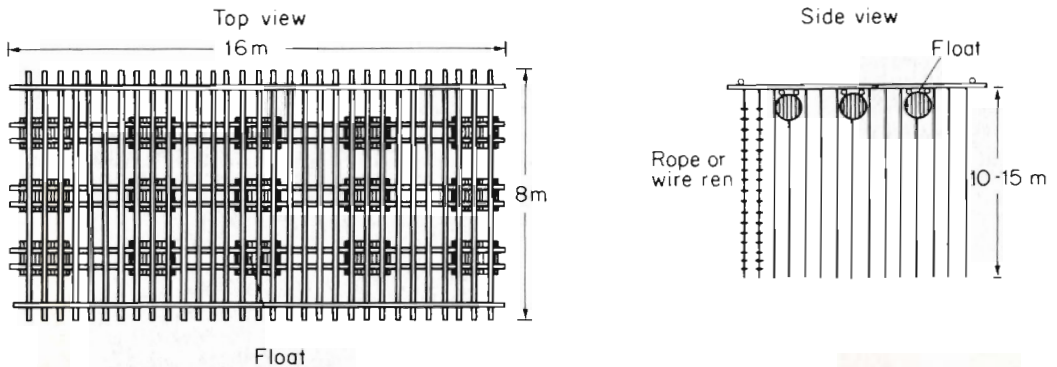

Fig. 5-94: Raft method for *in situ* oyster cultivation. (After FUJIYA, 1970; modified; reproduced by permission of Biologische Anstalt Helgoland.)

for protection, styrofoam cylinders have increasingly replaced the other float types and are now used in all newly constructed rafts (FUJIYA, 1970). As the oysters grow and their weight increases, additional floats are added as required. Rafts are commonly laid out in rows, 5 to 10 m apart, tied together and anchored at each end.

Recent experiments with oysters suspended from rafts have been conducted, for example, by QUAYLE (1971), BAE (1973), GIBSON and LUND (1973) and WELLER and CHEW (1973). MEIXNER (1971, 1973) suspended the Japanese oyster *Crassostrea gigas* from floats in the 'Flensburger Förde' (Baltic Sea) and near the island of Sylt (North Sea). In order to protect the oysters from ice damage in winter, they were lowered near the sea bottom when temperatures approached the freezing point. Preliminary results on growth and survival indicated that the Japanese oyster seems to grow well under Baltic-Sea and North-Sea conditions (WALNE and SPENCER, 1971b; MEIXNER, 1972).

The long-line method (Figs 5-95, 5-96) has been developed in northern Japan and was first applied in 1947 (FUJIYA, 1970). Long lines are particularly useful in stormy areas, and have allowed extension of oyster cultivation to the open sea. The long-line method employs series of rope-connected floats. Each series is 70 to 75 m long

and fastened at each end to 2 or 3 anchors. In rough waters, the middle portion of the floats is also anchored.

Floating trays have been used, for example, in the USA. The floating-tray method was judged 'biologically effective, but economically unfeasible' (BARDACH and co-authors, 1972, p. 697). However, PARSONS (1974) feels that tray cultivation may be economical, especially in areas without existing oyster fisheries. According to SCHOLZ (1973), seed oysters (*Crassostrea gigas*), held in trays for 4 months prior to planting, exhibit twice the survival of seed oysters planted directly on the ground, but growth rates were the same in both cases. In North American oyster farms,

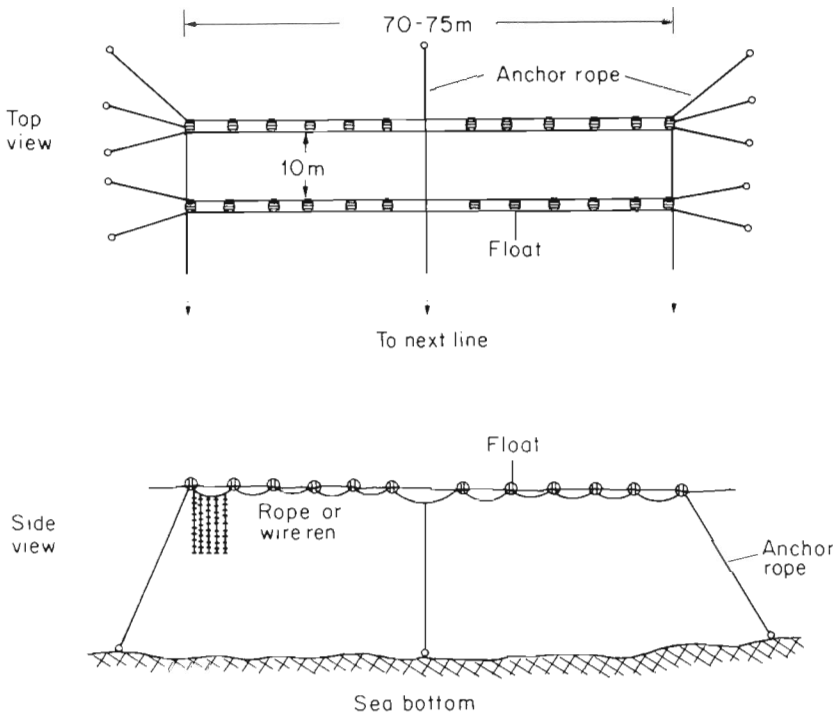

Fig. 5-95: Long-line method for *in situ* oyster cultivation. Wire rens are shown only for one float interval. (After FUJIYA, 1970; modified; reproduced by permission of Biologische Anstalt Helgoland.)

various types of suspension methods are presently being tested with the aim of developing biologically, economically and legally feasible techniques.

The average yield of different *in situ* oyster-culture methods is listed in Table 5-87. This table indicates that off-bottom cultures produce a better yield than bottom cultures (BARDACH and co-authors, 1972).

Predators, Competitors, Parasites and Poison Producers

The major predators of adult bivalves are sea stars (e.g. *Asterias vulgaris*, *A. forbesi*) and drills (e.g. *Ceratostoma burnetti*, *Eupleura caudata*, *Rapana thomasiana*, *Urosalpinx cinerea*, *Thais bronni*, *T. tumulosa clavigera*, *Tritonalia japonica*). In

addition, a variety of gastropods, crustaceans, annelids and fishes act as bivalve predators (e.g. QUAYLE, 1969). Mortalities in *Crassostrea virginica* beds due to predation, siltation and overgrowth have received attention from MACKENZIE (1970a).

Mechanical predation control comprises predator collection by divers, suction dredges, sea-star mop or underwater ploughing. The sea-star mop is constructed of a 3-m iron beam, to which numerous chains are attached, each of which carries a bundle of 2-m-long rope yarn. Small ships drag one or two mops slowly over the oyster beds and, at intervals, lift them—together with the entangled sea stars—aboard, where the latter are killed by immersing the rope yarn in hot water. Preceding planting, ploughing is applicable only in sediment-covered bottom areas. It buries and kills many of the predators.

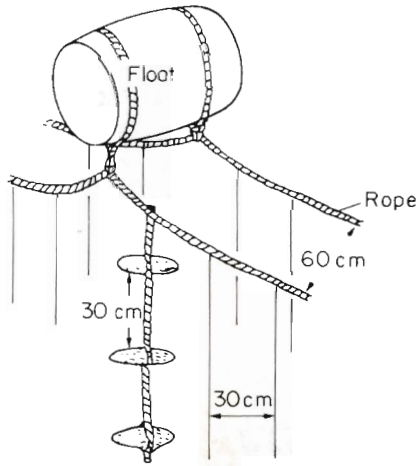

Fig. 5-96: Long-line method. Detail of float and rope arrangement. Only one of the hanging ropes is shown in full; the others appear as vertical lines. (After FUJIYA, 1970; reproduced by permission of Biologische Anstalt Helgoland.)

Chemical methods of predation control employ such substances as quicklime, salt or biocides. Upon contact, quicklime applied to oyster beds (ca 300 to 400 kg ha⁻¹) causes disintegration of sea-star tissue within 24 hrs. For maximum efficiency, fine particulate lime is pumped directly onto the oyster bed. The advantage of quicklime lies in its reliability and the relative ease of application; disadvantages are its high cost and potential damage to other marine organisms. Salts (saturated rock-salt solution) are cheap and effective. However, the oysters must be collected (dredged) and dipped into the salt solution. They are then exposed to air (from several minutes to 1 hr) before returning them to the culture bed. Such handling is expensive. Biocides, e.g. chlorinated hydrocarbons and related pesticides, are often applied in considerable quantities (e.g. 1000 to 2500 kg ha⁻¹) on previously cleaned bottom areas before planting the seed oysters.

According to MACKENZIE (1970b), American oyster companies use a standard rate to 190 l of Polystream* per acre of oyster bed. MACKENZIE made 5 experimental and 10 commercial Polystream applications, and reports: (i) Immediately after treatment, oysters, clams and other marine organisms accumulate small residues of Polystream in their tissues. These residues are gradually lost within 119 days. (ii) If transplanted from a treated to an untreated bed, the bivalves lose the residues

Table 5-87

In situ methods for growing oysters. Average annual yields (meat weight excluding shells) obtained in five different countries (After BARDACH and co-authors, 1972; modified; reproduced by permission of Wiley, New York)

Species	Method	Yield (kg ha ⁻¹ year ⁻¹)	Country
<i>Crassostrea angulata</i>	Bottom culture in pares	1,000	France
<i>Crassostrea commercialis</i>	Tray method (best areas)	5,400	Australia
<i>Crassostrea commercialis</i>	Rack method (best areas)	2,000	Australia
<i>Crassostrea gigas</i>	Long-line method	26,000	Japan
<i>Crassostrea gigas</i>	Raft method	20,000	Japan (south)
<i>Crassostrea gigas</i>	Raft method	1,000	Japan (north)
<i>Crassostrea rhizophorae</i>	Experimental raft method	6,600	Cuba
<i>Crassostrea virginica</i>	Bottom culture, with intensive management	5,000*	United States (Atlantic coast)
<i>Crassostrea virginica</i>	Public grounds—little or no management	10–100	United States (Atlantic coast)
<i>Ostrea edulis</i>	Bottom method in pares	250	France

* Projected yield using new methods.

within a week. (iii) At lower water-current velocities, all oyster drills were killed as were significant numbers of clams and other invertebrates as well as fishes. (iv) Oyster growth appeared normal in treated beds. It is well known, however, that chlorinated hydrocarbons and related chemical substances constitute a deadly threat to marine life. The use of such substances must be controlled very carefully; wherever possible, they should be banned from the marine environment (Volume V).

* Trademark of Hooker Chemical Corporation (USA) for a mixture of polychlorinated benzenes containing a minimum of 95% total of active trichlorobenzene, tetrachlorobenzene and pentachlorobenzene, and having a last crystal point of 18° C.

Biological methods of predator control, i.e. the reduction in predator numbers or predator activities by introducing or by supporting organisms which combat the predators, are still in their exploratory phase. Different environmental tolerances between predators and prey provide an important key to predator control.

Competitors, e.g. animals with identical or similar feeding habits or substrate preferences, are, for example, sponges, barnacles, other bivalves and tunicates. Parasites, such as *Polydora* spp. (mostly *P. ciliata*), are common in Japanese oyster farms (FUJIIYA, 1970); sometimes 60 to 70% of the oysters are infested by *P. ciliata*, but apparently, damage is not very serious (SATO, 1967).

Poison producers, e.g. red-tide organisms such as diatoms, dinoflagellates and ciliates, are common in many waters used for oyster farming. According to SATO (1967), most red-tide organisms do little or no damage to oysters, but *Gymnodinium* spp. can cause heavy losses. In raft cultures, such damage can be minimized by towing the raft into an area free of the pest before severe damage occurs. *Gymnodinium* species are said to exert critical effects when their concentration increases above 2000 or 3000 cells ml⁻¹. Shellfish poisoning, which has paralyzed or killed a number of people, occurs mainly in summer (frequent causative agents: *Gonyaulax catenella* or *G. acatenella*). Most bivalves examined lost their toxicity within a few weeks after the red-tide blooms disappeared.

(c) Mollusca as Assay and Food Organisms

Although successful culture methods are available for several molluscs, especially oysters, the potential of these forms as assay and food organisms has remained largely unexplored. A few representatives have been used for toxicity tests and as experimental material for assessing biological consequences of pollutants, such as heavy metals, detergents and insecticides (Volume V). In *Crassostrea* species, for example, CUNNINGHAM and TRIPP (1973, 1975a, b) studied mercury accumulation, and BRERETON and co-authors (1973), CALABRESE and co-authors (1973) as well as BOYDEN and co-authors (1975) investigated zinc toxicity. The inhibition of embryonic development of *Mercenaria mercenaria* by heavy metals has been studied by CALABRESE and NELSON (1974), and WOELKE (1966) used bivalve larvae for bioassay purposes. FOWLER and BENAYOUN (1976) analyzed the selenium flux in *Mytilus edulis*.

Members of several mollusc species (e.g. *Mya arenaria*, *Mytilus edulis*, *Cardium edule*, *Crassostrea virginica*) have been fed to other cultivated animals—either in the form of tissue pieces or as larvae.

Gastropods, bivalves and other molluscs deserve much more attention in regard to the role they may play as assay and food organisms. Especially the larvae, which can be easily produced in large numbers, qualify as suitable test material and as food source for plankton feeders.

(d) Mollusca: Conclusions

Although molluscs, especially gastropods and bivalves, have attracted attention since prehistoric times—as food, tools and ornaments—and have served as objects for scientific inquiry for centuries, cultivation of marine molluscs has centered

largely on a few species. More than 75% of the papers devoted to mollusc cultivation deal with commercially important bivalves.

As in other marine invertebrates, the culture of larvae has challenged the mollusc cultivator more than that of juveniles or adults. Larvae tend to be less tolerant to environmental stress and to poor nutrition than later life-cycle stages.

For many gastropod and bivalve larvae cultivated thus far, similar culture techniques have been employed. The essentials of larval rearing may be summarized as follows: (i) The larvae are obtained from spawners collected in the field or kept as breeding stock in the laboratory, and reared in culture enclosures such as beakers, jars, bins or tanks. (ii) Water-quality requirements as well as optimum conditions of light, temperature, salinity, and of larval and food concentrations vary considerably; they must be adjusted to species-specific demands and continuously controlled. (iii) Unless running water is used, the culture water should be renewed regularly, e.g. every other day. (iv) Most mollusc larvae are herbivorous; some later become omnivorous or, more rarely, carnivorous. A variety of small, thin-walled phytoplankters have been shown to provide adequate food sources. Of the dried, natural food examined, only unicellular algae have yielded satisfactory results. Artificial foods were accepted in a few cases; they supported growth considerably less well than living plankters. (vi) Settling larvae must be offered a suitable substratum.

The attractiveness of a substratum to settling larvae increases after (i) substrate exposure to sea water; (ii) formation of a film of micro-organisms; (iii) settlement of mollusc spat or adults, preferably of the same species; (iv) painting the substratum surface with extracts of bivalve faeces or meat, preferably of conspecifics; (v) substrate treatment with certain chemicals. The nature of the factor(s) responsible for rendering a substratum more attractive to the larvae remain(s) to be fully explored.

In the Gastropoda, virtually all feeding types are represented. Many herbivores have a radula with numerous small teeth, a chitinous jaw, and an enlarged oesophagus (crop). Most carnivorous gastropods possess a radula with less numerous but larger teeth. In some prosobranch families, the radula is modified into a drilling organ—e.g. in the Muricidae with the genera *Eupleura*, *Murex* and *Urosalpinx* and the Naticidae with the genus *Polinices*. These drilling forms feed on bivalves. The prosobranch *Conus striatus* feeds on annelids and fishes. With modified, long radula teeth, the prey is stabbed, poisoned and immobilized. Aeolidiidae (nudibranchs) feed on cnidarians (hydroids, sea anemones). Ciliary feeding prevails in some sessile forms such as species of *Crepidula* and in *Limacina*. Members of the genus *Stylifer* live imbedded in, and feed on, the body wall of echinoderms.

While the majority of the bivalves are suspension feeders which trap small food particles with their ciliary feeding mechanisms (Volume II: PANDIAN, 1975), some use their proboscis to obtain food from bottom detritus, e.g. most protobranchs. Nutritional specialists among the Bivalvia are, for example, the giant clam *Tridacna* which 'farms' unicellular algae and uses them as a supplementary diet, and the Septibranchia which live predominantly carnivorous or as scavengers.

As in other invertebrates and in fishes, the digestive capacity of molluscs depends on the enzymes available and their activities which, in turn, are a function of environmental factors, especially temperature. While at critically low or high temperatures a certain food alga may still be taken up, it may no longer be possible to

digest it. Consequently, nutritional studies must be performed under closely defined environmental circumstances. In addition, the environmental and nutritional history of the food alga must be known, since it may modify essential characteristics of the alga concerned.

Especially in the bivalves cultivated has it been possible to condition gamete maturation and gamete release. The main stimuli include addition of sperm and/or egg suspensions to the culture water, temperature increase, ultra-violet irradiation, mild electrical shocks, rough handling, adductor-muscle stimulation, and chemical agents such as ammonia or potassium chloride. In individuals ready to spawn, different stresses (thermal, radiant, mechanical, electrical, chemical) may act through a common denominator producing a certain physiological state that initiates the spawning process. Where conditioning fails to initiate spawning, stripping of ripe adults may be employed.

Several bivalves are presently farmed with a high degree of success, and specific culture systems for oysters and clams are being developed (e.g. EPIFANIO and co-authors, 1975, in press). Long-term growth of juvenile and adult bivalves in closed sea-water systems has been studied by HARTMAN and co-authors (1973), EPIFANIO and MOOTZ (in press), EPIFANIO and co-authors (in press) and MURKEN (in press). Using a recirculating system similar to that illustrated in Fig. 2-12 (p. 47), the latter team has reared *Crassostrea virginica*, *C. gigas*, *Mercenaria mercenaria*, *Mytilus edulis*, *Ostrea edulis* and *Tapes semidecussata* under controlled dietary conditions. The diatom *Thalassiosira pseudonana* turned out to be good food. It yielded growth comparable to that of a four-component diet (*Carteria chuii*, *Crocomonas salina*, *Isochrysis galbana*, *Thalassiosira pseudonana*) when fed to *C. gigas*, *C. virginica* and *T. semidecussata*, while the four-component diet was superior with *M. edulis* and *O. edulis*. *Phaeodactylum tricornutum* proved to be poor food for all six bivalves tested. Recycling of organic wastes reduces the cost of nutrients for the phytoplankton food, as well as the danger of environmental pollution due to culture effluents. At the same time, they allow maximum control of essential culture-system functions.

In addition to the bivalves already mentioned, the following species are cultivated in Japan: *Anadara broughtonii*, *A. granosa*, *A. subcrenata*, *Atrina japonica*, *Fulvia mutica*, *Mactra sachalinensis*, *M. sulcataria*, *Meretrix lusoria*, *Platinopecten yessoensis*, *Sinovacula constricta* and *Tapes japonica*. Although less than some 3% of the mollusc species known have been kept in culture, the information at hand is considerable. With comparable or somewhat modified culture techniques it should be possible to cultivate many more forms and to make them available for biological studies and as assay and food organisms.

(12) Echinodermata

(a) General aspects

Exclusively marine and largely pentaradiate bottom dwellers, the Echinodermata comprise some 5400 known species, usually accommodated in the following

five classes: Crinoidea (sea-lilies, feather-stars), Holothuroidea (sea-cucumbers), Asteroidea (sea-stars or starfishes), Echinoidea (sea-urchins, heart-urchins, sand dollars) and Ophiuroidea (brittle-stars). Major characteristics of the echinoderms include: a water vascular system, a spacious coelome, and simple nervous and reproductive systems. The contact between most tissues and the ambient sea water is direct and immediate. Hence, most echinoderms respond sensitively and immediately to changes in water quality and exhibit quite limited tolerances to changes in salinity.

Echinoderms inhabit oceans and coastal waters of all latitudes and all water depths. In addition to such habitat plasticity, most species exhibit a high degree of nutritional versatility. Many species are nutritionally unspecialized opportunists capable of utilizing almost every food item they can get hold of. All echinoderms examined command an impressive capacity for regeneration.

With a few exceptions, the members of this common, conspicuous and morphologically well-characterized phylum are dioecious. However, the sexes are usually not distinguishable externally. In sea-stars and sea-urchins, ripe individuals can be sexed by biopsy (hypodermic-needle probing through peristome membrane into one of the gonads) or by artificial induction of gamete release, e.g. by electrical stimulation (p. 963). Most echinoderms release their ripe gametes into the surrounding water, where fertilization occurs and where the bilaterally organized planktonic larvae develop until they become more and more radially organized, metamorphose and settle down to bottom life. Several cold-water forms brood their eggs and young.

A number of Echinodermata have been cultivated, especially members of the large class (ca 2000 species) Asteroidea and of the much smaller class (ca 800 species) Echinoidea. More than 85% of the culture experiments conducted thus far are concerned with physiological, biochemical or morphological investigations, concentrating on such processes as gametogenesis, fertilization and embryonic development. There is a deplorable lack of ecological studies.

A few authors have examined the feasibility of holothurian mariculture (e.g. MOKRETSOVA, 1973; WERNER, in press) and O'CONNOR (in press) is investigating possibilities for open-sea cultures of sea-urchins. The high prices paid for sea-urchin roe and the relatively low investments required may render sea-urchin *in situ* cultivation commercially attractive. However, in general, the Echinodermata are of little economic importance. Asteroids prey on oysters and clams (p. 931), including commercially important species, and echinoids may cause high losses to cultured marine algae (Chapter 4.2). In several countries, ripe sea-urchin gonads are eaten, either raw or cooked, and, in the Orient, the sun-dried body walls of large holothurians (e.g. species of *Holothuria*, *Stichonus*, *Thelenotia*) are treasured as delicacies ('trepan'). The echinoderms are the only major animal phylum without parasitic representatives; commensal echinoderms are rare (ophiuroids). However, echinoderms are parasitized by members of most other invertebrate phyla (KINNE in press).

Important reviews on echinoderms which include information immediately relevant to cultivation have been presented by HYMAN (1955), NICHOLS (1962), BOOLOOTIAN (1966a), FERGUSON (1969b), HÖRSTADIUS (1973) and CZIHAK (1975). Aspects of echinoderm feeding have been reviewed in Volume II: PANDIAN (1975) and in Volume IV: CONOVER (in press).

(b) Rearing of Larvae

In most Echinodermata studied thus far, rearing of larvae is easy. After hatching, many larvae develop for a considerable period of time without food. Sea-urchins and sea-stars provide classic materials for demonstrating the processes of fertilization, embryogenesis and early larval development to students in high schools and universities. At normal temperatures, many echinoids go through the first cleavage 1 to 3 hrs after fertilization, reach the early pluteus stage after 2 to 6 days, and metamorphose after 20 to 50 days. The late plutei require food (p. 942) in order to continue their development. Larval types of echinoderms are illustrated in Fig. 5-97.

Fertilization, Incubation and Hatching

Sea-urchins and sea-stars are model objects for the study of gametogenesis, fertilization and embryogenesis. Many principal features of the fertilization process (i.e. the union of spermatozoon and ovum, subsequent fusion of both pronuclei, and activation of egg development) and of invertebrate embryogenesis have been explored in echinoids and asteroids. Of the pioneers who introduced echinoderm gametes as experimental material and who laid the foundations of modern investigations in the fields of fertilization and embryogenesis, the following deserve special mention: DERBÈS (1847), HERTWIG (1876, 1877, 1878) FOL (1877, 1879), HERTWIG and HERTWIG (1887), and BOVERI (1889, 1901a, b, 1902, 1908). The discoveries made by these early investigators and by their successors have been summarized and discussed in the light of later findings in reviews by LILLIE (1919), TYLER (1948), HYMAN (1955), HARVEY (1956), MONROY (1965), TYLER and TYLER (1966b), GUSTAFSON (1969), EBERT and SUSSEX (1970), HÖRSTADIUS (1973), ISHIKAWA (1975a) and OKAZAKI (1975).

Gametes of echinoderms have been obtained after natural spawning (p. 955), after gonad dissection (p. 960), or after artificially induced spawning (p. 961). In many asteroids and echinoids, experimental fertilization is easy to obtain even in species with yolk-rich eggs such as *Heliocidaris erythrogramma* (MORTENSEN, 1921). Increased sea-water alkalinity has been reported to enhance the fertilizability (MORTENSEN, 1913). Yolk-rich eggs of sea-stars are often difficult to fertilize artificially; in several cases, insemination has remained unsuccessful; the same holds for holothuroids.

Large numbers of sea-urchin eggs are counted in Petri dishes with a ruling on the underside, by employing SHAPIRO'S (1935) counter, or by using a Coulter counter with a 280- μ m aperture (HINEGARDNER, 1975).

The gametes should be used for fertilization as soon as possible after their release. Spermatozoa can be stored, after centrifugation (sea-water removal), at low temperatures (e.g. on ice). Once they are activated, their life span is reduced to 30 to 50 mins. The fertilization potential of sea-urchin spermatozoa can be prolonged and the fertilization reaction improved by treating spermatozoa and eggs with metal-chelating agents, e.g. amino acids, versene, DEDTC, oxine, cupron (TYLER, 1953). For example, EDTA (ethylene diamine tetra-acetic acid; 10^{-3} molar in sea water, pH 8) effectively prolongs the activity period of spermatozoa suspended in sea water (see also CLELAND, 1953). Once exposed to free sea water, the fertilizing

capacity of urchin sperm can also be prolonged if the pH is reduced to 6 with dilute hydrochloric acid (OSANAI, 1975). It is more difficult to store the eggs of echinoids. According to HINEGARDNER (1975), eggs of *Strongylocentrotus purpuratus* can be kept at 5° C for about 24 hrs without significant loss of fertilizability, but at

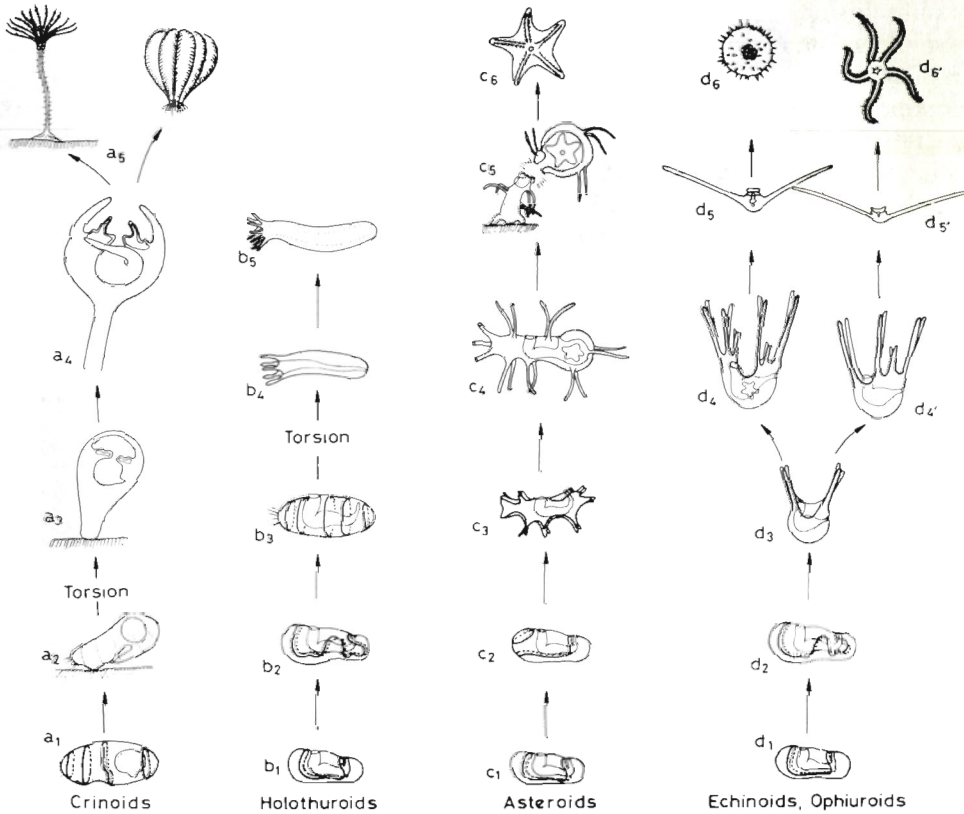

Fig. 5-97: Typical echinoderm larval types. Crinoids— a_1 : Doliolaria, free; a_2 : doliolaria, settled; a_3 : late cystidea; a_4 : pentacrinula; a_5 : fixed (left) and free (right) young crinoid. Holothuroids— b_1 : dipleurula; b_2 : auricularia; b_3 : doliolaria; b_4 : pentactula; b_5 : young sea-cucumber. Asteroids— c_1 : dipleurula; c_2 : early bipinnaria; c_3 : late bipinnaria; c_4 : brachiolaria; c_5 : attached brachiolaria with star portion breaking off; c_6 : young sea-star. Echinoids— d_1 : dipleurula; d_2 : bipinnaria; d_3 : early pluteus; d_4 : echinopluteus; d_5 : late echinopluteus; d_6 : young sea-urchin. Ophiuroids— d_1 : dipleurula; d_2 : bipinnaria; d_3 : early pluteus; d_4' : ophiopluteus; d_5' : late ophiopluteus; d_6' : young brittle-star. Thick lines represent ciliated bands. (After NICHOLS, 1962; modified; reproduced by permission of Hutchinson & Co. Ltd.)

higher temperatures they deteriorate rapidly. Eggs of *Lytechinus pictus* can be stored overnight at 10° C; lower temperatures are detrimental; the survival is improved under oxygenation and slow stirring (see also RUNNSTRÖM, 1933; HARVEY, 1956; and OSANAI, 1975).

For fertilization, a small amount of a dilute suspension of sea water and sperm is stirred into a suspension of eggs in sea water. It is important to reduce the number

of spermatozoa to the minimum level necessary for fertilizing a sufficient number of eggs. Excess spermatozoa may cause polyspermy and abnormal development. HINEGARDNER (1975) recommends a ratio of about 50 spermatozoa to 1 egg. After fertilization, the remaining free spermatozoa and possible debris are removed by allowing the eggs to settle by decanting or siphoning off most of the water and by subsequent addition of fresh sea water. It may be necessary to repeat this cleaning procedure several times. ALLEN and NELSON (1910) filtered sea-urchin eggs 10 to 15 mins after fertilization through fine gauze which allowed the eggs to pass, but which retained most debris. Immediately after a spermatozoon has entered the egg, the fertilization membrane is raised; shortly after, the hyaline layer forms. Male and female pronuclei fuse 10 to 20 mins after sperm entry, and mitosis and first cleavage occur after 1 to 2 hrs depending on temperature.

Echinoderm eggs have been fertilized in natural and artificial sea water. In Ca-free sea water, sea-urchin spermatozoa fail to perform 'boring movements' and no fertilization takes place. After adding a small amount of Ca, the spermatozoa start boring and fertilization begins (YANAGIMACHI, 1953). Numerous chemical and physical agents have been used to activate sea-urchin eggs artificially and to obtain parthenogenetic development (ISHIKAWA, 1975b; VON LEDEBUR-VILLIGER, 1975). Several authors have studied the dependence of embryonic and larval development on sea-water composition and have analyzed the effects of specific cations and anions (e.g. HERBST, 1892, 1897, 1904; CHAMBERS and CHAMBERS, 1949; CZIHAK, 1962; LALLIER, 1964; GUSTAFSON, 1969; VACQUIER, 1971; RUNNSTRÖM and IMMERS, 1971; RUNNSTRÖM and co-authors, 1972). The discovery of HERBST (1892) that lithium ions added to the culture water vegetalize sea-urchin eggs has attracted particular attention and prompted a series of investigations which revealed that numerous other substances are also capable of vegetalizing or animalizing echinoderm embryos and larvae. For details consult the reviews by HÖRSTADIUS (1973) and LALLIER (1975).

Underripe echinoid eggs fertilize and develop better after pretreatment with sodium periodate. In *Psammechinus miliaris*, for example, underripe eggs, inseminated in a solution of 0.1 ml of 0.001N sodium periodate 2 ml⁻¹ of sea water, exhibited a 68 to 94% increase in membrane formation (RUNNSTRÖM and KRISZAT, 1950). Overripe sea-urchin eggs fertilize better in calcium-free sea water than in natural sea water (OKADA, 1950).

For egg incubation, beakers, Petri dishes or funnels into which sea-water-washed air enters from below (similar to fish-egg incubators, p. 970) are used. A few investigators have added antibiotics (e.g. 100 I.U. penicillin ml⁻¹) in order to counteract bacterial growth (e.g. TYLER and ROTHSCHILD, 1951). Providing temperature and salinity are adjusted to species-specific requirements and the culture medium is sufficiently aerated, incubation of fertilized echinoderm eggs is largely unproblematic. If the eggs are spread out in a single layer in a shallow dish, aeration may not be necessary. Methods for handling sea-urchin eggs have been presented or reviewed by COSTELLO and co-authors (1957), HINEGARDNER (1975) and OSANAI (1975).

In a suspension of unfertilized sea-urchin eggs, LILLIE (1912, 1919) discovered a substance which agglutinates homologous spermatozoa. This substance, for which LILLIE coined the term 'fertilizin', originates from both the plasma membrane and the jelly coat (TYLER, 1948), as well as from the cortical vesicles (MOTOMURA,

1953, 1960). On the spermatozoon surface, LILLIE found another substance, antifertilizin. Although many details of the fertilization process remain to be analyzed, it seems that fertilizin and antifertilizin are cooperative factors which control egg-sperm affinities and facilitate the attachment of spermatozoa to the egg surface. LILLIE suggested that these two substances provide species specificity to the gametes, similar to the antigen-antibody relationship, and that they constitute a barrier against cross fertilization between gametes of heterospecifics.

Hatching of sea-urchin embryos is facilitated by the release of a hatching enzyme. The hatching enzyme has been discovered in the urchin *Hemicentrotus pulcherrimus* by ISHIDA (1936). Later it was also found in *Arbacia punctulata* by KOPAC (1941), as well as in *Paracentrotus lividus* and *Sphaerechinus granularis* by ISHIDA (1967). YASUMASU (1958, 1961) purified and crystallized the enzyme of *Anthocidaris crassispina* and determined the molecular weight to be about 13,000 (YASUMASU, personal communication to OKAZAKI, 1975). According to OKAZAKI, hatching-enzyme release begins as early as the 8th cleavage and attains a maximum at the 9th cleavage; the urchin embryos escape from the digested fertilization membrane after the 10th cleavage. In *H. pulcherrimus*, the hatching enzyme becomes detectable (homogenization) about $4\frac{1}{2}$ hrs before hatching; hatching took place about $10\frac{1}{2}$ hrs after fertilization.

Immediately after hatching, the sea-urchin blastula is practically spherical in shape; it soon lengthens in the direction of the egg axis, and the thickening of the vegetal region conveys to the blastula a pear-shaped contour. For further details regarding the subsequent development of the young urchin consult OKAZAKI (1975).

Environmental Requirements

Only for a few asteroid and echinoid species have environmental requirements for larvae been worked out to some extent. Detailed, ecological analyses have still to be performed. The information at hand has been almost exclusively produced by embryologists, physiologists and biochemists.

ALLEN and NELSON (1910) were among the pioneers in cultivating larvae of echinoderms as well as other marine invertebrates. Their main attention was focused on the echinoderms *Echinus acutus*, *E. esculentus*, *E. miliaris* and *Cucumaria saxicola*. The sea-urchins were kept in heat-sterilized, green, glass sweet-jars of 2000 cm³ capacity, covered with glass stoppers. The jars contained sterile, activated-charcoal treated sea water, filtered through a Berkefeld filter. The jars were placed in moderate daylight and water temperatures maintained between 10° and 19° C. Between 50 and 75 echinoderm larvae were placed in each jar. Several larvae of *E. acutus* and *E. esculentus* completed metamorphosis.

Larvae of *Arbacia punctulata*, *Lytechinus pictus*, *L. variegatus*, *Strongylocentrotus purpuratus* and *Echinometra mathaei* have been reared to metamorphosis by HINEGARDNER (1969). The maximum number of larvae that could be kept in a given volume of sea water depended on the developmental stage. HINEGARDNER considers 1 larva ml⁻¹ a 'comfortable maximum'. Slow water movement was provided by a magnetic stirrer assembly. The culture enclosures (polystyrene dishes, 9.5 cm diameter, 7 cm high) were covered by lids with two small holes: one near the edge,

the other in the centre; both served to ventilate the culture; the centre hole held the axle (monofilament nylon line) of the floating magnet which stirred each individual culture enclosure. Two paddles were attached to the floating magnet with a total area of 2 cm² (designed to minimize potential contacts with the larvae). Water agitation obtained by gentle aeration generally slowed development and reduced the length of larval spines. Of the species mentioned above, only larvae of *A. punctulata* grew well without water movement; they could even be raised in test tubes.

Of the echinoid larvae raised by HINEGARDNER (1969), those of *Arbacia punctulata* are easiest to cultivate, but young urchins tend to hold on to any solid substratum with tenacity and hence are difficult to transfer without tearing off their tube feet; the young urchins are less hardy than the larvae. *Lytechinus pictus* larvae cause no problems and the young urchins grow well under laboratory conditions. *L. pictus* larvae were able to feed about 2 days after hatching. Under optimum environmental conditions, they metamorphosed in about 1 month. About 80% of the plutei could be raised to metamorphosis. The young urchins began to grow appreciably 8 to 10 days after the completion of metamorphosis. *L. variegatus* larvae are the least hardy. The larvae of *Echinometra mathaei* are smaller than those of the four species raised by HINEGARDNER, thus creating difficulties in handling; mortalities in young urchins are usually very high. For ecological studies, larval concentrations should not exceed 1 individual 5 ml⁻¹, and 50% of the culture water should be renewed each day unless a recirculation system with culture-water treatment (Chapter 2, p. 100) is used. Larvae of *A. punctulata*, *L. pictus*, *L. variegatus* and *E. mathaei* grow best at 22° to 24° C; larvae of *Strongylocentrotus purpuratus* require 15° C or lower. Temperature effects on the development of non-feeding *Paracentrotus lividus* larvae have been studied by BOUGIS (1971).

According to HINEGARDNER (1975), metamorphosis of echinoids is not spontaneous, but must be induced by offering a suitable substratum with a bacterial film (see also p. 659, p. 800, and p. 918). As soon as the substratum has been accepted, the swimming larva transforms rapidly (ca 1 to several hrs) into a small sea-urchin with 5 tube feet (CZIHAK, 1960; CAMERON and HINEGARDNER, 1974). After 8 to 10 days, the gut has formed and the young sea-urchin begins to feed.

Nutritional Requirements

The early larvae of most echinoderms cultivated thus far do not require external food. However, the completion of metamorphosis is usually possible only when suitable food items are available in sufficient concentrations. Detailed studies on nutritional requirements of echinoderm larvae have still to be conducted. Only for some asteroids and echinoids is appreciable information available.

While early investigators such as ALLEN and NELSON (1910) considered diatoms (*Nitzschia closterium* forma *minutissima*) to be the most suitable food for echinoid larvae, modern culturists have found the food value of flagellated algae to be superior. According to HINEGARDNER (1969, 1975) and others, larvae of *Arbacia punctulata* and *Strongylocentrotus purpuratus* can be reared on *Dunaliella tertiolecta*; those of *Lytechinus pictus* on *Pyramimonas* sp.; and those of *Psammechinus miliaris* on *Cryptomonas* sp., *Dunaliella* sp. and *Oxyrrhis* sp. (CZIHAK, 1960).

Chlorella vulgaris, *Chilomonas* sp. and several other small flagellates have also been used as food for echinoid larvae (e.g. RUNNSTRÖM, 1933). HINEGARDNER (1969) provided the larvae with a daily supply of algae which they would consume in 24 hrs. Prior to use, the algae were centrifuged from their culture medium and resuspended (washed) in clean sea water.

(c) Rearing of Juveniles and Adults

The major problems encountered in the cultivation of Echinodermata begin with metamorphosis. Usually the difficulties culminate during metamorphosis and in the early juvenile. Most culturists report heavy losses during these stages. Apparently, due to high metabolic activities and pronounced functional and structural reorganizations, the environmental and nutritional requirements of metamorphosing and newly metamorphosed individuals attain a maximum degree of specificity—combined with a minimum capacity of tolerance to environmental stress.

At this stage, success in cultivation depends essentially on optimization of environmental quality, careful culture-water-quality control, avoidance of rapid changes in environmental factors, and proper nutrition.

Environmental Requirements

Asteroids and echinoids are collected by hand during low tide, by dredging from a ship or by diving. For experimental or for demonstration purposes, many high schools and universities obtain live sea-stars or sea-urchins from marine stations. The 'Biologische Anstalt Helgoland' (FRG), for example, ships live *Asterias rubens*, *Echinus esculentus* and *Psammechinus miliaris* in screw-cap plastic containers filled three quarters with sea water and one quarter with oxygen; one 30-l container is used for 15 to 20 *P. miliaris*. In warm weather, the containers are packed in insulated boxes to prevent critical temperature increase. Many temperate-zone sea-stars and sea-urchins can be kept well at temperatures between 10° and 17° C. According to OSANAI (1975), some Japanese sea-urchins are shipped over 24-hr periods in a wooden box containing wet paper or fresh algae.

Most captive echinoderms have been accommodated in aerated aquaria or tanks, often in closed (Chapter 2, p. 42), but sometimes also in open (p. 39), sea-water systems; the latter pertains especially to suspension feeders. While information on crinoids and holothuroids is scarce, and while only a few culturists have attempted to maintain ophiuroids under controlled conditions, there is considerable information available on asteroids and, especially, on echinoids.

The effect of light on captive echinoderms has received little attention (e.g. HYMAN, 1955; YOSHIDA, 1966; Volume I: SEGAL, 1970; CASTILLA, 1971); direct sunlight appears to be undesirable or even harmful to most species. It seems best to place the cultures in dim daylight or dim artificial light, simulating natural diurnal illumination changes.

Juvenile *Lytechinus pictus* have been cultivated by HINEGARDNER (1969) at 22° to 24° C in plastic Petri dishes (100 or 150 diameter × 25 mm deep). At a test diameter of 2 mm, the madreporite began to develop. After 2 months, at a shell

diameter of 3.2 mm, gonadopores appeared; at the same time, gonad development began, starting from a single lobe near the gonadopore. The gonads grew ventrally and contained ripe gametes after 4 to 5 months at a test diameter of 6 mm.

HINEGARDNER (1969) used non-sterile *Nitzschia* sp. as food organisms for the young urchins. The diatom was first grown in the culture dishes until the bottom was covered (lightly for young urchins, more heavily for older ones), then the medium was diluted 50% with sea water and the young urchins were introduced. The dishes were kept in an illuminated incubator. Under such conditions, diatom growth tended to counterbalance grazing for some time; however, ultimately, either all diatoms were consumed or they grew so thick that they began to die. In either situation, the urchins had to be transferred to a newly prepared culture dish. If properly maintained, the young urchin's test diameter increased at the rate of 1 mm every 18 days. According to HINEGARDNER, somewhere around 50% of the young *Lytechinus pictus* plutei can probably be grown to maturity. Ripe gametes can be obtained from urchins about 4 to 5 months old; hence, generation time is about 6 months or less.

Nutritional Requirements

Our present knowledge on the natural nutritional requirements of juvenile and adult echinoderms is largely based on occasional observations. While a considerable amount of detail has been accumulated in this way, systematic experimental analyses of the nutritional requirements of cultivated Echinodermata have remained exceptions. An important review on feeding, digestion and nutrition has been presented by FERGUSON (1969b). Functional and structural aspects of echinoderm digestive systems have received attention from HYMAN (1955) and ANDERSON (1966). Additional information can be found in FEDER and CHRISTENSEN (1966) and FELL (1966a, b). The carbohydrate metabolism of echinoderms has been reviewed by DOEZEMA (1969), the lipid metabolism by FAGERLUND (1969), and the biochemical constitution of some echinoderms by GIESE (1966).

A comprehensive documentation by LAWRENCE (1975) deals with the relationship between marine plants and sea-urchins—covering such aspects as the food eaten in the field and food preferences, as well as the feeding process, digestion, absorption and assimilation. LAWRENCE concludes that marine plants generally form a major portion of the sea-urchin diet, but that animals and substrate matter may also contribute significantly. Whether the field diet of sea-urchins is primarily due to preferences or to limitations in food availability remains to be investigated. The nutritional role of dissolved organic matter, detritus and plankton awaits critical analysis.

Echinoderms feed on a large variety of organic materials and display a large variety of feeding types (see also Volume II: PANDIAN, 1975). Most representatives are nutritionally unspecialized, omnivorous opportunists. This conveys to them considerable nutritional plasticity and a wide ecological potential in areas with acceptable climatic conditions. Some echinoderms prefer a certain type of food if given a choice. The major feeding types of echinoderms include (i) suspension feeding (e.g. in some crinoids, holothuroids, asteroids, ophiuroids); (ii) deposit feeding (e.g. in crinoids, holothuroids, asteroids such as *Patiria miniata*, ophiuroids);

(iii) prey seizing (e.g. in asteroids such as *Asterias rubens*); (iv) rasping (e.g. in echinoids); (v) skin digestion and absorption (e.g. in asteroids and echinoids); (vi) digestion in external stomachs (e.g. in asteroids such as *Asterias rubens* and related forms); (vii) in-bottom sediment swallowing (e.g. in holothuroids, echinoids).

Major denominators of dietary selectivity are echinoderm size and feeding apparatus, prey size and defensive prey principles, physiological state and season. Under *in situ* conditions, small *Asterias forbesi* and *A. rubens*, for example, feed on oyster spat or barnacles, while larger individuals prey primarily upon clams, oysters and mussels (GALTSOFF and LOOSANOFF, 1939; HANCOCK, 1955), and in the sea-urchin *Strongylocentrotus intermedius*, the percentage of calcareous algae consumed decreases with increasing urchin size (KAWAMURA and TAKI, 1965). Where the food offered was insufficient, several sea-stars and sea-urchins became cannibalistic, especially under crowded conditions (e.g. GALTSOFF and LOOSANOFF, 1939; HARVEY, 1956; HANCOCK, 1957); however, generally only moribund individuals suffered (FERGUSON, 1969b).

Several echinoderms have been shown to exhibit diurnal changes in locomotory and feeding activities; many are nocturnal. *Astropecten polyacanthus*, for example, move around primarily at dusk and dawn, but stay beneath the sediment surface at midday and midnight (MORI and MATUTANI, 1952). *A. aranciacus* crawl about on the sea bottom mainly at night (BURLA and co-authors, 1972). *Diadema setosum* sit motionless in sheltered areas of coral reefs during the day and search for food at night (FRICKE, 1974).

The potential significance of micro-organisms to digestion and related aspects of echinoderm nutrition remains to be fully explored. While it is possible or even likely that echinoderms derive nutritional benefits from the activities of their intestinal flora and/or by digesting part of the flora itself, definite proof for such assumptions has still to be provided. First demonstrated by WEESE (1926), the presence of bacteria in echinoid guts has been confirmed by several authors. LASKER and GIESE (1954) showed that the bacterial flora in the intestine of *Strongylocentrotus purpuratus* is capable of digesting agar and tissues of the red alga *Iridaea flaccidum*. According to EPPLEY and LASKER (1959), bacteria may have been responsible for the alginase recorded by them in the gut of *S. purpuratus*. CASTRO (1969) demonstrated that bacteria inhabiting faecal pellets of *Echinothrix calamaris* can digest agar plates containing tissue of the calcareous red alga *Porolithon* sp.

PRIM and LAWRENCE (1975) report degradation of *Ulva lactuca* and *Ercheuma nudum*, but not of *Caulerpa prolifera* by gut bacteria of the echinoids *Arbacia punctulata* and *Lytechinus variegatus*. *Diplanthera wrightii* and *Thalassia testudinum* were only slightly degraded. However, bacteria isolated from the intestines of the echinoids *Mellita quinquiesperforata* and *Encope aberrans* could not degrade any of the marine plants listed above. According to PRIM and LAWRENCE, mixed and some isolated bacteria from the gut of *L. variegatus* were able to utilize xylose, rhamnose, glucose, galactose, laminarin, carageenan, starch and agar, but not cellulose or chitin. These results, while demonstrating some degree of nutritional opportunism of the intestinal microflora, cannot yet sufficiently explain the nutritional versatility of most echinoids thus far investigated. As in other marine invertebrates, intestinal echinoderm bacteria may affect vitamin and micro-nutrient dynamics (e.g. FERGUSON, 1969b). Surprisingly, antibiotic application did

not seem to interfere measurably with growth of *Strongylocentrotus purpuratus* (FARMANFARMAIAN and PHILLIPS, 1962).

The role of dissolved organic matter (DOM) in the nutrition of echinoderms requires detailed investigation. Apparently, in many echinoderms, external DOM can significantly affect the uptake dynamics of energy and matter. For details consult the following reviews: FERGUSON (1969b), Volume II: PANDIAN (1975, p. 72), Volume IV: CONOVER (in press) and WANGERSKY (in press). *Asterias forbesi*, *A. vulgaris*, *Echinaster echinophorus*, *Henricia sanguinolenta*, *Leptosynapta inhaerens*, *Lytechinus variegatus*, *Ophiactis arenosa*, *O. simplex* and *Ophionereis annulata* have been shown to be capable of absorbing significant amounts of amino acids and glucose from low ambient concentrations (STEPHENS and SCHINSKE, 1961; STEPHENS and VIRKAR, 1966; FERGUSON, 1967a, b, 1970, 1971; STEPHENS, 1972). According to FERGUSON (1967b), most of the dissolved organic substances are assimilated directly into epidermis cells and do not seem to move on into internal tissues. Possibly, the peripheral tissues depend on ambient, dissolved nutrients, while the ingested food supports primarily internal tissues. The pedicellariae may cooperate with the external assimilation mechanism. Small organisms caught by pedicellariae are digested by the epidermis (see below) and thus contribute to external nutrition. In *Holothuria scabra*, autoradiographic studies have indicated to KRISHNAN (1971) ^{14}C -glucose transport through amoebocytes and coelomocytes, and also via diffusion. According to PAVILLON (1976), even at natural ambient concentrations, dissolved amino acids may affect protein synthesis in developing eggs of the echinoids *Arbacia lixula* and *Paracentrotus lividus*. However, the disposition of dissolved amino acids incorporated through cell membranes may be complex, and definite statements about their ecological significance require the use of different labels and techniques (PEARSE and PEARSE, 1973).

A large fraction of the energy consumed by *Strongylocentrotus droebachiensis* has been assumed by MILLER and MANN (1973) to be due to DOM loss. MILLER and MANN also discuss gaps in the energy budgets of other benthic grazers and conclude that these gaps too might be accountable for by DOM loss. It seems that future nutritional studies should pay attention to both DOM uptake and release, and concentrate more on DOM exchange patterns and gradients rather than on uptake alone.

Skin digestion and absorption have been demonstrated to occur in several asteroids and echinoids. PÉQUIGNAT (1969, 1970) demonstrated that *Psammechinus miliaris* can be fed through its body wall by means of ^{14}C -labelled mussel gills. He deposited the food items either among the spines of the apical test or fed them with pincers through the mouth opening. In the former case, 33% of the total radioactivity was recovered in the digestive tract (activity of the test with spines and podia: 55%); in the latter, 63% (test activity: 23%). FERGUSON's (1969a, b) investigations on echinasterids also evidence quick and significant food absorption on the whole body surface. While FERGUSON (1967b) states that the absorbed nutrients remain largely in the epiderm, PÉQUIGNAT (1972) recorded them also in the muscle layer. In both sea-stars and sea-urchins, skin digestion ('surface feeding') and microphagy seem to be common, primitive food-uptake mechanisms (see also Volume II: PANDIAN, 1975, p. 98).

Together with epidermal secretions, migratory amoebocytes can predigest

materials on the echinoderm's body surface (PÉQUIGNAT, 1966a, b; PÉQUIGNAT and TIFFON, 1967). In *Asterias rubens*, *Echinocardium cardium*, *Psammechinus miliaris* and *Ophiothrix fragilis*, the digestive products are absorbed directly through the epidermis or carried to the gut. *P. miliaris* forms a 'digestive pouch' between its oral surface and the substratum, and large numbers of 'spherulocytes' move out through the branchial tufts into this chamber, where they digest organic matter on the substrate surface, thus facilitating the partially dissolved products to be sucked up in the gut. It is assumed that also other organic debris which is sometimes

Table 5-88

Food organisms utilized by crinoids under *in situ* conditions. (After FELL, 1966a; reproduced by permission of Wiley-Interscience)

Group, genus	Habitat	Type of food
Stalked sea lilies		
<i>Metacrinus</i>	Deep waters	{ Mainly small amphipods, copepods, and larval stages of malacostracans; also diatoms, Protozoa, and detrital material
<i>Bathycrinus</i>	Deep waters	
<i>Rhizocrinus</i>	Deep waters	
<i>Endoxocrinus</i>	Deep waters	
<i>Neocrinus</i>	Shallow waters	
Stalked phases of comatulids		
<i>Antedon</i>	Shallow waters	{ Mainly diatoms; also minute algae and crustaceans
<i>Isometra</i>	Antarctic shelf waters	Larval stages of <i>Isometra</i>
Vitellaria phases of comatulids		
<i>Antedon</i>	Shallow waters	Protozoa; pelagic larvae
Feather-star phases of comatulids		
<i>Antedon</i>	Shallow waters	{ Mainly dinoflagellates, diatoms, and minute crustaceans
Tropical comasterids	Coral reefs	{ Unicellular and filamentous algae, diatoms, foraminiferans; some minute crustaceans

collected and carried on the body serves a nutritional function: apparently, it is partially digested by spherulocytes and absorbed by the epidermis.

In the following paragraphs, the feeding habits of crinoids, holothuroids, asteroids, echinoids and ophiuroids are briefly described and characterized.

Crinoids are largely omnivorous suspension feeders (Table 5-88). With outstretched arms and pinnules and with the podia erect, sessile crinoids retain small planktonic organisms and detritus particles from the passing water. Potential small food items are whipped into the ambulacral grooves by the podia. Mucus secreted by epithelial glands of the podia and the ambulacral groove aid in entangling the food, which is then transported by ciliary action down the arms and into the mouth. In addition to such free-water filter feeding, crinoids such as *Heterometra savignyi* collect organic matter from the substrate surface (especially in stagnant

water) and mop up the water-surface film (during the day at incoming tide). Food uptake and food transport in these forms are performed by the ambulacral feet (MAGNUS, 1964).

The feeding responses of 5 reef-dwelling Caribbean comatulid crinoids—*Analcidometra caribbea*, *Comactinia echinoptera*, *Nemaster grandis*, *Neocomatella pulchella* and *Tropiometra carinata carinata*—have been studied by MEYER (1973). In the presence of unidirectional water movement or wave oscillation, all 5 species form a food-filtration fan with their arms and pinnules ensuring maximum exposure of the tube feet to food-carrying currents. In turbulent water and in the presence of reduced current velocities, a radial feeding posture is assumed: the arms extend in many directions and the pinnules are held in a 4-row radial arrangement. The distribution of the 5 species suggested to MEYER that they aggregate where water movements concentrate suspended small-particle food items. As in other crinoids, feeding behaviour and feeding posture are intimately related to the prevailing water-movement regime.

Definite information of nutritional requirements of captive crinoids has not come to the reviewer's attention. For details regarding the feeding mechanism employed consult NICHOLS (1960), MAGNUS (1963a, b, 1964), ANDERSON (1966), CLARK and CLARK (1967), FERGUSON (1969b) and Volume II: PANDIAN (1975).

Holothuroids are tentaculate (buccal tube feet) suspension and/or deposit feeders; many move slowly over or burrow through the sediment, sweeping the area ahead or swallowing large amounts of mud or sand (MACGINITIE and MACGINITIE, 1949; see also NICHOLS, 1962, and ANDERSON, 1966). Some sit in the substrate, form a collecting funnel with their buccal tube feet, and collect sedimenting detritus particles. A few holothuroids are pelagic, e.g. the elaspod genus *Pelagothuria*, which swims with the aid of a membrane formed of parts of its body wall and tube feet. Apparently, *Pelagothuria* species feed on plankton. Benthic holothurians trap small organisms such as diatoms, protozoans and small invertebrates in mucus on their tentacles. Suspension feeders (e.g. *Cucumaria pseudopopilifera*) stretch out their highly branched tentacles and filter the passing sea water. Deposit feeders (e.g. *Thyone* species) sweep or mop their tentacles over the nearby sea bottom. From time to time, a tentacle is withdrawn and wiped through the pharynx, where adhering food particles are retained as the tentacles are pulled out again (Volume II: PANDIAN, 1975, p. 91). Sediment swallows may completely fill themselves with sand and empty the sand again three times a day (e.g. *Stichopus*: CROZIER, 1918). *Stichopus japonicus* is capable of some degree of selection (TANAKA, 1958) as is *Leptosynapta inhaerens* (SANDERS and co-authors, 1962). Also in *Cucumaria elongata*, differences in particle size of ambient mud and gut contents suggest the presence of selectivity and of a particle-size sorting mechanism (FISH, 1967).

According to CHOE (1962), *Stichopus japonicus* produces amylase, cellulase, pectinase, proteinase, dipeptidase, esterase and lipase. However, YOKOE and YASUMASU (1964) found no cellulase in *S. japonicus* nor in *Holothuria monacaria* or *Leptosynapta* sp. For further details on digestive enzymes and absorption consult D'AGOSTINO and FARMANFARMAIAN (1960), FARMANFARMAIAN (1963) and ANDERSON (1966); for ecological aspects of nutrition, PAWSON (1966).

In asteroids, prey seizing (e.g. predation on corals, molluscs, annelids, crustaceans and fishes), suspension feeding (ciliary mucoid feeding) and deposit feeding

Table 5-89

Food items consumed under *in situ* conditions (unless otherwise specified) by sea-stars (After FEDER and CHRISTENSEN, 1966; modified; reproduced by permission of Wiley-Interscience)

Species	Habitat or distribution	Type of food	Author
<i>Acanthaster planci</i>		Up to 4 months herbivorous, then coral feeders	YAMAGUCHI (1974a,b)
<i>A. planci</i>	Australia, Red Sea	Coral polyps; possibly gastropods	MORTENSEN (1931); CLARK (1950); GOREAU (1964)
<i>Anseropoda placenta</i>	Shetland Islands to and including Mediterranean Sea	Mainly crustaceans; also molluscs and echinoderms	HUNT (1925); MORTENSEN (1927)
<i>Asterias amurensis</i>	Japanese waters	Mainly crabs and shrimps; also clams	HATANAKA and KOSAKA (1959); INO and co-authors (1955)
<i>A. forbesi</i>	Maine to Gulf of Mexico	Bivalves (mussels, clams, scallops, oysters)	MEAD (1900); GALTSOFF and LOOSANOFF (1939)
<i>A. rubens</i>	White Sea and Iceland down to Senegal coast, British coasts	Primarily bivalves, but also gastropods, echinoderms (<i>A. rubens</i> , echinoids, ophiuroids); crustaceans (especially barnacles)	MACANDREW and BARRETT (1857); BLEGVAD (1914); HUNT (1925); MORTENSEN (1927); HANCOCK (1955)
<i>A. vulgaris</i>	In shallow water from Labrador to Long Island Sound, deep water to Cape Hatteras	Oysters; scallops	NEEDLER (1941); DICKIE and MEDCOF (1963)
<i>Asterina gibbosa</i>	British seas to Canaries, Azores, and Mediterranean Sea	Molluscs; also worms and echinoderms (ophiuroids)	MILLIGAN (1916b); MORTENSEN (1927)
<i>A. pectinifera</i>	Japan Sea	Predator	DJAKONOV (1938)
<i>A. regularis</i>	New Zealand	Scavenger and predator (chiefly mussels and small gastropods)	BENNETT (1927)
<i>Asterinopsis Aucklandensis</i>	Subantarctic islands of New Zealand	Mainly detritus	FELL (1953)
<i>Astrometis sertulifera</i>	Gulf of Calif. to Santa Barbara (USA)	Small gastropods; amphineurans	JENNINGS (1907)
<i>Astropecten acanthifer</i>	Mozambique	Gastropods; bivalves	MACNAE and KALK (1962)
<i>A. armatus</i>	Southern California to Ecuador	Snails	MACGINITIE and MACGINITIE (1949)
<i>A. articulatus</i>	Southeastern coast of USA	Mainly gastropods, but all types of bottom organisms are taken	WELLS and co-authors (1961); HULINGS and HEMLAY (1963)
<i>A. auranciacus</i>	Gulf of Naples	Bivalves; snails; scaphopods; sea-urchins; sea-stars; holothurians; fishes	HAMANN (1885); LUDWIG (1897)
<i>A. bispinosus</i>	Gulf of Naples	Mainly bivalves and snails	SARS (1857); LUDWIG (1897)
<i>A. cingulatus</i>	Argentine coast	Mainly molluscs	CARCELLES and PARODIZ (1938); CARCELLES (1944)
<i>A. formosus</i>	Korea	Bivalves	SLADEN (1879)
<i>A. granulatus</i>	Mozambique	Small gastropods	MACNAE and KALK (1962)
<i>A. irregularis</i>	Norwegian coast to Morocco, Mediterranean	Mainly bivalves and gastropods; also polychaetes, small crustaceans, young asteroids, ophiuroids, echinoids	EICHELBAUM (1910); BLEGVAD (1914); HUNT (1925); KISCH (1958)
<i>A. javanicus</i>	Malacca	Mainly bivalves	BEDFORD (1900)
<i>Bathyiaster loripes obesus</i>	Antarctic Ocean	Possibly settling detritus	CLARK (1963)
<i>Brisingella coronata</i>	Norway to Azores and Cape Verde Islands; Mediterranean Sea	Small animals, especially foraminiferans	MORTENSEN (1927)
<i>Calvaasterias laevigata</i>	Sub-Antarctic islands of New Zealand	Isopods; chitons; gastropods	FELL (1953)
<i>C. suteri</i>	New Zealand	Small sedentary animals; (<i>Modiolus ater</i> , <i>Mytilus</i> , <i>Elminius</i>)	BENNETT (1927)
<i>Coscinasterias calamaria</i>	New Zealand	In captivity: small gastropods and Mytilidae, brachiopods; small organisms caught with pedicellariae	YOUNG (1926); BENNETT (1927); DARIN (1953)

Table 5-89—Continued

Species	Habitat or distribution	Type of food	Author
<i>Crossaster papposus</i>	North Atlantic Ocean	Sea anemones; mainly asteroids (<i>Asterias rubens</i> , <i>Marthasterius glacialis</i>). Occasionally <i>Echinocardium</i> sp.; also molluscs and bryozoans	GRIEG (1913); MILLIGAN (1916a); BLEGVAD (1914); HUNT (1925); MORTENSEN (1927); BULL (1934); HANCOCK (1958)
<i>Ctenodiscus crispatus</i>	Bering Sea to Sea of Japan, south along American coast to Gulf of Panama, Arctic Ocean, North Atlantic Ocean	Mud (detritus)	FISHER (1911); GISLÉN (1924); MORTENSEN (1927)
<i>Culcita schmideliana</i>	Java	Echinoids (mainly <i>Echinometra lacunter</i>)	SLUITER (1889)
<i>Dermasterias imbricata</i>	Sitka, Alaska to Monterey Bay (USA)	In captivity; <i>Mediaster aequalis</i> ; injured holothurians and crustaceans	CHRISTENSEN (unpub.); WARD (1965)
<i>Dytaster spinosus</i>	Indian Ocean (Deep sea)	Scavenger	BRUUN and WOLFF (1961)
<i>Evasterias troschelii</i>	North Pacific Ocean	Mussels; clams	CHRISTENSEN (1957)
<i>Henricia leviuscula</i>	Alaska to San Diego (USA)	Probably suspended particulate matter	ANDERSON (1960)
<i>H. sanguinolenta</i>	North Atlantic and North Pacific Oceans	Suspended particulate matter	ANDERSON (1960); RASMUSSEN (1965)
<i>Hymenaster bleqvadi</i>	Deep sea (below 6000 m)	Small snails, possibly clams	MADSEN (1956)
<i>H. pellucidus</i>	Norwegian Sea, east Greenland, Siberian Sea, Faroe channel	Ophiuroids (one case)	MORTENSEN (1927)
<i>Hyphalaster</i> spp.	Deep sea	<i>Globigerina</i> ooze; mud; occasionally plant debris	ALCOCK (1893); MADSEN (1961)
<i>Leptasterias aequalis</i>	British Columbia to Santa Catalina Island (USA)	Small mussels, gastropods, barnacles	HEWATT (1937)
<i>L. hexactis</i>	Alaska to Cape Flattery	Small gastropods	OSTERUD (1918)
<i>Luidia ciliaris</i>	Faroe islands to Cape Verde islands, Mediterranean	Almost entirely echinoderms: sea-stars, brittle-stars, echinoids, sea-cucumbers	MORTENSEN (1913); HUNT (1925)
<i>L. clathrata</i>	West coast of Florida, Texas coast, Virginia coast	Sea-urchins; large amounts of sediment; omnivorous; foraminiferans	CLARK (1934); HULINGS and HEMLAY (1963)
<i>L. foliolata</i>	Southeast Alaska to San Diego (USA)	Ophiuroids; scaphopods (<i>Dentalium</i>)	FISHER (1911)
<i>L. sarsi</i>	Norway to Cape Verde Islands	Mainly echinoderms, but also polychaetes, molluscs, and crustaceans	MORTENSEN (1927); FENCHEL (1965)
<i>Marthasterias glacialis</i>	Northeast Atlantic Ocean and Mediterranean Sea	Very voracious; mainly molluscs, but also crustaceans, echinoderms, and fishes	MACANDREW and BARRETT (1857); MORTENSEN (1927)
<i>Myzoderma sacculatum</i>	North Pacific Ocean	Shrimp	FISHER (1928a)
<i>Odontaster validus</i>	Antarctic Ocean	Omnivorous scavenger; diatoms; small crustaceans; seal feces	CLARK (1963); PEARSE (1965)
<i>Orcaster reticulatus</i>	West Indies	Possibly sponges	THOMAS (1960)
<i>Orthasterias kochleri</i>	North Pacific Ocean	In captivity; squid; crustaceans; fishes	FISHER (1928a)
<i>Patiria miniata</i>	Sitka, Alaska to Baja, California	Omnivorous	MACGINITIE and MACGINITIE (1949); ANDERSON (1959)
<i>Parachaster</i> sp.	Deep sea	<i>Globigerina</i> ooze	ALCOCK (1893)
<i>Pectinaster hispidus</i>	Deep sea	Largely molluscs; crustaceans	ALCOCK (1893)
<i>Pedicellaster magister</i>	North Pacific Ocean	Gastropods	FISHER (1928a)
<i>Pentaceraster gracilis</i>	Portuguese East Africa	Pearl oysters	SIMPSON and BROWN (1910)
<i>Pisaster ochraceus</i>	Sitka, Alaska to Ensenada, Baja, California	Primarily mussels and barnacles; also gastropods	FEDER (1959)
<i>P. giganteus</i>	Vancouver Island, B.C. to Baja, California	Mussels; barnacles	FARMANFARMAIAN and co-authors (1958); FEDER (unpub.)
<i>P. brevispinus</i>	Sitka, Alaska to Southern California	Clams; mussels; barnacles; sand dollars	MACGINITIE and MACGINITIE (1949); FARMANFARMAIAN and co-authors (1958); SMITH (1961)

Table 5-89—Continued

Species	Habitat or distribution	Type of food	Author
<i>P. giganteus</i> } <i>P. ochraceus</i> }	Santa Barbara, Calif. (USA)	Mainly bivalves and gastropods, especially <i>Mytilus edulis</i> , <i>M. californianus</i>	LANDENBERGER (1968)
<i>Pontaster tenuispinus</i>	Siberian Sea to Bay of Biscay, Davis Strait to 42°N on American coast	Minute organisms; detritus	MORTENSEN (1927)
<i>Porania pulvillus</i>	British waters	Small-particulate material	GEMMILL (1915)
<i>P. antarctica glabra</i>	Antarctic Ocean	Possibly detritus	CLARK (1963)
<i>Porcellanaster</i> sp.	Deep sea	<i>Globigerina</i> ooze	ALCOCK (1893)
<i>P. coeruleus</i>	Deep sea	Mud; sea urchins; possibly scavenger and facultative predator	MADSEN (1961)
<i>Poraster superbus</i>	Portuguese East Africa	Pearl oysters	SIMPSON and BROWN (1910)
<i>Protoreaster lincki</i>	Portuguese East Africa	Pearl oysters	HERDMAN (1906); SIMPSON and BROWN (1910)
<i>Pisaster andromeda</i>	Murman coast to Cape Verde Islands and Azores, American coast from Davis Strait to 38°N.	Mainly bivalves; also diatoms, foraminiferans, echinoderms, crustaceans	GRIEG (1902); EICHELBAUM (1910)
<i>P. pectinatus</i>	Deep water; Bering Sea	Almost exclusively molluscs (bivalves and scaphopods)	SOKOLOVA (1957)
<i>Pteraster tessellatus</i>	Bering Sea and along North American coast to Washington	Sponges and hydroids	RODENHOUSE and GUBERLET (1946)
<i>Pycnopodia helianthoides</i>	Unalaska (Aleutian Islands) to San Diego (USA)	Clams; gastropods; crustaceans (crabs, barnacles); echinoderms (asteroids, sea-urchins); occasionally algae, sponges	KJERSKOG-AGERSBORG (1918); FISHER (1928a); MACGINITIE and MACGINITIE (1949)
<i>Rathbunaster californicus</i>	North Pacific Ocean	In captivity: small crustaceans	FISHER (1928a)
<i>Rosaster florifer</i>	Deep sea	Largely molluscs; crustaceans	ALCOCK (1893)
<i>Solaster dawsoni</i>	Monterey Bay to Aleutian Islands and to Kuril Islands	Mainly asteroids	CHRISTENSEN (unpub.)
<i>S. endeca</i>	Same as for <i>C. papposus</i>	Same as for <i>C. papposus</i> , occasionally sea-cucumbers	GRIEG (1913); BLEGVAD (1914); BULL (1934)
<i>S. pazillatus</i>	North Pacific Ocean	Sea-cucumbers (<i>Molpadia intermedia</i>)	FISHER (1911)
<i>S. stimpsoni</i>	Southern Bering Sea to Oregon	Mainly asteroids	CHRISTENSEN (unpub.)
<i>Sphaeriodiscus</i> (= <i>Ceramaster</i>)	Mediterranean, Bay of Biscay, Dakar	Detritus	VEVERS (1956)
<i>Stichaster australis</i>	New Zealand	Primarily mussels	BENNETT (1927)
<i>Styrcaster</i> sp.	Deep sea	<i>Globigerina</i> ooze	ALCOCK (1893)
<i>S. horridus</i>	Deep sea	Mud containing foraminiferans; radiolarians; sponge spicules; worm-tube fragments; small snails; sea-urchin skeletal fragments	MADSEN (1961)
<i>Thoracaster magnus</i>	Deep sea	Mud-containing diatoms; foraminiferans; radiolarians; sponges	FISHER (1928b)
<i>Zoroaster carinatus</i>	Deep sea	Largely molluscs and crustaceans	ALCOCK (1893)

represent the dominating feeding types (Table 5-89). Many predatory sea stars—such as species of *Asterias*, *Coscinasterias*, *Evasterias*, *Marthasterias* and *Pisaster*—prefer bivalves as food. They hump over a bivalve, slowly pull its valves apart and squeeze their cardiac stomach through imperfectly sealed valve edges (a space of 0.1 mm is sufficient). The clam's soft parts are then digested in the everted stomach. In the stomachs of 124 field-collected *Astropecten articulatus*, WELLS and co-authors

(1961) recorded 91 different species of invertebrates. *Asterias rubens* has been sustained for years on *Balanus balanoides* and *Mytilus edulis*, as well as on meat of annelids, crustaceans, molluscs and fishes (KINNE, unpublished). Food finding and feeding stimuli in captive *Marthasterias glacialis* have been examined by VALENTINČIČ (1973); the mechanism of sea-stars for gaining access to bivalves, by FEDER (1955) and BURNETT (1960). Mollusc avoidance reactions to sea-stars have been studied by FEDER (1963), FEDER and ARVIDSSON (1967) and others.

Suspension feeding, i.e. the concentration and separation of small particulate food items from the ambient water, has been demonstrated in several asteroids (e.g. FERGUSON, 1969b). Members of the genera *Echinaster*, *Henricia*, *Linckia* and *Porania* have well developed Tiedemann pouches which enable them to employ efficient suspension feeding (HYMAN, 1955; ANDERSON, 1960, 1962). According to GEMMILL (1915), *Porania pulvillus* can be sustained exclusively on fine particulate matter, and *Henricia* species can make efficient use of phytoplankton (RASMUSSEN, 1965).

Deposit feeding, i.e. uptake of food items from the sediment surface, is well developed in *Patiria miniata* which extrudes its enormous stomach over the sea bottom surface and, via enzyme release, begins to digest practically all organic materials covered. The predigested materials are then transported into the digestive glands by flagella (MACGINITIE and MACGINITIE, 1949; ANDERSON, 1959, 1966).

Coral-feeding sea-stars include *Acanthaster planci* (CHESHER, 1969; PEARSON and ENDEAN, 1969; BRANHAM, 1973; GLYNN, 1973; YAMAGUCHI, 1973, 1974a, b). According to YAMAGUCHI (1974a), *A. planci* is herbivorous (feeding on a variety of encrusting coralline algae) during the first 4 months following metamorphosis. At a size of about 8 mm total diameter, the sea-stars begin to prey on corals (e.g. several species of the coral genera *Acropora*, *Pocillopora*, *Pavona*). During the 1-month transition period, many juvenile sea-stars are injured by coral polyps. However, except for severely damaged individuals, most coral-feeding juveniles recover and grow exponentially. Both *Acropora nasuta* and *Pocillopora damicornis* sustain full growth of juvenile *A. planci*. In YAMAGUCHI's experiments, juvenile *A. planci* killed about twice as much coral mass of *A. nasuta* as of *P. damicornis* to gain the same amount of body weight.

Most echinoids are omnivorous opportunists. Using their teeth, many rasp off pieces of multicellular algae or of living or dead animals. Captive *Strongylocentrotus purpuratus* ingested almost anything offered—including boiled egg, boiled potato and meat (LASKER and GIESE, 1954); however, meat and fruit were taken in preference to vegetables. In the field, *S. purpuratus* feeds upon numerous algae (green, red and brown), on 'surf-grass' *Phyllospadix* sp., eel grass, etc. (see also FUJI, 1962, 1967; LEIGHTON, 1966; EBERT, 1968). According to FUJI (1967), an adult *S. intermedius* of about 50 mm diameter consumes 1% to 6% of its body weight day⁻¹ (see also Volume I, p. 467); *Sargassum thunbergii*, *S. seratifolium* and *Ecklonia cava* were used as main food. In another experiment, *S. intermedius* fed on members of 12 different algae (FUJI, 1962). *S. pulcherrimus* ingested brown algae more frequently than green or red algae (OHSHIMA and co-authors, 1957; TSUNODA and co-authors, 1970). According to NAKAMURA and YOSHINAGA (1962), *Undaria pinnatifida* is favoured as food by *Heliocidaris crassipina*, *S. pulcherrimus* and *Pseudocentrotus depressus*.

Captive *Psammechinus miliaris* and *Echinus esculentus* have been cultivated over 2 years on *Ulva lactuca*, *Laminaria saccharina* and garden lettuce, as well as on meat of *Mytilus edulis*, *Mya arenaria*, *Carcinus maenas*, *Cancer pagurus*, *Clupea harengus* and *Gadus morhua* (KINNE, unpublished); they also accepted trout food, dog food, frozen shrimp and hard-boiled egg yolk. HARVEY (1956) observed the purple sea-urchin *Arbacia punctulata* eat algae, coral polyps, mussels, sand dollars and other invertebrates, as well as dead fishes.

Allocentrotus fragilis appears to exist predominantly on diatoms and other unicells (GIESE, 1961). Similarly, the antarctic *Sterechinus neumayeri* seems to feed primarily on diatoms, but also takes up other materials such as red algae and seal faeces (PEARSE and GIESE, 1966).

According to FERGUSON (1969b), there is evidence that some sand dollars subsist on nannoplankton. *Lytechinus variegatus* scoop up loose material 'like vacuum cleaners', leaving behind compact faecal pellets (FERGUSON). Several deep-sea urchins feed on fine particulate organic debris (MORTENSEN, 1938). Some echinoids are well adapted to in-bottom feeding (e.g. species of *Echinocardium* and *Moira*).

For *Strongylocentrotus intermedius*, FUJI (1967) calculated the digestibility of *Laminaria japonica* to be 65% (annual average); for *S. pulcherrimus*, NAGAI and KANEKO (1975) estimated an average digestibility of an artificial diet (see below) of 55% (protein digestion was 65%, lipid digestion, 25%).

Experiments on *Strongylocentrotus purpuratus* by LASKER and GIESE (1954) provide evidence for the presence of an amylase and a proteinase in the intestine, but none for enzymes capable of digesting entire algae or agar. However, the bacteria isolated from the gut can completely digest the alga *Iridophycus flaccidum* within one week and many of the intestinal bacteria are capable of digesting agar. While it seems likely that the sea-urchin obtains nutritional benefits from its intestinal bacteria, proof for such assumption is lacking (p. 945). The nutritional investigations by NAGAI and KANEKO (1975) revealed that captive *S. pulcherrimus* ingest such foods as white-fish meal, shellfish meal, milk casein, gelatin, soybean meal, yellow corn, alfalfa and yeast provided in the form of a moist, soft material (see also TSUNODA and co-authors, 1970). The test diet was prepared by mixing with agar-agar. The digestibility of the diet and that of the nitrogen contained in it was estimated to be 54.7 and 64.7% dry weight. *S. pulcherrimus* of 10 g fresh weight, cultivated over 5 months on the diet, increased their weight 24% (14° to 20° C; 15 individuals in each 5-l culture enclosure).

Stomach-content analyses of field-collected specimens support the evidence obtained by culturists that echinoids are nutritionally unspecialized and can make use of almost all organic matter which they can get hold of. Digestive tracts of *Brissopsis lyrifera*, *Echinocardium flavescens*, *Schizaster fragilis* and *Spatangus purpureus* contained diatoms, foraminiferans, cnidarians, annelids and remains of molluscs and echinoderms (EICHELBaum, 1910). *Thyone* sp. contained diatoms, algae, protozoans, small worms, crustaceans and other small invertebrates, as well as detritus (COE, 1912). Intestines of freshly collected *Strongylocentrotus purpuratus* were almost always well filled with algae, especially *Macrocystis* sp. (GIESE and co-authors, 1958). Stomach contents of 8 littoral echinoids—*Astropyga radiata*, *Diadema setosum*, *Echinoneus cyclostomus*, *Echinometra mathaei*, *Echinothrix*

calamaris, *Microcyphus rousseaui*, *Stomopneustes variolaris* and *Tripneustes gratilla*—included sea grasses (except *M. rousseaui* and *E. cyclostomus*), green algae, red or brown algae (except *M. rousseaui* and *E. cyclostomus*), corals (except *E. mathaei*), mud and silt (except *E. cyclostomus*), calcareous algae (except *M. rousseaui*), foraminiferans, polyzoans, molluscs and crustaceans (HERRING, 1972). The guts of wild *Strongylocentrotus intermedius* contained numerous plants reflecting the composition of the local flora, as well as animal remains of crustaceans, thecate hydroids and bryozoans (KAWAMURA, 1973); small *S. intermedius* consumed primarily detritus; larger ones, algae (see also KAWAMURA and TAKI, 1965; FUJI, 1967). Further information on stomach or gut contents of echinoids has been presented by ELMHIRST (1922), DAYTON and HESSLER (1972), ATKINSON and co-authors (1973), SUMICH and MCCAULEY (1973) and others. In the mouths of field-collected *Evechinus chloroticus*, DIX (1970) found a large variety of red, brown and green algae, and significant local dietary differences. Local differences in the principal food items consumed have also been reported for *Psammechinus miliaris* (FALLER-FRITSCH and EMSON, unpublished). For details concerning digestion and food absorption consult ANDERSON (1966) and Volume II: PANDIAN (1975).

Ophiuroids are primarily omnivorous ciliary-mucoid filterers, deposit feeders and scavengers. They feed on small organisms and organic particles drifting by, on organic bottom deposits and on a large variety of living and dead plants and animals. In *Ophiocoma scolopendrina*, an ophiuroid inhabiting the subtidal zone, the primary feeding type depends on the water current (tide): in tidal currents it filter-feeds; in quiet waters it picks up particles from the sediment surface; and while the tide is coming in during the daytime, it mops up the surface film while the water is still shallow (MAGNUS, 1963a, 1964). *Ophiocoma nigra* has been shown by FONTAINE (1965) to employ both micro- and macrophagous food-collection. Such diversity and variability convey to the ophiuroid concerned a high degree of versatility and a considerable potential to exploit a large size range of food particles. Small-particle deposit feeding has been reported for *Ophiothrix fragilis* by VEVERS (1956), for *O. spiculata* and *Ophiura lütkeni* by AUSTIN (1964), and for *Amphiura chiajei* by BUCHANAN (1964).

Early juveniles of the West Indian ophiuroid *Ophiolepis elegans* were given *Dunaliella* sp. and *Tetraselmis* sp., but STANCYK (1973) could not ascertain whether they fed on these algae or on the dense populations of protozoans and bacteria which soon developed in his culture dishes. The stomachs of field-collected *Ophiocoma hastatum* contained large amounts of pelagic copepods, e.g. *Calanus finmarchicus*, *C. hyperboreus*, *Euchaeta norvegica* and *Metridia longa* (SCHOENER, 1971).

Growth rates of cultivated echinoderms have been presented, for example, for the asteroid *Pisaster ochraceus* (FEDER and CHRISTENSEN, 1966), and the echinoids *Lytechinus variegatus* (MOORE and co-authors, 1963), *Psammechinus miliaris* (BULL, 1939), *Strongylocentrotus* spp. (SWAN, 1961) and *Hemicentrotus pulcherrimus* (FUJI, 1963). For further details on growth rates in captive echinoderms consult MOORE (1966) and SWAN (1966).

Gamete Maturation and Release

In most of the echinoderms studied, gamete maturation and release is closely

related to seasonal events. While several environmental factors appear to contribute to synchronizing annual breeding activities, light, temperature and nutrition seem to be of major importance. However, detailed information is rare and critical analyses on synchronizing factors are not yet available. The eggs of most echinoderms studied thus far are spherical in shape and measure about 70 to 80 μm in diameter. The spermatozoon has a length of about 45 to 55 μm . It features a pointed conical head, a middle piece with the shape of a flattened cylinder, and a long, thin tail.

Natural breeding

Numerous reports on breeding seasons of crinoids, holothuroids, asteroids, echinoids and ophiuroids have been reviewed and summarized by BOOLOOTIAN (1966b); breeding seasons of European sea-urchins are listed in CZIHAK (1975, p. 41); temperature effects on breeding echinoderms and other marine invertebrates have been considered in Volume I: KINNE (1970). For further information on reproductive cycles in echinoderms consult HYMAN (1955), HARVEY (1956), GIESE (1959), HOLLAND (1967) and PIATIGORSKY (1975).

Ecologically relevant dynamics of gamete maturation and release have received attention especially from GIESE and his associates who concentrated on asteroids and echinoids inhabiting the Pacific coast of the USA. GIESE (1959) has subdivided the reproductive cycle of echinoderms and other marine invertebrates into the following main events: (i) gonad growth and gametogenesis, (ii) gamete release (spawning), (iii) gonad recession, and (iv) sustenance of a resting level (resting period). Most echinoderms breed once a year (e.g. MOORE, 1934; HYMAN, 1955; FARMANFARMAIAN and co-authors, 1958; GREENFIELD and co-authors, 1958; FUJI, 1960; BOOLOOTIAN, 1966a; MOORE and LOPEZ, 1972). Some modes of reproduction and the larval stages typical of echinoderms have been summarized in Table 5-90. A diagrammatic representation of larval types is illustrated in Fig. 5-97. The eggs of most echinoderms are freely released into the surrounding water, and both eggs and larvae are planktonic; exceptions are brooding species and a few species which attach their eggs to the substratum. As in other marine invertebrates, gamete maturation in echinoderms can be inhibited by administering protein-synthesis inhibitors, e.g. fusidic acid and puromycin (ZAMPETTI-BOSSELER and co-authors, 1973).

Spawning in echinoderms may occur preferably at certain times of the day. Many of the species examined spawn primarily at dawn or dusk, a few in the afternoon. An example of the latter case is *Fromia ghardagana* (MORTENSEN, 1938, quoted in HYMAN, 1955), in which the males always spawn prior to the females. A unique situation has been described for *Comanthus japonica*. According to DAN and KUBOTA (1960), this non-stalked crinoid spawns each year on a single afternoon in October at 1500 hrs; the exact date reportedly correlates with the declination of the moon. *Diadema setosum* has been reported to spawn at each full moon during its breeding season in the Red Sea (FOX, 1924a; see also YOSHIDA, 1952). The spawning-inducing stimulus has not yet been pin-pointed—neither in these nor in several other studies which claim lunar periodicity of echinoderm gamete release, but which seem insufficiently documented and, hence, have not been included here.

In some sea-stars, males have been observed to aggregate around mature females prior to spawning. Some species, such as *Archaster typicus*, have been reported to

conduct a 'pseudo-copulation' (BOSCHMA, 1923; OHSHIMA and IKEDA, 1934; CLEMENTE and ANICETE, 1949). The male lies on top of the female with his oral surface pressed against the female's aboral surface, while his arms alternate with hers. Sex ratios and sex-determination mechanisms in echinoderms have been reviewed by BACCI (1965) and DELAVault (1966). Recently, GONOR (1973) proposed that *Strongylocentrotus purpuratus* is a labile gonochorist with a multiple, autosomal, sex-determining mechanism whose expression may be influenced directly by the environment.

Table 5-90
Echinodermata: typical modes of reproduction and larval stages (Original)

Class	Sexual status	Fertilization and development	Brooding	Larval stages
Crinoidea (sea-lilies, feather-stars)	Dioecious. Many gonads situated on proximal pinnules of each arm, except the first pair. Presumably copulation, with the possible exception of viviparous marsupium-bearing genera	Mostly external fertilization	Cold-water species brood their eggs in chambers (marsupium incubation) located in the arms	Doliolaria → cystitea → pentacrinula → metamorphosis. All larvae seen to pass through vitellaria-larva stage (barrel-shaped, armless, with horizontal cilia bands, non-feeding)
Holothuroidea (sea-cucumbers)	Mostly dioecious; few hermaphroditic. One gonad only; this produces ova and spermatozoa simultaneously or is protandric	Mostly external fertilization	Some 30 cold-water species brood their eggs; sometimes coelomic incubation	Dipleurula → auricularia → doliolaria → pentactula → metamorphosis. In 5 species, vitellaria larva; STANLEY (1973)
Asteroidea (sea-stars or starfishes)	Mostly dioecious, a few (e.g. <i>Asterina gibbosa</i>) hermaphroditic	Mostly external fertilization; asexual reproduction; division along central disc and subsequent regeneration	A few cold-water species brood their eggs	Dipleurula → bipinnaria → brachiolaria → metamorphosis
Echinoidea (sea-urchins, heart-urchins, sand dollars)	Dioecious	Mostly external fertilization	A few cold-water species brood their eggs on the peristome, around the periproct or in body cavities	Dipleurula → bipinnaria → pluteus → echinopluteus → metamorphosis. Metamorphosis is rapid and often takes only 1 hr
Ophiuroidea (brittle-stars)	Mostly dioecious. In a few species, females carry dwarf males about; hermaphrodites not uncommon	Mostly external fertilization; asexual reproduction in a few species (e.g. in the genus <i>Ophiactis</i> : disc division, fission and subsequent regeneration	Brooding is common in arctic and antarctic species	Dipleurula → bipinnaria → pluteus → ophiopluteus → metamorphosis

Asexual reproduction is known to occur in asteroids, generally by fission, e.g. splitting of a disc along a line that avoids ossicles and that leaves the arms intact, or by casting off arms which regenerate a complete sea-star (for details consult HYMAN, 1955). Similarly to asteroids, some ophiuroids (e.g. *Ophiactis lymani*, *O. vidarosiensis*, *O. profundis*, *O. viridis*) reproduce asexually. Their disc divides across the middle and each half regenerates to a new individual (FELL, 1966b; see also DELAVault, 1966). In contrast, echinoids, holothuroids and crinoids, while exhibiting considerable capabilities for regeneration, do not seem to reproduce asexually.

Brooding behaviour, i.e. the incubation of eggs and the retention of young within or upon the parent's body, has been reported, especially from cold-water inhabiting echinoderms. The different types of brooding and the concurrent adaptations of

Table 5-91

Brooding behaviour in echinoderms (After BOOLOOTIAN, 1966b; modified; reproduced by permission of Wiley-Interscience)

Class	Genus, species	Structure	Author
Crinoidea	<i>Isometra</i>	Brood chambers located in arms at pinnule bases or in pinnules called marsupium	MORTENSEN (1920) JOHN (1938)
	<i>I. vivipara</i>	Brood chambers in pinnules	MORTENSEN (1920)
	<i>Notocrinus</i>		MORTENSEN (1920) JOHN (1938)
	<i>Phrixometra</i>		JOHN (1938)
Holothuroidea	<i>Bathylplotes natans</i>	Eggs stuck to male tentacles	OHSHIMA (1915)
	<i>Chiridota rotifera</i>	Coelomic incubation	CLARK (1910)
	<i>Cucumaria coatsi</i>	Two incubatory pockets in ventral wall	EKMAN (1925)
	<i>C. crocea</i>	Two incubatory pockets in ventral wall	MACBRIDE and SIMPSON (1908)
	<i>C. curata</i>	Young adhere to smooth part of creeping sole	CLARK (1902)
	<i>C. curata</i>	Young adhere to smooth part of creeping sole	SMITH (1962)
	<i>C. glacialis</i>	Incubatory sacs	MORTENSEN (1894)
	<i>C. glacialis</i>	Incubatory sacs	LUDWIG (1900)
	<i>C. ijimai</i>	Incubatory sacs	OHSHIMA (1915)
	<i>C. joubinii</i>	Deep incubatory pockets	VANEY (1914)
	<i>C. laevigata</i>	Incubatory sacs	LAMPERT (1889)
	<i>C. lamperti</i>	Incubatory sacs	OHSHIMA (1915)
	<i>C. lateralis</i>	Incubatory sacs	VANEY (1907)
	<i>C. parva</i>	Imbedded in sole	LUDWIG (1898)
	<i>C. planci</i>	Eggs retained briefly in tentacular crown	VANEY (1925)
	<i>C. pseudocurata</i>	Young adhere to smooth part of creeping sole	RUTHERFORD (1973)
	<i>C. vaneyi</i>	Incubatory sacs	CHERBONNIER (1949)
	<i>Leptosynapta minuta</i>	Coelomic incubation	BECHER (1906)
	<i>Phyllophorus urna</i>	Coelomic incubation	LUDWIG (1898)
	<i>Pseudocucumis africanus</i>	Coelomic incubation	OHSHIMA (1916)
	<i>Psolidium incubans</i>	Imbedded in the sole	EKMAN (1925)
<i>Psolus antarcticus</i>	Young adhere to smooth part of creeping sole	LUDWIG (1897, 1898)	
<i>P. ephippifer</i>	Held in cavities beneath dorsal scales	THÉEL (1886)	
<i>P. figuratus</i>	Imbedded in the sole	EKMAN (1925)	
<i>P. granulatus</i>	Imbedded in the sole	VANEY (1907)	
<i>P. koehleri</i>	External incubatory pockets	VANEY (1914)	

Table 5-91—Continued

Class	Genus, species	Structure	Author
	<i>P. punctatus</i>	Imbedded in the sole	EKMAN (1925)
	<i>Synaptula hydriformis</i>	Coelomic incubation	CLARK (1898)
	<i>Taeniogyrus contortus</i>	Incubatory sacs in the ovaries	LUDWIG (1887, 1898)
	<i>Thyone imbricata</i>	Incubatory sacs	OHSHIMA (1915)
	<i>T. rubra</i>	Coelomic incubation	CLARK (1901)
	<i>Thyonepsolus nutriens</i>	In pockets in the back body surface	CLARK (1901)
	<i>T. nutriens</i>	In pockets in the back body surface	WOOTTON (1949)
	<i>Trochodota dunedinensis</i>	Coelomic incubation	JOHN (1939)
Asteroidea	<i>Anasterias</i>	Under the disc	FISHER (1940)
	<i>A. antarctica</i>	Beneath the disc	PHILLIPPI (1870)
	<i>A. antarctica</i>	Beneath the disc	PERRIER (1891)
	<i>A. studeri</i>	Beneath the disc	SMITH (1876, 1879)
	<i>Cryptasterias</i>	Under the disc	FISHER (1940)
	<i>Ctenodiscus australis</i>	Eggs lodge among paxillae	LIEBERKIND (1926)
	<i>Diplasterias</i>	Under the disc	FISHER (1940)
	<i>D. brandti</i> (= <i>Lütkeni</i>)	Beneath the disc	SMITH (1876, 1879)
	<i>D. brucei</i>	Under the disc	FISHER (1940)
	<i>D. meridionalis</i>	Under the disc	FISHER (1940)
	<i>D. octoradiata</i>	Under the disc	FISHER (1940)
	<i>Granaster</i>	Under the disc	FISHER (1940)
	<i>G. nutrix</i>	Young develop in pouches of cardiac stomach	STUDER (1885)
	<i>Henricia sanguinolenta</i>	Beneath the disc	SARS (1844, 1846)
	<i>Kamplaster</i>	Under the disc	FISHER (1940)
	<i>Leptasterias arctica</i>	Attached by a strand to one of several central soft masses	FISHER (1930)
	<i>L. groenlandica</i>	Young develop in pouches of cardiac stomach	LIEBERKIND (1920)
	<i>L. hexactis</i>	Brood chamber formed by arching disc	VERRILL (1914) OSTERUD (1918) CHIA (1966) MENGE (1975)
	<i>L. hexactis</i>	Under the disc	FISHER (1930)
	<i>L. mülleri</i>	Beneath the disc	SARS (1844, 1846)
	<i>L. ochotensis</i>	Carried beneath in peristome of forcipulates	KUBO (1951)
	<i>L. pusilla</i>	Carried in the oral cavity of actinal surface	FISHER (1930)
	<i>Leptychaster alumus</i>	Eggs lodge among paxillae	FISHER (1917)
	<i>L. kerguelenensis</i>	Eggs lodge among paxillae	THOMSON (1877, 1878)

Table 5-91—Continued

Class	Genus, species	Structure	Author
	<i>L. uber</i>	Eggs lodge among paxillae	DJAKONOV (1926)
	<i>Lyasterias</i>	Under the disc	FISHER (1940)
	<i>L. belgicae</i>	Beneath the disc	LUDWIG (1903)
	<i>L. chirophora</i>	Beneath the disc	LUDWIG (1903)
	<i>L. perrieri</i>	Beneath the disc	SMITH (1876, 1879)
	<i>Neosmilaster</i>	Under the disc	FISHER (1940)
	<i>Odinella nutrix</i>	Eggs lodge among paxillae	FISHER (1940)
	<i>Pteraster</i>	In nidamental chamber	KOREN AND DANIELSSEN (1857)
	<i>Rhopiella</i>	Under the disc	FISHER (1940)
Echinoidea	<i>Anochanus sinensis</i>	Unsunken aboral centre is brood pouch	GRUBE (1868)
	<i>Aporocidaris milleri</i>	Peristomial brooding	MORTENSEN (1927b)
	<i>Austrocidaris canaliculata</i>	On the peristome around the periproct	THOMSON (1878)
	<i>Ctenocidaris geliberti</i>	Around sunken edge of peristome	MORTENSEN (1950)
	<i>C. nutrix</i>	On the peristome around the periproct	THOMSON (1878)
	<i>C. perrieri</i>	Peristomial brooding	MORTENSEN (1950)
	<i>C. spinosa</i>	Peristomial brooding	KOEHLER (1926)
	<i>Goniocidaris umbraculum</i>	Peristomial brooding	MORTENSEN (1925)
	<i>Hypsiechinus coronatus</i>	On the apical system of plates in an elevated periproct of females	MORTENSEN (1903)
	<i>Notocidaris gaussensis</i>	On the peristome	MORTENSEN (1909)
	<i>Plexechinus nordenskjöldi</i>	In deeply insunken aboral centre	MORTENSEN (1950)
	<i>Rhynchocidaris triplopora</i>	Lodged in a circular depression on the peristome	MORTENSEN (1909)
	<i>Tropholampas loveni</i>	Unsunken aboral centre is brood pouch	CLARK (1923)
Ophiuroidea	<i>Amphipholis squamata</i>	Bursal brooding	QUATREFAGES (1842)
	<i>A. squamata</i>	On stalk put out by bursa	MACBRIDE (1892)
	<i>A. squamata</i>	On stalk put out by bursa	FELL (1941)
	<i>Amphiura stimpsonii</i>	In bursae	MORTENSEN (1921)
	<i>Astrocllamys bruneus</i>	In bursae	MORTENSEN (1936)
	<i>Ophioplocus esmarki</i>	In bursae	RICKETTS and CALVIN (1939)
	<i>Stegophiura sculpta</i>	In bursae	MURAKAMI (1941)

both adults and young have been reviewed by BOOLOOTIAN (1966b; for details consult Table 5-91). Brooding beneath the disc was discovered by SARS (1844, 1846) in *Henricia sanguinolenta* and *Leptasterias mülleri*, two cold-water species of northern Europe. In most brooding sea-stars, the mother bends her arms ventrally thus forming a protected space surrounded by her concave oral disc and her arm bases. In this space, egg incubation, hatching and early postembryonal development proceed to the stage of tiny sea-stars. In some cases, the young sea-stars developing from the compact egg masses remain attached for some time, at their mouth region, to a common tissue strand (LUDWIG, 1903), or seem to be attached to the mother. In *L. arctica*, FISHER (1930) found each baby star to be attached by a strand to one of several soft central masses. The degree of physiological relationship, if any, between mother and young remains to be analyzed. Brooding occurs in all 5 classes (Tables 5-90, 5-91); viviparity has been reported or claimed for a few echinoderms only (e.g. GRUBE, 1868; JOHN, 1939). The asteroids *Asterina exigna*, *A. gibbosa* and *Leptasterias ochotensis* attach their eggs to solid substrata, e.g. the subsurface of stones. The large (0.5 to 1 mm diameter), yolky eggs adhere firmly with their sticky outer membranes.

In general, brooding echinoderms produce far fewer but larger eggs than their non-brooding counterparts. Brooding *Leptasterias ochotensis*, for example, carry 100 to 800 eggs (KUBO, 1951), and *L. hexactis* up to 1160 eggs (OSTERUD, 1918). The number of baby stars produced per brood may range from 10 to 200, in exceptional cases to 500 or more. In contrast, the non-brooding *Asterias rubens* produces 2 or 3 million eggs in a 2-hr spawning period and spawns more than once during one breeding season (GEMMILL, 1914); *Luidia ciliaris* carries about 200 million eggs in its ovaries (MORTENSEN, 1913). Brooding in echinoderms has been suggested to be a coadaptive consequence of competition-induced small body size (MENGE, 1975), assuming that a small broadcasting species cannot produce enough offspring in its normal life span to maintain population size.

Artificially induced breeding

In order to obtain echinoderm eggs and spermatozoa for experimentation or as food for other cultivated animals, the simplest method is gonad removal. The ripe, excised gonad is allowed to shed into a dish of sea water. For fertilization, only a small fraction of the male gonad needs to be excised. Gonad removal must be performed carefully so as to avoid excessive contamination from cellular debris; it causes heavy injury (e.g. arm amputation in asteroids)* or the immediate death of the donor, and is not suitable for large-scale spawning induction. Hence, investigators interested in avoiding heavy damage, in the repeated use of a given individual, or in the spawning of large experimental populations must resort to artificially induced breeding.

Artificial induction of gamete release in echinoderms has been obtained by methods similar to those employed in molluscs (pp. 898, 925) and fishes (pp. 1028). As in many other animals, the strength and the specificity of the stimulus required

* FUSELER (1973) has described a method which permits repetitive procurement of gametes from a single *Asterias forbesi*: a ripe female is repeatedly induced to autotomize a single arm (which contains 2 ovaries).

tends to decrease as a function of gonad maturity and time (Fig. 5-98). Finally, spawning may be spontaneous. The stimuli known to induce spawning in ripe echinoderms may be grouped into biological, thermal, osmotic, electrical, mechanical, chemical or radiant.

The efficiency of the different stimulation techniques varies with the species and the degree of maturity of the individual concerned. Within the same species and in individuals of equal gonad maturity, the reliability of artificial gamete-release induction is a function of stimulus strength and type. For many purposes, chemical methods (KCl injection) turned out to be most convenient and produced the most consistent results.

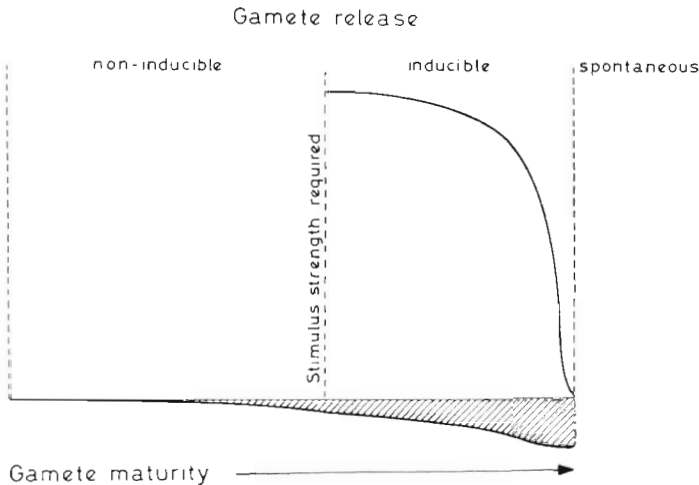

Fig. 5-98: Gamete-release induction as a function of gamete maturity. Theoretical model. Based on information quoted in the text. (Original.)

Biological stimuli include the addition to the culture water of gametes or of homogenates of ripe conspecifics or of closely related species and of nerve extracts. Spawning following the addition of ripe gametes to the culture water or of sea water containing ripe eggs or spermatozoa has been reported, for example, for *Asterias rubens* (GEMMILL, 1914), *Paracentrotus lividus* (FOX, 1924b) and *Arbacia punctulata* (PALMER, 1937); in the latter case, however, undamaged gametes failed to induce gamete release. PALMER obtained spawning in *A. punctulata* also after adding homogenates of ripe conspecifics or of closely related echinoderms, and reports comparable success after applying ground fish or frog muscle directly to the gonads. Nerve-extract-induced gamete release has received much attention since CHAET and McCONNAUGHY (1959) reported that the injection of radial-nerve extract into the perivisceral coelome of ripe conspecifics or close relatives induces prompt gamete release. Because of its reliability, this method proved to be of considerable practical importance for experimentation with echinoderm gametes and for making eggs available as food for other cultivated marine animals.

The factor held responsible for radial-nerve-induced gamete release—the ‘shedding substance’—is a ‘neurohormone-like’ material—presumably a polypeptide of 10 to 15 amino acids, originating in neurosecretory cells. It has been recovered from

the radial nerves of males and females of some 18 species of sea-stars (CHAET and ROSE, 1961; HARTMAN and CHAET, 1962; KANATANI and NOUMURA, 1962; NOUMURA and KANATANI, 1962; UNGER, 1962; CHAET, 1964b, c, 1966, 1967; CHAET and co-authors, 1964; KANATANI, 1964). Both male and female recipients respond to nerve extracts from either sex.

The shedding substance can be released by heating a suspension of nerves in sea water or by lysing with distilled water. From 3.4 g of dried *Patiria miniata* nerves, 1.3 mg purified shedding substance could be isolated. An injection of a 5 to 10 mg% nerve-extract-sea-water solution, prepared from isolated, lyophilized radial nerve, into the perivisceral coelome of a ripe sea-star (0.15 ml g⁻¹ of sea-star) induces the release of mature gametes (CHAET and MUSICK, 1960; CHAET, 1964a). Following the injection, ova or spermatozoa appear at the gonopore openings after a characteristic delay of 30 to 35 mins; virtually all of the fully grown eggs are shed and the gametes released are highly fertile. Apparently, the nerve extract is acting via a first order endocrine reaction and the lag period depends on the ovary itself, but on no other anatomical structure of the individual concerned (CHAET, 1967).

The shedding substance stimulates ovarian contraction (CHAET and co-authors, 1964) and induces eggs to complete their maturation (CHAET, 1964c). It 'dissolves' the extracellular material which holds the egg mass together in an unstimulated ovary (KANATANI, 1964). Purification and analysis for amino acids of the shedding substance obtained from *Patiria miniata* gave the following results: (i) the shedding substance constituted at least 0.04% of the original weight of the dried nerve; (ii) purification increased the specific activity about 383-fold; (iii) 17 amino acids were found; the shedding substance apparently contained a minimum of some 42 amino-acid moieties, implying a minimum molecular weight of around 4800 (CHAET, 1967).

Since the level of shedding substance remains constant over a year, the disappearance of an inhibitor substance ('shedhibin')—which begins to build up just before the sea-star is going to spawn and which appears to prevent or delay spontaneous shedding—seems to regulate spawning (CHAET, 1967). In nature, the shedding substance is assumed to induce natural breeding after release into the surrounding water (synchronization of population breeding). It remains to be demonstrated, however, that the shedding substance acts specifically as gamete releaser. Detailed analyses of the physiological mechanism involved make sense only after unequivocal demonstration of such action specificity.

Biologically-induced spawning inhibition, due to an anti-meiotic effect of ovary extract, has been established for *Asterias amurensis* (IKEGAMI and TAMURA, 1973). The active principle was isolated, purified and identified as asterosaponins A and B. At doses of 5 to 20 mg dry tissue ml⁻¹, sea-water-ovary extract caused significant inhibition.

Thermal induction of gamete release has been demonstrated in several species. A well-known example is *Asterias forbesi*. In this sea-star, a rapid increase in culture temperature causes spawning (GALTSOFF and LOOSANOFF, 1939). A sudden temperature rise of a few degrees centigrade is sufficient. Once gamete release has been initiated in 1 or 2 individuals, the free gametes act as additional biological stimulus. In the holothurian *Thyone briareus*, temperature increase of some 5 °C for about 5

hrs induced spawning (COLWIN, 1948). MORTENSEN (1938) reported thermal spawning induction in ophiuroids.

A combination of light and temperature shocks has induced spawning in the ophiuroid *Ophiolepis elegans* (STANCYK, 1973). Freshly collected ripe individuals were exposed during transportation to the laboratory to increased temperatures (32° to 34° C) and, upon arrival in the laboratory, placed in fresh, aerated sea water of about 24° C. After a period of 1 to 5 hrs in dim light, ripe females were exposed to bright light. They began to spawn within 10 mins; subsequently, the males also released their gametes. The combined method yielded consistent results in *O. elegans*, but failed to induce spawning in *Ophiothrix angulata* and *Ophriophragmus filograneus*.

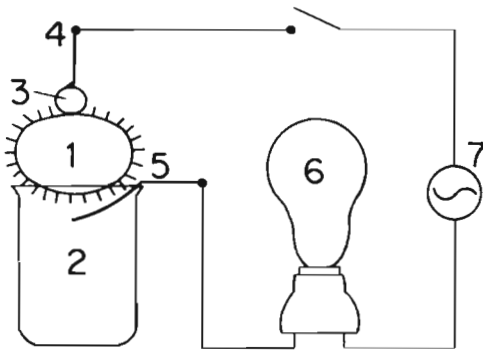

Fig. 5-99: Electrically induced spawning in a sea-urchin. 1: Sea-urchin; 2: beaker filled with sea water; 3: sea-water-moistened cotton wool; 4 and 5: electrodes; 6: 40- to 100-W lamp; 7: 100-V electrical power source (50 or 60 cps). (After IWATA, 1962; modified; reproduced by permission of Zoological Society of Japan.)

Osmotically induced gamete release has been observed in ripe *Asterias rubens* (KINNE, unpublished). A total of 29 individuals, kept under normal light conditions near a window in a basement culture room at 18° C (150-l tank; food: *Mytilus edulis*) began to spawn after a sudden reduction in salinity from about 35‰ to 25‰ S. More than 80% of the eggs turned out to be fertilized and larvae hatched from several thousand fertilized eggs incubated in a separate aquarium.

Electrical induction of gamete release is a particularly convenient method for obtaining echinoid eggs and spermatozoa (IWATA, 1950, 1962; HARVEY, 1956). Electrodes (alternating current, 10 to 20 V) are placed on the shell at any two points. After a short time, gamete release begins, and usually ceases when the current is interrupted. In this way, small amounts of sexual products can be obtained repeatedly from the same individual. However, repeated electrical stimulation may critically injure the sea-urchin (delayed death). Injury at the point of electrode contact seems unavoidable. In cases where long-term survival of the donor is required, electrical stimulation must be replaced by a less injurious method, e.g. KCl injection (see below).

An arrangement for electrical induction of spawning is shown in Fig. 5-99. Mouth upward, the sea-urchin is placed on top of a sea-water filled beaker. Since air exposure, even for only a few minutes, may cause lethal damage in several urchins, a different arrangement is required where reuse of the treated individual is intended. For such a case, HINEGARDNER (1975) recommends placing beaker and urchin in a second, larger beaker with the water level just covering the urchin. In well-fed individuals, gamete release can be induced again after about 1 month.

Mechanically induced gamete release has been obtained in several ripe echinoderms, e.g. after rough handling or transportation. *Arbacia punctulata* spawned after a cut was made around the peristome or the ambitus (PALMER, 1937). When the treated individual was placed oral side up in a sea-water-filled culture dish, gamete release commenced immediately, but not if placed oral side down, unless very severely injured. PALMER assumes that gamete release is caused by a substance set free after the operation and that this substance can reach the gonads more readily if the aboral side points downward. BERNHARD (1955) induced *A. lixula* to spawn by cutting mature specimens open along the oral membrane, placing them oral side up in a Boveri dish and carefully massaging their gonads. In *Patiria miniata*, handling and brief removal from the water may have caused subsequent gamete release (NEWMAN, 1925).

Chemically induced spawning has been obtained in several asteroids and echinoids. In the echinoid *Arbacia punctulata*, PALMER (1937) injected isotonic KCl through slits in the peristome, or applied this salt solution directly to the gonad in freshly opened individuals. According to HARVEY (1956) and METZ (1956), in *Arbacia* species, a fertilization inhibitor, presumably released from the epidermis or from extruded perivisceral fluid, may significantly reduce egg fertility or render the eggs unfertilizable. Avoidance of injury to the epidermis and washing of KCl-shed eggs eliminates such fertilization problems. In *Lytechinus pictus* and related sea-urchins and sand dollars, KCl injections (ca 0.5 M) with a fine hypodermic needle have yielded consistent success (TYLER, 1949) and may be considered a non-injurious method, repeatable at intervals of a few days, for months or even years. The hypodermic needle (ca 24-gauge) is forced through the peristome membrane and aimed at the middle of the side where the gonads lie between the rows of tube feet. The exact amount of KCl injected depends on the volume of the sea-urchin treated and on the amount of gametes required. If 0.1 to 0.2 ml is carefully injected near one of the gonads, it is often possible to induce gamete release in that gonad only. The other gonads can then be stimulated as required. Larger amounts of KCl injected at several points cause complete spawning (HINEGARDNER, 1975).

In *Lytechinus variegatus*, FUSELER (1973) induced gamete release by injecting KCl through the peristomial membrane at its immediate junction with 1 of the 5 rows of ambulacral plates. Ripe eggs yielding fertilization rates of 98 to 100% could be obtained this way routinely 3 times a day with a 3- to 4-hr period between successive spawnings and for up to 7 days from a single ripe female.

Gamete release usually begins within a few seconds after injection and continues over some 5 to 15 mins. As has already been pointed out, the volume of the KCl solution injected is a function of recipient size—usually 0.5 ml suffice to induce the complete release of ripe gametes in a sea-urchin of about 50 ml displacement volume. Generally, only ripe gametes are released, but when overstimulated, a small

percentage of eggs in the germinal-vesicle stage may be shed—usually towards the end of the spawning period (TYLER and TYLER, 1966a, b).

Eggs can be conveniently collected by placing the female upside down on a beaker completely filled with sea water so that the gonopores are submersed. Males are usually allowed to release their sperm into a dry dish. In this way, premature activity loss of spermatozoa is avoided or reduced.

Japanese investigators often employ a sacrifice-KCl method. They remove Aristotle's lantern by cutting around the peristomial membrane with scissors, place the sea-urchin upside down on a 20- to 30-ml beaker filled with sea water, remove most of the body fluid, and pour a 0.5 M KCl solution (pH 8) into the body cavity. This method yields a large number of gametes, but, of course, kills the urchin. The gametes aggregate on the bottom of the beaker. Prior to fertilization, the eggs are washed several times in pure sea water (IIDA, 1942; OSANAI, 1975).

Calcium injection (isotonic CaCl_2 solution) through the peristomial slits of the echinoid *Arbacia punctulata* (PALMER, 1937) or the asteroid *Patiria miniata* (MECKLENBURG and CHAET, 1964) also induces the release of ripe gametes. Presumably, calcium injection affects gonad muscle contraction so that the sexual products are pressed out. Such muscle contraction has been observed by PALMER also after administering extracts of injured tissue directly to the gonad surface.

In *Lytechinus pictus*, HINEGARDNER (1969) obtained better urchin survival after inducing gamete release by injection of acetylcholine (IWATA and FUKASE, 1964) or one of its analogues. A 0.01 M solution made up in sea water immediately (10 to 20 mins) before application works well (HINEGARDNER, 1975). Injected in the same way as KCl, acetylcholine does not seem to harm gametes or urchin.

Radiant energy, i.e. changes in the quantity of illumination, has been held responsible for inducing spawning in several ripe echinoderms, e.g. in ophiuroids (COSTELLO and co-authors, 1957).

(d) Echinodermata as Assay and Food Organisms

Echinoderm larvae, especially those of sea-urchins, may serve as convenient assay organisms because (i) they are easily obtainable and convenient to handle; (ii) their functions and structures are well investigated; (iii) a large variety of criteria can be used as end points to be measured; (iv) many larvae are easy to cultivate, but respond sensitively to changes in water quality; (v) early larvae require no external food.

Already WILSON (1951) and WILSON and ARMSTRONG (1952) have used larvae of the sea-urchin *Echinus esculentus* for assessing differences in the capacity of sea-water samples to sustain life. BERNHARD (1955) used developing eggs of the sea-urchin *Arbacia lixula* for assaying sea-water quality (for details see p. 1493). From his experiments, BERNHARD concluded that the inhibition of larval development in natural sea water was due to excessive amounts of heavy metals. Detergent effects on unsegmented sea-urchin eggs have been studied by LALLIER (1973).

Holothurian longitudinal muscles have been used for assay of acetylcholine (e.g. BACQ, 1939). MOUSSATCHÉ (1949) and MOUSSATCHÉ and ARONSON (1951) have shown that muscles of *Holothuria grisea* respond (contract) even to very low

acetylcholine concentrations (see also AMBACHE and SAWAYA, 1953; WELSH, 1954; SAWAYA and ANCONA LOPEZ, 1959; SAWAYA, 1962).

In adult asteroids—mostly species of *Asterias*—responses related to food uptake (e.g. locomotion, search and avoidance reactions, stomach eversion) have been studied by several investigators. The sea-stars were exposed to different concentrations and gradients of dissolved substances such as amino acids, prey-tissue extracts, intact prey, bacteriological peptone, urea, lactic acid and 'hand sweat'. Early investigations stimulated by LOOSANOFF and SHIPLEY (1947) have been reviewed by FEDER and CHRISTENSEN (1966). Most of the early studies, as well as those conducted by BRAUER and JORDAN (1970), CASTILLA and CRISP (1970), WHITTLE and BLUMER (1970a, b) and ZAFIRIOU and co-authors (1972), demonstrate appreciable chemoreceptive capacities. *A. rubens* seems to be uniquely sensitive to glutamic acid (CASTILLA, 1972). In principle, the responses investigated could be, and in fact have been, used (e.g. by ZAFIRIOU, 1972) for bioassay purposes. However, the type and degree of the responses may be subject to change during the year—apparently due to variations in temperature and other environmental factors, and/or to seasonal sensitivity changes in sea-stars.

Several of the results obtained are ambiguous and reveal contradictions which remain to be resolved. Hence, further work on asteroid responses to chemical stimuli is required before reliable assay techniques can be worked out.

Eggs and larvae of echinoderms, especially of asteroids and echinoids, have been used as food for other cultivated animals, notably gastropods, malacostracans and fishes. Juvenile and adult echinoderms are consumed by only a few nutritional specialists. Hence, they are considerably less important as food organisms.

(e) Echinodermata: Conclusions

Most echinoderms sustained in cultures belong to the classes Asterozoa and Echinozoa. Holothurozoa have been kept in many public sea-water aquaria, but detailed information on their environmental and nutritional requirements is not available. Several holothurozoa are presently examined for their mariculture potential. Many Ophiurozoa are apparently as easy to keep in captivity as are asteroids, but brittle-stars have received less attention from experimental ecologists. Crinozoa appear to be the most difficult echinoderm group to sustain under controlled conditions. While some crinoids have survived in public aquaria, it seems difficult to provide these suspension- and deposit-feeding echinoderms with adequate nutrients in small-scale culture systems. As in the Porifera (p. 627), the administration of small particulate food items of proper quality, size range and concentration remains problematic.

The most critical life-cycle phase in cultivated asteroids, echinoids and ophiuroids usually begins with metamorphosis and ends when the young sea-star, sea-urchin or brittle-star begins to feed and grow appreciably. In subadults and adults, mortality usually decreases drastically. The high mortalities during and immediately after metamorphosis seem to be related to the complex and dramatic changes in body functions and structures. In echinoderms, these changes are more pronounced than in most other marine invertebrates.

The essentials of echinoderm cultivation may be summarized as follows: (i)

use healthy parents and only ripe eggs and active spermatozoa; (ii) inseminate eggs as soon as possible after gamete release; (iii) use the smallest quantity of sperm necessary for obtaining a sufficiently high fertilization percentage (too many spermatozoa cause polyspermy and reduce the survival chances of developing eggs); (iv) use filtered, sterilized sea water and sterilize all materials (e.g. culture enclosure, instruments) before use; (v) avoid the introduction of foreign organisms, especially disease agents; (vi) clean the fertilized eggs carefully (removal of debris and excess sperm); (vii) pipette the newly hatched larvae, as soon as they swim up, into freshly prepared containers; (viii) select food organisms (unicellular algae) small enough to be taken up by the larvae and make sure the food is well distributed in the culture water; (ix) when the larvae begin to feed intensively, provide a rather high food concentration; reduce the daily food allowance later and control optimum algal density, e.g. by partial water exchange (identical quality!) and/or by illumination (algal population growth); (x) change the type of food organisms according to species-specific requirements, especially after metamorphosis and for the growing juvenile; (xi) for larval settlement, provide a proper substratum covered by a metamorphosis-inducing microbial film; (xii) maintain slow water movement and gentle aeration, or use culture enclosures with a large water surface-to-volume ratio; (xiii) do not expose the cultures to direct sunlight or high artificial illuminance; (xiv) avoid rapid changes in temperature, salinity and other environmental factors.

Most culture experiments conducted on echinoderms concentrated on the early ontogenetic development in echinoids, especially sea-urchins. The eggs and larvae of sea-urchins have received more attention from physiologists, biochemists and morphologists than those of any other marine invertebrate. The essential aspects of our present knowledge on gametogenesis, fertilization, embryology, metamorphosis, cytology and cytochemistry have been discovered and investigated in sea-urchins. The major reasons for this are (i) sea-urchin gametes are readily available in large amounts; (ii) fertilization, incubation and hatching constitute no problems; (iii) eggs and larvae are transparent, facilitate surgical operation and have an extraordinarily high healing and regeneration capacity; (iv) the larvae grow for appreciable periods of time even if not fed.

The abundance of physiological and embryological papers contrasts sharply with the scarcity of ecologically oriented culture experiments. While it is easy to incubate echinoid eggs and to rear the larvae, it is difficult to sustain these beyond metamorphosis under controlled conditions. The cultivation of juvenile and adult asteroids and echinoids is often unproblematic.

Echinoderms display an impressive array of feeding mechanisms and have succeeded in making use of practically all potential food items which they can seize in terms of size, rigidity and motility. While particulate matter probably constitutes the major food source for most echinoderms, the uptake of dissolved organic substances appears to play a nutritional role, at least in some species.

Most echinoderms entertain intimate relationships with, and display direct dependence upon, the substratum. Hence, for the culturist the provision of an acceptable substrate ranges high in long-term research cultivation and in all attempts of egg-to-egg breeding. Water movement and the provision of adequate small particulate food items are of paramount importance for all echinoderm suspension feeders, especially crinoids.

(13) Pisces

(a) General Aspects

More than 70% of the papers written on fish cultivation are devoted to fresh-water forms. Of the studies dealing with marine fishes, about 80% are primarily or exclusively concerned with commercial cultivation (mariculture). From such applied research, the general field of marine fish cultivation has received major impulses. Much important information that has become available in the last 5 decades is based on investigations conducted in order to explore the prerequisites for successful fish farming. Hence, the present status of marine fish cultivation can be reviewed adequately only by taking into account the results obtained on commercially important species. However, this section emphasizes aspects of research cultivation; the essentials of commercial cultivation are briefly summarized in Chapter 5.2.

Methodologically, the cultivation of marine fishes is based on the principles of water-quality management and technology reviewed in Chapter 2. In fact, most sea-water systems have been developed with reference to fishes. For this reason and because the literature concerned with methodological aspects of fish cultivation is highly repetitive, we restrict ourselves here to reviewing and evaluating the information available by referring to a few examples. A full inventory is neither possible nor does it seem useful. Many of the marine and brackish-water fishes sustained in culture are listed in Tables 5-137, 5-141, 5-142 and 5-146.

Important early contributions to the field of marine fish cultivation have been presented by HERTLING (1932), ROLLEFSEN (1939), MORRIS (1956), ATZ (1964) and SHELBORNE (1964). Reviews on commercial fish cultivation are listed in Chapter 5.2, p. 1323. A book edited by HALVER (1972a) reviews important aspects of fish nutrition. The transformation of organic matter by fishes has received attention in Volume IV: CONOVER (in press).

(b) Rearing of Larvae

Larvae of marine fishes are difficult to rear. Next to breeding, the raising of larvae constitutes the main stumbling block for experimental ecologists and mariculturists. Many larvae refuse to feed and exhibit narrow, specific environmental and nutritive requirements. These must be met immediately because the tolerance of larvae to prolonged environmental stress or to starvation is lower than that of any other life-cycle stage (see also p. 987). At the same time, the capacity for individual adjustments (non-genetic adaptation; Volume I: KINNE, 1970, 1971) generally tends to attain minimum values in eggs and early larvae. A bibliography of attempts to rear larvae of marine fishes has been compiled by MAY (1972).

Fertilization, Incubation and Hatching

Eggs and spermatozoa are usually obtained from newly caught, ripe spawners—either by stripping, or by dissection. In a few cases, fertilized eggs have been collected in the field—either separated from water samples (planktonic eggs) or removed

from substrata (demersal eggs). Very few marine fishes have spawned naturally in captivity (p. 1021); some have been artificially induced to spawn (p. 1023).

The stripping procedure used for inseminating marine fish eggs is similar to that long established for freshwater fishes. Three types of stripping may be distinguished: the wet, dry and semi-dry method. The wet method involves stripping of ripe spawners into a pan half filled with (filtered and/or sterilized) sea water; the dry method, stripping without added sea water; the semi-dry method, stripping of males into sea water (sperm activation prior to insemination) and of females without added sea water. The wet method is often less efficient than the dry method or the semi-dry method. In the dry method, the eggs become coated with a film of milt, and fertilization proceeds immediately upon adding sea water.

Without any sea water, eggs and spermatozoa may retain their fertilizability for hours or days, especially at low temperatures. Recent experiments with *Clupea harengus*, *Pleuronectes platessa* and *Belone belone* have also demonstrated positive effects of oxygen treatment: when placed in O₂-filled plastic bags, dissected, mature gonads yielded eggs with above 80% fertilizability for up to 6 hrs (ROSENTHAL, personal communication). However, even without added oxygen, BLAXTER (personal communication) regularly obtained 95–100% fertilization after storing herring gonads dry for 12 to 24 hrs.

Essentials of the dry method may be summarized as follows: (i) Select healthy, fully mature spawners and strip females and males as soon as possible after the catch; alternatively, keep the spawners alive in a suitable tank, store the dead fish at a low temperature, or remove gonads and place in O₂-filled plastic bags. (ii) Spawners and fertilization pan must be clean and carefully wiped dry. (iii) Hold the spawner in an inclined position with its head pointing upwards; one hand grasps its head (if necessary, use a soft towel), the other its back. (iv) Move the latter hand slowly downwards towards the genital opening, with thumb and index finger delicately pressing the abdomen; in ripe spawners, this readily releases eggs or milt. (v) After stripping the females, milt is distributed over the eggs and both are mixed well. Now sea water is added and the mixing repeated. The mixture should stand for up to 30 mins. Then the eggs are washed clean with filtered, if necessary sterilized sea water in order to remove debris, excess sperm and other contaminants. Many spawners survive stripping, provided it is executed with care.

For incubation, suitable portions of fertilized, washed eggs are transferred into incubators (Fig. 5–100a-f). Some investigators have developed special equipment such as the serial trout incubator (Fig. 5–100b), the flow-through incubator (Fig. 5–100e) or the water-bath-surrounded incubators for incubating demersal eggs (Fig. 5–100f). In the latter case, the water in the 300-cm³ glass enclosures was renewed daily using water previously adjusted to the same temperature (containers 3 and 4). For studying effects of environmental factors on incubated marine fish eggs, ALDERDICE and VELSEN (1968) designed incubators, each holding 4 sub-samples of eggs, which can be perfused with water of controlled characteristics at a known flow rate. A ship-board incubator for pelagic fish eggs described by KUNITSYN (1968) features spherical containers suspended on universal joints with shock absorbers, which dampen the ship's vibrations and movements. Floating trays (Chapter 2, p. 241) have also proved useful as incubators for developing fish eggs.

For egg incubation, unpolluted, filtered and sterilized sea water must be used and

sufficient aeration, water movement and/or water change be provided. Adequate gas exchange between egg and ambient water is essential (e.g. DAYKIN, 1965). In many cases, dim light or darkness has produced better results than high illuminance. Microbial infection and parasitic infestation can be counteracted by cleanliness, sterilization of equipment, removal of 'sick' eggs and, if necessary, application of antibiotics (p. 997). According to BLAXTER (personal communication), many fish eggs are very susceptible to vibration before gastrulation and should not be moved; eyed ova of salmonids, on the other hand, are extremely resistant to mechanical and other stresses.

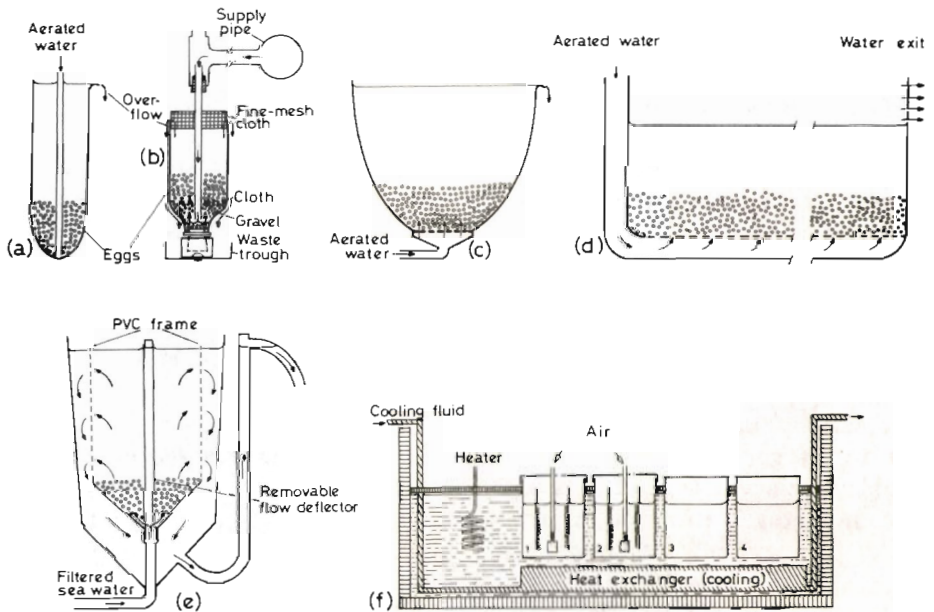

Fig. 5-100: Incubators used for fish eggs. Some general designs (a, c, d) and specific equipment. (b: After BUSS and WAITE, undated; modified; reproduced by permission of the authors; e: after GIRIN, in press; modified; reproduced by permission of the author; f: after VON WESTERNHAGEN, unpublished.)

Incubation conditions are better controllable in demersal eggs (e.g. egg density and distribution; water-flow rate relative to egg surface) than for planktonic eggs. The demersal eggs of the herring *Clupea harengus*, for example, can be spread out evenly in one layer on a glass plate (minimum interference of surface-exchange processes) and handled conveniently for transfer, examination or experimentation.

While the basic prerequisite for hatching is the completion of embryo development to a certain stage, additional stimuli affect, or may be required for, hatching—such as changes in illumination, temperature or oxygen partial pressure (e.g. JOHANSEN and KROGH, 1914; TRIFONOVA, 1937; MILKMAN, 1954; ALDERICE and co-authors, 1958; BUZNIKOV, 1957; GARSIDE, 1959, 1960; HAMDORF, 1961; KINNE and KINNE, 1962). In *Salmo irideus*, hatching size depends directly on the ambient O_2 partial pressure (HAMDORF). A decrease in O_2 partial pressure of the perivitelline fluid initiates the secretion of the hatching enzyme hyaluronidase (BUZNIKOV).

Experiments on fertilization, incubation and hatching of marine fish eggs have contributed essentially to our present knowledge on (i) the effects of environmental factors on rates of early development, metabolism and growth, and on meristic characters, e.g. number of myotomes, vertebrae or fin rays (Volume I: GARSIDE, 1970); and (ii) fish taxonomy, especially the establishment of identification keys for eggs and larvae. The processes of fertilization, incubation and hatching have also been used increasingly for quick assessment of the biological consequences of water pollution (p. 1032; Volume V).

Controlled fertilization, incubation and hatching are of significance for providing seedlings for commercial fish farmers. However, the importance of hatcheries for wild-population recruitment has been very limited (see also Chapter 5.2, p. 1327). Hatcheries established in North America and Europe have produced billions of larvae, e.g. of cod, haddock and plaice, and released them every year, for periods of up to a decade, into selected sea areas. However, with the exception of salmon, none of the restocking programmes has measurably affected size and catchability of commercial fish stocks. Hence, practically all hatcheries have been closed down.

Critical Period

The reproductive biology of many marine fishes is characterized by high fecundity and high larval mortality. This fact and the assumption that the high larval mortalities can be correlated to specific causes such as nutrition, environmental factors, predation or developmental characteristics has led to a hypothesis known as 'critical period concept'. Early investigators (FABRE-DOMERGUE and BIÉTRIX, 1897; HERTLING, 1932; SOLEIM, 1940, 1942; MORRIS, 1956) have correlated the time span of increased larval mortality, the 'critical period', with the depletion of yolk-sac nutrients and the beginning of external food uptake. Such change-over could certainly be critical; it involves a variety of factors related to nutritional physiology and to behaviour. However, other circumstances may contribute to sudden high larval mortalities. In cod and herring larvae, HJORT (1914, 1926) related the high larval mortalities both to lack of adequate external nutrition towards the end of the yolk-sac stage and to water currents which transport the larvae to areas favourable or unfavourable to their development. Similar opinions have been expressed by other investigators (e.g. SUND, 1924; SETTE, 1943; STEVENSON, 1962). MARR (1956) has largely rejected the whole concept, and GULLAND (1965) simply defined the critical period as the life-cycle stage in which year-class strength is determined. Often viewed differently by culturists and fisheries biologists, the critical period has remained an ambiguous but much discussed concept to this day.

Reviewing most of the earlier evidence, MARR (1956) distinguishes 3 types of survival curves obtained for fish larvae: (i) the 'critical period' type, with catastrophic mortalities restricted to a brief period; (ii) constantly increasing survival rates; and (iii) constant survival rates. MARR (p. 169) concludes that the question of whether there is a critical period under natural conditions in fish larvae cannot yet be answered categorically. While catastrophic mortalities narrowly restricted in time may occur, he feels that 'the weight of what little evidence there is' points toward a constantly increasing survival rate or a constant survival rate.

However, to our knowledge, constantly increasing or constant survival rates, if

they occur at all, seem to be rare during early ontogeny of marine fishes and invertebrates—especially in species which produce hundreds of thousands or millions of eggs per female during one spawning season. Since field survival curves vary in different species and under different environmental and nutritional conditions (as well as with the method employed for measuring survival), generalizations are difficult. Nevertheless, there seem to be at least three major circumstances which are likely to cause sudden high mortalities:

(i) Competition for food must be assumed to attain critical intensities among billions of larvae which occur suddenly in a limited area, have identical nutritional requirements, and must meet these requirements immediately. Many planktonic larvae seem to have survival chances only if they find themselves in a batch (cloud) of food organisms at the time when external food uptake becomes essential (see also p. 982). Later they may learn to search for food batches and to stay with them. The danger of lethal undernutrition decreases as the number of larvae is decimated, as the survivors improve their prey-catching and prey-selection potential, as the size and quality spectra for potential prey increase, and as the growing larvae become more resistant to prolonged starvation.

(ii) Large aggregations of larvae are likely to attract and sustain large numbers of predators and to enhance the spread of diseases. Early larvae are usually more vulnerable to parasites and microbial infection than are later life-cycle stages (Chapter 9). Insufficient locomotory escape capabilities and lack of experience render early larvae easy prey. (However, in a study on *Clupea pallasii* larvae, STEVENSON (1962) considers neither predation nor lack of food to be important mortality factors in inshore areas.) Predator avoidance usually improves as the larvae grow older.

(iii) The selective force of specific water-body characteristics (biological, chemical, physical) can be expected to act more severely on early larvae than on later life-cycle stages. The capacity for non-genetic adaptation usually begins to develop in later larvae or in juveniles; it is absent or very poorly developed in embryos and early larvae (e.g. USHAKOV, 1968; Volume I: KINNE, 1970, e.g. pp. 440, 477). Within a given larval population, early environmental adjustments of the total range of genotypes present are possible only at the expense of individual lives.

MAY (1974), who set out to assess HJORT's (1914, 1926) critical period concept, concludes in his review that a multiplicity of ecological and species-specific variables affect the survival of fish larvae and that it is impossible for any single mechanism to explain larval survival in all cases. Yet, to MAY, starvation at the end of the yolk-sac stage seems indeed to play a major role. Since a variety of causes may contribute to sudden high larval mortalities, it appears most useful to define the critical period in the life of a larva simply as a stage characterized by increased mortality due to nutritional inadequacies, to interference of other organisms (competitors, predators, disease agents) or to environmental stress.

Environmental Requirements

Experimental evidence obtained on cultivated fish larvae indicates that incompatibility between genetic constitution and culture environment may contribute significantly to increased larval mortality. Of particular importance are (i) nutrition

(e.g. food-item size, nutritional value, concentration; feeding schedule); (ii) illumination suitable for proper visual orientation (prey catching, obstacle avoidance, schooling); (iii) photoperiods long enough for sufficient feeding activities; (iv) adequate intensities of other essential environmental factors (e.g. temperature, salinity, water movement and dissolved gases); (v) changes in environment and nutrition concurrent with the progressing development of the larvae. Environmental factors which are of major importance for marine fish larvae—such as light, temperature, salinity, water movement, substratum and dissolved gases—have been dealt with in Volume I. Other important aspects involve water-quality management and technology (Chapter 2), contamination of culture media (Chapter 7), diseases LAUCKNER (in press) and spatial requirements.

The spatial requirements of captive fish larvae depend to a large extent on their locomotory activities. Four principal types of locomotory pattern may be distinguished: drift-bursts, i.e. passive drifting alternating with occasional swimming bursts; swim-gliding, i.e. swimming alternating with gliding; perpetual swimming; and prey catching (p. 991). The dominating type of locomotion may change during larval development. In the anchovy *Engraulis mordax*, for example, up to 1-day-old yolk-sac larvae spend 95% of the time drifting (HUNTER, 1972). With their heads pointing downward, they float about motionless in water currents. Once a minute, without apparent external stimulation, the passive drifting is interrupted by a brief (1 to 2 secs) burst of swimming. During such a burst, tail and body beat ceaselessly from side to side. The regularly occurring bursts may have a respiratory function: facilitation of gas exchange through the integument of the larvae which have no functional gill filaments. Four-day-old larvae (end of yolk absorption, beginning of food search) spend 85% of the time in swim-gliding, 7% in feeding, and only 4% in passive drifting. Swim-gliding is characterized by alternate periods of tail beating and gliding: typically, the larva performs one full tail beat and then pauses while gliding forward. In anchovy, swim-gliding remains the dominant locomotory activity throughout larval life.

Perpetual swimmers are often pelagic forms which are genetically adjusted to life in a spatially 'unlimited' environment. Pelagic perpetual swimmers tend to move ceaselessly and to maintain a certain direction. They are not used to making major directional changes, except for prey catching, predator avoidance or schooling. The accommodation of pelagic perpetual swimmers in culture systems may cause problems. Frequently they fail to adjust to the narrow restrictions of the culture enclosure. The detrimental effects of tank-wall collisions can be reduced by (i) light gradients, i.e. the provision of optimum light conditions in the centre of the culture enclosure and pessimum conditions at its periphery; (ii) the use of round culture enclosures with a dark, smooth, soft inner surface (e.g. sheets of thin, non-toxic plastic material); (iii) water movement which carries the larvae away from solid surfaces; (iv) raceways with water-flow speeds, exactly matching those of the travelling larvae. In contrast, late larvae of flatfishes are genetically adjusted to life near solid surfaces. After a brief pelagic phase, their locomotory pattern becomes more and more substrate oriented. The larvae are accustomed to avoiding or to contacting solid objects and, hence, can be accommodated more easily in the small culture enclosures.

In many cases, round or oval culture enclosures of non-transparent, black or

blue-green PVC have proved useful for rearing marine fish larvae. While dimensions of 50-cm diameter and 40-cm height (20- to 30-cm water depth) may be adequate for most larvae, in special instances deeper or larger enclosures may be necessary. In some cases, large outdoor tanks of several thousand litre capacity were found more suitable than smaller enclosures. The enclosures should be illuminated from above, preferably by employing natural or close-to-natural quantities and qualities of illumination (Chapter 2, p. 197) and long-day conditions (or continuous illumination). It seems that close-to-natural light conditions are essential, at least in some forms, for normal development.

Among the large variety of culture enclosures found suitable for rearing of fish larvae are aquaria (p. 59), small raceways (p. 60) or laboratory streams (p. 204), planktonkreisel (p. 225), double cuvette (p. 227), 'Meteor' plankton cuvette and double cylinder (p. 230), *in situ* kreisel (p. 232), planktonrotor (p. 233), or the culture systems shown on pp. 234 to 241.

Nutritional Requirements

For successful fish-larvae rearing, adequate nutrition is often more essential than any other aspect. We summarize here some points of general significance, and briefly discuss the principal value of different types of food items for cultured fish larvae. Dynamic aspects of food uptake in fish larvae have been reviewed in Volume IV: CONOVER (in press).

Points of general significance are: (i) Only healthy larvae, exposed to an adequate culture environment can be expected to exhibit normal feeding activities; immediately after hatching, the larvae of most marine fishes exist on yolk reserves; they can feed only after their eyes, mouth parts and intestine have become functional, i.e. usually shortly before the yolk is completely absorbed. (ii) Larval anatomy, behaviour and metabolism are adjusted to food-item size, shape, locomotory pattern and chemical composition. Hence, studies of these properties—in addition to stomach-content analyses of wild populations—will help to select suitable diets. (iii) The larvae may catch and ingest food items that cannot be sufficiently digested and absorbed, or that do not fully satisfy all nutritional requirements. Consequently, whether a given food is adequate or not can only be determined on the basis of growth obtained over extended periods of time. (iv) In general, multi-component (mixed) diets have a greater chance to meet all nutritional requirements than single-compound diets. (v) Next to food-item size (p. 981) and quality, food-item concentration (p. 982) is of paramount importance. Together with larval swimming activity and water movement, food-item concentration determines the frequency of larva-food encounters. Too high food concentrations reduce water quality (Chapter 2) or cause mechanical damage (which, in turn, may render the larvae easy prey to their animal food organisms such as copepods or facilitate infection); too low concentrations result in undernourishment and starvation. (vi) For nutritional studies, food items of reproducible quality are desirable. For this reason, living food offered should be cultivated under known (standardized) environmental and nutritive conditions.

The amount of food consumed varies with the species examined, larval size and as a function of environmental factors (Volume I). In *Clupea harengus* larvae,

ROSENTHAL (1969b) estimated the normal daily ration to be 30 to 60 copepod nauplii for 10- to 11-mm long larvae and 80 to 120 copepod nauplii for 13- to 14-mm larvae (1500 lux at water surface; 12-hr day; 31 to 32‰ S). For further examples consult Volume IV: CONOVER (in press).

Type of food items

In oceans and coastal waters, the larvae of most fishes seem to feed primarily on zooplankters, especially on copepod nauplii (p. 786). Apparently, phytoplankters are of less importance and serve as supplementary rather than primary food source. Copepod nauplii, copepodites and adult copepods provide considerable variability in terms of species, size and quality.

Wild plankton, the natural food source of fish larvae, has often been offered to cultured representatives—especially in cases where the actual food required by the larvae was unknown or where sufficient amounts of defined living food were not available. Wild plankton may be an excellent food source for raising larvae. It provides diversity and thus offers a basis for selective feeding. However, there are a number of serious drawbacks to wild plankton: its composition and quality are largely unknown, variable and uncontrollable; its availability depends on weather conditions and season; the control of predators, competitors and parasites is difficult or impossible; microbial disease agents may be introduced and subsequently damage or kill whole cultures. Numerous zooplankters such as medusae, ctenophores, copepods, amphipods, euphausiids and chaetognaths are known to prey on fish larvae (consult, for example, GARSTANG, 1900; LEBOUR, 1925; LILLELUND, 1967; KABATA, 1970; LILLELUND and LASKER, 1971; GREVE, 1972; THEILACKER and LASKER, 1974; VON WESTERNHAGEN and ROSENTHAL, 1976). In addition, living wild plankton cannot be stored over extended periods of time, and is often laborious to collect in large amounts.

A summary of food items offered to captive fish larvae is presented in Table 5-92. We may distinguish 7 different types of food items: micro-organisms, protozoans, planktonic algae, benthic algae, planktonic animals, benthic animals and non-living food items.

A critical analysis of the potential food value to fish larvae of micro-organisms is not available. Conceivably, micro-organisms, such as bacteria or fungi, could play a role in certain larvae which take up detritus. Detritus particles could provide nutrients due to their non-living organic contents and their microbial flora. Such a possibility remains to be investigated. Most likely, the importance of micro-organisms as food for fish larvae is rather limited.

Protozoans have been suspected or demonstrated to be of nutritional significance, e.g. for larval *Mylio macrocephalus* (KASAHARA and co-authors, 1960: *Stylonychia* sp.) and larval *Solea solea* (FLÜCHTER, 1974: identity of protozoans unknown). The potential nutritional value of protozoans for fish larvae remains a matter of debate. New, critical investigations are necessary.

Planktonic algae turned out to be insufficient as sole food source for most larvae examined. The only definite case known in which a defined phytoplankter has supported prolonged growth involves the naked dinoflagellate *Gymnodinium splendens* which has supported larvae of the northern anchovy *Engraulis mordax* (LASKER and co-authors, 1970); however, a combination of *G. splendens* and veliger

Table 5-92

Food items offered to captive fish larvae (Based on a compilation by MAY, 1970, 1971, from the sources indicated)

Food organism	Author
Micro-organisms	Possibly of importance for suspension and deposit feeders. No definite information available.
Protozoans	
<i>Euplotes</i> sp.	FABRE-DOMERGUE and BIÉTRIX (1897)
<i>Philaster digitiformis</i>	FABRE-DOMERGUE and BIÉTRIX (1897)
<i>Stylonychia</i> sp.	KASAHARA and co-authors (1960)
Tintinnids	KRAMER and ZWEIFEL (1970)
Planktonic algae	
<i>Biddulphia mobiliensis</i>	HERTLING (1932)
<i>Chaetoceros</i> sp.	DAVID (1939)
<i>Chlamydomonas</i> sp.	GROSS (1937), QASIM (1955, 1959), BISHAI (1961), BLAXTER (1962, 1969)
<i>Chlorella</i> sp.	BLAXTER (1962)
<i>C. stigmata</i>	QASIM (1955)
<i>Chromulina pusilla</i>	QASIM (1955)
<i>Coscinodiscus concinnus</i>	HERTLING (1932)
<i>C. radiatus</i>	GROSS (1937)
<i>Cryptomonas maculata</i>	BLAXTER (1969)
Diatoms	DAVID (1939), RUBINOFF (1958)
<i>Ditylum brightwellii</i>	BLAXTER (1969)
<i>Dunaliella primolecta</i>	BLAXTER (1969)
<i>D. salina</i>	FABRE-DOMERGUE and BIÉTRIX (1905)
<i>D.</i> sp.	BUDD (1940), MORRIS (1956), BLAXTER (1962), DELMONTE and co-authors (1968)
<i>Fragilidium heterolobum</i>	LASKER and co-authors (1970)
<i>Gymnodinium splendens</i>	LASKER and co-authors (1970)
<i>Halosphaeria minor</i>	BLAXTER (1969)
<i>Isochrysis galbana</i>	QASIM (1955, 1959)
<i>Lauderia borealis</i>	BLAXTER (1969)
<i>Monochrysis lutheri</i>	FORRESTER (1964)
<i>Nitzschia closterium</i>	ORCUTT (1950)
<i>N.</i> sp.	BUDD (1940), BISHAI (1961), BLAXTER (1962)
<i>Olisthodiscus</i> sp.	BLAXTER (1969)
<i>Oxyrrhis marina</i>	MORRIS (1956)
<i>O.</i> sp.	KASAHARA and co-authors (1960)
<i>Platymonas subcordiformis</i>	ORCUTT (1950)
<i>Prorocentrum micans</i>	GROSS (1937), QASIM (1955), BLAXTER (1969), LASKER and co-authors (1970)
<i>Protoceratium reticulatum</i>	LASKER and co-authors (1970)
<i>Rhizosolenia</i> sp.	DAVID (1939)
<i>Skeletonema costatum</i>	GROSS (1937), KURATA (1956, 1959), BLAXTER (1962), FORRESTER (1964)
<i>Stichococcus</i> sp.	MORRIS (1956)
<i>Thalassiosira</i> sp.	GROSS (1937)
Fungi	
Yeast	MORRIS (1956), KLIMA and co-authors (1962)

Table 5-92—Continued

Food organism	Author
Benthic algae	
Blue-green algae	FABRE-DOMERGUE and BIÉTRIX (1897)
<i>Enteromorpha</i> sp.	KOTTHAUS (1939)
Filamentous algae	DELMONTE and co-authors (1968)
Filamentous brown diatom	FABRE-DOMERGUE and BIÉTRIX (1897)
Planktonic animals	
<i>Arbacia</i> sp. (eggs or larvae)	RUBINOFF (1958), DEUEL and co-authors (1966)
<i>Artemia salina</i> (nauplii)	Most investigators engaged in fish-larvae cultivation
Ascidian (larvae)	FABRE-DOMERGUE and BIÉTRIX (1897)
<i>Asterias</i> sp. (eggs)	BLAXTER (1962)
<i>Balanus amphitrite albicostatus</i> (nauplii)	KASAHARA and co-authors (1960), HIRANO (1969)
<i>B. balanoides</i> (nauplii)	SOLEIM (1942), DANNEVIG (1948), QASIM (1955, 1959), BLAXTER (1962, 1968), SHELBOURNE (1964)
<i>B. glandula</i> (nauplii)	MORRIS (1956)
<i>Brachionus plicatilis</i>	HIRANO (1969), MITO and co-authors (1969), OKAMOTO (1969)
<i>Bulla gouldiana</i> (larvae)	LASKER and co-authors (1970)
<i>Chone teres</i> (larvae)	KURATA (1959)
Cladocerans	GROSS (1937)
Copepods (adults)	GROSS (1937), BÜCKMANN and co-authors (1953), BISHAI (1961), FISHELSON (1963), HIRANO (1969)
Copepods (nauplii)	KOTTHAUS (1939), KASAHARA and co-authors (1960)
<i>Crassostrea gigas</i> (larvae)	HIRANO (1969)
<i>Crepidula</i> sp. (larvae)	RUBINOFF (1958)
<i>Daphnia pulex</i> (eggs)	MCMYNN and HOAR (1953)
<i>D.</i> sp.	BÜCKMANN and co-authors (1953)
<i>Dendroaster excentricus</i> (eggs or larvae)	MORRIS (1956)
Fertilized sea urchin eggs	FUJITA (1965)
Fishes (larvae)	FABRE-DOMERGUE and BIÉTRIX (1905)
<i>Haminoea vesicula</i> (larvae)	LASKER and co-authors (1970)
<i>Mytilus californianus</i> (larvae)	MORRIS (1956)
<i>M.</i> sp. (larvae)	KOTTHAUS (1939), SCHACH (1939), DANNEVIG (1948), KURATA (1956), BLAXTER and HEMPEL (1961a, b), OKAMOTO (1969)
Nudibranchs (larvae)	KOTTHAUS (1939)
<i>Navanax inermis</i> (larvae)	LASKER and co-authors (1970)
<i>Neomysis japonicus</i> (juveniles)	KASAHARA and co-authors (1960)
<i>Nereis</i> sp. (eggs)	CUNNINGHAM (1893-95)
<i>Ostrea edulis</i> (larvae)	DANNEVIG (1948)
Oyster (larvae)	OKAMOTO (1969)
<i>Pomatoceros</i> sp. (larvae)	DANNEVIG (1948)
<i>Strongylocentrotus purpuratus</i> (eggs or larvae)	BUDD (1940), ORCUTT (1950), MORRIS (1956)
<i>Tigriopus californicus</i> (nauplii)	FAHEY (1963)
<i>T. fulvus</i> (nauplii)	BUDD (1940), ORCUTT (1950), BISHAI (1961)
<i>Tripneustes esculentus</i> (eggs or larvae)	RICHARDS and PALKO (1969)

Table 5-92—Continued

Food organism	Author
Benthic animals	
<i>Anguillicula</i> sp.	BLAXTER (1962)
<i>Tigriopus fulvus</i> (adults)	MORRIS (1956), BLAXTER (1968)
<i>Tisbe</i> sp.	BLAXTER (1962)
Non-living food items	
Commercial fish-fry foods	BLAXTER (1962), KLIMA and co-authors (1962), DELMONTE and co-authors (1968)
Cooked chicken egg yolk	FABRE-DOMERGUE and BIÉTRIX (1897), HEUTS (1947), BÜCKMANN and co-authors (1953), MORRIS (1956), NIKITINSKAYA (1958), KURATA (1959), KLIMA and co-authors (1962), FISHELSON (1963), IVANCHENKO and IVANCHENKO (1969), FUJITA (1966)
Crushed mussel	FABRE-DOMERGUE and BIÉTRIX (1897)
Finely ground trout food	RICHARDS and PALKO (1969)
Homogenates of <i>Mytilus</i> , periwinkle, <i>Fucus</i> and kelp	IVANCHENKO and IVANCHENKO (1969)
Human blood	KLIMA and co-authors (1962)
Liver of shore crab <i>Carcinus maenas</i>	BISHAI (1961)
Liver-skim milk	MCMYNN and HOAR (1953)
Minced shrimp and crab meat	KURATA (1959)
Powdered fish foods	RUBINOFF (1958)
Water-soluble vitamin compounds	KLIMA and co-authors (1962)

larvae of the mollusc *Bulla gouldiana* supported larval growth better than *G. splendens* alone, and best growth was achieved with wild plankton. Possibly, phytoplankton—either consumed directly or via phytoplankton-feeding zooplankters—plays primarily a role as supplementary diet (e.g. source of vitamin or other substances required in small amounts). Phytoplankton may also enhance survival and/or growth by improving the water quality (see below). Even in some herbivorous fishes, such as the rabbitfish *Siganus canaliculatus*, the larvae appear to depend on zooplankters; only later stages (after metamorphosis; MAY and co-authors, 1974) turn to plant food as primary food source, e.g. to *Enteromorpha* sp. and other multicellular benthic algae. Larvae of the milkfish *Chanos chanos* can subsist, from early fry stage (less than 1 week after hatching) to an age of 11 weeks, largely on plant food (VILLADOLID, 1957), particularly on phytoplankton (mainly diatoms such as species of *Pleurosigma*, *Navicula*, *Cocconeis*, *Suriella*, *Amphora*, *Nitzschia*, *Melosira*, *Coscinodiscus*, *Chaetoceros*). VILLADOLID further lists the following food items: blue-green algae (species of *Lyngbya*, *Phormidium*, *Microcystis*), green algae (*Cosmarium*), dinoflagellates (*Peridinium*, *Tintinnus*) and filamentous green algae (*Chaetomorpha*, *Enteromorpha*), as well as rotifers (*Brachionus* eggs), nauplii of ostracods and copepods, and fish eggs.

'Blooms' of planktonic unicellular algae such as *Chlorella* sp. have been reported to improve the chances for successful rearing of fish larvae which are particularly difficult to maintain in captivity. Tuna larvae (*Euthynnus alletteratus*), for example, could be reared by HOUDE and RICHARDS (1969) beyond the yolk-sac stage only if

Chlorella sp. had been added to the culture water (76-l aquaria or 530-l fibre-glass tanks; aerated water; continuous artificial illumination; ca 26° C). The role of *Chlorella* sp. in promoting rearing success is unknown. The tuna larvae fed on wild zooplankton (copepod nauplii and copepodites). Possibly the algae affect water quality or provide dissolved, life-supporting substances (see also Chapter 2, p. 129).

Benthic algae play a less important role as larval food than phytoplankton. However, benthic diatoms and a large variety of multicellular benthos algae, such as *Enteromorpha* sp., *Ulva* sp., etc., are utilized by juveniles and adults of herbivorous fishes.

Planktonic animals constitute the main and best food source for most marine fish larvae. Copepods (mainly nauplii, but also copepodites and adults) comprise a major portion of the natural diet and have been used as food organisms for cultured fish larvae with considerable success. However, a few copepods have been shown to prey on fish larvae (LILLELUND and LASKER, 1971). Other zooplankters that have served as food for cultured larvae include rotifers, larvae of annelids, cirripedes, decapods, bivalves, gastropods, echinoderms and fishes. For many of these potential food organisms, culture methods have been reviewed in this chapter.

Nauplii of *Artemia salina* (p. 747) have been used most frequently as food for reared fish larvae. In numerous instances, they proved to be good food. However, in some cases, *A. salina* nauplii were defecated before digestion had been completed. More recently, rotifers, such as *Brachionus plicatilis* and *B. rubens* (p. 688), as well as several copepods (p. 786), have been used increasingly as food for captive fish larvae.

Examples of benthic animals fed to fish larvae are small annelids and copepods such as *Tisbe reticulata*, *Tigriopus fulvius* and *T. californicus*. The fish larvae reported to feed on benthic copepods belong to the following species: *Solea solea*, *Pleuronectes platessa*, *Clupea harengus*, *Alosa pseudoharengus*, *Bairdiella chrysura*, *Mugil cephalus*, *Leuresthes tenuis* and *Aulorhynchus flavidus*. Since adults of the copepods mentioned move quickly and readily escape into hiding places, their free-swimming larvae seem to have served primarily as food.

Among the non-living diets fed to fish larvae, commercial fish foods and micro-encapsulated diets (pp. 583, 915, 1373) play a dominant role. In addition, fine particulate cooked egg yolk and powdered meat of crabs, squid, fish or beef liver have been offered. In general, fish larvae seem to grow better on living than on non-living foods. In many cases, non-living foods turned out to be insufficient unless supplemented by living foods. Some fish larvae may require complex substances that are too fragile to exist for long outside a living cell.

Multi-component diets are usually more successful in supporting fish larvae than are single-component diets. In some cases, series of food organisms have been offered in feeding schedules that paralleled the progressing development of the fish larvae concerned. OKAMOTO (1969), for example, raised larvae of the sea bream *Pagrus major* on the following series: oyster and/or mussel trochophores, rotifers (*Brachionus plicatilis*), cirripede nauplii, *Artemia salina* nauplii, annelid larvae, shrimp meat, fish meat. In each case, the new diet was applied in such a way that sufficient overlapping (several days) with the preceding diet was assured; this allowed the *P. major* larvae to adjust to the new diet; at the same time, individual differences in fish-larva development were compensated for.

Larvae of the garpike *Belone belone* accept a large variety of food-item sizes (e.g. *Enchytraeus* sp., *Daphnia* sp., *Cyclops* sp., *Artemia salina*, *Tubifex* sp., freeze-dried chironomid larvae and Tetramin, ROSENTHAL and PAFFENHÖFER, 1972). While daphnids are almost completely digested, the garfish were not able to extract much of the high-calorie compounds from Tetramin. *Engraulis mordax* have been reared from hatching through metamorphosis on a diet consisting of *Gymnodinium splendens*, *Brachionus plicatilis*, *Tisbe furcata* and nauplii of *A. salina* (HUNTER, 1972 and unpublished). At 16° C, the larvae completed metamorphosis (35 mm) in 74 days with a minimum survival of 12.5%. Growth rate was comparable to that of larvae fed a wild-plankton diet.

Table 5-93
Artificial diet used for rearing larvae of the plaice
Pleuronectes platessa (After ADRON and co-authors, 1974;
not copyrighted)

Component	g*[100 g of dry diet] ⁻¹
Freeze-dried cod muscle	53.4
Freeze-dried whole hen's egg	10.0
Shrimp meal	10.0
Cod-liver oil	4.0
Encapsulated vitamin mixture	3.3
Vitamin mixture†	2.8
Mineral mixture†	1.0
Glucose	5.0
α-tocopherol	0.4
Sunset yellow F.C.F.	0.1
Furanace	0.8 mg
Gelatin	10.0
Water‡	150.0 ml

*Unless otherwise stated.

†Cowey and co-authors, 1972.

‡Removed finally by freeze drying.

Newly hatched plaice *Pleuronectes platessa* have been raised to metamorphosis on an artificial diet (Table 5-93) at survival rates of 20%, i.e. below those of controls (38%) fed *Artemia salina* nauplii (ADRON and co-authors, 1974; see also COWEY and co-authors, 1970a, b). The diet contained 70% crude protein, 9.7% lipid, 7.9% ash and 5% digestible carbohydrate, and was administered automatically in particle sizes ranging from 180 to 355 μm. Once the larvae had started to feed well, mortalities decreased and became sporadic. Some larvae began to metamorphose 35 days after hatching (fluorescent light, 250 lux at water surface; 10° C). Larvae of the lemon sole *Microstomus kitt* have been raised successfully on *Brachionus plicatilis* and *Mytilus edulis* trochophores (HOWELL, 1971). Larvae of *Solea solea* and *Scophthalmus maximus* developed on *Brachionus plicatilis*, *Artemia salina* nauplii and mussel trochophores (HOWELL, 1973). For early larvae, *A. salina* nauplii turned out to be too large to be eaten. Initial feeding with *B. plicatilis*, followed by *A. salina* nauplii and/or *Phaeodactylum* sp. after some 14 days, was

quite successful. Larvae of *M. kitt* also grew well on an initial diet of rotifers and then, after 40 to 52 days, on *A. salina* nauplii.

Absolute requirements of fish larvae, e.g. for amino acids or vitamins have not yet been established. The pertinent information available on other animal groups, especially protozoans (p. 584) and crustaceans (p. 814), may help to stimulate comparable work on fishes. Dissolved organic matter (DOM) has been suggested to be of nutritional importance for larvae of the sole *Solea solea* (FLÜCHTER, 1974). This suggestion requires critical examination. The nutritional significance of DOM for marine invertebrates has been reviewed in the preceding sections of this chapter (see also Volume II: PANDIAN, 1975, and Volume IV: WANGERSKY, in press; CONOVER, in press; SOROKIN, in press). JOCHIMS (personal communication) has demonstrated peripheral DOM uptake (glucose) in the freshwater fishes *Cyprinus carpio*, *Poecilia reticulata* and *P. latipinna*. Although the glucose taken up accumulates in metabolically active organs such as liver, kidney, intestine and nerves, the significance of DOM uptake for meeting at least a portion of the fishes' nutritional requirements remains to be shown unequivocally.

Size and structure of food items

The size of the food items consumed depends, of course, on larval size. Young herring larvae, for example, have been reported to eat very small prey such as *Coscinodiscus* sp. of 0.15 mm (HARDY, 1924); up to 18-mm long larvae take *Tintinnopsis* sp. of 0.08 × 0.07 mm (HENTSCHEL, 1950) or 0.1-mm trochophores of *Mytilus edulis* (BLAXTER and HEMPEL, 1961a); juveniles up to 40 mm manage to catch large plankters such as 0.4-mm nauplii of *Artemia salina*. For more details consult the review by BLAXTER (1965). The importance of prey size for clupeoid larvae has also received attention from ARTHUR (1956) and BHATTACHARYYA (1957).

Pelagic larvae of the plaice *Pleuronectes platessa* in the southern North Sea feed, according to SHELBORNE (1953, 1962), almost exclusively on the appendicularian *Oikopleura dioica*. The size of the prey eaten can be estimated from the faecal pellets of *O. dioica* found in the larval gut. SHELBORNE's study reveals that maximum prey size increases as the *P. platessa* larvae grow. At late pelagic larval stages, all sizes of *O. dioica* are included in the diet. Large fish larvae can prey on a wider size range than small larvae and, hence, command larger potential food resources.

In addition to body size, the prey's structure, i.e. the length of its appendages and spines is of importance. Long appendages and spines may render prey unacceptable or uncatchable. Copepods with long antennae, for example, can only be swallowed with the antennae folded back along their body (e.g. BLAXTER, 1965). Long spines may protect potential prey from being caught. Very spiny organisms (e.g. some *Ceratium* species) might not pass through the mouth. Unavailability or rejection of prey with spiny structures could save the intestinal tract from becoming ruptured. Cell-wall properties (thickness, chemical composition) may greatly affect the digestibility of swallowed prey. Captive fish larvae have often caught and swallowed prey which they could not, or only insufficiently, digest and which passed their intestine largely unaffected.

Concentration of food items

The concentration of food items is of basic importance for survival and growth

of fish larvae. It determines the number of potential encounters per unit time between predator and prey and, hence, the chances for obtaining food, and it affects the relationship between energy expenditure and gain during prey-searching activities.

In oceans and coastal waters, the food available for fish larvae appears to occur often at concentrations which are near or below the larva's minimum requirements. The youngest feeding stages seem to depend largely on local above-average food-item concentrations. Only those early larvae which find themselves in patches (clouds) of planktonic food are likely to survive in appreciable numbers. If outside a food cloud, when external food uptake begins, many or most larvae will die unless carried to a water body with a higher food concentration before reaching the point of no return (p. 987). Cultivation studies make high field-survival rates of marine fish larvae unlikely at the low average food-item concentrations normally prevailing in the sea (e.g. O'CONNELL and RAYMOND, 1970; HUNTER, 1972; SAKSENA and HOUDE, 1972; HOUDE, 1974; HUNTER and THOMAS, 1974). The chances for meeting minimum food-item-concentration requirements of young feeding stages may be increased due to parental spawning-area selection and, later, due to active search of the growing larvae.

Calculations of the minimum food-item concentration required by marine fish larvae are difficult. All essential parameters are subject to variation—often to such an extent that calculations become reduced to rough hypothetical estimates at the best. Essential variable factors include day length, temperature and water movement; prey type, e.g. size, motility and digestibility; and larval characteristics, e.g. age, size, morphological differentiation, motility, experience, food-conversion efficiency and nutritional plasticity.

On the basis of early literature data, BLAXTER (1965) has concluded that food concentrations in the natural environment of clupeoid larvae range from 1 to 68 items l^{-1} . For captive larvae of the herring *Clupea harengus*, ROSENTHAL and HEMPEL (1970) have shown that the minimum food-item concentration required varies with age (size) of the larvae (Table 5-94). The requirements of 10- to 11-mm long larvae have been estimated to lie between 4 to 8 and 21 to 42 *Artemia salina* nauplii l^{-1} . The minimum estimate is based on the assumption that the larvae attempted to catch all prey which entered their perceptive visual field; the maximum estimate, on the assumption that only part of the prey organisms perceived stimulated prey-catching activities. Experiments conducted by SAKSENA and HOUDE (1972) on larvae of *Harengula pensacolatae* indicate that 500 to 1000 zooplankters l^{-1} sustain adequate growth in *H. pensacolatae*, but 1500 to 2000 zooplankters l^{-1} were required to rear bay anchovy *Anchoa mitchilli*. The food offered in these experiments consisted of wild plankton (mostly copepod nauplii and copepodids).

For larvae of the anchovy *Engraulis mordax*, HUNTER (1972) estimated the concentration of rotifers *Brachionus plicatilis* and dinoflagellates *Gymnodinium splendens* required to meet the larva's metabolic needs. His calculations are based on calorific and respiratory data, on the water volume searched (p. 997) and on prey-catching success (p. 994). HUNTER's results are illustrated in Fig. 5-101. They indicate that larvae just after yolk-sac absorption require up to 37 times higher food-item concentrations than older larvae. Hence, after yolk-sac absorption, *E. mordax* larvae are more likely to die from starvation than at any other life-cycle

stage (see also *Critical Period*, p. 971). Three-day-old larvae (3.5 mm) require 105 *B. plicatilis* l⁻¹ during a 10-hr feeding period, whereas 10-day-old larvae (5.9 mm) require only 34 rotifers l⁻¹.

HUNTER (1972) points out that in *Engraulis mordax* larvae feeding on high concentrations of food items, only about 40% of the prey-catching procedures were completed. Thus, when using a criterion similar to that employed by ROSENTHAL and HEMPEL (1970), the maximum estimate for the prey concentration required by *E. mordax* larvae would be 2.5 times the minimum estimate (for a 10- to 11-mm *Clupea harengus* larvae ca 72 rotifer equivalents l⁻¹). Considering species-specific differences and the differences in assumptions and procedures, HUNTER concludes that the estimated food-concentration requirements of *C. harengus* larvae do not differ much from those of *E. mordax* larvae.

Table 5-94

Clupea harengus. Estimated prey density (*Artemia salina* nauplii) required for optimum feeding conditions of Downs larvae; (a), (b): see footnote to table (After ROSENTHAL and HEMPEL, 1970; modified; reproduced by permission of Oliver & Boyd, Edinburgh)

Age (days)	Total length (mm)	Volume of water searched day ⁻¹ (1)	Successful prey catching (%)		Daily ration (number of prey consumed)	Number of prey encounters day ⁻¹		Number of nauplii l ⁻¹ required	
			(a)	(b)		(a)	(b)	(a)	(b)
6-9	10-11	20-30	6	40	40	750	135	21-42	4-8
13-30	13-14	40-100	10	60	50	1000	170	13-25	2-4

Two food-density estimates are given, based on assumptions (a) and (b): (a) only a portion of the plankters visually perceived cause snapping actions with a low rate of success; (b) all plankters visually perceived cause snapping actions at the same rate of success. At high prey densities, the larvae respond to more prey than they 'intend' to eat; hence, (a) tends to overestimate the number of prey. In contrast, (b) estimates minimum values since hungry larvae tend to snap at all food items within their field of vision.

Experiments with larvae of the anchovy *Engraulis mordax*, offered different concentrations of the dinoflagellate *Gymnodinium splendens* or the rotifer *Brachionus plicatilis*, revealed to HUNTER and THOMAS (1974) that the larvae associate with *G. splendens* patches both in light and in darkness. The larvae swim more quickly and cover a greater searched area at low prey concentrations than at higher ones. In patches of food items, swimming speed drops while feeding activity increases. The number of larvae attracted to a food-organism patch increases with the concentration and the total volume of the patch. The occurrence of potential small food items in 'clouds' seems to play a more important role in oceans and coastal waters than has hitherto been realized.

When offered concentrations of 0.1 and 0.01 zooplankters ml⁻¹ (mainly nauplii of *Acartia clausi*, *Centropages hamatus* and *Balanus balanoides*), captive larvae of the haddock *Melanogrammus aeglefinus* died within 2 or 3 weeks; at 0.5 to 3.0 plankters ml⁻¹, daily instantaneous mortality coefficients were 0.06 to 0.02 during 6 weeks. At 0.5, 1.0 and 3.0 plankters ml⁻¹, the larvae grew within 6 weeks to

average standard lengths of 8.7, 10.0 and 11.2 mm, respectively (7°C), with condition factors of 1.25, 1.22 and 1.32 (LAURENCE, 1974).

Several investigators have attempted to explore the ecological significance of prey concentration. A general discussion about responses of predators to prey density, based on the behaviour of both invertebrates (primarily insects) and

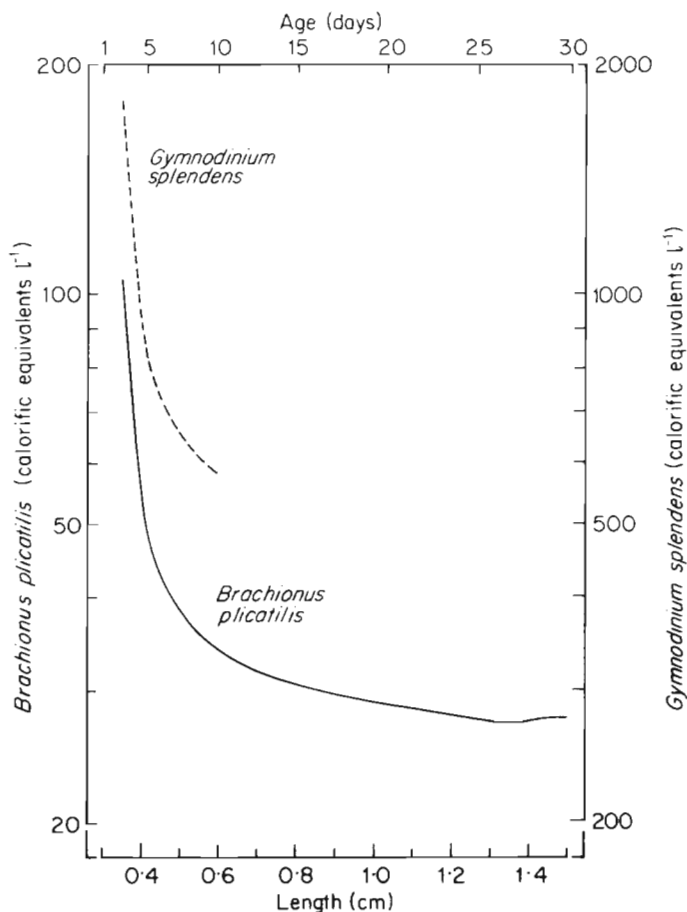

Fig. 5-101: Average estimates of food-item concentration (expressed as calorific equivalents l⁻¹ of *Brachionus plicatilis* and *Gymnodinium splendens*) necessary to meet the metabolic requirements of 0.3- to 1.5-cm long *Angraotus mordax* larvae. (After HUNTER, 1972; modified; not copyrighted.)

vertebrates, has been presented by HOLLING (1965). According to HOLLING, the components which determine the predator response include rate of successful search, predator-prey exposure time, prey-handling time, hunger and learning. HOLLING presents a mathematical model that predicts 3 different types of functional predator responses to the concentration of palatable prey (Fig. 5-102). His model faithfully reproduces important features of learning: increased attack intensity with increasing experience if the attack stimulus is associated with edible prey; decreased

attack intensity if the stimulus is associated with non-edible prey; extinction of learned responses in the absence of reinforcement. Equilibrium densities and effective dampening of oscillations are most likely with type-3 responses and least likely with type-2 responses. An increase in the number of predator species augments the chance for prey-population stabilization.

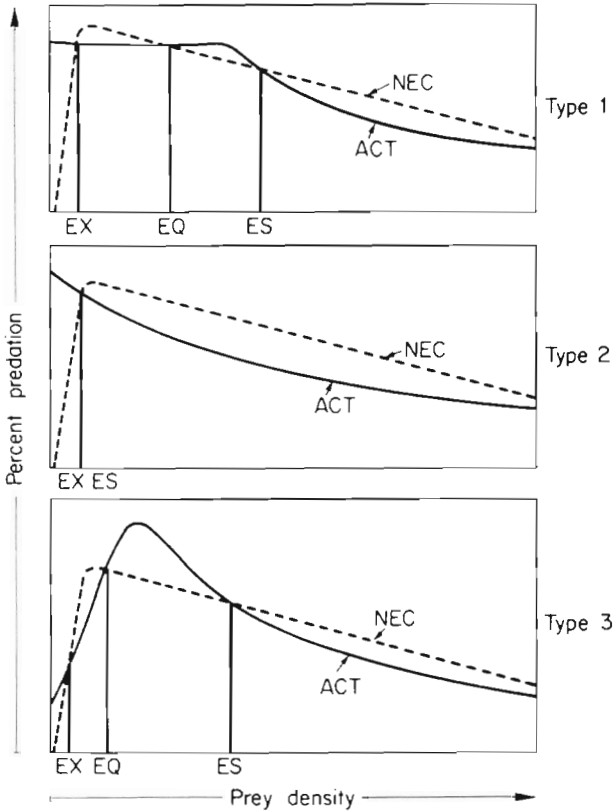

Fig. 5-102: Three different types of functional response to prey concentration. ACT: actual percent predation; NEC: percent mortality necessary to stabilize populations; EX: threshold density for population extinction; EQ: equilibrium density; ES: threshold density for population escape. (After HOLLING, 1965; modified; reproduced by permission of Entomological Society of Canada.)

The 'functional response' relates the number of prey eaten per unit time by a single 'average' predator to the size of a single-species population (OATEN and MURDOCH, 1975). The functional response may depend on other prey populations which appeal to the predator; in addition, the interference of predator individuals with each other depends on their own population density. According to MURDOCH (1969), 'switching' in predators which attack several prey species can potentially stabilize prey-population density. Switching describes the fact that the predator may

distribute its attacks in response to the relative abundance of prey species, concentrating its attacks disproportionately on the more abundant prey. There is a tendency for predation to be a fairly constant percentage of prey concentration over a rather large range of prey population densities (MURDOCH, 1971). A general equation for predation in response to food preference and food abundance has been presented by MARTEN (1973).

Phytoplankton concentration has been assumed by STEELE (1974) to represent a major factor in the dynamic stability of marine ecosystems. According to STEELE's model, phytoplankton concentration below a certain level does not elicit feeding responses in herbivorous zooplankters, thus providing a refuge. However, LANDRY (1976) demonstrated that, in certain cases, STEELE's model is 'stable' without a grazing threshold. According to LANDRY, feeding thresholds are not essential for long-term stability of the simulated system. He proposes primary ecosystem control through predation. A significant effect of predation has also been admitted by STEELE (1976) and, in fact, has been predicted to be a controlling factor in ecosystem dynamics by several ecologists for a long time (Volume V).

Food selectivity

Food selection has been claimed or demonstrated in larvae of several marine fish species. However, exact measurements are difficult. The degree of food selectivity is a function of satiation and feeding drive (appetite), and depends both on the abundance of available food and the fish's preference for particular food items (e.g. IVLEV, 1961; see also Volume IV: CONOVER, in press). A clear distinction between these different aspects is mostly not possible.

Within one and the same species, the degree of selectivity tends to increase with larval age, size and/or experience. Young herring larvae, for example, take almost any kind of floating object, including their own faeces and air bubbles (BLAXTER, 1965). However, after some experience they rapidly adjust and specialize more and more on selecting digestible food items. Once the larvae have learned to seize acceptable food, they display a certain tendency 'to stick with it' (ROSENTHAL, 1969a, b). As in other animals, inexperienced individuals seem to learn how to pick up food and how to select suitable food more rapidly in the presence of already experienced conspecifics (see also p. 991). Once a food item is seized, additional selection takes place within the mouth on the basis of taste and texture (BLAXTER and HOLLIDAY, 1958; BLAXTER, 1965). Unsuitable food items may weaken the drive to feed.

Usually, food selectivity is less pronounced in hungry or starving larvae than in well-fed ones. In addition to previous experience, the prey taken up depends on the larva's morphological characteristics (e.g. its feeding apparatus) and on feeding behaviour (p. 988). The degree to which the prey swallowed can be digested and absorbed depends on the enzymes available to the larva, its microbial intestine flora which may assist in food digestion and the period of time during which the food remains in the intestine (Volume II: PANDIAN, 1975).

A general model which relates optimal preference of potential food sources and calorific yield per unit time has been presented by EMLEN (1966) who made the following suggestions: (i) Food preferences can be adequately described only if a

number of factors other than relative frequencies in the diet and relative abundances of the types of food items are known. (ii) Predators should be more selective when satiated or when food is common, but more indiscriminate when starved or when food is scarce (see also McARTHUR and PLANKA, 1966). (iii) Predators may consume one food type with greater frequency, relative to its abundance, than another. (iv) The extent to which predators tend to pass by potential food items may be indicative of the significance of nutrition for limiting predator population size. (v) Food preferences may vary as a function of environmental change.

Starvation

In the absence of sufficient food, fish larvae eventually reach a 'point of no return' (PNR). Coined by BLAXTER and HEMPEL (1963), the PNR has later been defined as the point at which only 50% of the larvae are still able to feed if sufficient food becomes available (BLAXTER and EHRlich, 1974). Even under optimum nutritional conditions, the other 50% are no longer capable of taking up food. Apparently, the larvae are simply too weak to catch prey and/or to digest it. In individuals beyond the PNR, starvation effects have become irreversible; however, the larvae might swim about for some more days (delayed death). Thus defined, the PNR concept is a general phenomenon also applicable to other animals.

The starvation potential—i.e. the capacity to survive without food, expressed as time to death—increases from the end of the yolk-sac stage with progressing larval age. It differs in different species and depends on environmental conditions, e.g. it tends to decrease with increasing temperature. In general, factors which enhance metabolic activities must be expected to reduce the time to death.

In larvae of *Clupea harengus* and *Pleuronectes platessa*, the starvation potential varies from 6 days at the end of the yolk-sac stage to about 15 days in older larvae (7° to 12° C; 32 to 33‰S); in still older individuals, it takes 3 to 4 weeks to reach the PNR; in later life-cycle stages, herring can starve at least 129 days at 6° to 12° C (WILKINS, 1967). Newly hatched *Engraulis mordax* can survive without food from 3 days at 22° C to 5.5 days at 15° C (LASKER and co-authors, 1970); at 15° to 22° C, they can survive without food for 1.5 days after yolk-sac absorption. During advanced starvation, a tendency to 'head-heaviness' may increasingly interfere with orientation, and sinking rate often tends to decrease due to an increase in hypoosmotic body water as well as a decrease in body protein. Finally, osmoregulation fails and the larvae 'dehydrate'. In *Clupea harengus* larvae, BLAXTER (1965) calculated the condition factor during starvation as a measure of body reserves; it may be expressed as:

$$\frac{(\text{Mean dry weight of a fixed sample in mg} \times 1000)}{(\text{Mean fixed standard length}^3)}$$

Another measure of emaciation in herring larvae is body height (excluding the gut).

The starvation potentials of larvae of bay anchovy *Anchoa mitchilli*, sea bream *Archosargus rhomboidalis* and lined sole *Achirus lineatus* vary with the species concerned, temperature, and yolk-absorption time (Table 5-95). According to HOUDE (1974), lined soles survived longest, bay anchovies were intermediate, and sea bream died first. Larvae of the haddock *Melanogrammus aeglefinus* kept at 7° C

began feeding 2 days after hatching, completed yolk absorption on day 6 or 7, and reached the PNR 6 days after hatching (LAURENCE, 1974). All larvae starved for 8 or 10 days after hatching, although initiating feeding, failed to survive beyond another 4 days.

Table 5-95

Anchoa mitchilli, *Archosargus rhomboidalis* and *Achirus lineatus*. Starvation potentials for reared larvae as a function of temperature, yolk absorption and eye pigmentation (After HOUDE, 1974; reproduced by permission of Springer-Verlag)

Species	Temperature (°C)	Hours after hatching when yolk is absorbed*	Hours after eye pigmentation when		Hours after yolk absorption before which larvae must be fed
			Yolk absorbed*	Survival re- mains good if larvae fed before	
<i>Anchoa mitchilli</i>	24	41.0	7.5	40	32.5
	28	36.6	9.5	32	22.5
	32	27.4	1.0	16	15.0
<i>Archosargus rhomboidalis</i>	22	52.9	10.5	40	29.5
	26	50.0	20.5	40	19.5
	30	40.9	16.0	32	16.0
<i>Achirus lineatus</i>	24	79.8	20.5	32	11.5
	28	59.7	12.5	24	11.5
	32	58.2	12.0	—	—

* Less than 0.5% yolk remains.

Behaviour

Particularly in complex forms of life, such as fishes, behaviour may greatly affect the relation of organisms to their environment, abiotic and biotic. Some behavioural aspects have been mentioned in other sections of this review. We concentrate here on (i) insufficient or abnormal stimuli, (ii) schooling, and (iii) prey catching. These three aspects are immediately relevant to the cultivation of larvae. They are also important in juveniles and adults.

Insufficient or abnormal stimuli

For ecological experiments, culture conditions must be provided which facilitate the development of normal behaviour. Insufficient or abnormal stimuli may lead to functional and structural responses that differ significantly from those exhibited in oceans and coastal waters. Proper orientation in space and time, communication between con- and heterospecifics, and learning, as well as the maintenance of normal social structures and reproductive activities require adequate stimulus input (Volume II). Stimulus interpretation, learning and memorization—all essential aspects of the ecological potential of complex forms of life—can be expected to

function in the way they do under field conditions only in an adequately patterned, close-to-natural environment.

Ecologically meaningful culture conditions must provide appropriate sensory stimulation. BLAXTER (1970b, and in press) has suggested that sensory deprivation may be a common phenomenon in tank-raised fish larvae. He calls specific attention to culture-enclosure size; colour of enclosure walls and floor; adequate substratum; distribution and concentration of food; intra-specific competition; turnover rate and carrying capacity of the culture system (for details consult Chapter 2); and adequate sensory input of light and other environmental variables. Stimuli of particular importance to planktonic fish larvae appear to be direction, quantity and quality of illumination; adequate visual (possibly also auditory and olfactorial) inputs; and normal prey type and behaviour. In addition, proper water movement and sufficient space appear to be significant. For benthic forms, substratum properties often assume primary importance.

As in other aquatic animals, crowding may cause reduced growth and increased aggressiveness. A well-known phenomenon is the 'size-hierarchy effect', i.e. increasing size differences in coexisting individuals—frequently with one or a few large individuals dominating the others. Dominating individuals may suppress the growth and affect the behaviour and colouration of their companions, presumably via aggressive behaviour, especially during feeding, but also via the production of substances which act as growth inhibitors (ROSE, 1959, 1960; LAALE and MCCALLION, 1968). In the latter case, water change in closed culture systems or increased flow rates in open systems usually helps to diminish or eliminate the inhibitory effects.

In older larvae and especially in juvenile and adult fishes with territorial behaviour, the removal of the dominating individual is usually followed by significant changes in the size hierarchy. Another individual soon takes the place of the dominator, growing appreciably and displaying concurrent changes in behaviour and colouration.

In contrast to ecologically oriented research cultivation, natural behaviour is irrelevant in commercial cultivation as long as maximum population density can be combined satisfactorily with maximum growth rates and meat production. In intensive culture operations (p. 1335), selective breeding and tailor-made culture-system design, as well as reduction of aggressiveness, hold the key to economic success.

Schooling

Schooling behaviour in fishes is of considerable ecological significance. Since essential adjustments to schooling activities may occur already in larvae, we consider here larvae, juveniles and adults together.

In nature, animals may be visualized to exist as members of biological groupings. In social groups, they often maintain long-lasting active contact. Uni- or multi-specific social aggregations are an essential organizational feature of organismic existence at the supra-individual level. Schooling, a common form of social grouping in fishes, may be important for defence, feeding and reproduction, as well as for such phenomena as mutual stimulation, imprinting and learning.

The schooling behaviour of larval, juvenile and adult fishes has attracted considerable attention (e.g. BREDER, 1951, 1954, 1959, 1965, 1967; ATZ, 1953; EIBL-EIBESFELDT, 1962; SHAW, 1962, 1967; GERASIMOV, 1965; HEMMINGS, 1966; HUNTER, 1966, 1968; KÜHLMANN and KARST, 1967; SHAW and SACHS, 1967; RADA KOV, 1970; see also Volume II: TESCH, 1975). The most recent review on ecological aspects of schooling in fishes has been presented by RADA KOV (1972). His documentation is based on the behaviour of juveniles and adults. Essential aspects of schooling in fishes, as reviewed by BREDER (1959) and RADA KOV, may be summarized as follows: A school of fishes without dominance behaviour can be defined as a temporary, unstable, organized aggregation of individuals with the following characteristics: (i) usually all school members are conspecifics, mostly at the same life-cycle phase; (ii) they maintain mutual contact and communicate with each other; (iii) they exhibit, or may at any moment exhibit, coordinated activities which are, as a rule, ecologically meaningful for group members. The major functions of the school are subject to change, but at a given time only one function is

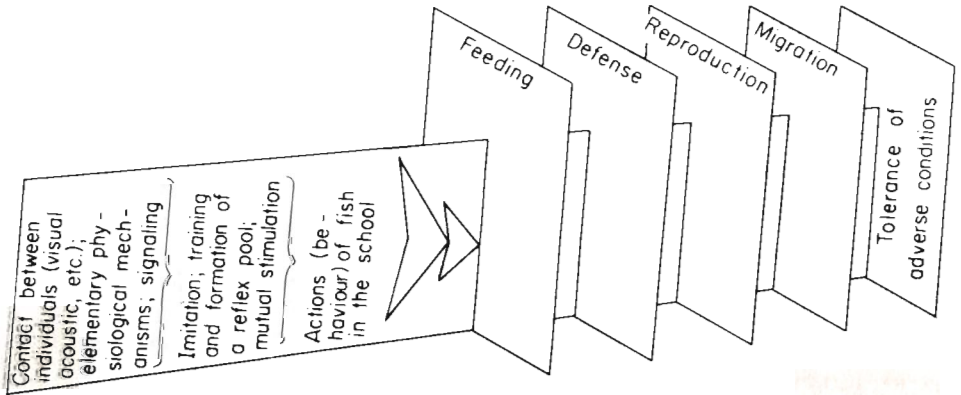

Fig. 5-103: Essential features of schooling in fishes and their ecological significance (After RADA KOV, 1972; reproduced by permission of Wiley-Interscience.)

operative, e.g. search for food, feeding, defence (escape), reproduction or migration (Fig. 5-103). Without adequate stimulation, the school tends to disperse or is not formed. A school with dominance behaviour responds similarly. While numerous animals establish dominance schooling (i.e. grouping of individuals with one or several individuals dominating over all others), non-dominance schooling has been demonstrated unequivocally only in fishes.

In non-dominance schools consisting of dozens or hundreds of individuals, 'leadership' is exercised by a large percent (e.g. 30 to 40%) of the school members (Radakov, 1972). The exchange of members—a common feature in non-dominance schools—facilitates the transfer (due to copying, imitation, training, learning) of 'foreign' conditioned reflexes. This leads to an augmentation of the total 'conditioned reflex pool' available to the school, thus increasing its potential ecological success.

For the experimental ecologist concerned with the cultivation of fishes which school in nature, it is important to provide conditions which facilitate the development of normal schooling behaviour in fish larvae, juveniles or adults. The primary

factors facilitating communication between school members—locomotory activity and visual perception—obviously require adequate illumination for proper functioning, as well as a certain minimum of space for schooling manoeuvres. During complete darkness, most fish schools disperse (RADAKOV, 1972). Reorganization of schooling patterns may also occur at very high illumination.

RADAKOV (1972) stresses the importance of learning for schooling fishes, i.e. the acquisition of reflexes from conspecifics 'by merely watching them' (copying). He points out that it is more advantageous to acquire conditioned reflexes from more experienced individuals (e.g. older conspecifics, parents) than to elaborate the reflexes on the basis of personal experience. A predator attack often ends with the death of the prey individual involved and, hence, provides no chance for reflex conditioning. Acquisition of conditioned reflexes in fishes has been demonstrated, for example, by POPOV (1953), BOGOMOLOVA and co-authors (1958), GERASIMOV (1962), GIRSA (1962) and LESHCHEVA (1968, 1970). When the school reaches a certain size in terms of individual members, the price paid for learning, e.g. the death of some members caused by predators, is probably minimal (RADAKOV, 1972).

Conditioned reflexes fade unless reinforced; hence, the school's 'reflex pool' is important; it provides a permanent source for behavioural reinforcement. Herring kept in individual isolation by GERASIMOV (1962) did not feed at all, and most individuals eventually died. However, when kept in large schools, the drive to feed was enforced through group behaviour—sometimes to such a degree that prey-catching movements were performed by some individuals without food being available to them. Isolated individuals of pollock did not feed for 10 to 20 days, whereas groups of 15 to 20 individuals began to feed within 3 to 7 days. Cod, on the other hand, become adjusted to isolation more quickly and may survive in solitude for months.

Prey catching

Towards the end of the yolk-sac stage, conditions are essential which help to attain quickly the maximum possible prey-catching success. Of particular importance are illumination, day length, food-organism motility, size and concentration.

Illumination as a factor in the environment of captive fish larvae has received little attention. Presumably, quantity, quality and the direction of light play a more important role for orientation (e.g. for prey catching, schooling, obstacle avoidance) than is generally recognized (Volume I: BLAXTER, 1970a; Volume II: TESCH, 1975). Day length is of considerable importance since it usually determines the maximum diurnal period available for food uptake. Possibly due to predator avoidance, under field conditions some forms seem to feed most actively during certain times of the day, e.g. at dusk or dawn. Captive larvae of the plaice *Paralichthys olivaceus* exhibited 3 diurnal feeding maxima; early in the morning, early in the afternoon, and early in the evening (YASUNAGA, 1971).

Prey-catching process. In *Clupea harengus* larvae, prey catching (Fig. 5-104a) comprises 7 phases: searching, body bending (S-shaped striking posture), aiming, body straightening (forward dart), mouth opening, prey securing and swallowing (BLAXTER, 1965; ROSENTHAL, 1969a). The striking posture is not always succeeded

by the subsequent catching phases; sometimes, the larva 'gives up', slowly unbending its body. Small larvae may follow a moving prey over short distances while maintaining the S-shaped posture. Apparently, the larva sights potential prey at a distance of 5 mm and makes the forward dart at a prey distance of about 2 mm. Body straightening, prey securing plus swallowing last 0.2 to 0.3 secs. Further details of prey-catching behaviour, as well as of swimming and schooling activities of herring larvae have been studied by ROSENTHAL (1968a, b) and ROSENTHAL and HEMPEL (1970).

Engraulis mordax larvae assume an S-shaped striking posture similar to that of larval clupeoids (HUNTER, 1972). Once the larva has sighted a prey, its head turns toward it until the prey is located in the centre of the larva's binocular view field.

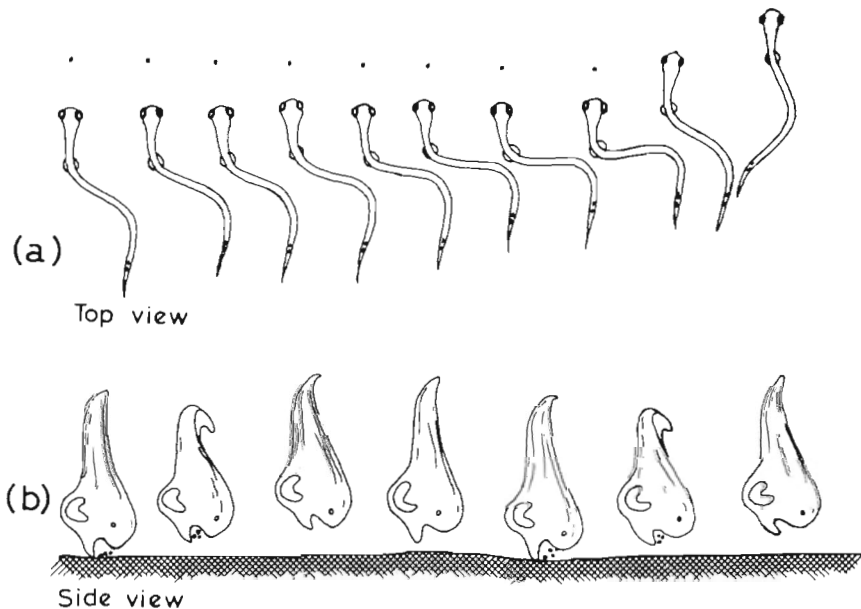

Fig. 5-104: Prey-catching behaviour of fish larvae. (a) Herring *Clupea harengus*; (b) sole *Solea solea*. (Based on ROSENTHAL, 1966, 1969a.)

Then the larva propels itself slowly toward the prey by one or more tail beats, and assumes the striking posture. Frequently, HUNTER observed swimming movements to be integrated into strike-posture formation. During body contraction, the prey is maintained directly in front of the snout. Small prey movements are compensated for by slight adjustments in head orientation, larger prey movements by rotating the entire body with the aid of the pectoral fins. The larva steadily moves toward the prey by high-frequency (50 to 60 beats sec^{-1}), low-amplitude vibrations of the fin fold or the caudal fin until striking distance is reached. The strike is prepared by drawing the tail anteriorly, and executed by jerking the tail backward and opening the mouth. Larvae of 15- to 20-mm body length are able to form the strike posture in less time than 5- to 15-mm long conspecifics; the speed of prey-catching manoeuvres increase with increasing larval size. Characteristics of larval prey-catching sequences are illustrated in Fig. 5-105.

While the S-shaped body flexure is also very prominent in planktonic larvae of the flounder *Platichthys flesus* (VON WESTERNHAGEN, personal communication), it is rare in larvae of the sole *Solea solea* (ROSENTHAL, 1966). In older captive *S. solea* larvae, the typical prey-catching behaviour when feeding on the ground (Fig.

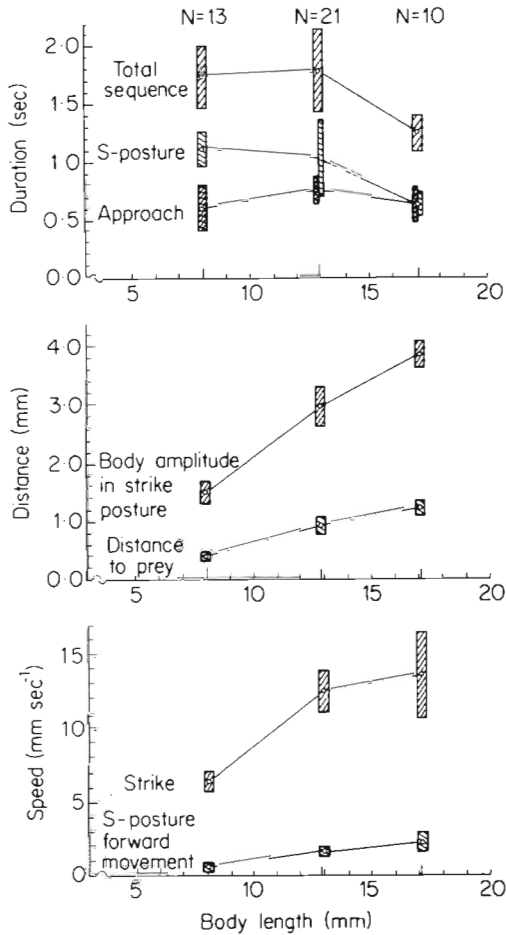

Fig. 5-105: *Engraulis mordax*. Characteristics of larval prey-catching sequences based on film analyses. Values are means $\pm 2 \times$ standard error for 3 size classes of larvae (5.1-10.0; 10.1-15.0; 15.1-20.0 mm). (After HUNTER, 1972; modified; not copyrighted.)

5-104b) consists of 7 phases: vertical movements towards the bottom (rapid, energetic spurts of swimming), bending of tail end and backing up with the aid of rapid pectoralia movements, wide-mouth opening, ramming into the bottom, probing for food, and swallowing.

Solea solea larvae begin to feed 3 or 4 days after hatching (FLÜCHTER, 1965;

ROSENTHAL, 1966). The truly pelagic phase of the larvae is quite brief and practically limited to a few days after the end of the yolk-sac stage. Planktonic prey, especially fast moving forms, may be pursued, but usually with rather limited success. Even with slow moving plankters such as nauplii of *Artemia salina*, the prey-catching success remains below 5 or 10%. Under aquarium conditions, sole larvae hunt primarily near the bottom and appear to concentrate on picking food matter directly from the substratum. This bottom-oriented behaviour seems to prevail also under *in situ* conditions.

Larvae of the garpike *Belone belone* begin to feed when less than half of their yolk is absorbed (ROSENTHAL and FONDS, 1973). The prey-catching behaviour indicates considerable flexibility of the 'prey scheme'. According to ROSENTHAL and FONDS,

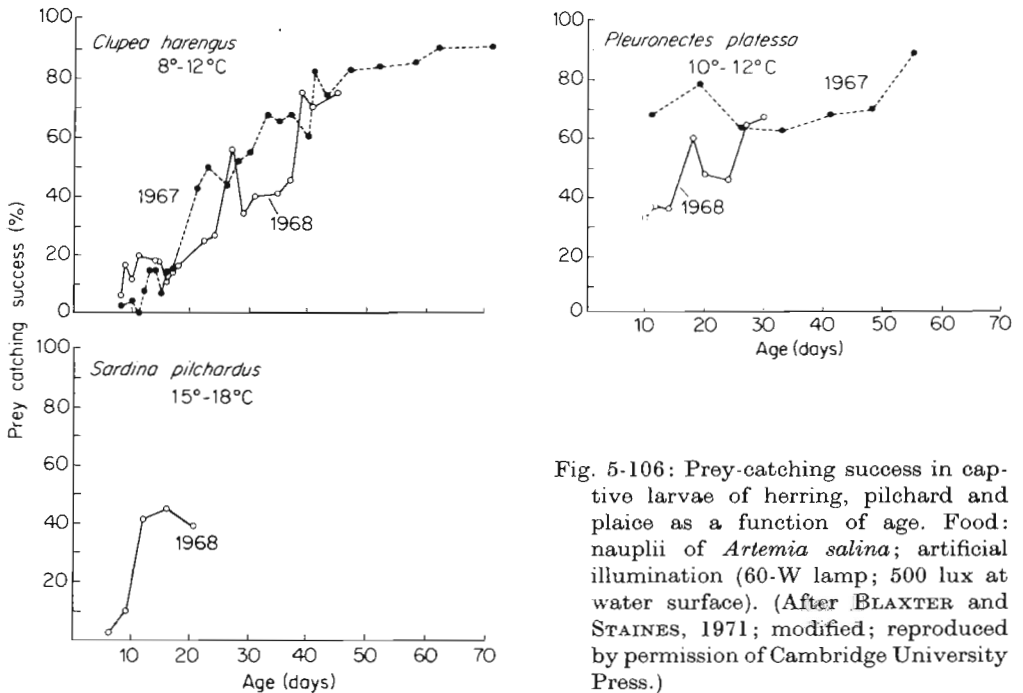

Fig. 5-106: Prey-catching success in captive larvae of herring, pilchard and plaice as a function of age. Food: nauplii of *Artemia salina*; artificial illumination (60-W lamp; 500 lux at water surface). (After BLAXTER and STAINES, 1971; modified; reproduced by permission of Cambridge University Press.)

the larvae snap at a large variety of potential food items, ranging from copepods to artificial dry food. S-shaped body flexure was rarely observed in young *B. belone*, and was usually related to relatively large prey organisms. Under conditions of crowding, aggression and cannibalism prevailed.

Prey-catching success. As has already been pointed out, the success of prey-catching manoeuvres increases with larval age. From the minimum percentage of successful prey-catching manoeuvres observed in larvae which, after yolk-sac absorption, begin to feed, the rate of success usually increases rapidly over the next few days, then more gradually, finally reaching a plateau (Fig. 5-106). In larvae of the herring *Clupea harengus*, the prey-catching success increases from an initial 1% to nearly 60% within 30 to 35 days (ROSENTHAL, 1969a). In larvae of the anchovy *Engraulis mordax*, prey-catching success increases rapidly from 11% at the age of 3 days (first day of external food uptake) to 50% at the age of 8 days (HUNTER, 1972).

Thereafter, improvements were more gradual. HUNTER has expressed the relationship between prey-capture success and larval age by the equation:

$$\% \text{ success} = 93.2 (\log \text{ age}) - 33.30.$$

Switching from one prey type to another may temporarily reduce the percentage prey-catching success. When HUNTER (1972) offered 17-day-old *Engraulis mordax* larvae nauplii of *Artemia salina* for the first time, the rate of success dropped; only after 3 days did the larvae regain their former level of performance.

Larval age affects several aspects which contribute to the rapid increase in the percentage of prey-catching success: (i) progressive morphological differentiation and specialization of the feeding apparatus and of the locomotory system; (ii) enlargement of the visual field of perception and of the striking range; (iii) increased size range of capturable prey; (iv) increased experience.

Table 5-96

Clupea harengus. Estimated distance of prey perception (in mm) of cultivated Downs larvae during resting and swimming (After ROSENTHAL and HEMPEL, 1970; reproduced by permission of Oliver & Boyd, Edinburgh)

Age (days)	Total length (mm)	Resting	Abrupt or normal swimming	Slow meandering
3-7	10	8.0	7.0	10.0
8-10	11	10.0	9.0	11.8
11-14	12	11.8	10.8	13.6
15-17	13	13.2	12.2	15.4
18-21	14	14.8	13.8	17.2
22-27	15	16.2	15.2	19.0
28-31	16	17.8	16.8	20.8
32-37	17	19.2	18.2	22.5
38-43	18	20.8	19.8	24.4
44-49	19	22.2	21.2	26.0

Prey-catching success also depends on the escape potential of the prey and on the degree of the larva's structural differentiation at first feeding. While early larvae of *Clupea harengus* exhibit an initial prey-catching success of about 1% (ROSENTHAL, 1969a), newly hatched *Belone belone* larvae are 90% successful in prey catching (VON WESTERNHAGEN, personal communication). Newly hatched *B. belone* larvae have better developed mouth parts and are also in other respects morphologically further developed than are newly hatched *C. harengus* larvae.

In general, prey-catching activity depends on the level of satiation, and on social aspects such as competition or dominance behaviour. With increasing satiation and in the presence of dominant individuals, feeding activity tends to decrease, whereas normal competition usually acts as stimulant.

Reactive perceptive field. The size of the area in which a predator reacts to a prey, i.e. the reactive perceptive field (HOLLING, 1965), has been estimated for fish larvae

by BLAXTER (1966), BRAUM (1967), ROSENTHAL and HEMPEL (1970, see Table 5-96) and HUNTER (1972); see also BLAXTER (1969a, 1970b). According to HUNTER, *Engraulis mordax* larvae (offered as prey *Brachionus plicatilis*, various veliger larvae, nauplii of *Artemia salina* and wild copepod nauplii) responded in the horizontal plane only to prey ahead of them; prey at an angle of 90° or more from the tip of the snout were not selected; most prey captured were within 60° of the snout. The reactive perceptive field in the horizontal plane was roughly circular (Fig. 5-107). In the vertical plane, the larvae responded to prey below as well as above the

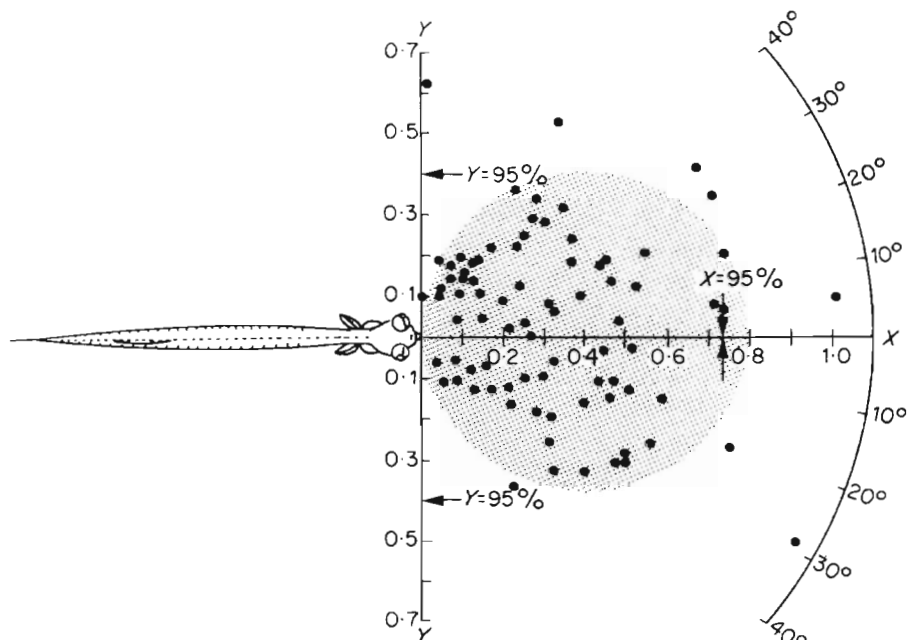

Fig. 5-107: *Engraulis mordax*. Reactive perceptive field of larvae in the horizontal plane. Points: prey position at time larvae first responded to it. Distances on X and Y axes are expressed as proportions of larval length. Arrows indicate lines that would enclose 95% of the prey organisms sighted. (After HUNTER, 1972; not copyrighted.)

x-axis; the corresponding reactive perceptive field may be roughly triangular (Fig. 5-108).

HUNTER (1972) stresses that maxima seem more appropriate than averages for assessing the extent of the reactive perceptive field, because field size may be different in different larvae and may change with feeding motivation. He sets the limits of the perceptive field to include 95% of the prey sighted. This field is elliptical and increases with larval length, having a cross section proportional to $0.45 L^2$ (L = larval body length). Only 40% of all prey-capture manoeuvres were completed. Incomplete attacks ended anywhere in the preparatory phase just before the beginning of the strike. HUNTER assumes that the principal cause of the incomplete manoeuvres was the inability of the larva to close the distance between itself and the prey.

Volume of water searched. The daily volume of water searched by a fish larva is an important measure for the larva's food-catching capacity, its quantitative nutritional requirements and its impact on the planktonic prey populations. The daily volume of water searched depends on (i) the swimming distance covered; (ii) the field of visual perception; (iii) the number of hours with illumination levels sufficient for prey perception. In *Clupea harengus* larvae, the daily volume of water searched increases from 15 to 20 l in 1-week-old larvae (end of yolk-sac stage) to about 60 to 80 l in 3-week-old larvae (ca 14 mm long). Soon after the yolk-sac stage (10 to 11 mm), the larvae can consume about 35 to 40 *Artemia salina* nauplii day⁻¹; older larvae of 13 to 14 mm length may consume 50 nauplii day⁻¹ (ROSENTHAL and HEMPEL, 1970).

For larvae of *Clupea harengus*, *Sardina pilchardus* and *Pleuronectes platessa*, BLAXTER and STAINES (1971) calculated the water volumes searched hr⁻¹ shown

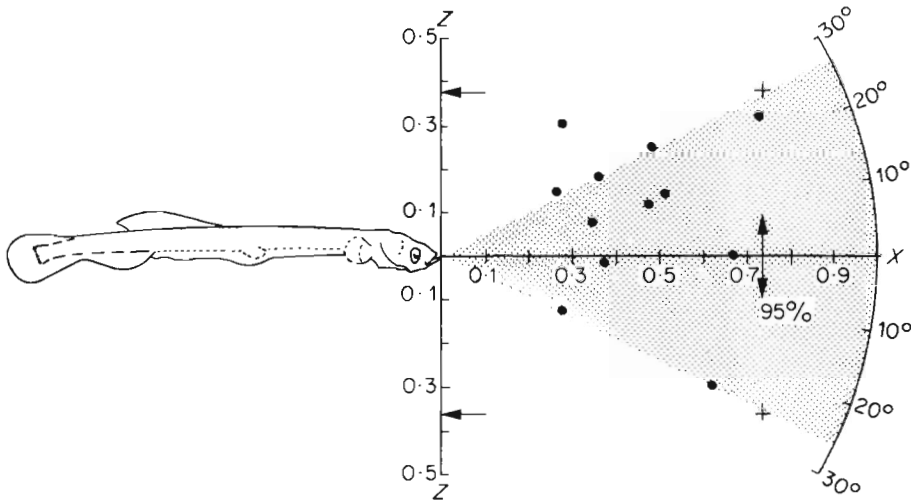

Fig. 5-108: *Engraulis mordax*. Reactive perceptive field of larvae in the vertical plane. Plus signs: points of intersection of visual cone with $Y = 95\%$; arrows on Z : projected values of Z for intersection points. Consult legend to Fig. 5-107 for further details. (After HUNTER, 1972; not copyrighted.)

in Fig. 5-109. For *Engraulis mordax* larvae, the volume of water searched hr⁻¹ at 17° to 18° C has been calculated by HUNTER (1972) who combined the estimate of the reactive perceptive field with an estimate of sustained swimming activity. When the average of the two estimates was used, the volume searched turned out to be nearly the same as the relationship:

$$\text{Number of litres searched hr}^{-1} = L^3$$

where L = larval length in cm. In Volume IV, Fig. 5-30 combines estimates of l hr⁻¹ searched by larvae of *E. mordax*, *C. harengus*, *S. pilchardus* and *P. platessa*.

Antibiotic Treatment

The use of antibiotics for combating bacterial populations which are potentially

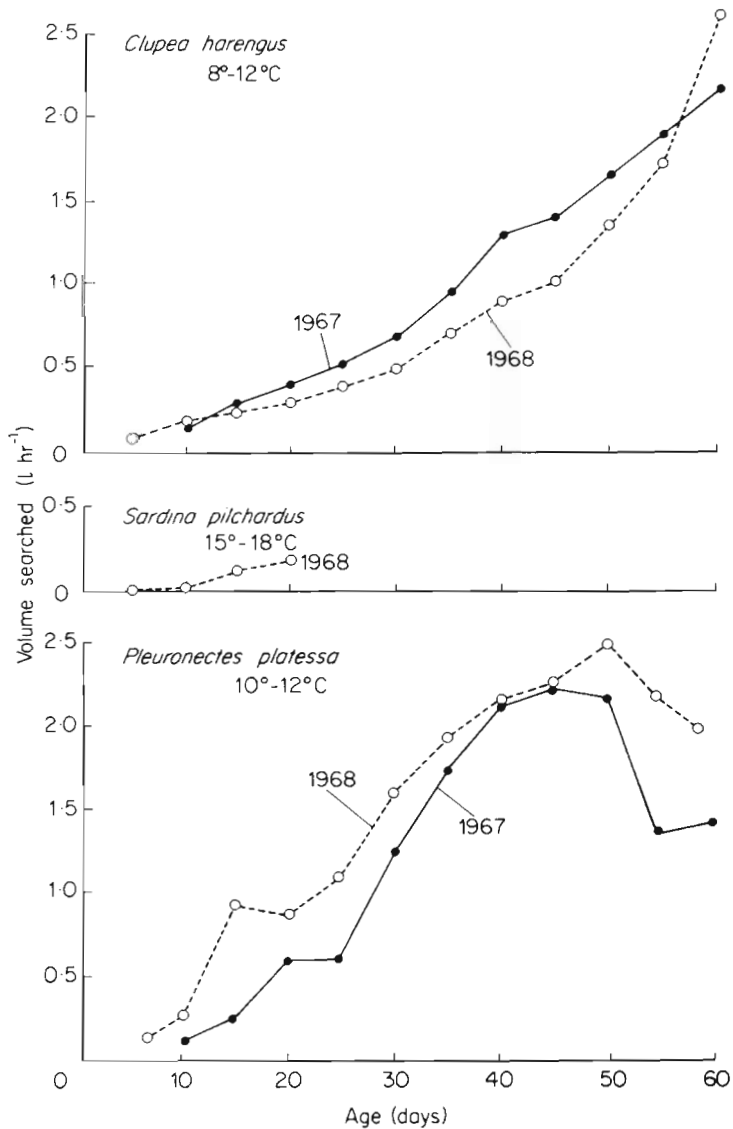

Fig. 5-109: Water volume searched by larvae of herring, pilchard and plaice as a function of age; artificial illumination (60-W lamp; 500 lux at water surface). (After BLAXTER and STAINES, 1971; modified; reproduced by permission of Cambridge University Press.)

detrimental to captive fish eggs has been inaugurated by OPPENHEIMER (1955). He showed that a mixture of penicillin and streptomycin increased the hatching percentage in eggs of *Sardinops caerulea*, *Gadus callarias* and *Pleuronichthys* sp. SHELBOURNE (1963) tested the effects of antibiotics on eggs of the plaice *Pleuronectes platessa*, as well as on the subsequent rates of hatching and on larval survival to metamorphosis. Antibiotic-treated experimentals exhibited improved rates of

Table 5-97

Antibiotics tested for their effect on bacterial growth in sea water and on survival of *Caranx mate* larvae. Antibiotics increasing hatching and larval survival are indicated by a + sign (After STRUHSACKER and co-authors, 1973; modified; reproduced by permission of Elsevier Scientific Publishing Company, Amsterdam)

Microbial Derivatives of Eubacteriales

Name of antibiotic:	Aerosporin ⁺ (Polymyxin B sulphate)	Coly-Mycin ⁺ (Polymyxin E, Colistin sulphate)
Derivation:	<i>Bacillus polymyxa</i>	<i>Aerobacillus colistinus</i>
Effect on bacteria in sea water:	Suppression of <i>Cytophaga</i> spp. No suppression of <i>Vibrio</i> spp. beyond day 4. No suppression of <i>Pseudomonas</i> spp.	Significant suppression of all bacteria for at least 5 days
Recommended concentration for larvae:	10-30 ppm	10-40 ppm
Toxic effects (mortality and/or retarded development):	Over approx. 40 ppm	Over approx. 40 ppm

Comments: Both of these antibiotics are effective in increasing hatch and survival. Together with Ilotycin (erythromycin gluceptate) and Penicillin G, these antibiotics are the most effective tested.

Microbial Derivatives of Actinomycetales

Name of antibiotic:	Chloromycetin (Chloramphenicol)	Garamycin (Gentamycin sulphate)
Derivation:	<i>Streptomyces venezuelae</i>	<i>Micromonospora</i> sp.
Effect on bacteria in sea water:	Some suppression of bacteria	No significant suppression of bacteria
Recommended concentration for larvae:	Not recommended	Not tested
Toxic effects:	Toxic at 25 and 50 ppm	Not tested

Comments: Chloromycetin may be less toxic at lower concentrations and Garamycin more effective at higher concentrations. A wider range should be tested.

Name of antibiotic:	Ilotycin ⁺ (Erythromycin gluceptate)	Kantrex (Kanamycin sulphate)
Derivation:	<i>Streptomyces erythreus</i>	<i>Streptomyces kanamyceticus</i>
Effect on bacteria in sea water:	Significant suppression of total bacteria count for 6 days at all non-toxic concentrations. All bacteria genera suppressed	No significant suppression
Recommended concentration for larvae:	10-12 ppm	Not tested
Toxic effects:	Over approx. 12 ppm	Not tested

Comments: Kantrex concentration of 15 ppm tested on sea water may be too low to affect bacteria colony count. More tests should be made. This antibiotic not tested on larvae.

Table 5-97—Continued

Name of antibiotic:	Streptomycin (Streptomycin sulphate)	Neomycin (Neomycin sulphate)
Derivation:	<i>Streptomyces griseus</i> and other <i>Streptomyces</i> spp.	<i>Streptomyces fradiae</i>
Effect on bacteria in sea water:	Some suppression of bacteria for 1 day, then same as control	Only slight suppression of bacteria
Recommended concentration for larvae:	50 ppm, but not very effective in reducing mortality	Not tested
Toxic effects:	100 ppm	Not tested
Comments: A wider range of Streptomycin should be tested, but indications are that it is relatively ineffective.		
Name of antibiotic:	Tetrex (Tetracycline HCl)	Vibramycin (Doxycycline)
Derivation:	Various <i>Streptomyces</i> spp.	Synthetic tetracycline
Effect on bacteria in sea water:	Significant suppression for 1 day, then same as control	Slight suppression for 5 days
Recommended concentration for larvae:	Not recommended	Not recommended
Toxic effects:	50 ppm	Toxic at all concentrations
Comments: Tetrex probably toxic at all concentrations.		
Microbial Derivatives of Fungi		
Name of antibiotic:	Geopen ⁺ (Disodium carbenicillin)	Penicillin G ⁺ (Potassium penicillin G)
Derivation:	Semi-synthetic penicillin	<i>Penicillium notatum</i> and other <i>Penicillium</i> spp.
Effect on bacteria in sea water:	Significant suppression of bacteria for 5 days then equal to control	Significant suppression for 2–3 days then equal to control
Recommended concentration for larvae:	10–50 ppm	50 ppm
Toxic effects:	Over approx. 50 ppm	Over approx. 60 ppm
Comments: These two penicillin derivatives, together with Polycillin N, significantly increase hatching and survival through critical period. However, they characteristically decrease bacteria count for only a short period (depending on concentration), thereafter allowing rapid increase to control level.		
Name of antibiotic:	Polycillin N ⁺ (Ampicillin trihydrate)	Keflin ⁺ (Sodium cephalothin)
Derivation:	Semi-synthetic penicillin with extended action against Gram-negative rods	<i>Cephalosporium</i> sp.

Table 5-97—Continued

Effect on bacteria in sea water:	Significant suppression for 3-4 days, then equal to control	Not tested
Recommended concentration for larvae:	10-25 ppm	50 ppm
Toxic effects:	Over approx. 50 ppm	100 ppm
<p>Comments: Further experiments should be made comparing the effectivity of Geopen, Penicillin G, and Polycillin in reducing bacterial counts and increasing hatch and survival. Presently they appear to be equally effective. Keflin at 50 ppm significantly improved hatching and survival of larvae, but an insufficient concentration range has been tested to determine optimal range and toxicity level.</p>		
<hr/>		
Chemical Anti-microbial Agents		
Name of antibiotic:	Furadantin (Nitrofurantoin)	Sulphadiazine (N'-2-pyrimidinyl-sutaniamide)
Derivation:	1-[(5-Nitrofur-furylidene)-amino]hydantoin	As above
Effect on bacteria in sea water:	No significant suppression	Actually enhanced bacterial growth (approx. 10 ⁵ times above control level)
Recommended concentration for larvae:	50 ppm	Not recommended
Toxic effects:	100 ppm	Not tested
<p>Comments: Furadantin is not as effective in increasing hatch and survival as other suitable antibiotics. However, a wider range should be tested.</p>		

hatching and larval survival as compared with the untreated controls. The pioneering studies by OPPENHEIMER and SHELBORNE were followed and corroborated by numerous later investigators. However, the role and ecological significance of antibiotics for rearing fish larvae remains to be fully investigated (see also Chapters 2 and 5.11, and other sections of the present chapter). Several freshwater culturists have employed malachite green instead of antibiotica—apparently with appreciable success (TIEWS, personal communication).

A detailed study by STRUHSACKER and co-authors (1973) on larvae of the carangid *Caranx mate* revealed that of the antibiotics tested for their effect on bacterial growth in sea water and on survival of *C. mate* larvae (Tables 5-97 and 5-98), erythromycin, penicillin and polymyxin are most effective. Maximum larval survival has been obtained with erythromycin; this antibiotic is available in an inexpensive tablet form ('Maracyn', Mardel Laboratories, USA). Streptomycin sulphate which has been used frequently in attempts to rear marine invertebrates and fish larvae, was found to be relatively ineffective in reducing bacterial numbers

or in promoting hatching and larval survival (Table 5-98). A classification of antibiotics in groups of different chemical nature and mode of action (Table 5-99) reveals that only Group 1 (polypeptides) acts on both active and resting stages of bacteria. Group 2 (penicillins and cephalosporins) is also bactericidal, but requires a longer period of contact with microbial cells to be effective. Group 3 (aminoglycosides) acts on growing bacteria. Group 4 (macrolides, tetracyclines, chloramphenicol) affects bacteria almost immediately upon contact. Group 4 is also bacteriostatic.

STRUHSAKER and co-authors (1973) stress the need for understanding the mechanisms by which antibiotics affect bacteria. Only in this way can substances be selected which act synergistically and hence, may be used in conjunction, and

Table 5-98

Caranx mate. Mean percent hatching and survival of larvae given different antibiotic treatments. Antibiotics arranged approximately in order of increasing effectiveness. One treatment on day 1 only. All percent hatches shown were statistically significantly different from controls ($P < 0.01$) except for Streptomycin (After STRUHSAKER and co-authors, 1973; reproduced by permission of Elsevier Scientific Publishing Company, Amsterdam)

Antibiotic	Concentration (ppm)	Mean percent hatching	Mean percent survival (past days 6-7)
Controls (no antibiotic)	—	67	36
Streptomycin	50	66	42
Keflin	50	74	67
Polycillin N	10-25	90	55
Penicillin G	50	85	75
Geopen	10-50	85	77
Aerosporin	10-30	87	85
Coly-Mycin	10-40	94	87
Ilotycin	10-12	94	93

substances be rejected which act antagonistically, inhibiting or cancelling each other's effects. Groups 2 and 3, the penicillins and streptomycin, are synergistic. Both act only on active, growing cells. Groups 1 and 4 may also be synergistic, if used in sequence. Antibiotics which kill bacteria immediately upon contact (polymixins) or stop bacterial growth immediately (erythromycin) are antagonistic to the antibiotics which require a certain period of contact before becoming effective (e.g. penicillins, streptomycin). Maximum control of bacteria over extended periods might be achieved by sequential antibiotic treatment (e.g. initial erythromycin treatment followed by polymixin after about 5 days).

As has already been pointed out in Chapter 2, the effects of antibiotics on cultivated marine organisms are insufficiently known. Marine ecologists, even more so than mariculturists, must keep this fact in mind when employing antibiotics. Most antibiotics presently used have been developed for disease control in man. Such antibiotics may not be the most effective ones in the marine environment. Along

Table 5-99

Group, chemical nature and mode of action of some antibiotics. +: increasing percent hatch and survival of *Caranx mate* larvae (Compiled by STRUHSAKER, and co-authors 1973; from EVANS, 1965; GALE, 1966; GOTTLIEB and SHAW, 1967; GARROD and O'GRADY, 1968)

Group and chemical nature	Non-proprietary name (with proprietary examples)	Empirical formula	Mode of action*
Polypeptides (cyclic polyamides)	Polymyxin B (Aerosporin) ⁺	C ₅₆ H ₉₈ N ₁₆ O ₁₃	1
	Polymyxin E = Colistin A (*Coly-Mycin)	C ₅₃ H ₁₀₀ N ₁₆ O ₁₃	
Penicillins and cephalosporins water-soluble acids, α- amino-β-lactams fused to sulphur-containing ring)	Benzylpenicillins (*Penicillin G)	C ₁₆ H ₁₈ N ₂ O ₄ S	2
	(*Geopen) Ampicillin (*Polycillin N)	C ₁₆ H ₁₉ N ₃ O ₄ S	
	Cephalothin (*Keflin)	C ₁₆ H ₁₆ N ₂ O ₆ S ₂	
Aminoglycosides (water-soluble bases containing amino sugars)	Streptomycin	C ₂₁ H ₃₉ N ₇ O ₁₂	3
Macrolides (large ring lactones with at least 1 sugar moiety)	Erythromycin (*Ilotycin)	C ₃₇ H ₆₇ NO ₁₃	4
Tetracyclines (amphoteric, highly substituted naphtha- cene derivatives)	Tetracycline (Tetrex)	C ₂₂ H ₂₄ N ₂ O ₈	4
	Oxytetracycline (Vibramycin)	C ₂₂ H ₂₄ N ₂ O ₈	
Miscellaneous (p-nitrophenylserinol derivative)	Chloramphenicol (Chloromycetin)	C ₁₁ H ₁₂ Cl ₂ N ₂ O ₅	4

* Classification of general modes of action:

Group 1: Surface-active agents, affecting permeability of bacterial cell membrane causing leakage of substances of small molecular weight. Bactericidal and bacteriostatic; rapidly induce cessation of bacterial respiration (especially Colistin).

Group 2: Inhibit synthesis of cell membrane during bacterial growth and hence, cause cell lysis (membrane ruptures). Require bacterial growth to act. Bactericidal; long period of contact with bacteria necessary.

Group 3: Inhibit protein synthesis. Require bacterial growth to act. Bacteriostatic; period of contact with bacteria necessary.

Group 4: Inhibit protein synthesis. Require bacterial growth to act. Bacteriostatic; act almost immediately upon contact.

Groups 2 and 3 are synergistic. Groups 1 and 4 are sequentially synergistic. Groups 1 and 4 are often antagonistic to groups 2 and 3.

with STRUHSAKER and co-authors (1973), we encourage research on antibiotics naturally occurring in oceans and coastal waters (see also Chapter 2, pp. 24, 27, 129). Antibiotic addition to fish feeds receives brief attention on p. 1008.

(c) Rearing of Juveniles and Adults

Environmental Requirements

After completion of larval development, mortalities usually drop drastically. A large number of juvenile and adult marine fishes have been kept under culture conditions without great difficulty. However, breeding has remained a rarity.

The essential environmental circumstances which are required by a given fish for growth and reproduction have still to be defined in detail for most species. Where specific information on light, temperature and salinity requirements or on water-quality criteria have become available, these usually refer to commercial rather than to ecological aspects.

In many cases, the environmental conditions which have allowed the larvae to survive and to grow are also acceptable to juveniles and adults. However, space requirements increase with size, and changes in behaviour and in environmental and nutritional demands may occur as the fish matures. The environmental conditions required for breeding usually document a high degree of species specificity. They are considered under the subheading *Gamete Maturation and Release* (p. 1020).

Several marine fishes have been grown with appreciable success in net cages or similar confinements under *quasi in situ* conditions. For commercial purposes, net-cage cultures can be considered useful only if the advantages of low facility costs supersede those obtainable under more controlled culture conditions (p. 1328).

Improvement of growth rates and conversion efficiencies in cultivated commercial fishes due to environmental control can be considerable and has recently received increased attention. BRETT and SUTHERLAND (1970), for example, have demonstrated that the growth of juvenile sockeye salmon *Oncorhynchus nerka* could be accelerated beyond that obtained under optimum thermal conditions by additional environmental manipulation. When coupled with optimum temperature, favourable photoperiod, salinity, water velocity and protection from direct light, a marked further increase in growth rate was obtained, i.e. from 1.4 to 2.4% wt day⁻¹ (BRETT and co-authors, 1969). At 15° C, in 28‰ S and under a photoperiod that increased from 15 to 18 hrs light day⁻¹, *O. nerka* and *O. gorbuscha* can be grown from a weight of 4 g to 230 g in 280 days (BRETT, 1974). The rearing of young eels *Anguilla anguilla* in a closed system has been reviewed by SELTZ (1974). More recent laboratory experiments on eels have been conducted by EDEL (1975b), HAIN (1975), KUHLMANN (1975), SCHULZ (1975) and ZIMMERMANN and McCLEAVE (1975). Application of the hormone methyltestosterone, incorporated in the diet at a concentration of 1 ppm, has accelerated growth in *Carassius auratus*, *Oncorhynchus nerka* and *Salmo gairdneri* (YAMAZAKI, 1976).

In a number of fishes, environmental factors such as water quality, temperature and nutrition, as well as crowding, have been claimed to affect sex determination

and sexual differentiation. It seems that both genetic and non-genetic factors contribute to determining the sex. Carefully conducted, critical culture experiments are necessary to explore more fully the apparently complex underlying mechanisms.

Nutritional Requirements

Our present knowledge regarding the nutritional requirements of juvenile and adult marine fishes is primarily based on (i) stomach-content analyses conducted on field-collected specimens, especially of commercially important species; (ii) experiments concerned with development of feeds which facilitate maximum growth of farmed fishes at minimum cost. Relatively few investigators have attempted to cultivate marine fishes on natural foods. Two important aspects have been rather neglected: (i) the ecological significance of specific nutritional needs; (ii) the adequacy of the fish farmed for meeting defined human nutritional requirements. Purified synthetic test diets suitable for analyzing a fish's nutritional requirements have been formulated only in very few cases. YONE and co-authors (1974), for example, developed test diets for nutritional studies on the red sea bream *Chrysophrys major*.

It is impossible to review here the literature on stomach-content analyses and on experimental feeds. Numerous pertinent papers have been considered by BARDACH and co-authors (1972) and HALVER (1972a, b). Examples of more recent accounts are those by LANDE (1973) on *Pleuronectes platessa*; ADAMS (1972) on *Lagodon rhomboides*, *Bairdiella chrysur* and *Cynoscion nebulosus*; CARR and ADAMS (1973) on a variety of estuarine fishes; CHAO (1973) on the stomachless cunner *Tautogolabrus adspersus*; TESCH (1977) on the eel *Anguilla anguilla*. Food-intake dynamics in marine fishes have been reviewed in Volume IV: CONOVER (in press).

Large amounts of natural food are often difficult to come by. Therefore, fish culturists have turned increasingly to food sources that (i) can be supplied with a high degree of reliability, (ii) consist of known ingredients and, thus, are of reproducible quality, (iii) can be stored and easily handled, and (iv) are inexpensive.

Several fish farmers have distinguished three main types of fish feed: wet feeds (wet offal) such as beef liver, fish eggs, meat of invertebrates; semi-moist feeds consisting of wet offal and dry ingredients; and dry feeds, compounded with dry components. Wet and semi-moist feeds have been found to be less successful (problems of supply, preparation and storage; lower food conversion) than dry feeds, except in cases where the fish cultivated (e.g. *Oncorhynchus* species) prefer a soft-textured diet. Good dry feeds must combine the following characteristics: (i) high protein level, except for plant feeders such as milkfish and siganids; (ii) amino-acid composition tailored to specific requirements, (iii) adequate pellet size and texture; (iv) water stability taking into account prevailing temperature and feeding behaviour. For maximum food-conversion efficiency, food ration and feeding schedule are of importance (p. 1018). The equipment used for feeding has been briefly reviewed in Chapter 2 (p. 259).

Older preparations of fish feeds have primarily relied on animal products such as blood-, meat- and bone meal, liver, spleen, lung, heart and tripe derived from oxen, sheep, horses, hogs and fishes (e.g. LAW and co-authors, 1961; SINNHUBER

and co-authors, 1961). However, with increasing knowledge on the nutritional requirements of fishes, plant products have more and more replaced animal proteins. According to FRIEDMAN and SHIBKO (1972), the plant products used include milling by-products (e.g. oat hulls, rice bran, alfalfa meal, beet pulp), oilseed meals (e.g. cottonseed, soy bean), vegetable oils (e.g. corn oil, peanut oil, safflower oil) and various other products such as yeasts, tomato pomace, carrots and paprika. Of particular importance for commercial culture operations are diets consisting primarily of minced and chopped fish.

The development of commercially available, pelleted feeds has significantly improved the efficiency for growing captive fishes. However, as many crustaceans (p. 823), many fishes grow best on food with relatively high protein contents and with an amino-acid composition similar to that of their own body. Feeding fishes with fish protein cannot, of course, augment the world protein production! Some organic materials, however, which are at present not directly usable for human food production, can be converted into fish meat. Several American scientists (for references consult BARDACH and co-authors, 1972), as well as TIEWS and co-authors (1975) of the Federal Republic of Germany, have replaced the fish protein in their test feeds by 'waste proteins' from industrial by-products such as feather meal, bone meal, blood meal or protein-containing sludge. Where lacking in the raw diets, essential amino acids or vitamins must be supplemented.

Herbivorous fishes are of special interest both in research cultivation (e.g. in food-web dynamics) and in commercial cultivation (converters of plant feeds). While most marine fishes cultivated thus far are (primarily) carnivorous, several herbivorous species have attracted considerable attention, for example, milkfish *Chanos chanos*, mullet *Mugil cephalus* and rabbitfishes of the genus *Siganus*. Young *C. chanos* feed on unicellular algae; later, they turn increasingly to larger filamentous algae. According to HIATT (1944), SCHUSTER (1960), TAMPI (1958) and VINCENCIO (1964), the natural food of fry and fingerlings consists predominantly of diatoms (e.g. species of *Chroococcus*, *Pleurosigma*, *Diploneis*, *Planktoniella*, *Navicula*, *Amphora*, *Phormidium*, *Nitzschia*, *Thalassiothrix*, *Amphipleura*), but stomach contents also included bits of blue-green algae, detritus and occasionally animals such as nematodes, cladocerans and copepods. In fish ponds, juvenile and adult *C. chanos* fed mainly on filaments of blue-green algae and on (soft or half-decayed parts of) green algae (e.g. species of *Cladophora*, *Chaetomorpha*, *Merismopedia*, *Gloeocapsa*, *Gracilaria*, *Enteromorpha*, *Ulothrix*, *Spirogyra*). 'Artificial' foods such as dehydrated egg, powdered milk, alfalfa meal, soy-bean meal and rice bran are also accepted and have yielded satisfactory growth (CARBINE, 1947; CHEN, 1950).

Of the mullets studied thus far, some have been claimed to be primarily plankton feeders (e.g. *Mugil seheli*, *M. troschellii*, *M. waigiensis*: CHIDAMBARAM and KURIYAN, 1952), but most appear to feed on benthic organisms. In general, the youngest stages are primarily carnivorous, intermediate stages omnivorous and late juveniles and adults primarily herbivorous. Stomach-content analyses of field-collected *M. cephalus* revealed the following major groups of food (SUZUKI, 1965): planktonic micro-crustaceans, benthic micro-crustaceans, diatoms and other micro-algae, sandy mud and organic particles. The youngest stages fed mainly on planktonic micro-crustaceans, gradually turned to benthic animals and plants, and finally lived

essentially on micro-algae and organic particles. EGUSA (1950) found primarily amphipods and harpacticoid copepods in young stages of *M. cephalus*, and diatoms and cyanophyceans in older juveniles. A brood stock of *M. cephalus*, maintained by SHEHADEH and co-authors (1973d) in two rubber-lined outdoor ponds with circulating sea water, was sustained on diatoms (species of *Achnanthes*, *Amphiphora*, *Navicula*, *Nitzschia*, *Thalassionema*, *Thalassiosira*) and algae (*Cladophora*, *Enteromorpha*, *Lyngbya*), supplemented by Purina Trout Chow (2% fish biomass day⁻¹). Stomachs of field-collected *M. auratus*, *M. capito* and *M. saliens* in the size range 15 to 20 mm contained exclusively animals; from 20 to 55 mm, they contained plants or plants plus animals, and, above 55 mm, they contained exclusively plants (ALBERTINI-BERHAUT, 1974). The stomachs of juvenile and adult *M. parsia* and *M. speigleri* contained decayed organic matter, benthic algae (Chlorophyceae, Myxophyceae) and benthic diatoms as well as miscellaneous food materials of animal origin, mainly copepods and annelids, and sand grains (SAROJINI, 1954).

Rabbitfishes feed on almost any plant they can bite, e.g. *Siganus* (syn. *Amphacanthus*) *argenteus*, *S. canaliculatus*, *S. rostratus*, *S. rivulatus* and *S. spinus* (BENTUVIA and co-authors, 1973; TSUDA and BRYAN, 1973; VON WESTERNHAGEN, 1973c; BRYAN, 1974, 1975; TSUDA and co-authors, 1974). Food-preference studies by VON WESTERNHAGEN (1973a, b, 1974a) on *S. guttatus*, *S. canaliculatus*, *S. spinus* and *S. virgatus* reared in tanks revealed that out of 101 different algae and 4 vascular plants, members of 67 species were eaten. Out of 23 algae, the highest selectivity indices could be attributed to *Enteromorpha intestinalis*, *Gracilaria confervoides* and *G. cylindrica*. Rabbitfishes have been cultivated by several investigators. MANACOP (1937) and FUJITA and UENO (1954) employed artificial insemination in *S. (Amphacanthus) canaliculatus* and *S. fuscescens*, respectively; POPPER and co-authors (1973) fertilized and hatched eggs from ripe, wild *S. rivulatus*; SOH and LAM (1973) and VON WESTERNHAGEN and ROSENTHAL (1975) were able to induce gamete maturation in *S. canaliculatus*, and MAY and co-authors (1974) succeeded in spawning wild catches of *S. canaliculatus* and in rearing the larvae hatched to metamorphosis on a diet of *Brachionus plicatilis* (p. 679) and *Artemia salina* (p. 743).

The rabbitfishes *Siganus canaliculatus* and *S. guttatus* have been reared on an artificial diet from juveniles to adults by VON WESTERNHAGEN and ROSENTHAL (1975) in a closed sea-water system: 1500 l capacity (14-hr photoperiod; 40-W fluorescent lamps 15 cm above tanks; 26° to 30° C; 32.2‰ S; pH 7.7 to 8.1; biological sand-gravel-oyster shell grit filter; ozonizer; foam separator). The culture enclosures were either black conical troughs (85 l capacity; ca 60 cm diameter; 35 cm deep) or shallow pans (120 l capacity; 90 × 90 × 18 cm deep). Water-flow rate approximated 2.0 l min⁻¹. The dissolved oxygen level was maintained at 70% saturation. After feeding the rabbitfishes pieces of *Enteromorpha* sp.—a diet which is readily devoured, but nutritionally inadequate (VON WESTERNHAGEN, 1974b)—pelleted, commercial low-protein chicken and rabbit feeds were offered (Table 5-100). The pellets disintegrated within 2 to 3 mins after immersion, and the fish fed voraciously on the crumbling pellet parts. While the fish grew well on both pelleted diets, rabbit feed supported better growth. Within 6 months, juvenile *S. canaliculatus* (4 to 6 cm, 2 to 6 g) reached sexual maturity (12 cm, 20 g).

Diets composed of completely digestible and assimilable matter are considered undesirable by many fish culturists. Certain amounts of non-assimilable matter

improve digestion and protein conversion, especially in herbivores, and may be necessary for proper excretory functions. Detailed studies on optimum relationships between assimilable and non-assimilable substances, as well as on the nature of the non-assimilable matter that can best be used in artificial diets, remain to be conducted. Many substances in fish diets are considered 'unnecessary, undesirable, detrimental or even toxic.' The 'bewildering array' of the numerous non-nutrient diet components has been reviewed by FRIEDMAN and SHIBKO (1972).

While addition of antibiotics to fish feeds has been shown to be beneficial in

Table 5-100

Pelleted feeds (chicken and rabbit feeds*) used for sustaining the rabbitfishes *Siganus canaliculatus* and *S. guttatus*. Main composition in percent. I.U. = international units (After VON WESTERNHAGEN and ROSENTHAL, 1975; reproduced by permission of Biologische Anstalt Helgoland)

Component	Chicken feeds	Rabbit feeds
Ground corn	55.0	—
Wheat meal	10.7	—
Wheat bran	7.0	12.5
Lucerne-grass meal	7.0	25.0
Tapioca meal	5.0	—
Fish meal	1.0	—
Ground oats	—	15.0
Bruised soy beans	2.0	3.0
Animal protein	0.5	—
Molasses	2.0	6.0
Bone meal	2.0	1.0
Dry fibre chips	—	13.0
Corn gluten	—	14.0
Calcium carbonate	1.0	—
Vitamine A (I.U. kg ⁻¹)	6000	6000
Vitamine D ₃ (I.U. kg ⁻¹)	750	750

* Manufacturer: W. Ströh jun. K.G., 2409 Hobbbersdorf, FRG.

combating diseases due to microbial agents (e.g. WAGNER, 1954; SCHÄPERCLAUS, 1954, 1961; SNIESZKO, 1957; MANN, 1964, 1967a, b, 1968, 1973; BANK, 1967; REICHENBACH-KLINKE and OLLENSCHLÄGER, 1972), the biological effects of such supplementations remain to be fully explored. Even in cases where the antibiotics do not interfere with growth and food conversion, they may, conceivably, reduce natural disease resistance and affect life-supporting activities of non-pathogenic bacteria. A final judgement on the pros and cons of 'antibiotica feeds' and the addition of other remedies (e.g. MANN, 1973) is not yet possible.

Dietary composition

The dietary composition of foods that have been offered to marine fishes is largely based on ingredients of commercial feeds developed for catfish, carp,

salmon and trout. For details consult ALBRECHT and BREITSPRECHER (1969), BARDACH and co-authors (1972) and HALVER (1972a, b).

An example of basic dietary data established for ictalurid catfish is presented in Table 5-101. Formula and ingredient specifications for salmon diet are listed in

Table 5-101

Example of basic dietary data established for ictalurid catfish (Compiled from data presented in BARDACH and co-authors, 1972)

Nutritional requirements		General feed formulation	
Component	Amount	Component	Amount (%)
Protein	Min 32%	Grain by-products	45
Crude fat	Min 4%	Protein concentrates	45
	Max 8%	Dehydrated alfalfa	4
Crude fibre	Min 8%	Distiller's dry solubles	5
	Max 20%	Mineralized salt	1
Fish meal	Min 8%		
Calories	Min 540 kg ⁻¹		
Protein calories	Min 243 kg ⁻¹		
Calcium	Min 1%		
Phosphorus	Min 1%		

Computer-derived feed formula		Formula for pelleted feed	
Component	Amount (%)	Component	Amount (%)
Fish meal (menhaden)	13.7	Soy-bean oil meal (44% protein)	35
Soy-bean meal (solvent, dehulled)	22.0	Peanut cake (53% protein)	35
Meat scraps	0.6	Fish meal (60% protein)	15
Feather meal	6.4	Distiller's dry solubles (24% protein)	14
Blood meal	1.3	Bentonite clay (binding material)	1
Alfalfa meal (required)	5.0		
Rice bran	42.1		
Rice hull fractions	7.9		
Vitamin premix (required)	1.0		

Vitamin premix		Rations	
Compound	Amount	Body weight (kg)	Feed day ⁻¹ (kg)
Vitamin A	450,000 USP units	4.5	0.45
Vitamin D ₃	200,000 IC	9.0	0.54
Riboflavin	300 mg	14.4	0.94
Pantothenic acid	600 mg	27.0	1.44
Niacin	3,500 mg	41.8	2.30
Choline chloride	40,000 mg	50.4	2.70
Vitamin B ₁₂	1 mg	81.0	4.14
Vitamin E	150 I.U.	147.6	5.40
Vitamin K (menadione sodium bisulphite)	100 mg	197.5	7.20
Ethoxyquin (antioxidant)	6.5 g	229.1	9.00
Folic acid	40 mg	295.2	11.25
		382.5 and over	13.50

Tables 5-102 to 5-104. Cultivated adult puffers *Fugu rubripes* and *F. vermicularis* have been sustained on fresh trash fish such as horse mackerel, anchovies and sand eels. For eels, the feed listed in Table 5-105 has proved successful in Taiwan. Details regarding preparation, evaluation and processing of commercial fish feeds have been reviewed by SCHÄPERCLAUS (1933), WOOD (1953), LIN (1959), HUET (1970) and HASTINGS and DICKIE (1972). A recent review of calorific and energetic requirements of fishes has been presented by PHILLIPS (1972).

Table 5-102

Formula and ingredient specifications for the Oregon moist-pellet salmon diet
(Data presented in BARDACH and co-authors, 1972; modified)

Component	Amount (%)	Specifications
Meal mix		
Herring meal	28.0	Minimum 70% protein; full meal, containing the herring solubles
Cottonseed meal	15.0	Prepressed, solvent extracted, not more than 0.04% free gossypol; minimum protein: 50%
Dried whey-product	5.0	Foremost MNC or equivalent
Shrimp or crab meal (preferably shrimp)	4.0	Maximum 3% salt (NaCl), crab meal to contain minimum 30% protein
Wheat-germ meal	4.0	Minimum 25% protein and 7% fat
Corn distiller's dried solubles	4.0	
Vitamin premix	1.5	See Table 5-104
Wet mix: Two or more of the following 6 fish products, provided that none shall exceed 15% of the total diet	30.0	
<i>Thunnus alalunga</i>		Without heads and gills, with livers
<i>Atheresthes stomias</i>		Whole
Salmon		Without heads and gills, with livers, pasteurized
<i>Clupea pallasii</i>		Whole, pasteurized
<i>Squalus acanthias</i> *†		Whole, with livers
<i>Merluccius productus</i> *‡		Whole, pasteurized
Kelp meal	2.0	Algit
Soy-bean or herring oil	6.0††	Stabilized with 0.333% BHA-BHT (1:1); soy-bean oil to be fully refined; herring oil to contain less than 5 ppm DDT (including analogs), less than 2% free fatty acids, and not to be alkaline reprocessed
Choline chloride	0.5	Liquid, 70% product
Total: 100.0		

* Not to be used in 1/32- or 3/64-inch pellets.

† Delete 0.3 parts oil for every 10 parts dogfish in total diet.

‡ Add 0.5 additional parts oil for every 10 parts hake in total diet.

Table 5-103

Formula for 'Oregon starter mash' salmon fry diet; ingredient specifications as in Table 5-102 (Data presented in BARDACH and co-authors, 1972)

Component	Amount (%)
Meal mix	
Herring meal	46.0
Wheat germ meal	10.0
Dried whey-product (MNC)	10.0
Corn distiller's dried solubles	4.0
Vitamin mix	1.5
Wet mix	
Albacore tuna viscera	8.0
Turbot, salmon viscera, or herring	8.0
Kelp meal (Algit)	2.0
Soy-bean or herring oil*	10.0
Choline chloride	0.5
Total: 100.0	

* To contain 0.333% BHA-BHT (1:1).

Table 5-104

Oregon vitamin premix for salmon diets; I.U.: International Units (Data presented in BARDACH and co-authors, 1972)

Component	Guaranteed minimum analysis per pound	Source limitation
Ascorbic acid	27.0 g	
Biotin	18.0 mg	
B ₁₂	1.8 mg	
E	15,200.0 I.U.	Water dispersible, alpha-tocopherol acetate
Folic acid	215.0 mg	Not zinc folate
Inositol	17.0 g	Not phytate
Menadione	180.0 mg*	Menadione sodium bisulphite complex or menadione dimethylpyrimidinol bisulphite
Niacin	5.7 g	
d-Pantothenic acid	3.2 g	Calcium pantothenate or choline pantothenate
Pyridoxine	535.0 mg	
Riboflavin	1.6 g	
Thiamine	715.0 mg	

* The biological activity of 180 mg of menadione is required.

Table 5-105
Eel feed used in Taiwan (Data presented in BARDACH and co-authors, 1972)

Component	Amount (%)	Result of chemical analysis	Amount (%)
Fish meal	65.00	Crude protein	51.91
Defatted soy-bean meal	10.16	Crude fat	5.36
Yeast powder	10.12	Crude carbohydrate	16.03
Fish concentrate	5.00	Ash	17.97
Starch	8.12	Moisture	8.73
Multivitamins	1.00		
Lysine	0.20		
Antioxidant	0.20		
Binding substance	0.20		

A test diet for salmon, trout and related fishes (Table 5-106) has been formulated by HALVER (1966, 1970) and used for analyzing vitamin requirements. Modifying HALVER's test diet for salmonids, YONE and co-authors (1974) formulated a purified test diet for red sea bream *Chrysophrys major* fingerlings. Their results may be

Table 5-106
Water-soluble test diet developed for salmon and trout (After HALVER, 1972b; reproduced by permission of Academic Press)

Complete test diet (g)	Vitamin mix (mg)	Mineral mix (mg)			
Vitamin-free casein	38	Thiamine .HCl	5	USP XII No. 2	plus
Gelatin	12	Riboflavin	20	AlCl ₃	15
Corn oil	6	Pyridoxine .HCl	5	ZnSO ₄	300
Cod-liver oil	3	Choline chloride	500	CuCl	10
White dextrin	28	Nicotinic acid	75	MnSO ₄	80
α -Cellulose mixture†	9	Calcium pantothenate	50	KI	15
α -Cellulose	8	Inositol	200	CoCl ₂	100
Vitamins	1	Biotin	0.5	per 100 g of salt mixture	
	9	Folic acid	1.5		
Mineral mix	4	L-Ascorbic acid	100		
Water	200	Vitamin B ₁₂ §	0.01		
Total diet as fed	300	Menadione (K)	4		
		α -Tocopherol‡	40		
		acetate (E)			

* Diet preparation: Dissolve gelatin in cold water. Heat with stirring on water bath to 80°C. Remove from heat. Add with stirring—dextrin, casein, minerals, oils, and vitamins as temperature decreases. Mix well to 40°C. Pour into containers; move to refrigerator to harden. Remove from trays and store in sealed containers in refrigerator until used. Consistency of diet adjusted by amount of water in final mix and length and strength of beating.

† Delete 2 parts α -cellulose and add 2 parts CMC for preliminary feeding.

‡ Dissolve α -tocopherol in oil mix.

§ Add vitamin B₁₂ in water during final mixing.

summarized as follows: (i) Addition of L-phenylalanine and L-aspartic acid rendered HALVER's test diet acceptable to the taste of *C. major*. (ii) Growth and feeding efficiency were higher with beef liver than with jack mackerel. (iii) Best growth and feed efficiency were obtained when the dietary protein level was raised to 680 mg%. (iv) For nutritional studies, a purified test diet (YR-4) has been developed which consists of casein, 54 mg%; gelatin, 12 mg%; pollack residual oil, 9 mg%; dextrin, 8 mg%; vitamin mixture with α -cellulose, 5 mg%; mineral mixture, MP-2 formulated by the authors, 8 mg%; L-arginine, 1.5 mg%; L-tryptophan, 0.2 mg%; L-phenylalanine, 0.6 mg%; L-aspartic acid, 1.0 mg%; L-valine, 0.7 mg%; and water, 200 mg%.

Protein and amino acids. For most marine fishes, absolute protein and amino-acid requirements have still to be determined. As in other animal groups, we may expect a degree of general uniformity, but also differences, especially between carnivores and herbivores. Details are likely to vary with genotype, age, physiological condition, food ration and environmental factors, especially temperature.

The protein requirements of fishes are high—usually higher than in man or in domestic warm-blooded animals. In most marine fishes examined thus far, protein is the largest dietary constituent. Using the amino-acid pattern of whole egg protein, DELONG and co-authors (1958) report that fingerling chinook salmon *Oncorhynchus tshawytscha* offered an unrestricted food supply grow most quickly at protein levels of 40% at 8.3° C and of 55% at 14.4° C. At 20.6° and 24.4° C, fingerling ictalurid catfish require a minimum protein level of 40% (DUPREE and SNEED, 1966). At 15° C, O-group plaice *Pleuronectes platessa* exhibit linearly increasing growth rates as the protein content of their diet is increased to the maximum level offered: 70% of the dry diet (COWEY and co-authors, 1970b; see also 1970a). At 20° C, *Mugil auratus* and *M. capito* (standard length: 21 cm) show highest growth rates when offered a diet with 70% protein content, the maximum protein level offered (VALLET and co-authors, 1970); however, as soon as the natural change in diet preference occurs (15- to 40-mm individuals are largely carnivorous; larger ones are primarily herbivorous and detritivorous), lower protein percentages are sufficient. At temperatures ranging from 4° to 22° C, cage-reared rainbow trout *Salmo gairdneri* kept in 13 to 20‰S grow best at protein (fish crude protein) levels of 46% (TIEWS, personal communication). In *S. gairdneri* fingerlings, maximum growth was obtained at the highest dietary protein level offered, 50%. According to SATIA (1974), protein requirements decreased below this level after 6 to 8 weeks (Fig. 5-110).

In addition to temperature, salinity may also affect the protein requirements of fishes. Thus, ZEITOUN and co-authors (1973) have shown that the protein requirements of salmonids increase with salinity. In *Salmo gairdneri*, the protein requirement is 40% at 10‰S, but 45% at 20‰S. Comparable responses have been obtained for *Oncorhynchus kisutch* (ZEITOUN and co-authors, 1974). Gilthead bream *Chrysophrys aurata* exhibited most favourable food-conversion rates when offered a diet containing 60% protein (SABAUT and LUQUET, 1973). The less protein the diet contained, the more feed the fish consumed. However, the less protein in the diets, the better was the protein efficiency for weight gain and body protein retention. Growth rates were proportional to dietary protein content up to an incorporation

rate of 40%. Beyond this value, no significant differences in final average individual weight were recorded. The 40%-protein requirement of *C. aurata* compares well with that of other fishes examined thus far. These and most other values reported for fishes exceed the protein requirements of warm-blooded animals such as rat and pig by 2 to 5 times.

In order to assess the protein requirements more closely, it is necessary to determine those amino acids which cannot be synthesized by the test fish, i.e. to establish absolute amino-acid requirements. For such analysis, defined diets must be used. Thus far it has not been easy to develop defined diets fully acceptable to marine fishes. For determining the essential amino acids required by *Pleuronectes platessa* and *Solea solea*, COWEY and co-authors (1970a) have, therefore, used an

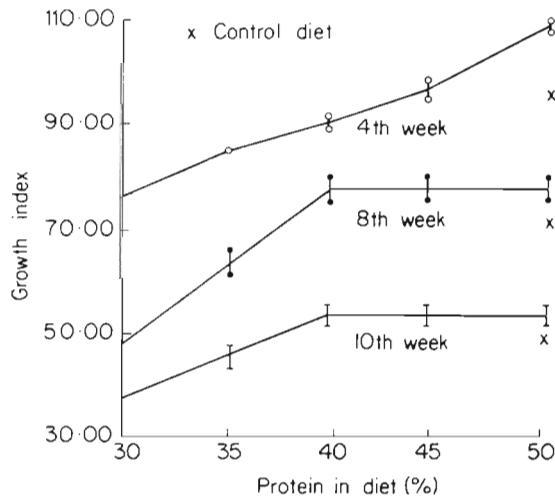

Fig. 5-110: *Salmo gairdneri*. Growth of fingerlings at different protein ($N \times 6.25$) levels. Diets were approximately isocaloric and fish were pair fed for 10 weeks at 16° to 27° C. Protein requirements shift from 50 to 40% after 8 weeks. (After SATIA, 1974; modified; not copyrighted.)

indirect approach: They administered O-group individuals of 2 to 3 g wet weight each an intraperitoneal injection of [$U-^{14}C$] glucose. Assuming that a significant amount of radioactive carbon will be incorporated only into substances which the fish can synthesize itself, amino acids recovered from sacrificed individuals containing radioactivity are considered non-essential, while those without radioactivity are identified as being essential (absolute requirement). It was inferred (Table 5-107) that *P. platessa* and *S. solea* cannot synthesize arginine, methionine, valine, threonine, isoleucine, leucine, lysine, histidine and phenylalanine from ordinarily available food materials. Radioactive carbon was incorporated into aspartic and glutamic acids, as well as into cysteine, serine, glycine, alanine and proline. Presumably, these amino acids represent non-essential dietary constituents. Radioactive carbon from the glucose was not incorporated into tyrosine. COWEY and co-authors assume that tyrosine is derived solely by the hydroxylation of

ingested phenylalanine. The amino-acid requirements of plaice and sole are similar to those of Pacific salmon (Table 5-107; see also COWEY and co-authors, 1971). Amino-acid requirements for *Anguilla anguilla* and *A. japonica* have been determined by HASHIMOTO and co-authors (1972).

The quantitative amino-acid requirements of *Oncorhynchus tshawytscha* have been reviewed by MERTZ (1972) who concludes that: (i) *O. tshawytscha* appears to

Table 5-107

Distribution of radioactivity in amino acids of protein residue from plaice *Pleuronectes platessa* and sole *Solea solea*, and amino-acid requirements in Pacific salmon *Oncorhynchus* spp. (After COWEY and co-authors, 1970a; modified; reproduced by permission of Marine Biological Association of the U.K.)

Amino acid	Amount c.p.m. (μ mole carbon) ⁻¹		Requirement in Pacific salmon*
	Plaice	Sole	
Aspartic acid	17.5	18.5	—
Cysteic acid	16.0	19.0	—
Alanine	28.4	35.0	—
Glutamic acid	17.6	17.6	—
Serine	26.2	30.0	—
Glycine	28.1	25.0	—
Proline	4.1	3.2	—
Tyrosine	0.3	0.2	—
Arginine	0.5	0.9	+
Methionine	0.2	0.6	+
Valine	0	0.3	+
Threonine	0.1	0.5	+
Isoleucine	0.1	0.2	+
Leucine	0	0	+
Lysine	0	0.1	+
Histidine	0	0	+
Phenylalanine	0	0	+
Tryptophan†			+

* Data of HALVER and co-authors (1957).

† Tryptophan is destroyed during acid hydrolysis of proteins.

be unable to use urea and diammonium citrate as precursors of dispensable amino acids (rats, pigs and humans can make efficient use of these nitrogen sources). (ii) It resembles young, domestic, warm-blooded animals in its total inability to synthesize 9 essential amino acids. (iii) It resembles the chick in its total inability to synthesize arginine. (iv) It can use arginine and, to a lesser extent, glycine as nitrogen sources for the synthesis of dispensable amino acids. (v) When the requirements for the essential amino acids are expressed as a percentage of the dietary protein, a similarity becomes apparent between *O. tshawytscha* and warm-blooded animals (see also HALVER, 1976).

Carbohydrates and fats. The studies this far conducted on carbohydrate and fat requirements of cultivated fishes do not yet provide a platform sufficiently solid for generalization. The present status of our knowledge has been reviewed by HASHIMOTO (1972), PHILLIPS, A. M. (1972), HALVER (1976) and COWEY (1976). FATS are readily digested and constitute an important source of energy. Most of the fishes hitherto examined can utilize some 20 to 30% of the dry-diet ingredients as fat, provided adequate amounts of choline, methionine and tocopherol are administered. LEE and SINNHUBER (1972) stress the practical importance of the discovery that feeds used for rainbow trout *Salmo gairdneri* consist chiefly of vegetable products with little regard for linolenic acid. Several fishes exhibit absolute requirements for fatty acids. Although linolenic acid may satisfy basic growth requirements, more polyunsaturated and longer-chain fatty acids of the C₂₂ and C₂₄ omega-3 type are essential for maximum growth rates and high growth efficiencies. The turbot *Scophthalmus maximus*, for example, requires long-chain fatty acids of the omega-3 series in its diet since it cannot chain C₁₈ acids at appreciable rates (COWEY, 1976).

The role of lipids in fish nutrition remains to be explored. In general, lipids serve as sources of energy and of essential cells structures. Lipids such as lecithin—an important structural component of cell membranes—and cephalin bind water-soluble compounds, including proteins, to lipid-soluble substances. Lecithin acts as communicator between water and lipid phases in and outside the cell and participates in enzyme functions. In view of the central role of the fatty-acid components of neutral lipids in energy liberation, and the fact that lipids are usually associated with cell proteins, the status of lipids in fish nutrition deserves more attention than hitherto received.

Minerals and vitamins. The mineral requirements of fishes are insufficiently known. In commercial fish feeds, major minerals such as calcium and phosphorus and the trace elements iron, copper, cobalt, manganese, magnesium and iodine are added to exclude potential deficiencies. Salt-water fishes seem to suffer less often from mineral deficiencies than freshwater forms. The analysis of mineral requirements is complicated by the complex interrelationships between several dietary minerals. According to COWEY (1976), dietary magnesium deficiency (4 mg Mg 100 g⁻¹ diet) leads to renal calcification in *Salmo gairdneri* at dietary calcium levels of 2.7 g 100 g⁻¹ (Ca:P ratio 1:1). However, elevation of dietary Mg to 100 mg 100 g⁻¹ diet eliminates pathological responses and restores growth rate. A specific trace-mineral deficiency was documented as early as 1914 by GAYLORD and co-authors who raised *Salvelinus fontinalis* on diets deficient in iodide. Requirements for trace minerals, which are important for enzymatic functions, have remained largely uninvestigated. For details on osmoregulation and ion regulation consult Volume I, Chapter 4.

Some limnic or brackish fishes grow faster if cultivated in salinities which exceed those prevailing in their natural habitat. CANAGARATNAM (1959) and OTTO (1971), for example, report that underyearling *Oncorhynchus kisutch* grow fastest in salinities between 5 and 12‰ (see also Volume I). In this context, the salt load of feeds may be of importance. Encountering less need for osmoregulatory work, fishes exposed to supranormal salinities may thrive better when the mineral content

in their diets is reduced. In fresh water, fry of *O. kisutch* exhibited diminished growth rates and food-conversion efficiencies when offered dietary sodium-chloride levels only slightly in excess of those in some commercial feed pellets (ZAUGG and MCLAIN, 1969). However, Atlantic salmon *Salmo salar* have been shown to grow almost equally well in 0.1, 10 and 20‰S (SHAW and co-authors, 1975b); and in fresh water or sea water, growth rate and conversion efficiency were not demonstrably affected by varying the level of dietary sodium chloride (SHAW and co-authors, 1975a). Even large dietary salt loads were almost completely absorbed from the gastrointestinal tracts within 24 hrs. In an attempt to provide an explanation, the authors pointed out that normal renal function in fresh water results in large amounts of hypoosmotic urine in which excess sodium chloride may be discharged without great energy expenditure. In sea water, however, where urine flow is minimal, excess electrolytes are primarily excreted across the gills, a process requiring extra energy. The information at hand is insufficient for evaluating the significance of dietary sodium; the role of feed minerals in salinity-dependent growth performance remains to be explored more fully. ARAI and co-authors (1975) report that supplemental mineral mixtures were effective in improving (better growth) the white-fish-meal diet offered to captive eels *Anguilla japonica*.

Most fishes have relatively high vitamin requirements. Many commercially cultured forms require the fat-soluble vitamins A, D, E and K and the water-soluble B and C vitamins. Our present knowledge on vitamin requirements of fishes is largely based on salmon, trout, carp and catfish. A review on the subject has been presented by HALVER (1972b) who discusses the importance of 4 fat-soluble and 13 water-soluble vitamins for commercial fish cultivation. The information available is summarized in Tables 5-108 and 5-109. Vitamin-deficiency diseases of fishes have received attention from SNIESZKO (1972; see also ASHLEY, 1972) and in Chapter 9. HASHIMOTO and co-authors (1970) induced thiamine-deficiency symptoms in captive eels *Anguilla japonica*.

Mortality in cultivated *Clupea harengus* due to vitamin B deficiency was successfully reduced with yeast extract ('Marmite') plus added vitamin B₆ (BLAXTER and co-authors, 1974). The dietary supplementation comprised, in terms of kg wet weight of fish day⁻¹: Riboflavin, 0.21 mg; Niacin, 2.33 mg; Pyridoxine (B₆), 0.6 mg.

In formulating allowances for water-soluble vitamins, it is essential to provide an adequate safety factor in the diet (COWEY, 1976). Pathologies due to excess intake of water soluble vitamins are not known.

Erythrocyte transketolase activity can provide a nutritional index of the thiamine status in the turbot *Scophthalmus maximus* (COWEY and co-authors, 1975; COWEY, 1976). This enzyme is saturated with coenzyme (thiamine pyrophosphate) at a dietary thiamine level of 2.6 mg kg⁻¹; the extent to which erythrocyte transketolase is saturated with thiamine pyrophosphate serves as a specific and sensitive criterion.

After formulating a purified test diet (RY-1) for nutritional studies on the red sea bream *Chrysophrys major* (YONE and co-authors, 1974; see also p. 1012), requirements for water-soluble vitamins have been analyzed by YONE and FUJII (1974). *C. major* exhibited poor growth and loss of appetite when offered diets deficient in vitamin B₆, choline, pantothenic acid, B₁₂, inositol, nicotinic acid, B₂,

B₁ and C. Deficiency of pantothenic acid and choline finally resulted in high mortalities. However, dietary deficiencies in biotin, folic acid and *p*-aminobenzoic acid did not cause marked symptoms.

Table 5-108

Deficiency symptoms due to water-soluble vitamins (Compiled by HASHIMOTO, 1972, from the sources indicated)

Vitamin	Chinook salmon (HALVER, 1957)	Carp (AOE and co-authors, 1970; OGINO and co-authors, 1970)	Channel catfish (DUPREE, 1966)	Eel (ARAI and co-authors, unpublished)
Thiamine	●; muscle atrophy; convulsions prior to death; loss of equilibrium	□; fading of body colour; congestion of fins and skin	□; lethargy; loss of equilibrium	●; □; ■; haemorrhage in fins; dark colouration
Riboflavin	●; cloudy lens; haemorrhagic eyes; in-coordination; dark colouration	●; □; ×; haemorrhages in both epidermis and hepatopancreas	×; opaque lens of one or both eyes	●; □; haemorrhage in fins; dermatitis; photophobia; sluggish movement
Pyridoxine	●; ■; anaemia; nervous disorders; epileptiform fits; oedema; flexing of opercles	●; ■; nervous disorders; epileptiform fits; oedema; exophthalmos	□; ×; erratic swimming; tetany; gyrations and muscular spasms when stressed	●; □; nervous disorders; epileptiform fits; convulsions
Pantothenic acid	●; clubbed gills; gills covered with exudate; sluggishness	●; □; nervousness; haemorrhage of body surface	□; ×; lethargy; ○ flabby body tissues; ○ mummy-textured skin; clubbed gills	●; □; ■; ×; haemorrhage in epidermis; skin lesions; dermatitis
Inositol	□; distended stomach; increased gastric emptying time	●; □; skin lesions	None	●; □; white-grey coloured intestine
Biotin	●; lesions in colon; muscle atrophy; spastic convulsions; fragmentation of erythrocytes	□; histological changes in tissues including blood corpuscles	None	●; □; ■
Folic acid	□; anaemia; lethargy; fragility of caudal fin; dark colouration	None	●; ×; lethargy	●; □; dark colouration
Choline	●; poor feed conversion; haemorrhagic kidney and intestine	□; accumulation of neutral fat in hepatopancreas	□; haemorrhagic kidney and enlarged liver	●; □; ■; white-grey coloured intestine
Nicotinic acid	●; ■; lesions in colon; oedema of stomach and colon; muscle spasms	●; □; ×; haemorrhage in skin	Tetany and eventual death in stress; lethargy; reduced coordination	●; □; ■; anaemia; haemorrhage in epidermis; skin lesions
Vitamin B ₁₂	●; haematological disorders	None	□	●; □
<i>p</i> -Amino-benzoic acid	None	None	None	None
Ascorbic acid	Scoliosis; lordosis; impaired collagen formation; eye lesions; haemorrhagic tissues	Not studied	None	●; □; haemorrhage in fins, head and skin; lesion in lower jaw

Key: ● = poor appetite; □ = poor growth; ■ = ataxia; × = mortality; ○ unpublished data.

Food ration and feeding schedule

The food ration, i.e. the daily allowance for one fish, and the feeding schedule, i.e. the time plan for offering food (either for a given period of time, e.g. per day, or for successive developmental stages), are of considerable importance for survival, development and reproduction.

In ecological studies, food ration and feeding schedule should be related to the natural activities of the fish studied. They must account for diurnal (day-active versus night-active forms), seasonal or annual variations; for age, developmental stage and body size; as well as for temperature, salinity and other environmental factors (Volume I). In farming projects, food ration and feeding schedule must be adjusted so as to obtain a maximum fish harvest on a minimum of food.

In high-density cultures of catfish *Ictalurus punctatus*, the frequency of feeding per day has been shown to affect growth (ANDREWS and PAGE, 1975). Maximum rate and efficiency of growth were obtained in fish fed to satiation 2 times day⁻¹. While growth was reduced in groups fed only once day⁻¹, feeding 4, 8 or 24 times day⁻¹ did not significantly improve growth. Since growth efficiencies were similar

Table 5-109

Vitamin requirements (mg kg⁻¹ dry weight) established for growth of the fishes listed. Fish fed at reference temperature with diets at protein requirement. R: required (After HALVER, 1972b; reproduced by permission of Academic Press Inc., New York)

Vitamin	Rainbow trout	Brook trout	Brown trout	Chinook salmon	Coho salmon	Carp	Eel	Goldfish	Yellowtail	Channel cat fish
Thiamine	10-12	10-12	10-12	10-15	10-15	R	R	R	R	R
Riboflavin	20-30	20-30	20-30	20-25	20-25	7-10				R
Pyridoxine	10-15	10-15	10-15	15-20	15-20	5-10			R	R
Pantothenate	40-50	40-50	40-50	40-50	40-50	30-40		R	R	R
Niacin	120-150	120-150	120-150	150-200	150-200	30-50				R
Folacin	6-10	6-10	6-10	6-10	6-10	?				R
Cyanocobalamin	R	R	R	0.015-0.02	0.015-0.02	?				R
<i>myo</i> -Inositol	200-300	R	R	300-400	300-400	200-300				R
Choline	R	R	R	600-800	600-800	1500-2000				R
Biotin	1-1.2	1-1.2	1.5-2	1-1.5	1-1.5	1-1.2	R		R	R
Ascorbate	100-150	R	R	100-150	50-80	R		R	R	R
Vitamin A	2000-2500	R	R	R	R	1000-2000		R	R	R
Vitamin E*	R	R	R	40-50	R	80-100			R	R
Vitamin K	R	R	R	R	R					R

* Requirement directly affected by amount and type of unsaturated fat fed.

in fish fed 1, 2 or 4 times day⁻¹, ANDREWS and PAGE conclude that food intake rather than food utilization limits growth.

In cultivated young sockeye salmon *Oncorhynchus nerka*, a restricted food ration (as long as fully consumed) results in a quasi-fixed growth rate until size becomes a limiting factor reducing food demand below the prescribed level and thereby reducing growth rate (BRETT and SHELBOURNE, 1975). An excess ration causes the specific growth rate to fall from 3.6% weight day⁻¹ (2.4 g mean weight) to 1.0% weight day⁻¹ (37 g mean weight).

Food ration and feeding schedule affect the efficiency of food conversion into body-own substances and biologically useful energy (Volume II: PANDIAN, 1975), as well as culture-water quality (this volume, Chapter 2). Examples of feeding schedules, worked out for subsequent developmental stages of young puffers *Fugu rubripes* and *F. vermicularis*, as well as for black porgy *Mylio macrocephalus*, are presented in Table 5-110.

Table 5-110

Feeding schedules for young puffers *Fugu rubripes*, *F. vermicularis* and black porgy *Mylio macrocephalus* (Data presented in BARDACH and co-authors, 1972)

Puffers

Time after hatching (days)	Body length (mm)	Population density (fish l ⁻¹)	Food
0-6	2.6-2.8	10-100	None
7-10	3.5-4.0	10-100	Nauplii of barnacles
11-14	—	10-100	Nauplii of barnacles and <i>Artemia salina</i>
15-20	—	10-100	Nauplii of <i>A. salina</i>
21-25	—	5-10	Nauplii of <i>A. salina</i> ; <i>Tigriopus japonicus</i> ; minced fish flesh
26-30	—	0.5	Nauplii of <i>A. salina</i> ; <i>Tigriopus japonicus</i> ; minced fish flesh
31-44	—	0.5	Minced fish flesh
45-50	25 or more (seedling size)	0.5	Minced fish flesh

Black porgy

Time after hatching (days)	Food	No. of daily feedings
0-1	None	—
2-7	Trochophore larvae of oysters	1
8-14	Trochophore larvae of oysters; gradual change to barnacle nauplii	1 of oyster larvae, 3-4 of barnacles
15-17	Barnacle nauplii	3-4
18-32	Barnacle nauplii and marine copepods (freshwater copepods may be substituted); gradual change to 100% copepods	3-4 of barnacles and 1 of copepods (freshwater copepods must be added more often, as they do not survive in sea water)
33-34	Copepods	1
35-40 (seedling stage)	Minced fish meat and/or pelleted commercial fish feed	Empirically determined

Gamete Maturation and Release

Together with the rearing of larvae as well as of juveniles and adults, controlled gamete maturation and gamete release hold the key to life-cycle studies, offspring

production and genetic experimentation (including stock improvement). In captive fishes, gamete maturation and release has been obtained by (i) providing environmental and nutritional conditions conducive to the natural ripening of sexual products and their release (natural breeding); (ii) induction of gamete maturation and release by artificial means, e.g. by hormone injection (artificially induced breeding). For maximum responses, conditions conducive to natural breeding and hormone injection can be combined.

The first attempt to breed a fish with seasonal reproductive habits in captivity should be scheduled to parallel its natural breeding season. Once the factors essential to success have been determined, it may be possible to condition the fish to reproduce outside its normal breeding season—ideally, at any time desired by the experimenter. Conditioning procedures should include appropriate changes in all essential factors, e.g. light (day length), temperature and nutrition.

The fact that some marine fishes mature sexually in captivity, but fail to spawn, indicates the absence of certain key stimuli which induce oviposition and sperm release under natural conditions. Presumably, natural stimuli are, to a large extent, species specific and, in their efficacy, depend upon the degree of gonad maturation. Natural stimuli may include: aspects of behaviour; sexual products of conspecifics; presence or absence of other organisms or of objects (e.g. material for nest building or a suitable substratum for egg attachment); changes in water quality or water depth.

Natural breeding

Natural gamete maturation and release in captive marine fishes has remained a rare phenomenon. Among the environmental factors which affect breeding in fishes, light (Volume I: BLAXTER, 1970a, pp. 238, 253; see also SEGAL, 1970, p. 190), temperature (Volume I: BRETT, 1970, p. 552; see also KINNE, 1970, p. 488) and nutrition play a dominant role. In spite of numerous papers devoted to the study of light and temperature effects on breeding in fishes (e.g. SUNDARARAJ and VASAL, 1973, 1976), definite results are scarce and the pertinent body of knowledge has remained fragmentary—more so than in birds or mammals. Breeding habits and sexual maturation of captive fishes have been reviewed by KAUSCH (1973).

A detailed compilation of the information available on breeding season, breeding site, migration, secondary sex characters, sex discrimination, competition for mates, courtship, mating and parental care in fishes has been presented by BREDER and ROSEN (1966).

Light acts, to a considerable degree, through variations in day length (photo-period). Under natural light conditions, changes in wave length seem to be of lesser importance. While appropriate light conditions have been shown to be effective even at very low levels (light 'intensities'), reports on upper limiting natural irradiances have not come to the reviewer's attention. In the stickleback *Gasterosteus aculeatus*, the lower sensitivity level is approximately 1 lux (MCINERNEY and EVANS, 1970).

While in tropical regions with permanent 12-hr photoperiods and without marked seasonal changes in temperature, many species may reproduce all year round, in temperate regions, increasing or decreasing day lengths tend to induce gamete

maturation, and often also stimulate gamete release. In *Oncorhynchus nerka*, for example, day lengths of 16 or 24 hrs delay, while day lengths of 0 or 8 hrs accelerate gamete maturation (COMBS and co-authors, 1959; SHIRAISHI and FUKUDA, 1966). Similarly, in *Mugil cephalus*, at 21° C, a short day of 6 hrs light induces the completion of vitellogenesis of oocytes and functional maturity (KUO and co-authors, 1974b); gonad maturation in *Engraulis mordax* proceeded after exposure to a photoperiod of 4 hrs light at 15° C (LEONG, 1971). Surprisingly, light may sometimes produce different responses in males and females. Thus in male brook trout *Salvelinus fontinalis*, sexual maturation was accelerated by exposure to continuous light and retarded by continuous darkness, while both conditions led to retardation in females (POSTON and LIVINGSTON, 1969).

Detailed analyses of the effect of different wave lengths remain to be conducted. In the ayu *Plecoglossus altivelis*, short wave lengths (blue and green light) seem to accelerate gonad maturation, while long wave lengths (red and yellow) retard it (SHIRAISHI, 1965a). However, stickleback *Gasterosteus aculeatus* exposed to four wave-length ranges (388–466, 455–518, 513–583, 585–653 nm) and compared with two controls (experimental and wild) revealed no major differences in gamete maturation (MCINERNEY and EVANS, 1970).

No definite information is available on the physiological mechanism through which light affects maturation and reproduction of fishes. Experiments on *Plecoglossus altivelis* have ruled out the eye as primary perceptor (SHIRAISHI, 1965b). The possibility of direct effects on germ cells or skin or on hormone production remains to be investigated; the same holds for possible indirect effects, e.g. through variations in activity.

Adequate temperature conditions are a prerequisite for allowing light to affect gamete maturation and release. No fish will breed at critically low or high temperatures. Within the thermal norm, slowly increasing (or decreasing) temperatures have been shown to initiate and to support gamete maturation (Volume I). Temperature may also act as releaser of courting behaviour and of spawning migrations (Volume II: TESCH, 1975).

Captive sole *Solea solea* failed to breed, apparently because of malnutrition (FLÜCHTER and TROMMSDORFF, 1974). The cooked mussels *Mytilus edulis* normally used as food source, turned out to be deficient in a number of amino acids which seem to be essential for final egg maturation. Such nutritional deficiency could be compensated for by dietary casein which induced intensive spawning.

The potential role of other environmental factors, e.g. salinity, substratum, pressure, organic substances (Volume I), as well as tides, remains to be analyzed. In estuarine, coastal and anadromous species, salinity may attain prime importance (Volume I: HOLLIDAY, p. 1025). However, in most cases the factors mentioned above appear to be less effective than light and temperature.

Natural breeding of a captive marine fish is exemplified here by referring to the northern anchovy *Engraulis mordax*. LASKER (1974) kept about 1000 *E. mordax* (>110 mm standard length) in plastic swimming pools (4.6 m diameter, 0.7 m water depth). Each pool received sand-filtered, ultra-violet-irradiated, natural sea water (15° C) at the rate of 38 l min⁻¹. Light from a 200-W incandescent lamp provided 32 f.c. at water surface (photoperiod: 4 hrs light, from 8 a.m. to 12 noon). During the 'dark' period, two 3-W lamps gave 1 to 2 f.c. at water surface in order to prevent the

anchovies from colliding with the tank wall. Oregon moist chow, 0.6 kg day⁻¹, provided with an automatic feeder after hand feeding of 0.34 kg of frozen *Artemia salina*, served as food source. Under these conditions, all *E. mordax* achieved an average gonad index of 5. Never have all eggs been found to be unfertilized, and occasionally, up to 100% fertilization was recorded. Hatching success varied from less than 1% to over 80% (average: 20%). Spawning occurred chiefly between 8 p.m. and midnight. Similar information has been provided by LASKER for *Scomber japonicus*, *Bairdiella icistia* and *Morone saxatilis*.

A detailed review of the pertinent literature is, at present, not considered very useful. We summarize the information at hand as follows: (i) Natural breeding may be induced by appropriate changes in light and temperature regimes, supported by a suitable diet. While the importance of light or temperature may differ with the species involved, maximum responses are usually obtained by light and temperature stimuli acting in concert. (ii) The timing of light and temperature stimulation must be considered against the background of the fish's environmental history and its present physiological state. The stimulation can be enforced by concurrent changes in other environmental circumstances and in nutrition, as well as by hormone injections (see below). (iii) Maximum efficiency of breeding activities outside the natural spawning period usually requires, in addition to a proper combination of stimuli, a preceding rest period. (iv) Spawning may require specific stimuli and can often be encouraged after temporary separation of male and female breeders. (v) Spawning activities are often a function of day time; many species spawn most readily at dawn or dusk.

Artificially induced breeding

On the long road of fish cultivation, hormone-induced gamete maturation and gamete release constitute an important mile stone. Pioneered in Brazil in 1935, hypophysation techniques are now widely used and have helped to breed fishes that had previously refused to reproduce under culture conditions; for details consult the reviews by ATZ and PICKFORD (1959), DODD (1960), IBRAHIM (1969a, b), JHINGRAN (1969) and SHEHADEH (1972). The preparation, preservation and storage of hormone materials, as well as a list of hormone-treated fishes have been reviewed by SHEHADEH (1973). The general role of hormones and of compounds presumably intervening via hormonal mechanisms in the reproduction of teleosts has been considered by FONTAINE (1976) and YAMAZAKI (1976).

Numerous studies on hormone-induced breeding in fishes document that both pituitary and chorionic gonadotropins can induce gamete maturation, ovulation and often also spawning. The hormones used come either from fishes or mammals. In the grey mullet *Mugil cephalus*, for example, gamete maturation has been obtained (i) by injecting homogenates of mullet pituitary glands (TANG, 1964; LIAO and co-authors, 1972); (ii) pituitary homogenate of carp (YASHOUV, 1969) and Pacific salmon (SHEHADEH and ELLIS, 1970; MESTER and co-authors, 1974); (iii) purified salmon gonadotropin (SHEHADEH and co-authors, 1973a; NASH and co-authors, 1974); (iv) mammalian hormones such as human chorionic gonadotropin (KUO and co-authors, 1973, 1974a; MESTER and co-authors, 1974) and synahorin (LIAO and co-authors, 1972). MAY and co-authors (1974) injected mature *Siganus canaliculatus* (syn.: *S. oramin*) with Antuitrin-S, and VON WESTERNHAGEN

and ROSENTHAL (1975) obtained gamete maturation in the same species after injecting human chorionic gonadotropin (0.25 to 0.3 I.U. g^{-1} body weight).

Procedural details of artificially induced breeding in a marine fish may be exemplified by referring to the grey mullet *Mugil cephalus*. KUO and co-authors (1974a) suggest the following treatment: (i) Determine the stage of maturity of intraovarian oocytes by removing these *in vivo* from an unanaesthetized female through a polyethylene cannula (SHEHADEH and co-authors, 1973b). Insert the cannula into the oviduct and suck oocytes into the tube as the cannula is withdrawn. The distance to which the cannula is inserted depends on the length of the ovary.

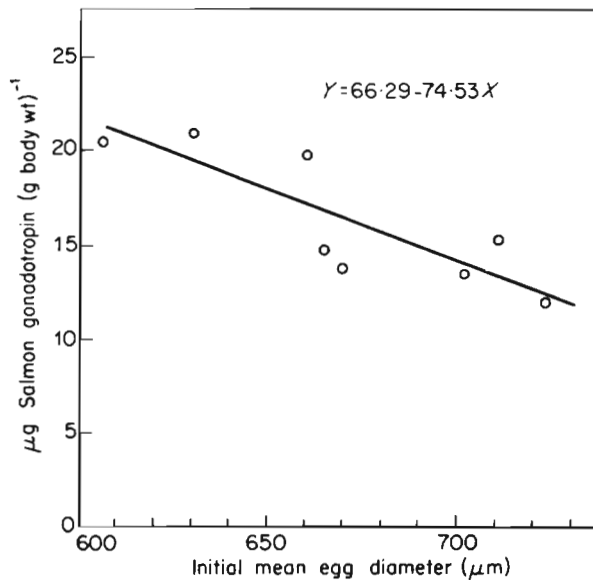

Fig. 5-111: *Mugil cephalus*. Relationship between initial mean egg diameter of recipient females and the amount of salmon gonadotropin required to induce spawning. (After SHEHADEH and co-authors, 1973a; reproduced by permission of Academic Press, London.)

Oocytes from the mid-ovary region are most representative. Remove oocytes from cannula, wash and preserve them in a mixture of 1% formalin plus 0.6% NaCl, and measure their diameter along the horizontal axis. (ii) When the oocytes are filled with yolk and have a mean diameter of at least 600 μm —preferably one in excess of 650 μm —initiate hypophysation of gravid females. (iii) Use purified salmon gonadotropin described by DONALDSON and co-authors (1972) 1 mg being equivalent to 2150 I.U. of human chorionic gonadotropin. The hormone quantity required is inversely proportional to the initial mean egg diameter (Fig. 5-111); it varies between 12 and 21 μg (g body weight) $^{-1}$ (SHEHADEH and co-authors, 1973a). (iv) Apply hormone in two injections: for first injection, use $\frac{1}{3}$ of total dose; for second injection (48 hrs later), the remaining $\frac{2}{3}$. This sequence appears to be critical to avoid partial spawning. First observed 8 hrs after the second injection,

Table 5-111

Mugil cephalus. Responses of mature individuals to hormone treatment: ovulation, fertilization and hatching (After LIAO, unpublished; reproduced by permission of the author)

Standard length (cm)	Injection				Ovulation		Ovulating time after receiving the initial injection	Total number of eggs
	1st injection		2nd injection		Date	%		
	Date	Dosage	Date	Dosage				
?	5-I-69	1-3P	6-I-69		7-I-69		46 hrs 30 mins	?
	11:30	10RU	9:30	2P + 20RU	10:00	100		
?	19-XII-69	2P + 10RU	20-XII-69		22-XII-69		67 hrs 15 mins	?
	16:00	150VE	16:10	2P + 20RU	11:15	?		
?	20-XII-69	2P + 10RU	21-XII-69		21-XII-69		30 hrs 40 mins	?
	16:20	150VE	14:20	1-5P + 20RU	23:15	90		
?	28-XII-69	1P + 20RU	29-XII-69		30-XII-69		46 hrs 15 mins	—
	16:15	150VE	14:45	2P + 20RU	14:30	90		
38-0	20-XII-70	2P + 10RU	21-XII-70		22-XII-70		46 hrs 14 mins	1,002,000
	15:08	150VE	13:22	2P + 20RU	12:55	90		
41-0	20-XII-70	2P + 10RU	21-XII-70		22-XII-70		48 hrs 6 mins	1,068,000
	15:12	150VE	13:27	2P + 20RU	15:18	80		
45-2	25-XII-71	3P + 20RU	26-XII-71	3P + 20RU	26-XII-71	10	33 hrs 13 mins	1,888,110
	11:57	200VE	12:12	+	21:10 23:05	80		
46-8	6-I-73	2P + 20RU	7-I-73	2P + 30RU	8-I-73		30 hrs 7 mins	1,571,000
	18:33	100VE	18:24	+	0:45 1:40	100		
				150VE			32 hrs 2 mins	

P: Pituitary of mullet (in number of glands)

RU: Synahorin (in Rabbit Units)

VE: Vitamin E (in mg)

Table 5-111—Continued

Number of fertilized eggs	Fertilization Rate %	Hatching Date	Hatching Rate %	Hatching time after fertilization	Remarks
30 × 10 ⁴	100	9-I-69 6:00 10-I-69 3~4:00	80	44 hrs (23~24° C) 65 hrs (21° C)	Natural spawning at 10:00, Jan. 7, was followed immediately by artificial fertilization.
8 × 10 ⁴	64	24-XII-69 17:00	100	53 hrs 45 mins (22.7~23.7° C, 30.08~33.99‰)	No response occurred following the first two injections. However, a response was noted in the evening to third injection of 1P + 20RU at 14:25, Dec. 21.
?	90	23-XII-69 15:25	100	40 hrs 10 mins (24.0~24.7° C, 32.49~33.29‰)	Belly became swollen after the first injection. Natural spawning at 23:00, Dec. 21; the remaining eggs were artificially fertilized at 23:15 and hatched in hanging net.
—	63	1-I-70 5:00	100	38 hrs 30 mins (24.0~24.5° C, 32.5~33.22‰)	Spawning progression was favourable. Release of 'water eggs' induced by gentle pressure on belly.
633,600	63.2	24-XII-70 2:30	90	37 hrs 35 mins	Belly became swollen in the morning on Dec. 22 and 'water eggs' were released.
660,000	61.7	24-XII-70 2:30	90	35 hrs 12 mins	Belly became swollen in the morning on Dec. 22.
1,188,000	62.9	25-XII-71 19:50	90	46 hrs 40 mins	Belly became swollen at 9:30 on Dec. 26. Another injection of 50RU of Synahorin was administered at 20:10 on Dec. 26.
1,041,500	66.3	9-I-73 23:00	55.7	46 hrs 15 mins	Weight of pituitary glands (preserved in acetone and used for injection) was 0.0086 g + 0.0095 g for 1st injection and 0.0170 g + 0.0058 g for 2nd injection. At 15:00 on Jan. 7, the belly was distinctly swollen.

abdominal distension and protrusion of the cloacal region increase as a result of hydration. (v) About 10 hrs after the second injection, add 2 or 3 males to the female (200-l aquarium). As hydration progresses, indicated by belly distension and frequent excretion of calcium deposits, the males' activity increases. At the time of spawning, the water content of the eggs increases to 83.5%. (vi) The first release of a small number of ripe eggs stimulates the males to liberate spermatozoa. Within their natural spawning season, captive males do not require hormone injection for

spermiogenesis. In the pre-spawning season, spermiation can be induced by injections of 17α -methyltestosterone: 5 mg (100 g body weight)⁻¹ (SHEHADEH and co-authors, 1973c).

Results of hormone injections administered to mature *Mugil cephalus* by LIAO (unpublished; see also LIAO and co-authors, 1972) are listed in Tables 5-111 and 5-112. LIAO used the following substances: (i) Pituitary glands obtained from male or female *M. cephalus*, caught during the same annual migration. The amount of gland homogenate (usually stored at 5° C in acetone) was expressed in numbers of glands used. (ii) Synahorin, a mixture of chorionic gonadotropin and mammalian hypophyseal extract, was expressed in numbers of Rabbit Units (RU). (iii) Other gonadotropins such as Gonagenforte (expressed in Rat Units) and Puberogen (expressed in International Units). (iv) Vitamin E injections consisting of Acetate

Table 5-112

Mugil cephalus. Efficacy of hormone treatment (After LIAO, unpublished; reproduced by permission of the author)

Year	Total number treated	No ovulation	Ovulation but no hatching	Hatching	Wrong sex identification	Numbers of fingerlings reared
1968/1969	30	9 29.8%	16 53.0%	3 10.0%	2 6.6%	2
1969/1970	19	5 26.3%	3 15.8%	9 47.4%	2 1.5%	431
1970/1971	28	8 28.6%	8 28.6%	11 39.3%	1 3.6%	7786
1971/1972	30	12 40.0%	7 23.4%	10 33.3%	1 3.3%	23,695
1972/1973	42	11 26.2%	11 26.2%	19 45.2%	1 2.4%	21,688

dl-alpha-tocopherol (expressed in mg). Best results were obtained by administering the second injection within 24 hrs after the first one. Third or fourth injections were given if the preceding injections failed to produce appreciable responses. Females requiring more than 4 injections are usually poor spawners.

Even in eels *Anguilla anguilla* have hormone injections paved the way to artificially induced breeding. In males, hormone-induced maturation has been obtained by FONTAINE (1936), TUZET and FONTAINE (1937), ETIENNE (1959), OLIVEREAU and HERLANT (1960), OLIVEREAU (1961), MESKE and CELLARIUS (1972) and others. MESKE and CELLARIUS (1973) and MESKE (1973a, b) report successful raising of male eels from elvers to sexual maturity (22° to 23° C; initial rearing in fresh water, then gradual change to sea water, or rearing in fresh water only); intramuscular injections with 0.2 ml protein-free calf-spleen extract (Solcosplen) plus 50 RU mammalian gonadotropic hormone (Synahorin) facilitated spermatozoa maturation. Free spermatozoa are highly motile, sickle-shaped and measure about 9 μ m without the flagellum; the latter extends over a length of about 30 μ m.

Female eels have been induced to mature up to oviposition by FONTAINE and co-authors (1964) and NOSE (1971); see also CAMBELL (1969) and ANONYMOUS (1971a). After application of Organon, Prolan and Oestradiol had failed (FONTAINE, 1961), FONTAINE and co-authors obtained success by administering carp-pituitary extract and, 3 months later, desoxycorticosteronacetate. NOSE obtained egg release in *Anguilla japonica* after intramuscular injections of Synahorin, diethylstilboestrol, homogenized rainbow trout pituitary and alpha-tocopherol. A treated female spawned at night and released eggs of 1.06 mm mean diameter. OCHIAI and co-authors (1972, 1974) obtained ready-to-spawn *A. japonica* females after 4 months treatment with follicle hormone (dipropionic acid estradiol) and Synahorin. Apparently, pituitary extract of fishes is most efficient in inducing gamete maturation of female eels (YAMAMOTO and co-authors, 1974; EDEL, 1975a; VILLANI and LUMARE, 1975).

YAMAMOTO and YAMAUCHI (1974) were the first investigators who succeeded in obtaining mature male and female *Anguilla japonica* simultaneously. For fertilization, they used 20 mature, Synahorin-treated males and 5 mature, salmon-pituitary-treated females (YAMAMOTO and co-authors, 1974). Fertilization was obtained in sea water at 23° C. The larvae hatched 38 to 45 hrs after fertilization. Four larvae survived for 5 days and attained at that time total lengths of 4.8, 5.3, 5.9 and 6.2 mm, respectively. On the third day, mouth and anus were open and the pectoralia appeared.

Peptide hormone LH-RH has induced ovulation in the ayu *Plecoglossus altivelis* (HIROSE and ISHIDA, 1974). Within 2 days after a single injection, ovulation was clearly observable in fish which had received 200 µg LH-RH. In LH-RH treated fish, body weight increased rapidly by several percent. Water and Na content were also greater than in the controls. By causing the release of endogenous gonadotropin, LH-RH induces the same sequence of ovarian events as does exogenous gonadotropin.

Most of the reports on hormone-induced gamete maturation and release available cannot be used for comparative evaluations because of methodological inconsistencies. Major difficulties are due to the fact that dose efficacy depends on the degree of sexual maturity of both recipient and donor, their phylogenetic relationship, the hormone content in the injected preparation, and the physiological state of the fish treated (PICKFORD and ATZ, 1957). Future investigations should be directed towards (i) the search for objective, handy criteria for defining and determining the state of maturity of the fish to be treated; (ii) definition and standardization of dosage and of injection procedure (intramuscular or intraperitoneal); (iii) a better understanding of the mechanism of ovulation and of the significance of water and salt regulation for egg maturation and ovulation; (iv) preparation of purified hormone solutions; (v) analysis of the relationship between hormone treatment, rates of fertilization, hatching and survival of larvae.

As in other organisms, e.g. gastropods (p. 898) and bivalves (p. 925), gamete release in ripe fishes can be initiated by a variety of artificial stimuli such as rough handling, sudden changes in environmental conditions, or by chemical or electrical shocks. Gamete release due to artificial stimuli apparently correlated with capture procedures may be exemplified by the spawning of about 300 newly caught, ripe (15 cm standard length) Pacific herring *Clupea harengus pallasii*, both in a circular

tank (1.8 m diameter, 0.7 m water depth) and in an oval tank (7 × 2.4 m, 1 m water depth). HOURSTON and co-authors (1975) kept the herring under the following conditions: open sea-water system; continuous light from a 40-W lamp (during the day, augmented by dim natural light); 9° to 10° C; 27‰ to 31‰S; food: frozen plankton, later fish pellets. The herring began to spawn a few hours after transfer to culture conditions. According to HOURSTON and co-authors, the females preferred standpipe and glass wall as egg deposition sites, even though plants of the types frequented during *in situ* spawnings were provided. Interestingly, in another experiment, the herring spawned spontaneously after spending 2 months in captivity (ROSENTHAL, personal communication).

Storage of spermatozoa

Storage of spermatozoa—widely used for artificial insemination, genetic analyses and selective breeding in warm-blooded domesticated animals—requires further research in fishes. BLAXTER (1953, 1955) stored spermatozoa of freshly caught *Clupea harengus* at -79° C for periods of up to 6 months with negligible loss of fertility. He placed sections of ripe testes in a mixture of 80% sea water and 12.5% glycerol (protector), froze the mixture slowly (1 C° min⁻¹) or quickly to -30° C, and then by adding dry ice, quickly to -79° C. Six-month-old sperm thawed at 40° C, fertilized fresh eggs with efficiencies of 80% and 85% for slowly and quickly frozen sperm, respectively. TRUSCOTT and co-authors (1968) and TRUSCOTT and IDLER (1969) obtained fertilization with cold-stored sperm of *Salmo salar*, and MOUNIB and co-authors (1968), of *Gadus morhua*.

These and further examples are documented in Table 5-113. The data at hand are insufficient for qualified generalizations. No satisfactory method has yet been found for long-term storage of fish eggs.

In their review on cryopreservation of fish spermatozoa, HORTON and OTT (1976) summarize the present status of fish-gamete storage. They consider collecting, freezing, thawing and testing of spermatozoa, and point out that the best methods entail manual stripping for semen, rapid freezing in the vapour of liquid nitrogen, and rapid thawing of spermatozoa—combined with fertilization tests employing fresh eggs. An assessment of common constituents of sperm-life extenders indicates that a simple extender consisting of two salts—sodium chloride, ca 800 mg (100 ml)⁻¹, and sodium bicarbonate, ca 800 mg (100 ml)⁻¹—plus lethitin, ca 750 mg (100 ml)⁻¹, seems as adequate as more complex extenders comprising one or two dozen components. Dimethyl sulphoxide provided best protection of salmonid spermatozoa from freezing damage. A selected bibliography on collection, fertilization, vitality, storage and cryopreservation of gametes, particularly those of salmonids, has been presented by WILTZIUS (1973).

Genetic Recombination and Stock Improvement

Genetic recombination is of basic importance for genetic analyses of natural populations (Volume II: GOOCH, 1975) and for improving the characteristics useful to man of fish stocks used in commercial cultivation (stock improvement). Thus far, domestication of fishes involving controlled breeding is largely restricted to freshwater forms such as carp, goldfish, trout and 'pet fishes' (e.g. DZWILLO,

Table 5-113
 Examples of cold-stored fish spermatozoa used for fertilizing ripe, fresh eggs (Compiled by SHEHADEH, 1973, from the sources indicated)

Species	Component	Conc.	Protector	Storage temp. (°C)	Storage time	Fertilization† (%)	Author
<i>Glupea harengus</i>	80% sea water		glycerol	-79.0	6 months	80-85	BLAXTER (1953)
<i>Cyprinus carpio</i>	Frog Ringer solution		glycerol 6-12%	-73.0	60 hrs	20% motility	SNEED and CLEMENS (1959)
<i>Gadus morhua</i>	NaCl Glycine With addition of mannitol	0.4 M 0.1 M	glycerol	-79.0	1 year	18	MOUNIB and co-authors (1968)
<i>Oncorhynchus tshawytscha</i> and <i>O. kisutch</i>	Na ₃ citrate dextrose	0.80% 2.05%	DMSO	-196.0	7 days	38-79	OTT and HORTON (1971a)
<i>Oncorhynchus tshawytscha</i> and <i>O. gorbuscha</i>	NaCl [Procedure according to Mounib and co-authors (1968)]	0.40%	25%	-196.0	7 days	(motile sperm recovered)	HODGINS and RIDGEWAY (1964)
<i>Pleuronectes platessa</i>	NaCl				315 days	39	PULLIN (1972)
<i>Salmo gairdneri</i>	NaCl KCl CaCl ₂ .2H ₂ O NaHCO ₃ Na ₂ H ₂ PO ₄ MgSO ₄ .7H ₂ O Fructose Lecithin With addition of mannitol	0.12500 g l ⁻¹ 0.00509 0.00157 0.00119 0.00297 0.00933 0.00555 5.00000	DMSO 15-12.5%	-196.0	14-28 days	18	GRAYBILL and HORTON (1969)
<i>Salmo salar</i>	NaCl CaCl ₂ .2H ₂ O KCl NaH ₂ PO ₄ .H ₂ O NaHCO ₃ MgSO ₄ .7H ₂ O Glucose (Modified Cortland medium)	1.88 g l ⁻¹ 0.23 7.20 0.41 1.00 0.23 1.00	DMSO, † 5% EG, § 5% EG, 5%	-196.0 -4.5 -3.0 -25.0	7 days 28 days 38 days 30 min	59 81 70 12	OTT and HORTON (1971b) TRUSCOTT and co-authors (1968) TRUSCOTT and co-authors (1968) HOYLE and IDLER (1968)
<i>Salmo salar</i>	NaCl KCl CaCl ₂ MgSO ₄ .7H ₂ O Fructose Glycine pH	6.04 g l ⁻¹ 1.64 0.143 0.223 0.60 6.00 6.4	PG, ¶ 7-12% DMSO, 10%	-169.0	10-21 days	5-19	TRUSCOTT and IDLER (1969)

* Consult author's paper for freezing rates and equilibration time. § Ethylene glycol.
 † Percentage of fresh eggs fertilized, unless otherwise indicated. ¶ Propylene glycol.
 ‡ Dimethyl sulphoxide.

1962). In some commercially used marine fishes, genetic recombination and stock improvement are about to enter the experimental phase. Genetic recombination is facilitated by the fact that mature fish can be stripped (p. 1021) and that their spermatozoa may be stored over appreciable periods of time (p. 1029; see also Chapter 5.2, p. 1374).

Numerous fish hybrids have been produced with the aim of improving characteristics useful for commercial cultivation. Among marine fishes, hybridization between different flat fish species is well known in the field and has been produced artificially under laboratory conditions. Within the family Pleuronectidae, naturally occurring intergeneric hybrids between plaice *Pleuronectes platessa* and flounder *Platichthys flesus* are known, for example, from the Baltic Sea and can be produced easily by artificial fertilization. Plaice eggs have been fertilized with flounder spermatozoa by PAPE (1935) and VON UBISCH (1953). Other artificial pleuronectid hybrids include dab *Limanda limanda* × flounder *Platichthys flesus* (RILEY and THACKER, 1969), plaice *Pleuronectes platessa* × lemon sole *Microstomus kitt*, and *P. flesus* × *M. kitt* (THACKER, personal communication to PURDOM and LINCOLN, 1974).

According to PURDOM and LINCOLN (1974), a combination between halibut *Hippoglossus hippoglossus* and plaice *Pleuronectes platessa* seems very promising: *H. hippoglossus* grows rapidly even at low temperatures and has flesh of high quality; *P. platessa* eggs and larvae, in contrast to those of halibut, can be hatched and reared easily. Unfortunately, thus far, attempts to produce hybrids between *P. platessa* or *Platichthys flesus* (eggs) and *H. hippoglossus* (spermatozoa) have failed. The resulting offspring were shown to be haploids arising by gynogenesis. Cold shocks applied within 20 mins after fertilization led to diploid embryos and larvae of maternal appearance. Irradiation of halibut spermatozoa (^{60}Co γ rays at 100,000 rad) affected neither fertilization nor subsequent embryonic development. Cold treatments failed to produce normal diploid offspring. Although true hybrids have not yet been produced between plaice and halibut, PURDOM and LINCOLN stress that the gynogenetic offspring can be useful in the production of inbred lines and in genetic analyses (see also p. 1374).

Gynogenesis—egg development due to spermatozoa penetration, but without syngamy—provides unisexual populations. It may be useful in selective breeding, as well as in genetic studies (location of recessive genes; experiments on chromosome crossovers and chromosome linkages). Natural gynogenesis occurs only in very few species. In cultivation and experimental biology, gynogenesis has been achieved in various ways, e.g. by pricking an unfertilized egg with a needle dipped in serum or blood; by using spermatozoa from heterospecifics (e.g. spermatozoa of *Abramis brama* penetrating eggs of *Cyprinus carpio*; spermatozoa of *Salmo trutta* penetrating eggs of *Salvelinus fontinalis*); by using spermatozoa containing DNA denatured by high irradiation doses; by employing thermal shocks. Not all these techniques are equally successful. For details consult KALLMAN (1962), ROMASHOV and co-authors (1963), BEATTY (1964), ROMASHOV and BELYAEVA (1965), VASSILEVA-DRYANOVSKA and BELCHEVA (1965), GOLOVINSKAYA (1969), PURDOM (1969), TSOY (1972), PURDOM and LINCOLN (1974) and STANLEY and SNEED (1974).

Mono-sex culture of *Tilapia* species is considered the best solution to overpopulation caused by very high fecundity under pond conditions (HICKLING, 1963).

Since males of *Tilapia* species grow much faster than females (e.g. HICKLING, 1967; PRUGININ, 1967a, b; SHELL, 1967; KIRK, 1972), the most elegant solution to overpopulation and to sex-sorting difficulties in fingerlings is the rearing of all-male broods. These have been obtained by crossing *T. nilotica* females and *T. aurea* males (PRUGININ and co-authors, 1975). Two *T. nilotica* mothers of all-male hybrid broods were paired with unselected *T. nilotica* males; all their daughters produced all-male hybrid broods when crossed with *T. aurea* males.

(d) Pisces as Assay and Food Organisms

As in other organisms, pollutant effects which are lethal within the individual's life span deserve not more than peripheral interest from ecologists. They are so obvious and, under field conditions, cause such catastrophic devastations that they merit little analytical attention beyond the statement that they are acutely toxic. What we must look for are sublethal effects, i.e. conditions which permit the survival of individuals and populations, but which cause long-term modifications in essential ecological characteristics such as rates of growth and reproduction, behaviour or important structures. These modifications and their consequences at the ecosystem level must be the focal point of modern ecological pollution research (Volume V).

Of course, sublethal effects are more difficult to determine, describe and analyse than are directly lethal ones. No wonder then that, thus far, most papers concerned with water-quality effects on fishes have concentrated on mortality studies at the individual level. Reviewing the pertinent literature on fishes, SPRAGUE has considered bioassay methods for determining acute toxicity (1969), the application of bioassay results (1970), as well as sublethal effects and 'safe' concentrations (1971). He points out that it is now possible to predict the toxicity of mixtures of 2 or more pollutants on the basis of chemical measurements, and stresses the fact that environmental factors and non-genetic adaptations may greatly modify the ultimate toxicity tolerance. For the ecologist, reproduction rate is the most sensitive and most significant criterion. The best bioassays can be produced through studies on community dynamics in restricted sea areas or in large plastic bags (Chapter 2, p. 73). The ecological meaning of changes in growth rate, swimming speed, respiratory and locomotory activity, and behaviour (e.g. feeding, avoidance reactions) is often difficult to interpret or remains entirely obscure. The ultimate method of a bioassay for environmental quality is field research.

In recent years, marine fishes, especially their eggs and larvae have been used increasingly for quickly estimating potentially detrimental effects of water pollutants. While the suitability of eggs may be limited due to changes in egg-membrane permeability during incubation, larvae provide excellent assay organisms. They are often available in great numbers, are small and usually sensitive to changes in environmental quality. Since water pollution and environmental protection receive detailed attention in Volume V, it must suffice here to refer to a few examples.

The tolerance of eggs of the herring *Clupea harengus* to different concentrations of cadmium has been examined by ROSENTHAL and SPERLING (1974) and VON WESTERNHAGEN and co-authors (1974); of eggs of the garpike *Belone belone* by VON WESTERNHAGEN and co-authors (1975); of eggs of the flounder *Platichthys*

flesus by VON WESTERNHAGEN and DETHLEFSEN (1975). The toxicity of oil to eggs and larvae of marine fishes has been documented, for example, by KÜHNHOLD (1969, 1972), that of oil dispersants by WILSON (1972, 1974). Herring larvae did not exhibit direct avoidance responses to dispersants, but tended to orient themselves towards clean water. Larvae which became narcotized in the dispersant layer sank into the clean water beneath. After recovery, they struggled upward again right into the dispersant layer.

Some sublethal effects of pollutants on marine fish eggs or larvae have been considered by ROSENTHAL and ALDERDICE (1976). These authors stress the high sensitivity of spermatozoa and unfertilized eggs to pollutants (e.g. several heavy metals, proteolytic enzymes of washing compounds); the permeability of capsular membranes, e.g. in the fertilized egg, for compounds that may interfere with the intermediary metabolism; and the lack of protective mechanisms in larvae. The need for investigating pollutant effects on spermatozoa and ova of marine animals has been emphasized previously by KINNE (discussion remark *in*: HALSBAND, 1968, p. 246).

The importance of marine fishes as food organisms for other cultivated animals has been referred to repeatedly throughout this subchapter, especially in regard to Crustacea (p. 742), and mammals (p. 1035). Fish eggs and larvae have been used as food also for lower invertebrates including the Cnidaria (p. 641) and the Annelida (p. 720).

(e) Pisces: Conclusions

During the last few decades, the cultivation of marine fishes has received considerable attention especially from mariculturists exploring the scientific basis of commercial farming projects. In spite of the efforts of hundreds of investigators, egg-to-egg breeding has been achieved only in a few cases. Long-term cultivation over several generations and true domestication have remained goals. The few exceptions reporting egg-to-egg breeding suffer from a low degree of predictability and reproducibility. As in many other marine animals, the factors truly critical to success have still to be analyzed in most cases. Several difficulties and problems encountered by the fish culturist parallel those outlined in previous sections. The interested reader is invited to consult especially the sections devoted to Copepoda (p. 761), Malacostraca (p. 808) and Mollusca (p. 884).

The two major difficulties primarily responsible for the limited success achieved in the egg-to-egg cultivation of marine fishes concern (i) the rearing of larvae and (ii) the provision of conditions conducive to natural gamete maturation and release under controlled conditions.

The rearing of fish larvae is problematic mainly because of the often specific nutritional requirements of the larvae and because of their very limited capacity for bridging even short periods of starvation, and inadequate environmental conditions (low capacities for regulation and adaptation). The food provided for the larvae must not only satisfy their nutritional demands, but also be presented in the right particle-size distribution and concentration. Absolute nutritional requirements of marine fish larvae have not yet been determined. The pertinent studies conducted on Protozoa (p. 584) and on several invertebrates (e.g. pp. 814–840) may stimulate similar work on fishes.

The concentration of food items which sustains maximum survival and growth varies with the species involved, larval age (size) and environmental factors such as light and temperature. Rapidly swimming hunters can often survive on lower food concentrations than slow swimmers. In general, young larvae require higher food concentrations than older ones. The latter command increased visual and locomotory capacities, are more experienced hunters, and may actively search for and stay in 'clouds' of supranormal prey densities.

Where minimum food-item concentrations have been determined in culture experiments, the estimates obtained were usually higher than average *in situ* concentrations. (Example: larvae of the anchovy *Engraulis mordax*; e.g. O'CONNELL and RAYMOND, 1970; HUNTER, 1972; HUNTER and THOMAS, 1974). Among the possible reasons for such discrepancy are (i) culture conditions (e.g. illumination) inadequate for proper recognition and capture of prey, for efficient hunting and learning; (ii) lower nutritional value of the food items offered under culture conditions; (iii) higher *in situ* prey catching efficiency, due to larval association with patches of food organisms with above-average food-item concentrations.

Since natural food for fish larvae is often not available—at least not in adequate quality (natural prey organisms in known, proper composition; absence of predators, competitors, disease agents) and sufficient quantity—it may be essential to train the larvae to accept food items which they would not normally eat under natural conditions (e.g. because of their appearance, movement patterns or taste). Ideal diets for larvae must accommodate the requirements of all stages; be reproducible in quality and available in sufficient quantity; have a long shelf life; and be easily administrable. Micro-encapsulated diets (e.g. p. 1373) could come close to meeting such rigid requirements. For most species, our knowledge of natural feeding behaviour and nutritional requirements is insufficient for designing ecologically meaningful experiments. We need more basic research in this as in many other fields of marine animal cultivation.

Other important aspects of fish larval rearing include (i) size, shape and colour of the culture enclosure; (ii) illumination, temperature, salinity, water movement and water quality; (iii) sequence of different food items provided in accordance with progressing growth and development. Culture enclosure, illumination, type of water movement and aeration must be selected in such a way as to prevent or minimize collisions between the larvae and solid objects or air bubbles. In many cases black or blue-green tank walls and optimum illuminance in the centre portion of a round or oval culture enclosure have proved to be beneficial.

Among the food items offered to captive larvae (Table 5-92), small zooplankters especially copepods (nauplii; copepodites) are most important; phytoplankters are less often eaten, but may be important as sources of vitamins and related life-supporting substances. The use of artificial diets as larval food remains to be fully investigated. While prey-catching behaviour and conditioning to proper sensory inputs have received some attention, more studies along these lines are encouraged. Antibiotic treatment may be important for disease control, but possible side effects of the antibiotics used which may interfere with normal growth and behaviour, as well as with stress and disease resistance of the larva, require critical analysis.

Natural gamete maturation can often be conditioned by providing appropriate light and temperature regimes. However, successfully conditioned fish may ulti-

mately fail to spawn—apparently because of lack of essential stimuli (e.g. from conspecifics or other organisms or from non-living objects). Where natural maturation failed to occur, artificial means (hormone injections) have been used for inducing gamete maturation and spawning. While the importance of hormone injections is rather limited for elucidating natural behaviour and reproduction, such injections open up new perspectives for the fish farmer. Many fishes which have consistently refused to spawn in captivity can now be forced through maturation and spawning (or at least be stripped after successfully induced gamete maturation). We need to know more about the natural feeding behaviour of marine fishes and about the key stimuli which initiate natural spawning.

Success in larval rearing and controlled breeding opens up new possibilities for (i) solving a variety of ecological problems, (ii) life-cycle studies, (iii) controlled production of eggs, larvae and juveniles used for experimentation or as seedlings for farming, (iv) genetic analyses and selective breeding (stock improvement).

(14) Mammalia

(a) General Aspects

The relationship of man to marine mammals in general and to dolphins and whales in particular has been characterized for centuries by curiosity, sympathy, admiration and superstition. Dolphins and whales have left ineradicable marks in history books and in the phantasies and folklore of numerous peoples. Folklore has also built up around river dolphins. Thus natives along the Amazon river hold the boto *Inia geoffrensis* responsible for all otherwise inexplicable births.

'This seems rather a good solution for all parties involved, and the father of the child is dutifully recorded on birth certificates . . . as boto' (CALDWELL and CALDWELL, 1969).

Marine mammals—particularly their holoaquatic representatives—have long remained the least-known large animals on earth. This is now changing. The dependence of whaling on ecological knowledge (maximum-sustained-yield hunting) and the interest in underwater navigation, communication and locomotory hydrodynamics, as well as in the ecological role of these large predators has—supported by our increasing capability to cultivate marine mammals—produced a fast growing, impressive amount of information.

Members of all 5 orders of marine mammals—Carnivora, Pinnipedia, Sirenia, Mysticeti and Odontoceti—have been kept in captivity. However, more than 95% of the cultivated representatives have been pinnipeds or odontocetes. The present account is, therefore, restricted to these two orders. Carnivora are represented in oceans and coastal waters by 1 species only: the sea otter *Enhydra lutris* (Volume II, Chapter 8.3); Sirenia have been accommodated in captivity very recently, and the information at hand is still rather incomplete. Of the Mysticeti, only three individuals have been sustained in captivity for brief periods of time: a yearling grey whale *Eschrichtius robustus* for several months by Sea World (San Diego, USA), and 2 juvenile minke whales *Balaenoptera acutorostrata* by Nakanoshima Aquarium and Mito Aquarium (Japan) for a few days and 37 days, respectively.

Most marine mammals sustained in captivity are exhibited to the public. They are often primarily considered as 'money makers'. This has led some owners, shareholders and managers to visualize animal care, mortality and facilities solely as business parameters and to largely disregard the natural requirements of their captives. Research was frequently considered a nuisance unless it helped to make more money, and economical interests have sometimes hindered the free exchange of scientific knowledge related to the keeping of marine mammals. In recent years, this state of affairs and over-exploitation due to often ruthless fishery practices has prompted a number of marine ecologists, zoo directors, veterinarians and conservationists to persuade the governments of major fishery countries to pass protective legislation. Both the killing and the capture, transport and maintenance of live marine mammals are now increasingly controlled by protective rules and laws. An example of protective legislation is the 'Marine Mammal Protection Act of 1972' (US Public Law). We refer to some essential points of protective rules for captive marine mammals in the sections *Capture*, *Transport* and *Environmental Requirements*.

Marine mammals are not only endangered due to killing and capturing by man—they also suffer increasingly from man-made sea-water pollution, especially from heavy metals (mercury, lead, cadmium) and chlorinated hydrocarbons (PCB, chlordane, dieldrin, DDT, DDD, DDE; e.g. HOLDEN 1975; TARUSKI and co-authors, 1975). For details regarding the pollution of marine environments consult Volume V.

Many Pinnipedia and Odontoceti, kept in marine mammal facilities, have been referred to in Volume II: KINNE (1975) in regard to orientation mechanisms, and in KINNE (in press) in regard to diseases. In the present section, we concentrate on capture and transport of live individuals, adjustments to captivity, environmental and nutritional requirements, as well as on some aspects of reproduction.

General accounts which include information on marine-mammal cultivation have been presented by CRANDALL (1964), NORRIS (1966a), CALDWELL and CALDWELL (1968), RIDGWAY (1972a), WOOD (1973), RONALD and MANSFIELD (1975), and WALKER (1975).

(b) Capture

The capture of wild pinnipeds and odontocetes for zoos, dolphinariums, oceanaria or special research facilities is an attractive business for specialized fishermen. Hence, details of the techniques employed for capture as well as the catching sites are sometimes considered a secret. However, the principal methods have become known and are briefly described below. They vary as a function of the species concerned, the size of the individual to be caught, the geographic location and the topography of the capture site.

Wherever possible, a mammal should be observed for a while before an attempt is made to catch it. This may condition the animal to human presence and allow the working out of strategical details for the capture process. If the first trial to capture the mammal fails, the difficulties may increase considerably. The problems encountered in capture and transport multiply with mammal size and weight. Particular care must be exercised to protect eyes, and extremities.

The capture of stranded marine mammals for purposes of cultivation must be discouraged. Stranded individuals are usually sick beyond help. The chances for recovery are extremely low, but the stranded individual may introduce dangerous disease agents into the culture system.

The capturers usually select the mammals caught according to size and external appearance. For most species, certain sizes have turned out to be able to adjust more easily to captivity than others (e.g. ASPER, 1975; WALKER, 1975; see also the section *Adjustments to Captivity*). WALKER points out that pilot whales under 274 cm (9 ft) in length are too young and those larger than 457 cm (15 ft) too large for transport; the best size for transport and acclimation purposes ranges from 300 cm to 460 cm. The external appearance must be 'clean', i.e. without excessive scratches, skin lesions or scars.

Pinnipeds

Pinnipeds have been netted or trapped on land, while moving from land into the water or while in water. In general, netting methods have been used which are similar to those described under *Odontocetes* (p. 1039). In many cases, herds or single individuals have been (i) slowly herded to prepared capture sites; (ii) separated from the water's edge by running or driving down the beach and spreading out a net before the mammals could enter the water; (iii) rapidly paying out a seine net in the water adjacent to the resting site from a speed boat. Herding and chasing must be done with care. Heavy physical exercise on land may cause fatal overheating in fleeing individuals, especially in warm weather.

Pinniped herds resting on land have been slowly herded away from the water to prepared traps or fenced-in areas. RIDGWAY (1972b) describes a technique whereby several personnel work themselves carefully into a position between the pinnipeds and the water, and then slowly move toward the group selected. If this is done with caution and without the herd getting alarmed and beginning a frenzied rush to the water, the mammals are relatively easy to herd away using sticks, jackets or bags. Once the group is driven far enough away from the beach and is sufficiently calm, all individuals not wanted are allowed to return, while the ones desired are retained and placed in cages. Small individuals (less than 35 kg) are grabbed and lifted into the cage; larger ones are herded directly into the cage or, if this does not work, first hoop netted or entangled in a net and then lifted by several men.

Where pinnipeds rest on a steep bank, they can be trapped by coast-parallel nets—installed at the foot of the bank slope and quickly raised, thus retaining fleeing individuals (Fig. 5-112). PAULBITSKI and MAGUIRE (1972) have captured harbour seals *Phoca vitulina* in this way. They used 3 pairs of tennis nets, lashed together and supported by metal frames and wooden doweling. The nets were placed on the sea floor and, upon a signal, raised by 8 men, each pulling on one of the 8 ropes attached at intervals to the net. While this method worked quite well, net installation and removal were time consuming and many people were required for the operation.

Odontocetes

Odontocete whales have been caught alive by hand, snares, anaesthetic dart guns, skin harpoons and, most often, by nets. In some cases, use has been made of the

fact that cetaceans stay with wounded or captured individuals or approach these from considerable distances, possibly guided by distress calls (Volume II, p. 812). Some capturers have strapped an odontocete to a line or have simply left it in a net cage and then caught the 'rescuers' as they approached. Whalers have left wounded individuals in the water in order to attract others for the kill.

While repeated attempts to catch a beluga *Delphinapterus leucas* gone astray in the River Rhine failed, mainly because of the deep water (GEWALT, 1967), capture by hand was successful near Churchill (Canada), after driving belugas into very shallow water by motor boats (GEWALT, 1970). Since numerous rocks prohibited the use of nets, a man jumped on the whale from a boat, riding and holding it until others arrived, or several men waded toward a group of almost stranded whales, selected the individuals to be transported, manoeuvred them on a stretcher and rolled them on a transport boat. In very shallow water, delphinids are usually calm and tolerate handling without resistance. In addition to riding them, GEWALT has caught belugas in shallow water by employing a 'bear hug with a wristlock'.

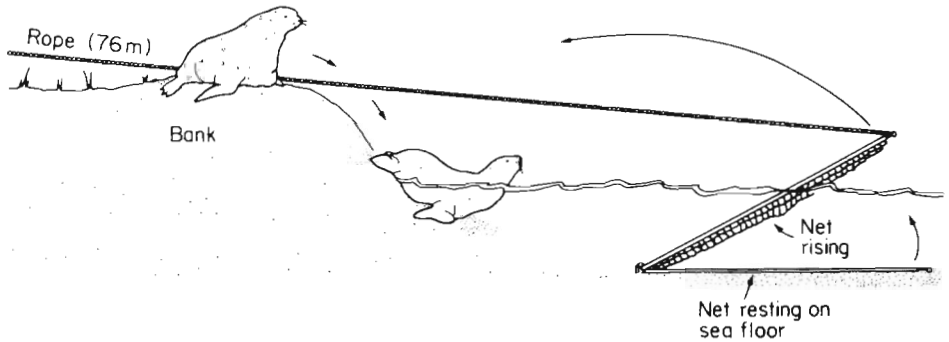

Fig. 5-112: Capture of harbour seals *Phoca vitulina* on a steep bank. (Based on PAULBITSKI and MAGUIRE, 1972.)

Care must be taken not to grab an odontocete by the fluke or by the ends of its flippers. This could cause a dislocation or break of extremities (RIDGWAY, 1972b).

Head snares and tail snares (head or tail grabbers) typically consist of a long stick secured by a line and ending in a noose; they are used to catch odontocetes with appropriate head or tail structures, with a dorsal fin and with sufficiently rigid skin. In the beluga *Delphinapterus leucas*, for example, snares do not work well. They often find no firm hold and 'you wind up holding a beluga by the tail' (RAY, 1966, p. 650). Capturing a whale from the bow of a ship with a tail snare will tend to pull the tail upward and when the whale fights and attempts to dive, it may not be able to respire properly and, consequently, may drown (NORRIS, 1966b).

Snaring of pilot whales *Globicephala scammoni* has been described by BROWN (1962). For the first 35 minutes after becoming ensnared, a 5.26-m long male towed the collecting boat in large circles. The male exhibited a tendency to dive and then rest at the end of each dive, leaving the line quite slack. It was brought alongside the boat by winching-in the nylon lead rope. A rubber life raft was then pulled beneath the whale and quickly inflated. Thus 'stranded', the male made no movements and could be safely towed to the nearby port.

Anaesthetic dart guns have been used in a few cases. Their application is still problematic. According to NORRIS (1966b), most dolphins died very shortly after receiving anaesthetic shots. In all cases, survival rates were so low that the method has been largely abandoned. However, once a proper chemical formula has been worked out for the anaesthetic, as well as a suitable dosing key, hypodermic anaesthetic guns may turn out to be a useful instrument for the whale catcher. In a variety of captive mammals, Sernylan® 1-(1-Phenylcyclohexyl) piperidine.HCl has been shown to be effective (intramuscular, intravenous or oral) in producing sedation, tranquillization, analgesia and anaesthesia to deep narcosis (KROLL, 1962). Doses and timing for pinnipeds are cited in Table 5-114.

Table 5-114

Sernylan® application (intramuscular) to pinnipeds (After KROLL, 1962; modified; reproduced by permission of Zoological Society of London)

Species	Dose mg kg ⁻¹ body weight	Time required to produce immobilization (mins)	Time elapsed from inoculation to recovery	Comments
<i>Callorhinus ursinus</i> Northern fur seal	0.5	7	40 mins	None
<i>Mirounga angustirostris</i> Elephant seal	1.0	17	4 hrs	Salivation; tears
<i>M. angustirostris</i> Elephant seal	1.5	13	4 hrs 30 mins	Salivation; tears
<i>Phoca vitulina geronimensis</i> Harbour seal	0.5	25	41 mins	None
<i>P. vitulina geronimensis</i> Harbour seal	1.0	11	1 hr 16 mins	None
<i>Zalophus californianus</i> California sea lion	1.0	12	2 hrs 11 mins	None

Skin harpoons are small replicas of normal hunting harpoons. As soon as their tip has penetrated the skin, it turns or bends aside thus avoiding lethal injury. Since most odontocetes have relatively thin skin, they cannot be skin-harpooned. Only *Delphinapterus leucas*, the narwhal *Monodon monoceros* and related forms with thick, leathery skins can be captured by skin harpoons (RAY, 1966). However, the harpoon method often inflicts considerable injuries and cannot be recommended for catching marine mammals to be cultivated.

Netting methods are superior to most other techniques and have been employed in the majority of cases. We may distinguish small nets enmeshing the body of individuals (i.e. the bag-like hoop net and the throw net), and large nets surrounding groups or small herds (i.e. purse seine, gill nets and trap nets). Hoop nets and throw nets can be used for open-ocean captures. In the case of the hoop net, the operator works from a pulpit secured to the bow of the capture boat. When a dolphin riding the ship's bow blows, the hoop net is placed so that the dolphin swims into it. As

soon as the netted dolphin dives, a buoy attached to a line is thrown overboard and retrieved when the animal surfaces again. Now divers jump into the water and attend to the dolphin while it is towed closer to the boat (RIDGWAY, 1972b). After strapping and placing in a hammock-like sling (p. 1046), the dolphin is hoisted aboard, accommodated on a thick foam-rubber mattress and covered by sea-water soaked towels.

In southern Californian waters, common dolphins *Delphinus delphis*, Pacific white-sided dolphins *Lagenorhynchus obliquidens*, bottle-nosed dolphins *Tursiops* sp. (*gilli?*), Northern right-whale dolphins *Lissodelphis borealis*, Dall's porpoises *Phocoena dalli* and short-finned pilot whales *Globicephala macrorhyncha* have been captured by the break-away-hoop-net method. (WALKER, 1975; see also WOOD,

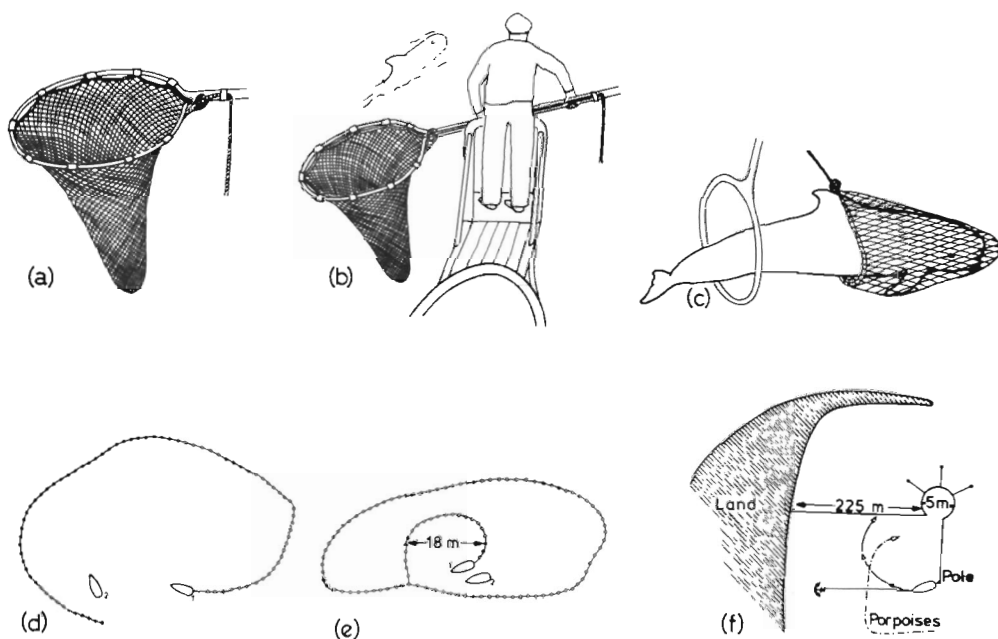

Fig. 5-113: Methods for capturing odontocetes. a-c: Break-away-hoop-net method; d, e: seine-net method; f: trap-net method. (Original.)

1973). As shown in Fig. 5-113a, in this method, the net is attached to the hoop with tape (or any other material strong enough to hold the net on the hoop, but weak enough to break away when the mammal passes through; ASPER, 1975). The break-away-hoop net is placed over the surfacing whale's head (Fig. 5-113b, c). Tension on the capture line purses the net in front of the dorsal fin, enmeshing head and flippers, but allowing full fluke mobility. Hence, the captured odontocete can still manoeuvre, surface and respire. The hoop must be of sufficient diameter to avoid injury.

Delphinus delphis is easy to capture. WALKER (1975) gives the following description. As soon as a herd is sighted, the capture boat is manoeuvred so as to approach the herd from behind, and the speed set to slightly overtake the dolphins. The boat is then directed through the centre of the herd travelling in the same direction.

Under these conditions, the dolphins tend to ride the bow for the greatest length of time. The capture of an individual disturbs the herd members apparently only for a short time at the most. In contrast to *D. delphis*, *Globicephala macrorhyncha* is quite difficult to capture. It is larger and does not bow-ride. Hence, the collecting boat must be equipped with a bow extension, where the collector waits for the chance to pull a large break-away-hoop net over the surfacing whale's head (Fig. 5-113b). Once netted and brought alongside the boat, the whale is accommodated on a stretcher and lifted aboard. The main problem in capturing *Phocoenoides dalli* is, according to B. FALCONE (personal communication to WALKER, 1975), its extreme power relative to its size. Typically, *P. dalli* is caught when swimming at high speed at an angle to the collecting boat's bow. This procedure may cause injury and a frenzied state. Hence, newly caught individuals had often to be lowered again into the sea in a stretcher in order to calm down sufficiently for subsequent transport. For further details consult WALKER's review.

Enmeshing has also been achieved by throwing a net with weights attached at its periphery over an individual or a small group. The mammals thus caught often entangle themselves to an extent where locomotion becomes severely hindered. They are then joined by catchers who prepare them for lifting on a stretcher or in a sling. Light nets may be shot from a gun—a technique used with great success for catching birds.

Purse seines or gill nets are employed to catch forms such as *Tursiops truncatus*, *Delphinapterus leucas* or *Orcinus orca*. As has already been pointed out, these odontocetes are usually captured while in shallow water or after driving a herd into bays or estuaries. Herds of *Stenella caeruleoalba*, for example, can be easily chased by boats into a bay. The men in the boats slap the water surface with paddles, throw stones or beat a trumpet-shaped device designed to produce underwater noise (NISHIWAKI, 1972; see also GEWALT, 1971, and Volume II: Fig. 8-104, p. 800).

The seine-net techniques is considered by ASPER (1975) to be the most efficient and humane method for capturing live dolphins such as *Tursiops truncatus* in shallow waters. According to ASPER, the seine net most commonly used is 36.6 m (400 yards) long, 7.3 m (24 ft) in depth and constructed of 52-gauge nylon with a 20-cm (8 in) stretch mesh. The floats supporting the net upright in the water must be of suitable size and the line heavy enough to assure that the net touches the bottom. The boat paying out the net must be capable of maintaining a speed of 35 knots with full gear aboard. The cooperation of 2 boats and a spotter plane has turned out to be very effective. While the dolphin herd is encircled by Boat 1, Boat 2 follows the set, watches for overlaps in the net and for dolphins that may become entangled prematurely (Fig. 5-113d, e). Once the inner circle is closed to a diameter of some 8 to 12 m, the dolphins begin to strike the net; the float line is then pulled in, and the enmeshed dolphins brought alongside, one after the other.

Orcinus orca have been caught by a gillnet or table seine up to 1.6 km long and 48 m deep (BIGG and WOLMAN, 1975). After the whales had entered a bay, escape routes were blocked by setting the net quickly either across the mouth of the bay or directly around the pod. Once a pod has been trapped, additional nets are laid for reinforcement and anchors are set to keep the nets in place. The main locations for capturing *O. orca* in British Columbia are, according to BIGG and WOLMAN, Pender Harbour and Pedder Bay; in Washington, Penn Cove and Carr Inlet (Puget

Sound). These localities are situated along the routes travelled by *O. orca* in waters less than 35 m deep and with weak tidal currents.

Netting from land has been used for a long time. A herd is either encircled by a very fast boat (major problem: to pay off the net rapidly enough), or a net trap is set before a herd arrives. According to NORRIS (1966b), a small-mesh, light-weight net is used; if necessary, the mammals are then encircled again with a heavier net which is slowly pulled ashore.

Once surrounded by a net, few, if any, odontocetes attempt to break the net or to jump over its margin. Most stay within the encircled area and gradually calm down. They are then individually caught with a small net enveloping their body and lifted out of the water on a sling or stretcher.

RAY (1966) used the seining technique and employed Eskimo hunters for capturing the beluga *Delphinapterus leucas*. He gives the following description: All catching operations were restricted to calm days. Otherwise it would not have been possible to follow a whale, because underwater visibility was only about 1.3 cm. The wake just behind the shoulder and the little puddles left by the tail beating up and down betrayed the whale's escape route and enabled the hunters to direct the beluga into shallow water. At a water depth of ca 1.2 m, a man went into the water, grabbed the beluga, and strapped it just behind the flippers at the tail using a soft strap—not a rope which would cut the skin—and guided it to the transport boat. After a padded board had been placed under the whale, it was lifted, slid into the boat and covered with wet cotton muslin.

Trap-net arrangements moored with poles have been used for capturing harbour porpoises *Phocoena phocoena* in Danish waters (Fig. 5-113f). The porpoises are chased into the trap by slapping branches firmly on the water surface. As soon as the mammals have passed the anchor line, the net boat moves shorewards paying out the closing net. By taking the net in, the porpoises are forced to enter the pond net from where they can be collected by lifting the net bottom (DUDOK VAN HEEL, 1962; see also ANDERSEN, 1974a). As with other delphinids, *P. phocoena* is easier to capture in shallow than in deep water. In contrast to DUDOK VAN HEEL who reported *P. phocoena* to be very sensitive to handling and to often go into lethal nervous shock, ANDERSEN and DIEDZIC (1964) found this porpoise to be rather robust and not to suffer from heavy shock after capture, but they state that *P. phocoena* is easy to frighten, even after 8 months in captivity. Apparently, there exists considerable variation in the responses of different individuals: some do not resist when taken out of the water, while others fight ferociously. Much depends on the strategy of the capturers; it seems best to drive *P. phocoena* into very shallow water, to avoid seizing it by its tail and to allow a calming-down period before lift-up and transport.

Rules

The rapidly increasing demand for marine mammals by zoos, circuses, oceanaria, marinelands and other exhibits, the money-making potential of these animals, and the often insufficient knowledge and responsibility in regard to proper handling and care have created a need for law-enforced rules. Of the countries involved in the

capture of live pinnipeds or odontocetes, several have passed protective legislation. In the USA, a very detailed 'Marine Mammal Protection Act of 1972' (Public Law 92-522) has practically halted all misuse, but has also restricted experimental marine-mammal research.

Important aspects of protective rules include the following: (i) All capture activities planned must be made known to and permitted by local control agencies. (ii) Regardless of the success of the capture, a form must be completed providing information on the species and number of individuals captured, the approximate number of herd members hunted, and the number of individuals inadvertently injured or drowned. (iii) All captured individuals must be marked (e.g. by deep-freeze branding or explosive branding: e.g. HOMESTEAD, 1971). For all future trans-

Table 5-115

Minimum body length (cm) for capture and transport of odontocetes (After DUDOK VAN HEEL, unpublished)

Species	Body length (cm)	Species	Body length (cm)
<i>Delphinus delphis</i>	120	<i>Pseudorca crassidens</i>	260
<i>Globicephala</i> spp.	260	<i>Sousa plumbea</i>	180
<i>Grampus griseus</i>	200	<i>Stenella longirostris</i>	120
<i>Lagenorhynchus obliquidens</i>	150	<i>Tursiops aduncus</i>	180
<i>L. obscurus</i>	150	<i>T. truncatus</i> (Gulf of Mexico)	180
<i>Orcinus orca</i>	330		
<i>Phocoena phocoena</i>	100*	<i>T. truncatus</i> (western coast of Europe, Mediterranean Sea, African coasts)	210

* S. ANDERSEN (personal communication).

ports and reports (e.g. on health, birth, etc), reference must be made to the marking. (iv) Capture procedure and local transport must avoid undue stress or harm. (v) It is not allowed to capture females or suckling juveniles, to capture undersized individuals (Table 5-115), or to capture individuals of endangered species. (vi) Wounds incurred during capture require immediate treatment.

(c) Transport

The amphibious Pinnipedia are easier to transport in air than are the holoaquatic Odontoceti. The latter are adjusted to permanent life in water. Their supporting structures tend to collapse during in-air transport. This may lead to impairments of normal respiration, blood circulation and digestion. The degree of the stress

incurred increases as a function of body weight. Hence, in-air transport of odontocetes requires special attention and must be as short as possible. In a letter to the reviewer (1976), R. J. HARRISON writes:

'The worst trouble associated with transport out of water is the lack of buoyancy. This causes lung collapse, or inadequate ventilation, stasis, infection and subsequent lung abscess, mediastinal abscess, etc. In my opinion, large cetaceans should not be transported out of water—not even if upside down—for this reason.'

Both in pinnipeds and odontocetes, normal heat loss through the blubber coat is reduced in air—a fact that may cause critical overheating, especially during warm weather and after prolonged excitement. Water sprinkling, water sponging, ice packings and free air access effectively counteract overheating. Sudden temperature decrease or draught must be avoided.

Proper weight distribution of sling-transported odontocetes, gentle handling, soft speaking and stroking are usually effective in calming nervous individuals. Where necessary, tranquillizers may be used. GEWALT (1969, 1970), for example, injected newly caught belugas *Delphinapterus leucas* 10 cm³ of Combelen per ca 400 kg body weight. He attempted to reduce infection and stress by administering injections composed of: Tardomyocel (3.2 million I.U.), 17.3 ml; Voren, 16.7 ml; Ad₃ e-turin, 8.0 ml; Myofer, 5.0 ml; B₁₂ (Friesoythe), 5.0 ml. In Kamogawa 'Sea World' (Japan) and in several other oceanaria, newly captured odontocetes, especially sensitive forms such as *Stenella caeruleoalba* and *S. attenuatus*, are given the tranquillizer Chlorpromazin. S. ANDERSEN (personal communication) has used Stesolid (a Benzodiazepin derivative), 10 mg for each 20 kg of *Phocoena phocoena*, and obtained a pronounced sedative effect. However, HARRISON (personal communication) warns:

'Avoid tranquillizers unless absolutely essential. They disturb temperature-regulation mechanisms and can cause loss of the animal unless most careful monitoring is done. The most devastating criticism of administering drugs to marine mammals is that not a single trial has been undertaken let alone published. The statements available are entirely empirical.'

Animals transported from distant areas may introduce disease agents and other organisms previously unknown to their area of destination. Such translocation of organisms may affect the local ecosystem. For details on organismic translocation and potential effects on ecosystems consult Volume V.

Pinnipeds

Pinnipeds are transported in air. Newly caught individuals may first be accommodated in a restraining device to prevent injury to the animals or to the captors. An example of a simple restraining device used for seals is illustrated in Fig. 5-114. Restraining cages for sea lions have been employed and described by RIDGWAY (1972b). Some restraining cages facilitate strapping the pinniped to the cage bottom; subsequently, the upper cage part is removed and the strapped individual transported on the cage-bottom board.

During transport, pinnipeds are placed in relatively small containers which usually consist of a smooth wooden floor and lattice sides and top (Fig. 5-116). Sufficient air access and a moist body surface are essential for avoiding overheating. During long-distance transport, pinnipeds should be moistened with a sponge or by dripping water on them.

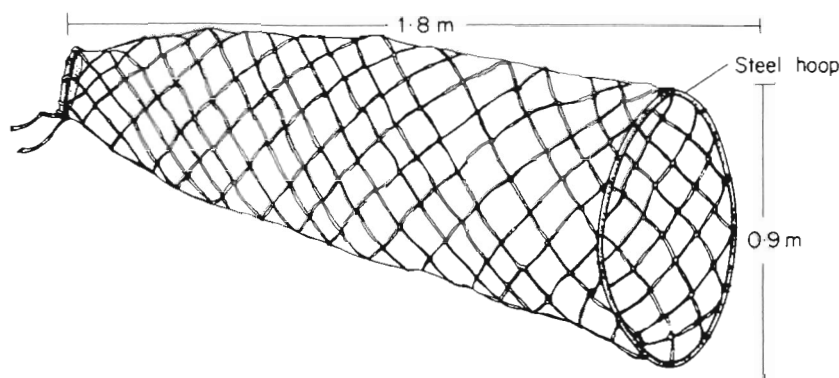

Fig. 5-114: Restraining device for newly caught seals. (Based on POULTER, 1965.)

Odontocetes

A few instances of live odontocete transport date back centuries. In 1558, RONDELET (in LEE, 1878) described long-distance dolphin transport from Languedoc to Lyons (France). Apparently the dolphins were transported alive in order to postpone putrefaction of their later eaten meat. According to LEE (1878), white whales *Delphinapterus leucas* were transported in a box on wet seaweed and accompanied by an attendant who continuously moistened the blowhole during the long journey.

In 1877 and 1878, *D. leucas*, caught at the coast of Labrador, were shipped to Montreal (Canada) and from there in a 14-day (!) train journey to New York, where they remained for some time in a small tank at the Coney-Island Museum. On September 15, 1877, one individual was shipped to Southampton (England), arriving September 26, and subsequently transported by rail to London. It survived this long, strenuous trip but 4 days.

In principle, odontocetes have been transported both in water and in air, but in-water transport has serious drawbacks and has been practically abandoned (see below). For in-air transport from the catching site, motor boats are used with an open stern and a double bottom, covered by a thick foam-rubber mattress (SANTINI, unpublished). Both the upper bottom and the mattress have two slits to accommodate the flippers. In large individuals, care must be taken to support the fluke properly.

Transport of odontocetes in small water-filled (transparent) boxes (TOWNSEND, 1914; LILLY, 1962; WILKIE and co-authors, 1968) has been abandoned because:

(i) water-filled boxes are very heavy and difficult to handle; (ii) the narrow solid-wall confinement often causes injuries; (iii) water sloshing due to transport-vehicle movements may cause respiration problems (and damage to the transportation vehicle); (iv) the water quality rapidly deteriorates due to pollution (urine, faeces); (v) the mammals transported may develop aspiration pneumonia.

Floating pens, slowly towed by a ship, have been used, for example, by DUDOK VAN HEEL (1962) for transporting the harbour porpoise *Phocoena phocoena* over short distances, and by GRIFFIN (1966) for transporting a 5-ton killer whale *Orcinus orca* over some 724 km. Odontocetes usually avoid contact with the pen netting and stay near the centre during transport. Floating-pen transport is expensive and restricted to unpolluted water routes.

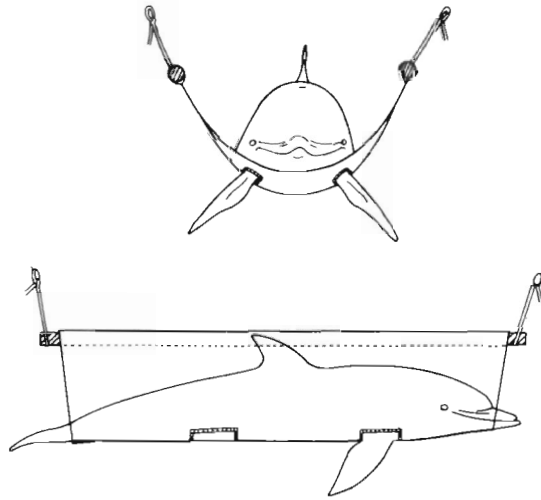

Fig. 5-115: Pole-sling method for supporting a dolphin during in-air transport. The sling must not squeeze the thorax sides. (After WILKIE and co-authors, 1968; reproduced by permission of the Zoological Society of London.)

For in-air transport, anatomically well-designed soft body supports are essential. The support must be light for air travel, solidly designed to meet safety requirements, and made of a material which facilitates air ventilation.

During in-air transport, odontocetes have been accommodated in boxes or in hammock-like slings. The box developed by M. SANTINI (*in*: DUDOK VAN HEEL, 1972) consists of plywood, is watertight and has a double bottom with a thick foam-plastic or rubber mattress on top. Mattress and upper bottom have holes which allow movements of the flippers. Straps keep the animal in place should it panic or during excessive movements of the transport vehicle. DUDOK VAN HEEL lists the following disadvantages of the Santini box: (i) heaviness and expensiveness; (ii), insufficient ventilation; (iii) danger of overheating of body parts immediately in contact with the mattress; (iv) inaccessibility of flippers and lower body during transportation; (v) no opportunity for taking rectal temperatures; (vi) a thrashing

dolphin can hurt itself considerably in the narrow box. The box has a battery-driven pump which sprinkles the dolphin's body surface, but the recycled water rapidly becomes contaminated due to excretion.

Pole slings (Figs 5-115, 5-117) are now considered the best transportation equipment for odontocetes. The canvas slings have two holes to accommodate the flippers at a normal angle, as well as genital and anal slits to allow the drainage of urine and faeces. The slings are placed in support frames, lined to hold dripping water and metabolic waste. In order to prevent critical skin dehydration, body, dorsal fin and flippers are covered by terrycloth (Fig. 5-117), which is kept moist. Where necessary, tail flukes, flippers or even the entire body may be cooled by ice packings; this may be essential when shipping cold-water forms, for example, the killer whale *Orcinus orca* (IRVINE, 1970a; PRESCOTT, personal communication) and the beluga *Delphinapterus leucas* (GEWALT, 1971).

Several workers have advised the use of padded slings in order to reduce or avoid abrasions and sores. Abrasions have occurred around the chin, at the tail stack and in the axillary region (RIDGWAY, 1972b). They cause discomfort and provide access for infection agents. However, padding reduces ventilation and often causes local overheating resulting in burns of the body underside (e.g. WILKIE and co-authors, 1968). Hence, most experts now use heavy canvas slings which facilitate evaporative cooling. In order to counteract abrasion, padding is provided on the sling margins, including those on the slits accommodating the flippers. Examples of skin lesions and lacerations due to excessive local pressure during transport have been reviewed and discussed by GREENWOOD and co-authors (1974).

The pole sling developed by WILKIE and co-authors (1968) is made from 8 oz canvas. The poles are suspended with ropes and stretched far enough apart to reduce the pressure on the sides of the thorax and thus to facilitate respiratory movements. WILKIE and co-authors recommend monitoring heart rate and deep rectal temperature during transportation as a means of evaluating the odontocete's conditions. In an experiment, a *Tursiops truncatus* exposed to sling conditions for 24 hrs lost 6 kg in weight during this period; its heart rate slowly increased from 58 beats min^{-1} to 101 beats min^{-1} ; the rectal core temperature remained near 37° C. Returned to the water, the dolphin swam normally and immediately consumed 6.8 kg of fish. During the ensuing weeks no signs were observed of any delayed negative effects.

The following detailed recommendations for long-distance transportation of bottle-nosed dolphin *Tursiops truncatus* are based on many years of experience accumulated by DUDOK VAN HEEL (1972): (i) Use unpadded slings of heavy canvas. (ii) Soak sling prior to transportation in clean sea water. (iii) When catching the dolphins in their holding tank, take care that no water enters their lungs; water in the lungs increases the chance of lung infection. (iv) As soon as the skin begins to dry, grease it all over with lanoline to prevent dehydration until the dolphin 'looks like a beluga'. (v) Fit each dolphin in a sling, evenly distributing its body weight. (vi) Spread a sea-water-soaked canvas cover over its body; then drive immediately to the airport and load the dolphins. (vii) During transport, check body temperature rectally (normal rectal temperature: ca 36° to 37° C; extremities should be much cooler); avoid both overheating and overcooling; usually the wet sling and body cover exclude overheating; overcooling (e.g. during transfer from

plane to cargo building in cold weather) is counteracted by plastic sheets or by application of warm water. (viii) As soon as the dolphins have quietened down, the poles (handle-bars) of the sling are shifted outwardly thus opening the sling and allowing more freedom for movement. The dolphins can now roll a little bit from side to side, and lift their heads; such movements assist blood circulation; if the dolphins get too nervous and start thrashing, the handle-bars are shifted towards each other. (ix) Signs of irritation often signal that a shift in body position is obstructing flipper movement. In such a case, the dolphins must be moved a little backwards or forwards or rolled, thus making them comfortable again. Two attendants are required for this. (x) During transportation, use very little water; keep skin and cover moist, not wet. For body wetting, preferably use a sponge soaked in water. Wait until the dolphin has respired before wetting its head region. Always warn the animal that you intend to touch it by showing yourself first, talking, and stroking the dorsal side between blowhole and dorsal fin. Dolphins do not like to be touched on their extremities. Be careful with sprinkling water over the dolphin. (xi) When the dolphins are very quiet, spread plastic sheets loosely over the support frame to keep a moist atmosphere; remove plastic sheets at intervals to insure air exchange. (xii) Remove excessive faeces and restore lanoline layer where necessary.

During transport, dolphin containers cannot, of course, be stacked on top of each other. DUDOK VAN HEEL (1972) arranges his pole slings at right angles to the freight aeroplane's longitudinal axis. When placed lengthwise in the plane, the dolphins may slide forwards or backwards in their sling and may receive skin abrasions or even cuts in their flippers; in a box, they may hit the front end and hurt their snout. Since a lorry is usually too narrow for sideways storage, a careful driver and two attendants are a must. Only in a closed lorry can the temperature be sufficiently controlled and excessive draught be avoided. Over long distances, the driver should stop every 30 mins for checking. During aeroplane transportation, DUDOK VAN HEEL and TIEBOR (1966) observed signs of shock in *Tursiops truncatus* and *Lagenorhynchus obliquidens* when the air pressure suddenly dropped below the equivalent of 1524 m (5000 ft). When transporting *T. truncatus*, DUDOK VAN HEEL (1972) uses the anterior portion of the plane which is most comfortable in terms of movement and noise; this allows his transport to get in last and leave first, and to establish quick contact with the crew in an emergency. He always tries to stay with the dolphins during take-off and landing. Shipping dolphins in the belly of commercial passenger planes should be avoided; no attendants are allowed, and the bellies have usually less than 1.5 m headroom. Sometimes, aeroplane-transported dolphins open their mouths repeatedly and release a slimy substance. Whenever this happens, DUDOK VAN HEEL (1972) washes the mouth with sterilized water and lifts the head a little.

According to FELTS (1966), air suspension, used for burn patients, might also be applicable for supporting a transported cetacean. The whale would have to be covered by a low-pressure jacket serviced by a pump. The air intake could be sterilized, humidified and medicated, thus providing a controlled skin environment. Further research is required for assessing the significance of air-suspension methods in the transport of odontocetes.

At their final destination, the dolphins are immediately unloaded and the covers removed. The animals are then carefully lifted, one by one, into a shallow, sea-water-

filled tank, where one or two attendants are ready to walk each dolphin around and to help it overcome stiffness after long-term travel. As soon as the dolphins are breathing and swimming normally, usually 10 to 15 mins after being allowed to roll out of their slings, a light meal of 1.5 kg is offered.

Especially after very long journeys (25 to 30 hrs) and in the case of weak individuals, the water in the tank is initially maintained so low as to facilitate easy handling (e.g. care of wounds, infected skin areas or eyes; force-feeding). If necessary, the water should be drained for such purposes.

In several cases, odontocetes newly released into a culture tank have been observed to float on the water surface for hours or even days before they resumed normal swimming. After release into an exhibition tank, a male pilot whale *Globicephala scammoni* quickly dived and began to swim slowly in a head-down position, his snout tip only several centimetres from the tank floor (BROWN, 1962). Interrupted only for blowing, the male maintained this posture for several hours (see also p. 1050). For details on capture and transport of *Platanista gangetica* consult PILLERI (1970).

Rules

General rules for transporting marine mammals include the following points: (i) Transport must be permitted by a control agency. (ii) Transport time and frequency have to be reduced to a minimum; in odontocetes, repeated transport leads to stress syndromes which may cause death. (iii) Allow newly captured mammals to adjust to captivity conditions, to food and human presence for 1 to 4 weeks prior to long-distance travel; for this purpose, suitable temporary holding facilities (e.g. pool on land or pen in water) must be available. (iv) Stop feeding 8 to 24 hrs before shipment; travelling on an empty stomach means less faeces and reduced chances for travel sickness. (v) Accommodate the mammal to be transported properly in a cage, pole sling or stretcher. (vi) During transport, two attendants must be present. (vii) Avoid too high or too low temperatures, excessive draught, dry skin and dry atmosphere, as well as exposure to gasoline exhaust and tobacco smoke. (viii) Monitor room and body temperature; if necessary make adjustments (cooling, warming). For long distances use air-cargo service; avoid long ship, train or lorry transport.

Specific rules are listed in Container Notes 20 and 21 of the fifth edition of International Air Transport Association (IATA) Live Animal Regulations, effective from 1 June, 1976.* Container Note 20, applicable to seal, sea lion and walrus, includes Fig. 5-116 and lists the following major requirements regarding design and construction of transport containers: The container must consist of metal, strong welded wire mesh and wood. The cage interior must be smooth, all sides close-boarded up to a height of approximately 15 cm; the remaining portions of sides and door should be strong-welded wire mesh (close enough to prevent the mammal forcing its nose outside); a sliding or hinged door must be provided at one end. The container must be large enough to permit the mammal to move around. The floor

* Obtainable from: IATA, P.O. Box 160, 1218 Cointrin, Geneva, Switzerland. Live Animal Regulations are updated annually.

shall be smooth, the bottom leakproof. Container Note 21, applicable to dudong, manatee, dolphin, porpoise and whale, states that the container (Fig. 5-117) must be made of aluminium, canvas fibre-glass, foam rubber, plastic, PVC or wood. The waterproof box shall be made from wood with a plastic liner, or wood and fibre-glass, or moulded fibre-glass, or consist of a tubular aluminium frame with waterproof liner.

One individual is suspended in a stretcher of canvas or other suitable material supported on a foam-rubber pad. Slits shall be made in the stretcher to allow the flipper to protrude. The container must be long enough to afford 8 cm of clearance at head and tail, and be wide enough to assure 8 cm of clearance between the stretcher bars and body sides. Critical body areas, e.g. flippers, dorsal fin, fluke and head, shall be thoroughly covered with lanolin/petroleum-jelly-compound oint-

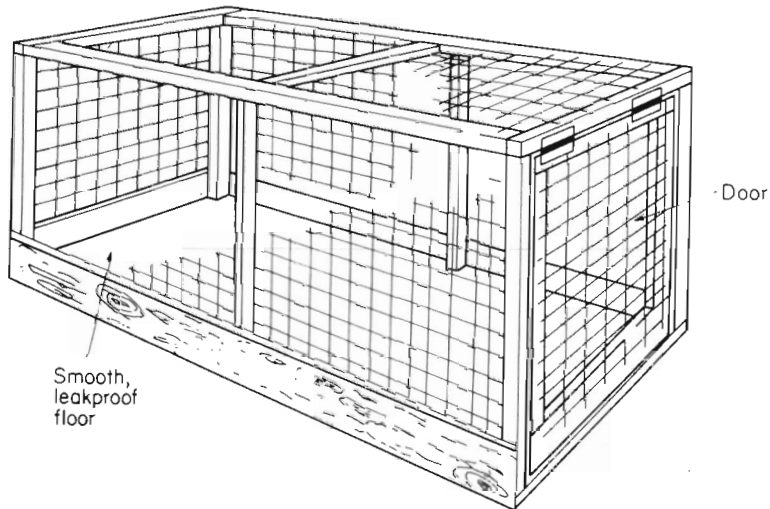

Fig. 5-116: Transport container for seal, sea lion and walrus. (Reproduced by permission of International Air Transport Association, fifth edition.)

ment, zinc oxide (or a combination of each). Padded restraining belts should be firmly but not forcibly fastened over the mammal to prevent violent movements. An attendant is required who shall have a mechanical hand sprayer available. No water should be sprayed over the head or near the blowhole (nostrils).

(d) Adjustments to Captivity

To the newly caught marine mammal, captivity conditions often amount to a major stress if not shock. Sudden separation from the natural social group, new surroundings, narrow space, different water quality, strange noises and, not least, the new kind of food offered—all this must be assumed to be a traumatic experience. According to WALKER (1975), newly caught *Delphinus delphis* usually arrive at the acclimation pool in an advanced state of shock. When released into the pool, a single individual often swims erratically with low-amplitude tail beats. Contact

with the enclosure walls typically causes the dolphin to sink to the bottom for periods of up to ca 30 secs before righting itself and returning to the surface. Fright-caused immobilization and temporary sinking has also been observed in several other dolphins; it may last for one to several hours or even longer. Normal swimming often begins only after 1 day.

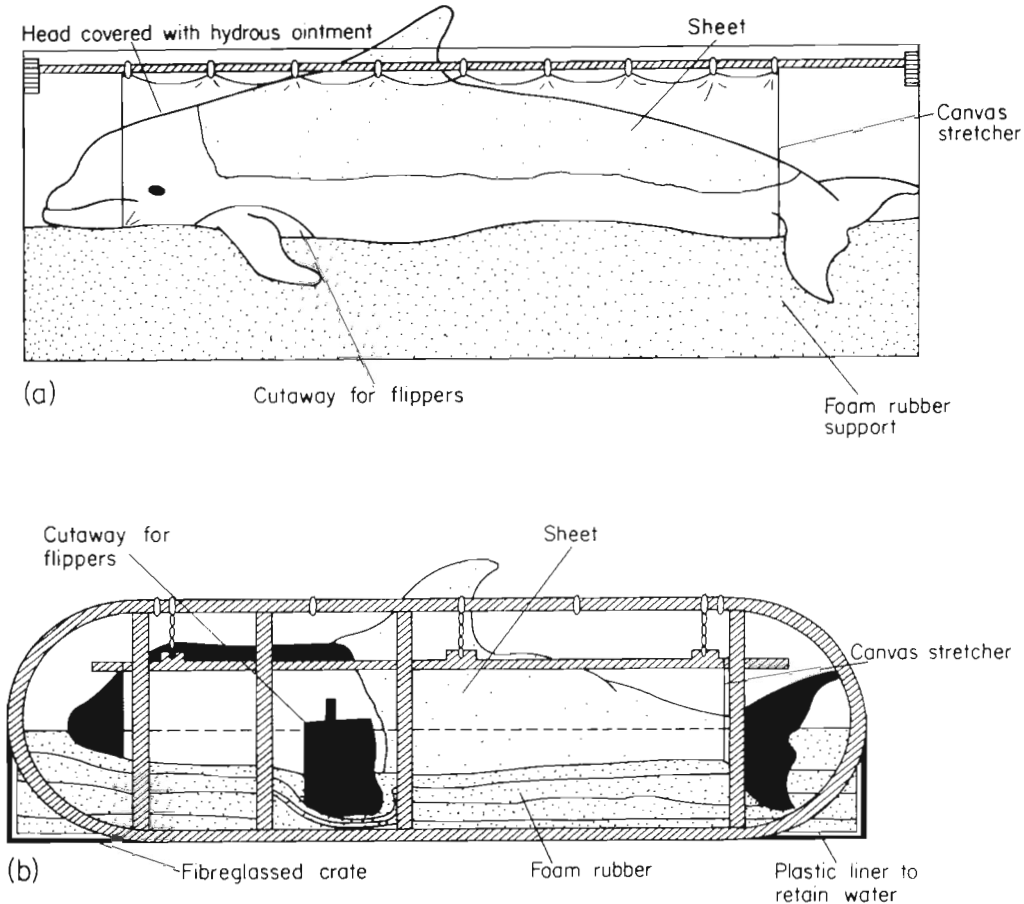

Fig. 5-117: Transport containers for (a) dolphin, (b) killer whale. (Modified; reproduced by permission of International Air Transport Association, fifth edition.)

The most critical adjustments must be made in the first few weeks. A newly caught pinniped or odontocete which survives 3 to 4 months without major complications is likely to complete its adjustments successfully, providing its essential environmental (p. 1063) and nutritional requirements (p. 1082) are met.

Although capable of admirable orientational performances under adequate conditions (Volume II: KINNE, 1975), newly caught, nervous odontocetes may crash into the tank wall and hurt or even kill themselves. While the resident population can help a newcomer to adjust, resident individuals may also exhibit territorial or dominant behaviour interfering with the adjustments necessary, especially with

feeding. In such a case, temporary—preferably partial (fence)—separation is desirable. Immediately after being introduced to the culture container, newly caught *Phocoena phocoena* often start to swim in very tight circles (ANDERSEN, 1976). They continuously produce echolocation clicks (Volume II, e.g. pp. 764–768) and only gradually widen their swimming circle until the whole container size is fully utilized. However, in the presence of resident conspecifics, ANDERSEN observed quicker adjustments in swimming behaviour (copying).

The capacity for adjusting to captivity conditions is usually minimal in very young or very old individuals. Maximum adjustments have been obtained with one- to several-year-old juveniles or young, sexually mature individuals. Fully adjusted mammals often develop a close relationship to their attendants—odontocetes more so than pinnipeds. Some delphinids, such as *Tursiops truncatus*, obviously appreciate affectionate, close contact and appear to enjoy being stroked. Since most marine mammals are used to life in social groupings, they should not be kept in complete solitude for any length of time. A lonely dolphin may become completely dependent upon human companionship.

In general, odontocetes have adjusted to captivity more readily than expected. Forms such as the bottle-nosed dolphin *Tursiops truncatus*, the pilot whale *Globicephala melaena* and the killer whale *Orcinus orca* surprised those who first caught, transported and accommodated them in small enclosures by their calmness and lack of aggressiveness (p. 1054). Even *O. orca* which is known to consume large daily rations of food (e.g. salmon, but also mammals such as seals, dolphins and whales) has behaved friendly towards man.

The personality of the attendant (keeper, trainer) and his ability to communicate with his captives is more important for successful cultivation in mammals than in any other group of marine organisms maintained in captivity:

‘His demeanor and his rapport with the animals will play an important part in the way they will respond to a captive environment. His individualized attention may mean the difference between success and failure’ (HUBBARD, 1968, p. 319).

Newly caught mammals sometimes begin to feed immediately, within a few hours, or after a few days. However, they may also stubbornly refuse to eat. ‘Shock’, the new surroundings and, especially, the unfamiliar food seem to be the major reasons for food refusal. Initiation of feeding requires patience. Most mammals should be allowed to starve for some days. If they still refuse to feed, the cultivator may resort to (i) offering natural, live food; (ii) group feeding, which may stimulate the fasting individual to participate; (iii) force feeding; (iv) hormonal induction of appetite. Force feeding is the most frequently used method; it receives more attention on p. 1087. Permanent feeding with live food is usually not possible because of supply and holding problems; several cultivators do not feed living food even if available because in small culture enclosures, hunting may lead to injuries and because live food organisms may introduce parasites and other disease agents. In addition, live-food feeding makes it difficult to control the daily food intake and decreases the motivation for trainer contact and learning.

The readiness with which food is accepted and the daily amount of food consumed (p. 1090) are important criteria for assessing adjustments to captivity. In addition,

faeces production may inform the attendant whether something is going wrong, especially in pinnipeds. According to HUBBARD (1968), pinniped stools are often loose and vary greatly in colour and texture—depending on the species concerned, the physiological state and the food consumed. HUBBARD describes the normal stool to be either loose, soft or formed (or a combination of these conditions) and tan to dark brown. Stools are considered abnormal if (i) watery and off-colour (grey, brown and yellow, or brown and green), (ii) containing free mucus, (iii) black and tarry. Green stools are often associated with an empty gut. According to A. HOLTSMANN (personal communication), captive *Phoca vitulina* often produce an orange-coloured stool during the mating season. The stool first floats on the water surface but soon dissolves. In all cases, faeces should be removed as soon as possible.

The Beginning of Odontocete Cultivation

The first white whales *Delphinapterus leucas* were caught in the St. Lawrence river in 1861, transported to New York and exhibited in the Barnum Museum. A 3-m, 318-kg *D. leucas* male became completely tame and survived for 2 years (LEE, 1878). A new area in odontocete research began when a few large public aquaria in Japan and USA started to cultivate and to experiment with captive representatives. In 1928, the Mito-Aquarium exhibited some 21 *Tursiops truncatus*; in 1933, the Yokohama Aquarium kept a pilot whale *Globicephala melaena* and the Hanshin-Park, 10 false killer whales *Pseudorca crassidens*. In 1937, 'Marineland' of Florida (USA) built a large culture tank and began, in cooperation with research institutions, to accumulate information on environmental and nutritive requirements of *T. truncatus* and related forms. The first pilot whale *Globicephala macro-rhyncha* was displayed in 1957 (BROWN, 1960); the first Northern Right whale dolphin *Lissodelphis borealis* in 1969 (J. SIMPSON, 1969, *in*: WALKER, 1975). In the following years, much was learned about the biology of odontocetes (e.g. NISHIWAKI, 1965; NORRIS, 1966a; ANDERSEN, 1969; RIDGWAY, 1972a) and about their elaborate mechanisms of orientation (Volume II: KINNE, 1975).

The first *Orcinus orca* captured alive and held in a public aquarium (Vancouver Aquarium, Vancouver, Canada) was a harpooned male named 'Moby Doll'; he survived only 3 months and died apparently due to complications developing from his harpoon wounds (NEWMAN and MCGEER, 1966). During the 3 months, two basic facts emerged which were later corroborated on other killer whales: (i) Moby Doll exhibited no aggressiveness towards his captors and keepers; (ii) he accepted the confined space offered without panicking. The second captive *O. orca*—a female apparently ill at the time of capture—survived only 3 days. The third *O. orca*, a large bull (6.6 m long, ca 3600 kg), was accidentally trapped behind fishermen's nets near Namu, British Columbia. Named after the capture site, 'Namu' became world famous (GRIFFIN, 1966; GRIFFIN and GOLDSBERRY, 1968). During the first 2 months of captivity, Namu showed little interest in food, although he was offered a large variety of potential prey. Only after 60 days did he begin to feed regularly and soon consumed a daily ration of 200 kg of fish; he greatly preferred salmon, but also accepted other fish native to the Puget Sound. Namu died after 1 year in captivity, presumably due to clostridial enterotoxaemia (*Clostridium perfringens*). The fourth captive *O. orca* was the female 'Shamu' (4.11 m; 1088 kg); she was

moved into the same culture enclosure with Namu and started eating salmon the day after capture (BURGESS, 1968; GRIFFIN and GOLDSBERRY, 1968).

Shamu first began to feed by taking scraps of food which Namu left (BURGESS, 1968), but by the fourth day she accepted fish from the trainer's hand. Seven weeks later, Shamu was flown to San Diego (USA) and exhibited in Sea World. Shamu's adjustments to captivity have been described in some detail by BURGESS (1968). We quote here from his report. During the first week, Shamu tended to float at the water surface and to emit loud blowhole sounds which could be heard over a distance of ca 100 m. These sounds gradually became less frequent. Sonar signals (Volume II: KINNE, 1975) were initially emitted from time to time but gradually disappeared almost completely. Since neurotic behaviour patterns (e.g. rolling in the water, ramming the head against the pool side and even biting the trainer) have been observed to develop in odontocetes kept in complete solitude, a white-sided dolphin *Lagenorhynchus obliquidens* was kept in Shamu's pool. This was a calculated risk because wild killer whales may eat dolphins. However, after a while, both adjusted increasingly to each other. Finally, mutual acceptance developed to a point where the dolphin achieved copulatory intromission with Shamu.

Longevity

Reliable estimates on average life spans of captive and free-living marine mammals are difficult to come by. Judged from the physiological data and mortality records available, aquatic mammal cultivation is not yet well developed (HARRISON and co-authors, 1968; HUBBARD, 1968; JONES, 1970; MAXWELL, 1972; DUDOK VAN HEEL, personal communication). Many cultivated pinnipeds and odontocetes have lived only for months or a few years—often presumably less than one third or one half of their natural life expectancies. Estimates of natural life spans vary from 16 to 18 years in antarctic phocids and to over 40 years in harp seals *Pagophilus groenlandicus* and ringed seals *Pusa hispida* (MCLAREN, 1958b). Some of the larger odontocetes such as the killer whale *Orcinus orca* are assumed to live for up to 50 or even 70 years.

Examples of maximum longevity records for captive pinnipeds are listed in Table 5-116, those for odontocetes in Table 5-117. Even in such commonly cultivated odontocetes as *Tursiops truncatus*, the average survival of captives used to range only between 8 and 10 months; with increased knowledge and experience, this span has gradually lengthened and at this writing may be close to 20 months. For less euryplastic dolphins such as *Stenella caeruleoalba* and *S. attenuatus*, the average survival is still low (weeks to a few months). The present average survival span of captive *Orcinus orca* may be close to 14 or 15 months. For records on longevity of captive pinnipeds and odontocetes consult also SCHEFFER and SLIPP (1944), BRIGHTWELL (1949), DARLING (1950), JARVIS and MORRIS (1960), MOHR (1966) and WALKER (1975).

Aggressiveness

Wild and captive pinnipeds may become quite aggressive if approached or cornered. Exceptions are some intensively trained forms such as the California

Table 5-116

Maximum longevity records of captive pinnipeds (Based on information compiled by JONES, 1970)

Family, genus, species	Time, facility
Otariidae	
<i>Arctocephalus australis</i> <i>australis</i> South American fur seal	3 years 1 month, New York Zoo (Bronx)
<i>A. australis galapagonensis</i> Galapagos fur seal	4 years 0 month, San Diego Zoo
<i>A. doriferus</i> Australian fur seal	16 years 0 month, Sydney Zoo
<i>A. pusillus</i> South African fur seal	20 years 1 month, London Zoo
<i>A. tropicalis gazella</i> Kerguelen fur seal	3 years 0 month, Antwerp Zoo
<i>A. philippii townsendi</i> Guadalupe fur seal	1 year 8 months, San Diego Zoo
<i>Callorhinus ursinus</i> Northern fur seal	9 years 2 months, San Diego Zoo
<i>Eumetopias jubatus</i> Steller sea lion	17 years 3 months, National Zoo, Washington
<i>Neophoca cinerea</i> Australian sea lion	4 years 10 months, Adelaide Zoo
<i>N. hookeri</i> New Zealand sea lion	2 years 10 months, London Zoo
<i>Otaria flavescens</i> South American sea lion	17 years 6 months, London Zoo
<i>Zalophus californianus</i> California sea lion	28 years 0 month, Tiergarten, Bremerhaven; 20 years 5 months, Philadelphia Zoo

Table 5-116—*Continued*

Family, genus, species	Time, facility
<i>Z. californianus wollebaeki</i> Galapagos sea lion	2 years 9 months, San Diego Zoo
Odobenidae	
<i>Odobenus rosmarus</i> <i>rosmarus</i> Atlantic walrus	15 years 0 month, Hagenbeck Tiergarten, Hamburg; 10 years 2 months, New York Aquarium
<i>O. rosmarus divergens</i> Pacific walrus	9 years 5 months, Marineland of the Pacific, Los Angeles
Phocidae	
<i>Crytophora cristata</i> Hooded seal	14 years 1/2 month, Tiergrotten, Bremerhaven
<i>Erignathus barbatus</i> Bearded seal	0 year 4 months, Berlin Zoo
<i>Halichoerus grypus</i> Grey seal	41 years 0 month, Skansen, Stockholm; 27 years 0 month, Edinburgh Zoo
<i>Histiophoca fasciata</i> Ribbon seal	0 year 3 months, Marineland Enoshima
<i>Hydrurga leptonyx</i> Leopard seal	2 years 4 months, Hagenbeck Tiergarten, Hamburg
<i>Lobodon carcinophagus</i> Crabeater seal	0 year 1 month, National Zoo, Washington
<i>Mirounga angustirostris</i> Northern elephant seal	9 years 6 months, St. Louis Zoo; 7 years 0 month, Berlin Zoo

Table 5-116—*Continued*

Family, genus, species	Time, facility
<i>M. leonina</i> Southern elephant seal	16 years 0 month, Hagenbeck Tiergarten, Hamburg 12 years 0 month, Stuttgart Zoo
<i>Monachus monachus</i> Mediterranean monk seal	8 years 0 month, Jardin des Plantes, Paris
<i>M. schauinslandi</i> Hawaiian monk seal	6 years 8 months, Waikiki Aquarium, Honolulu
<i>M. tropicalis</i> Caribbean monk seal	6 years 0 months, New York Aquarium
<i>Pagophilus groenlandicus</i> Harp seal	3 years 0 month, New York Aquarium
<i>Phoca largha</i> Kamchatkan harbour seal	4 years 4 months, New York Aquarium
<i>P. vitulina</i> Pacific harbour seal	34 years 0 month, Tacoma Aquarium 25 years 5 months, Seaside Aquarium; 21 years 3 months, National Zoo, Washington
<i>P. vitulina vitulina</i> Atlantic harbour seal	22 years 0 month, Berlin Zoo; 21 years 8 months, Helgoland Aquarium; 13 years 0 month, New York Aquarium
<i>Pusa hispida</i> Ringed seal	15 years 0 month, Skansen, Stockholm
<i>P. sibirica</i> Baikal seal	4 years 0 month, Game Farm, Alberta

Table 5-117

Maximum longevity records of captive odontocetes (Based on information compiled by JONES, 1970)

Family, genus, species	Time, facility
Monodontidae	
<i>Delphinapterus leucas</i> Beluga, white whale	5 years 5 months, New York Aquarium
<i>Monodon monoceros</i> Narwhal	0 year 1 month, Vancouver Aquarium
Platanistidae	
<i>Inia geoffrensis</i> Amazon dolphin	8 years 5 months, Fort Worth Aquarium
<i>Platanista indi</i> Susu, Ganges dolphin	0 year 5 months (moribund at catching), Steinhardt Aquarium, San Francisco; More than 5 years, Hirnanatomisches Institut, Ostermundigen*
Delphinidae	
<i>Lagenorhynchus obliquidens</i> Pacific white-sided dolphin	6 years 8 months, Steinhardt Aquarium, San Francisco
<i>Stenella dubia</i> Spotted dolphin	2 years 4 months, Marine Studios
<i>Tursiops gilli</i> Gill's bottle-nosed dolphin	13 years 4 months, Marineland, Enoshima
<i>T. truncatus</i> Bottle-nosed dolphin	20 years 0 month, Marine Studios
Phocoenidae	
<i>Neophocoena phocoenoides</i> Finless black porpoise	1 year 6 months, Toba Aquarium
<i>Phocoena phocoena</i> Harbour porpoise	3 years 2 months, Odense University†
Grampidae	
<i>Grampus griseus</i> Risso's dolphin	16 years 1 month, Marineland, Enoshima
Globicephalidae	
<i>Globicephala melaena</i> Pilot whale	10 years 6 months, Marineland of the Pacific, Los Angeles
<i>Orcinus orca</i> Killer whale	5 years 0 month, Sea World, San Diego

* G. PILLERI (personal communication).

† S. ANDERSEN (personal communication).

sea lion *Zalophus californianus*. Presumably, the aggressiveness of pinnipeds is related to the keen competition experienced on rookeries and its selective potential. Territoriality plays a major role during the rookery period. It is less important or absent in water, presumably due to the lower population density, as well as air breathing, hunting, fast movements and extended migrations.

In contrast, most wild and captive odontocetes maintain a friendly, non-aggressive attitude towards man under a variety of circumstances, including uncomfortable, dangerous or even lethal conditions. The calm, content and sociable mentality of odontocetes contrasts sharply with the pronounced aggressiveness of many terrestrial mammals, notably the primates, which would usually put up a fierce fight under comparable conditions. Lack of defence behaviour and of aggressiveness may have played a role during the phylogenetic development of cetacean ancestors from terrestrial to aquatic life.

Only under exceptional circumstances may odontocetes exhibit a mild form of aggression such as intensive water splashing, jaw clapping, rapid swimming towards an attendant (avoiding collision only at the very last moment), pushing the attendant aside, and pressing a diver temporarily against the floor or wall of the culture enclosure. No records of heavy injuries or casualties are known to the reviewer. However, wild, harpooned sperm whales *Physeter catodon*, although frequently allowing themselves to be slaughtered impassively, may fight using their toothed jaws for biting, their big head for ramming and their flukes for beating (CALDWELL and CALDWELL, 1966). Possibly under the influence of heavy pain, critically injured *P. catodon* have destroyed hunting boats. In captivity, the apparent reasons for occasional mild forms of aggressiveness include: hyper-nervousness, disease, unfriendliness of the attendant, prolonged individual confinement, territoriality or dominance behaviour, jealousy, and sexual competition.

Training

Training of captive marine mammals is based on positive reinforcement of desired behaviour, using food and affection (e.g. stroking, a pat on the head) as reward. Operant conditioning techniques (BRELAND and BRELAND, 1968) require the desired behaviour to be rewarded immediately and to punish failures in an adequate way, e.g. by the trainer turning his back or temporarily leaving the pool area. Gentle physical punishment or food withdrawal generally had no or much less success than positive reinforcement.

Initial training requires 4–8 weeks, complicated, 'polished' shows 8–12 months. For maximum performance, the tricks learned need continuous reinforcement and discipline is necessary to prevent performance decline. However, in some cases, gifted trainers have succeeded in conditioning performance details to such an extent that the trained dolphins immediately performed again after pausing for months or even years.

In principle, dolphin shows consist of behavioural elements also displayed in the unrestrained, natural environment. The major task of the trainer is to discover, emphasize and develop natural behavioural peculiarities of his captives and to relate them to an accoustical (whistle) or optical (hand sign) signal, thus making

them reproducible on command (e.g. REYNOLD, 1968; PEPPER and DEFRAN, 1975; ANDERSEN, 1976).

Typical show components include the following: (i) opening the show, e.g. by flying a flag (a dolphin brings down a small ball attached to a flag line); blowing a horn (squeezing of a ball attached to a trumpet), or ringing a bell; (ii) retrieval of rings, balls, dumb-bells, hats or other floating objects thrown into the pool by the trainer; (iii) balancing a hat or other objects on head or snout; (iv) throwing balls, e.g. into basket-ball nets, at ninepins or tourists; (v) pulling a rubber boat around the tank; (vi) jumping through a hoop, over hurdles or for a ball or fish positioned several metres above the water surface; (vii) tail walking, beaching, turning somersaults, shaking hands, tail waving while swimming head down in the water; (viii) swimming on the back; (ix) kicking balls with the fluke from the water surface high up into the audience. Trainers have also taught odontocetes such as *Tursiops truncatus* or *Orcinus orca* to perform in short skits.

Many experts consider the daily training and show routine desirable physical exercise which improves or maintains the mammals' fitness. Accustomed to hunting, often over large sea areas, the mammals would suffer from lack of exercise in their small culture enclosures unless moved about during show or feeding (e.g. AMUNDIN, 1974).

Experimentation

Captive marine mammals have facilitated a large variety of experiments, e.g. on diving, orientation, specific physiological functions and medical problems. Many experiments have been conducted on individuals restrained in various ways. However, a sea lion or a dolphin strapped to a board or otherwise tied to an experimental device is immediately under stress and may exhibit responses which differ significantly from those shown under unrestrained, more normal conditions (e.g. HARRISON and RIDGWAY, 1975). For ecologically meaningful experimentation, it is better to train the test individual to perform defined tasks in its tank or in its natural environment.

The first *in situ* experiments with trained *Phoca vitulina* (ELSNER, 1965) and *Tursiops truncatus* (BAILEY, 1965; NORRIS, 1965) were followed by a series of experiments which demonstrated the capability of pinnipeds (e.g. *Zalophus californianus*) and of odontocetes (e.g. *T. truncatus*) to cooperate in experiments conducted in the sea and to serve as messengers, rescuers and 'errand boys' for divers and aquanauts (e.g. RIDGWAY, 1966, 1972b; WOOD and RIDGWAY, 1967; IRVINE, 1970b; CONBOY, 1975; KOOYMAN, 1975; WARTZOK and co-authors, 1975).

Skin Shedding

In captivity, important annual dynamics such as skin shedding or moulting and migration (Volume II: KINNE, 1975) often receive relatively little attention. However, moult and migratory restlessness may significantly modify the mammal's behaviour and may require changes in the cultivation routine in order to assist the animals in adjusting to captivity. Recent reviews on structural aspects of the skin of marine mammals which include information on skin shedding have been presented by LING (1970, 1974), GREENWOOD and co-authors (1974) and HARRISON

and THURLEY (1974). According to LING, the main stimuli for the initiation and control of annual morphogenetic epidermis cycles presumably involve thyroid and adrenal hormones and the nutritional as well as reproductive status. On the basis of *in vitro* studies of pinniped epidermal cells, FELTZ and FAY (quoted in LING, 1974) have suggested that skin temperatures dictate aspects of moulting and related behaviour. Increased epidermal mitotic activity appears to require more rest of the individual concerned than usual as well as high tissue temperatures near 37° C.

Skin shedding tends to deeply affect behaviour, physiology and nutritional dynamics. While details of the shedding process and of its timing vary with the species involved (within the same species sometimes also with age or sex), most moulting pinnipeds tend to spend more time outside the water and to feed less or not at all. According to A. HOLTSMANN (personal communication), in the aquarium of the Biologische Anstalt Helgoland (FRG), long-term moult records reveal that 1- to 2-year-old *P. vitulina* moult earlier (beginning of August to the beginning of September) than older individuals (end of August to the end of September).

The postnatal shedding in pups of the grey seal *Halichoerus grypus* has been studied in detail by LING and BUTTON (1975). Hair shedding begins at both front and hind ends and expands towards the body centre, with the ventral regions lagging behind the dorsal so that the sides are moulted last. The rapid postnatal moult observed may be typical of ice-breeding seals. A general review of intra-uterine and postnatal moulting in pinnipeds suggested to LING and BUTTON that the first-formed pelage or pelages may be functionally useless during neonatal life, except when dry. The prenatal moult adjusts the seal pups better to aquatic life, since the adult pelage is believed to have a hydrodynamic rather than a thermo-regulatory function.

Odontocetes also exhibit high epithelial activities. In delphinids, the external skin layers are apparently continuously renewed. Significant environmental changes or sudden stress (e.g. change in water quality, chlorination, thermal stress) may greatly influence the shedding process. Newly caught odontocetes may respond to culture-water exposure with skin discoloration and skin peeling; in *Phocoena phocoena*, for example, the skin begins to peel off in pieces after hours or a few days (e.g. ANDERSEN, 1974a). Usually the peeling ceases after about 14 days.

The immediate causes of skin peeling have rarely been determined exactly. In some cases, salinity stress (p. 1075) appears to have been the major factor; in others, chlorine or high levels of dissolved organics may have been responsible. In a letter to the reviewer (1976), S. ANDERSEN writes 'Skin peeling in *Phocoena phocoena* is seen each time there is a shift in the chlorine level—upwards or downwards'. The skin seems to act as a sensitive indicator of water-quality changes.

Both pinnipeds and odontocetes have been observed to rub their skin against solid objects. In captivity, they may find sufficient opportunity for rubbing and scratching on the bottom and walls of their pools or resting areas. In smooth-surface pools, brushes or rocks have been fastened on pool bottom or walls. Some keepers provide their odontocetes with regular 'rub downs' after water drainage. Such skin treatment seems to be beneficial, if not essential, for proper skin care.

During summer, odontocetes may develop sunburn on their dorsal fin and back. This can be dangerous especially to individuals which tend to float over extended

periods of time at the surface. Sunburn may cause considerable skin damage. Following sunburn, huge skin particles begin to peel off. Sunburn can be prevented and treated by application of zinc oxide, Vaseline, Nandoral, vitamin K and other substances. According to S. ANDERSEN (personal communication), in surface-floating individuals, skin damage similar to that caused by sunburn, but less intensive, may also occur under indoor conditions due to prolonged dryness. In this case, regular automatic water sprinkling (e.g. every 15 mins) acts as effective countermeasure.

Antibiotics

Captive marine mammals are usually exposed to supranormal microbial densities. In addition, they are confronted with a variety of unfamiliar, dangerous human-inhabiting microbes—often strains which have acquired a considerable degree of immunity.

Where dangerous infections are observed or anticipated, marine mammals have been administered antibiotics, usually by intramuscular injection. Some practitioners administer antibiotics (e.g. oral doses of tetracyclines) to all newly captured pinnipeds and odontocetes. However, antibiotics should be used with care. Large doses of modern antibiotics applied lightheartedly may quickly contaminate the pool water and lead to the development of immune bacterial strains. Rigid suppression of bacteria may also enhance the development of pathogenic fungi. Neither the micro-organisms involved in marine mammal diseases (KINNE (in press)) nor the responses to antibiotics of the mammals tested have received detailed attention.

Several cultivators use Penicillin, often in combination with Streptomycin. While Penicillin appears to be one of the most reliable antibiotics, LILLY (1966) warns against the use of Streptomycin drugs since they may impair the vestibular apparatus. Other investigators have used 17.3 ml Tardomyocel (3.2 million I.U.) plus 16.7 ml Voren for each 400 kg of mammal body weight, or a 20% solution of Leucomycin: 22 ml on each of 3 consecutive days (GEWALT, 1969, 1970).

Major infectious diseases observed in cultivated marine mammals include influenza, sinusitis and erysipelas. LILLY (1966) has treated erysipelas in porpoises with a mixture of Combiotic, 5 cm³ (or Penstrep, 5 cm³), Bejectol, 5 cm³, plus kaolin-bismuth-pectin, 5 or 6 oz, introduced into the stomach of an adult *Tursiops truncatus*; the k-b-p was included because one of the symptoms of erysipelas is an inflamed stomach, which in itself can be fatal. However, in acute cases, such treatment may not be effective and sick individuals may often die within a few hours after the onset of symptoms. DUDOK VAN HEEL (1972) used one 500-mg tablet per dolphin of Lederkyn (= Madribon = sulphametoxypridanine); according to veterinary experience, this stops erysipelas and exerts long-lasting (2 to 4 days) effects.

According to requirements issued by the Florida Department of Natural Resources (USA), all newly caught marine mammals must now be vaccinated against erysipelas within 1 week of starting to feed in captivity. Commercially available swine erysipelas vaccine is satisfactory for this purpose. For further details on antibiotic treatment see also previous sections of this chapter and LAUCKNER (in press).

(e) Environmental Requirements

Exhibition, the primary concern of most marine mammal facilities, has often restricted research on environmental requirements to marginal activities considered permissible without interfering with the primary goal—attracting the public in order to make money. Statistically sound analyses of responses to environmental factors—similar to those conducted on invertebrates and fishes (Volume I)—cannot be performed on marine mammals: there are neither sufficient numbers of individuals available for such purpose, nor would it be acceptable to expose marine mammals to LD₅₀ tests.

Most of the information available on environmental requirements of captive pinnipeds and odontocetes refers to minimal conditions assumed to be essential for long-term exhibition. The mammals' true ecological requirements have largely remained in the dark. For evaluating environmental requirements, the ecologist must insist on sufficiently large culture enclosures with controllable conditions, on adequately patterned surroundings and on close-to-natural social groupings. Many ecological problems related to environmental requirements can be dealt with in fence- or net-isolated parts of natural habitats. Since many wild mammals adjust well to human presence, *in situ* studies, e.g. in rookeries, odontocete breeding quarters or along established migration routes, can reveal insights which cannot be gained under captivity conditions.

Culture Enclosure: Minimum Standards

Minimum culture-enclosure sizes for captive marine mammals, commensurate with acceptable exhibition goals and managing efforts and in line with law-enforced rules, are considered in the following paragraphs. Each mammal-keeping facility should have at least 2 well-trained keepers and one qualified consultant veterinarian. A team of zoologists, veterinarians and pathologists would be ideal.

The culture-enclosure sizes discussed below refer to the survival of species which adjust rather well to captivity. For sustaining less euryplastic representatives—such as some of the open-sea forms—and for successful breeding of captive marine mammals, larger culture enclosures, better water quality and larger social groups are necessary.

Marine mammals must not be kept in individual isolation. In exceptional cases, the keeping of 2 individuals per enclosure seems to be permissible, but normally the minimum population size should be 3—preferably 1 male and 2 females. The following minimum standards refer to such a trio population. Where larger populations are sustained, the minimum standards must be enlarged accordingly.

Captive pinnipeds require culture enclosures with a pool and a land area which allow easy movement from water to land and vice versa, and with one or more pupping rooms. The latter should have a wooden floor or a heatable concrete floor. An additional enclosure, similar to a pupping room, is desirable for temporary isolation and medical treatment.

The minimum pool length should be 5 to 6 times the adult body length (ABL) for fast swimming pinnipeds; and minimum pool width and depth must be equivalent to 1 ABL. For slow swimmers, minimum pool length may be reduced to 3

or 4 times ABL. Most pools are oval, rectangular or irregular in shape. Oval and round pools facilitate long-term, uninterrupted swimming, as well as efficient waste removal (vortex formation) and water turnover.

For temporary maintenance, e.g. of newly caught pinnipeds prior to long-term shipment, a variety of cages have been used (HUBBARD, 1968). In coastal areas, floating live pens have been employed with a small resting area. In general, most operators try to keep temporary and permanent pools as small as possible in order to reduce the expenses and to allow maximum control over animals and water quality.

Pinnipeds are usually kept on bare cement ground, but for resting quarters wooden grids may be desirable. Some pinnipeds have been claimed to require, or do better on, sandy ground, e.g. the elephant seal *Mirounga angustirostris* (POURNELLE, 1962).

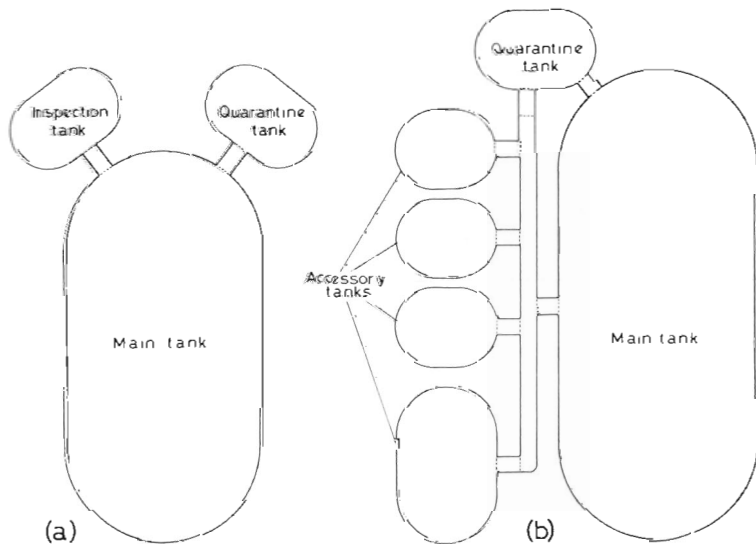

Fig. 5-118: Culture enclosure for captive odontocetes. (a) Minimum system; (b) versatile system with main tank, quarantine tank and four accessory tanks. (Original.)

However, the use of sand introduces several problems including fly control, muddy ground and muddy pool water (HUBBARD, 1968). A culture enclosure for harbour seals *Phoca vitulina* has been described by JOHNSON (1969).

Several otariids and odobenids exhibit surprising climbing abilities. According to HUBBARD (1968), they can raise themselves over any object on which they can stretch and place their foreflippers or even their chin. In two cases, sea lions have been observed to climb over 1.8-m high fences (CRANDALL, 1964). However, in general, walls of 1.20 m and fences of 1.80 m which do not provide footholds can be considered to represent adequate culture-enclosure walls. As is well known, phocids moving about on land rely primarily on their foreflippers, while otariids propel themselves forward employing fore and hind flippers and caterpillar-like body movements. Although less well adapted to land life, phocids such as the harbour seal *Phoca vitulina* and the grey seal *Halichoerus grypus* can jump forward with so much

vigour that they lift their whole body temporarily above the ground (BACKHOUSE, 1961).

Captive odontocetes require more than one tank. There should be at least 1 main tank, 1 inspection tank and 1 quarantine tank for medical treatment (Fig. 5-118a). Additional tanks increase the usefulness and versatility of the system (Fig. 5-118b). All tanks should have their own water recirculation and water-treatment systems; they must be connected by canals. Ideally the tanks should be completely separable from each other by watertight bulkheads. However, grated doors are also acceptable. Where necessary, the tank water must be thermally controlled.

Minimum main-tank dimensions depend on the odontocetes cultivated. Fast swimmers and pelagic forms require more space than docile ones or than estuarine

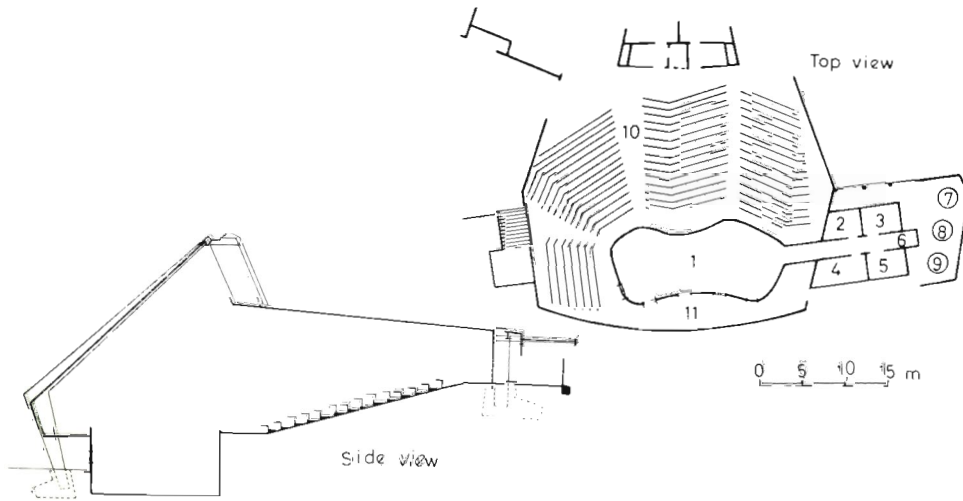

Fig. 5-119: Duisburg Dolphinarium (FRG). Water recirculation and filtration separately or in combination for main tank (1), 4 accessory tanks (2-5), and treatment tank (6); 7-9: gravel filter; 10: 750 seats; 11: underwater view ports. Total water volume: 725 m³; turnover rate: ca 2 hrs. (After GEWALT, 1969; modified; reproduced by permission of Akademische Verlagsgesellschaft Geest & Portig K.G.)

and river dolphins. Minimum dimensions are presently being considered as: length = 2 to 3 × adult body length (ABL), width (or diameter of round pool) = 2 × ABL, depth = 0.5 to 1 × ABL (minimum = 1.6 m for dolphins, 3 m for small whales). As a rule of thumb, 100 m³ of water should be allowed for 2 *Phocoena phocoena*, or 1 *Tursiops truncatus*, or 1/10 of an *Orcinus orca* (ANDERSEN, 1973).

Open-water pens and fenced-in sea areas have been used with considerable success (e.g. HOEY and THORNTON, 1971). However, environmental control is restricted or impossible under such conditions. Hence, most cultivators have kept their animals in land-based, closed or open sea-water systems. In these systems, the culture enclosures should have smooth, easy-to-clean surfaces (e.g. epoxy finish, tiles) resistant to detergents, disinfectants and salt, and have bottom drains and surface-water skimmers for water exchange and cleaning. In general, a closed sea-water system

(Chapter 2, p. 42) with recirculated, treated water affords the best control over water quality. Open systems (p. 39) can be used only where unpolluted sea water is readily available. Culture-water treatment usually includes filtration, e.g. sand-gravel filters (p. 114), rapid sand filters (p. 119), disposable cartridge filters (p. 121), and disinfection (e.g. chlorination, p. 1077). The degree of culture-water treatment depends on the animal load (p. 166) carried by the system. The carrying capacity of marine mammal facilities has, apparently, never been studied critically. Although a somewhat different situation prevails in mammals than in invertebrates and fishes, for lack of better information the reader is referred to Chapter 2, pp. 167–179.

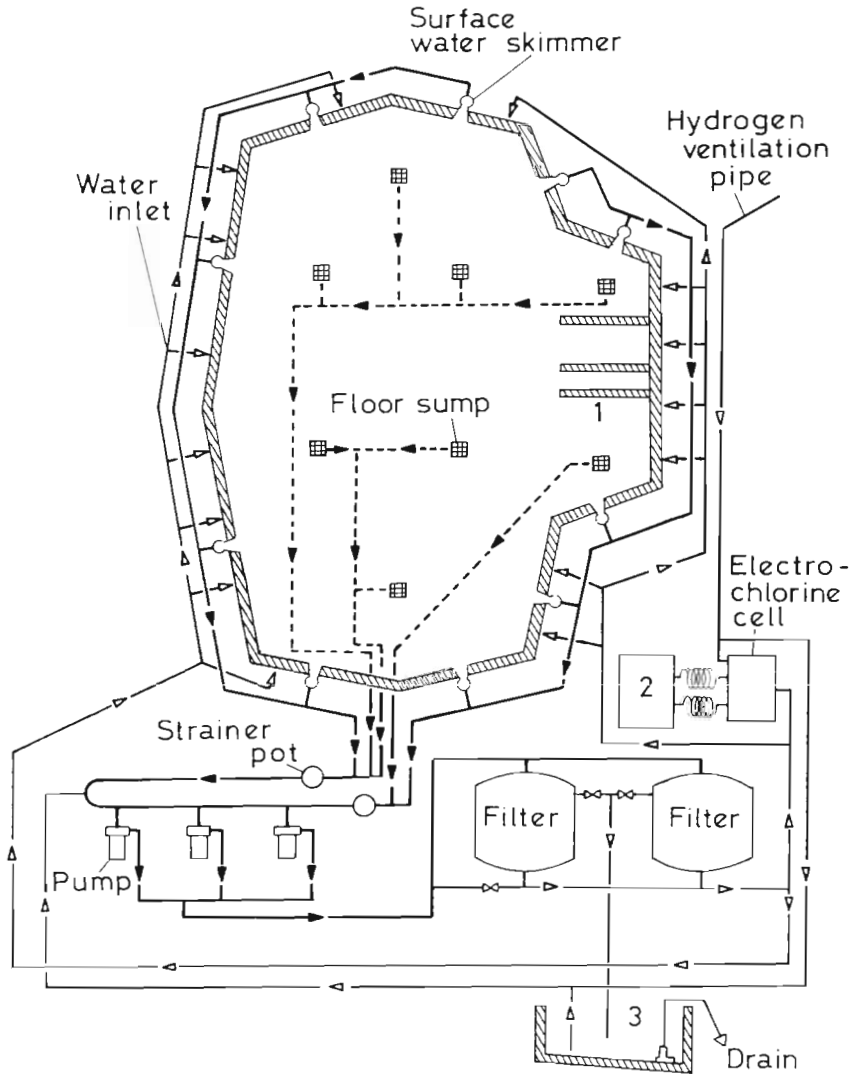

Fig. 5-120: Brighton Dolphinarium (England). Water-recirculation diagram. 1: Holding pens; 2: electricity rectifier; 3: filter backwash and water reclamation. (After WALLIS, 1973; modified; reproduced by permission of Dolphinarium Harderwijk.)

For a dolphin pool, RIDGWAY (1972b) considers the following formula to express the minimum turnover rate (ca 24 hrs) required:

$$\text{GPM} = 4 \times \frac{\text{TC}}{1000} + \left(0.5 + \frac{\text{TC}}{1000} \times \frac{\text{AW}}{100} \right)$$

where GPM = gallons min^{-1} (1 U.S. gallon = 3.785 l); TC = tank capacity in gallons; AW = animal weight in kg.

Culture Enclosure: Examples of Exhibits

We cannot review here in detail the numerous different architectural and constructional aspects of marine mammal exhibits. Designs of aquatic mammal exhibits, dolphinariums and oceanaria have been described, for example, by COATES (1961), CURTIS (1962b), GRAY (1962), KLÖS (1962, 1974), OLSEN (1962), GEWALT (1965, 1969), JONCH (1965), DUDOK VAN HEEL (1970), GEWALT and HABERKORN

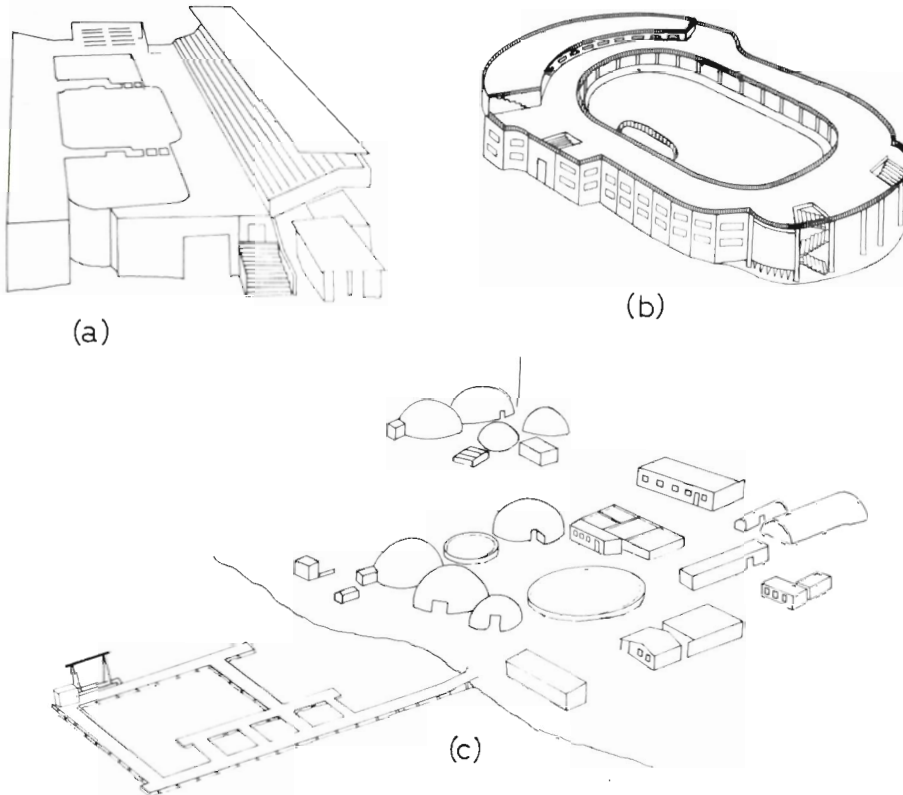

Fig. 5-121: Examples of major marine mammal facilities. (a) Kamogawa Sea World (Japan), with 3 lattice-door-separated divisions; overall tank dimensions: ca 55 × 15 × 5 m deep; (b) Marineland Enoshima (Japan), with the main tank measuring 45 × 25 × 6 m deep; 3 to 4 underwater observation levels; open system; (c) Marine Bioscience Facility, Mugu Lagoon (USA). (All figures based on photographs.)

(1970), VAN DEN BERGH (1970), ANONYMOUS (1973b), HEYDORN (1974) and MANTON (1974).

Examples of small dolphin exhibits are the Duisburg Dolphinarium (Fig. 5-119) and the Brighton Dolphinarium (Fig. 5-120). The latter has a total capacity of 850 m³ and consists of a main pool, ca 30 m long, 10 m wide and 3 m deep and 3 accessory pens (13 × 4 × 3 m deep). Tanks and water-treatment systems have been designed to sustain 6 to 8 dolphins (WALLIS, 1973). From the main pool, the water drains

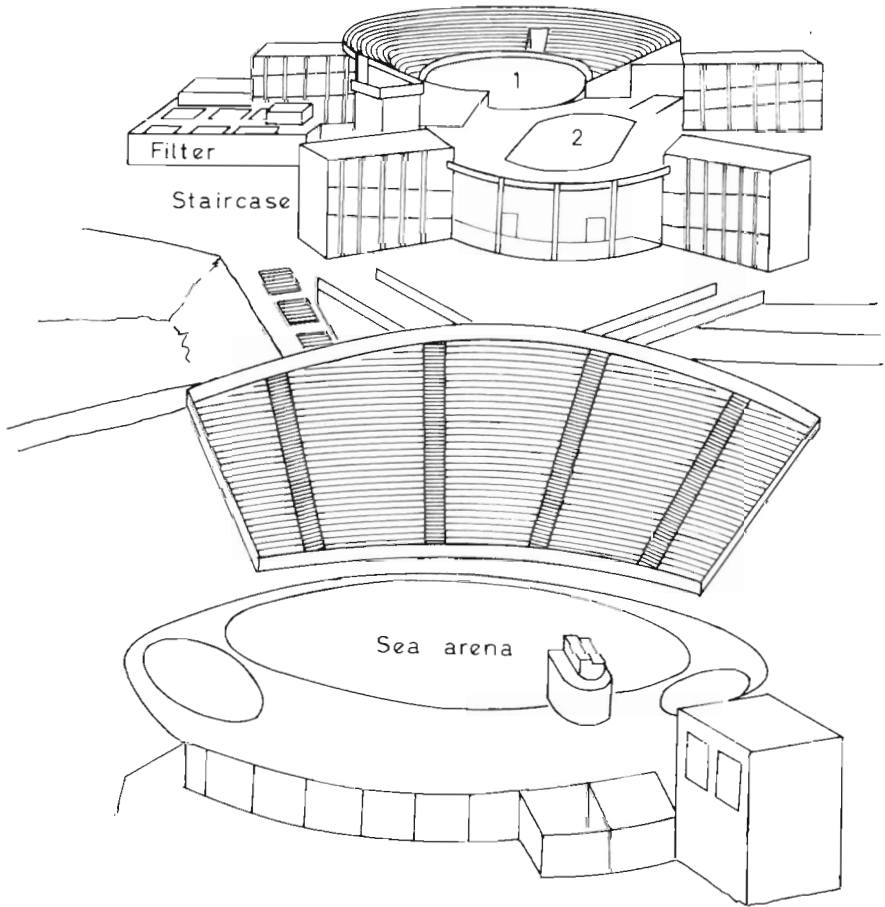

Fig. 5-122: Marineland of the Pacific (USA). General view. 1: Whale stadium; 2: fishbowl. (Based on a photograph.)

through 8 square bottom sumps (0.5 m) and 10 hydraulically balanced surface-water skimmers (each removing 600 l hr⁻¹ and skimming slick from up to 56 m² of water surface). The water is then passed through two 2.3-m-diameter sand filters achieving a flow of 371 m³ hr⁻¹ and a turnover rate of 2 hrs 15 mins. Large strainer pots retain fish scales and other debris, and thus protect the pumps. The purified water returns to the main tank via 17 inlets. All filters are backwashed daily, the backwash water being discharged into a 10-m³ sump; after settling overnight, the supernatant water is returned to the pool via the filters.

Examples of large marine mammal facilities, devoted primarily to the cultivation of odontocetes, are the Japanese Kamogawa Sea World (Fig. 5-121a) and Marineland Enoshima (Fig. 5-121b), and the North American Marine Bioscience Facility, Mugu Lagoon (Fig. 5-121c), Marineland of the Pacific (Fig. 5-122) and Miami Seaquarium.

Marineland Enoshima sustains in its main tank up to 16 *Tursiops truncatus gilli*, 3 *Grampus griseus* and 2 *Pseudorca crassidens* (verbal communication of local personnel). Although water visibility of this flow-through system is often regrettably poor and several ducks inhabit the tank's surface, Marineland Enoshima, proudly presents a list of more than 60 successful dolphin births (mostly *T. truncatus*), and has obtained life spans of captive dolphins exceeding 16 years. There are no accessory tanks; newly captured odontocetes are separated in a section of the main tank by a net curtain.

Marineland of the Pacific, located near Los Angeles, provides for its 20 seals and sea lions ca 200 m² of haul-out area and a 129 m² pool with a capacity of 160,000 l (PRESCOTT and CORNELL, 1975). During breeding, only 1 bull is allotted for each group. The whale stadium consists of a circular tank (24.4 m diameter; 6.7 m maximum depth; 2.4 million l). When the reviewer last visited Marineland in 1971, the whale-stadium tank contained 3 *Orcinus orca*. The turnover rate was ca. 3 hrs, and ca 13,000 l min⁻¹ passed through the sand filters at 90 l min⁻¹ m⁻² of filter surface (PRESCOTT, personal communication). The total sand-filter area covered 167 m². Each day, about 227,000 l of the culture water was replaced by fresh sea water from the Pacific Ocean. Through 3 levels of windowed corridors, the clear water offered a unique view.

Miami Seaquarium has a 1.8 million-l main tank with sides of curved sheets of structural steel (0.95 cm thick), reinforced with vertical girdles and horizontal bracing (GRAY, 1962). The 150 polished plate-glass viewing ports are arranged on two levels. They are set in stainless-steel frames (2 glass plates per view port, separated by a space containing desiccants to absorb condensed moisture). Using a series of angled jets, the filtered sea water enters the tank through the floor, rising in circular movements and leaving through a large screened grating in the tank-floor centre as well as through a surface drain which carries off scum and floating debris.

Culture-water Quality

In addition to culture-enclosure size (p. 1063) and nutrition (p. 1082), culture-water quality (Chapter 2) constitutes the most important prerequisite for successful long-term cultivation of marine mammals. Essential culture-water criteria include: (i) organic wastes (urine, faeces, food remains), (ii) pathogenic micro-organisms (viruses, bacteria, fungi), (iii) parasites, and (iv) chemical pollutants (Chapter 7).

Organic wastes pollute the culture water often beyond the water-treatment capacity available. Many dolphinaria, especially in Europe, have water-treatment systems copied from those installed in public swimming pools. This is totally inadequate. As ANDERSEN (1973) has pointed out, swimming pools are used only during the day and even in this period pauses occur during which the water can regenerate; the swimmers are clean, they do not normally defecate and urinate in

the water, and do not spoil the water with leftovers of their meals. Finally, the chlorine concentration in swimming pools can be maintained at higher levels than in dolphinaria, and the turnover rate can be kept as low as 4 to 8 hrs. In contrast, dolphins produce large amounts of organic waste materials. According to RIDGWAY (1972b, p. 681), a 136-kg dolphin receiving a daily ration of 6.6 kg fish produces more than 4 l of urine and about 1.4 kg of faeces day⁻¹. Hence, water treatment systems for dolphin pools require special designing and turnover rates should be between 1 and 2 hrs.

Pathogenic micro-organisms attain much higher population densities in the water of most culture facilities than under natural conditions. Especially open-ocean mammals normally encounter very low concentrations of micro-organisms both in water and air. In captivity, they are confronted with numerous unfamiliar pathogens. Stress, due to capture, transport and captivity conditions, lack of natural

Table 5-118

Principal methods for reconditioning culture-water treatment in closed sea-water systems (for details consult Chapter 2, pp. 100–166) (Original)

Type of treatment	Main functions	Main procedures
Mechanical	Removal of excessive suspended particulate and colloidal substances	Sedimentation (flocculation), centrifugation, filtration
Biological	Maintenance of life-endangering substances (e.g. nitrogenous wastes) at acceptable concentrations	Microbial water treatment, algal water treatment
Physico-chemical	Removal of excess dissolved organic substances	Activated carbon adsorption, foam separation, aeration, oxygenation, ozonation, ultra-violet irradiation

resistance and the fact that many human-inhabiting microbes have developed high tolerances to body-own anti-microbial mechanisms as well as to antibiotic treatment, renders captive mammals very vulnerable to microbial attack.

Parasites, often released with clouds of faecal matter (which cannot be removed as quickly as would be desirable), may find new hosts easily under the crowded conditions usually prevailing in culture enclosures. However, experimental proof for this assumption is not available. Deep freezing of the food (fishes, squid, etc.) kills practically all parasites which could otherwise enter the host *per os* (for details consult LAUCKNER (in press)).

Chemical pollutants of the culture water have been considered in Chapter 7. Toxic chemicals and materials used for disinfection such as chlorine may cause damage if allowed to surpass critical levels. While useful for many purposes, chlorination (p. 1077) interferes with biological water treatment (p. 122), i.e. waste-product decomposition due to microbial (p. 123) and/or algal (p. 129) activities. As is well known, heavy metals and insecticides may be detrimental to marine mammals.

Since delphinids possess little, if any, plasma cholinesterase, organophosphate-insecticides must be banned from the vicinity of culture tanks (RIDGWAY, 1972b).

Water-treatment standards

Mainly with an eye on marine invertebrates and fishes, water-quality management and culture technology have been reviewed in Chapter 2. For details on culture-water treatment, reconditioning treatment and post-treatment, consult pp. 100-166. In closed sea-water systems, 3 types of reconditioning treatment can be distinguished: mechanical, biological and physico-chemical (Table 5-118). The ultimate choice depends on factors such as animal requirements, animal load, local

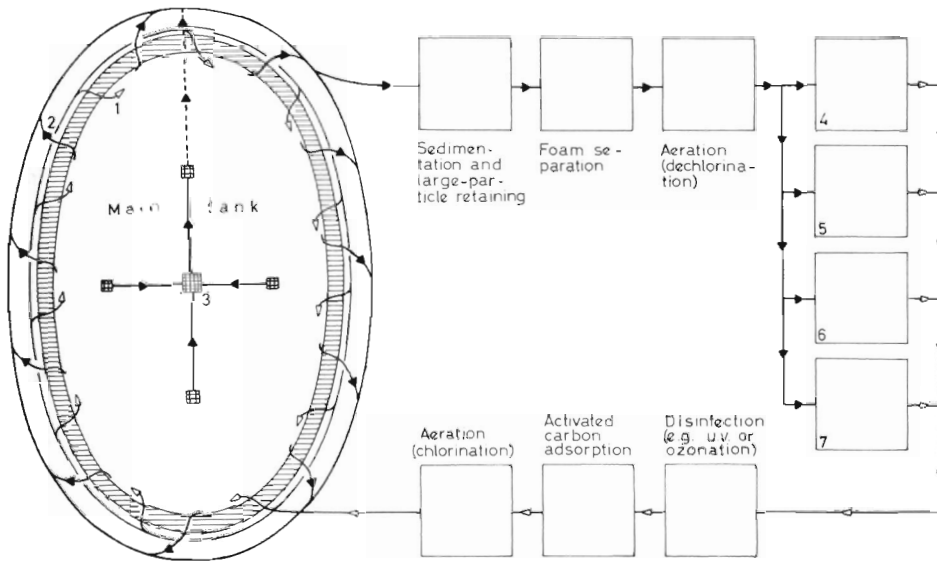

Fig. 5-123: Principal water-treatment plan for a main dolphin tank. Accessory tanks not shown. 1: Tangential water-entry jets at mid-depth level force the tank water to circulate; 2: surface-level skimmers remove floating debris; 3: main and accessory bottom drains; 4-7: filters. (Original.)

conditions, cultivation goal and financial means. Water-treatment standards for marine mammals necessitate additional considerations. Many experts have pointed out that, for marine mammals, culture-water quality must meet, or be above, the requirements established by the U.S. Public Health Service for bathing areas (maximum tolerable average coliform concentration: 10 MPN ml⁻¹). For holo-aquatic forms such as odontocetes—especially the open-ocean dwellers among them—culture-water quality should approach organic loads and microbial densities characteristic of unpolluted open-sea areas.

A basic plan for culture-water treatment in a marine mammal facility is illustrated in Fig. 5-123. This figure shows only the main tank; all accessory tanks must have their own water recirculation and be linked to the general water-treatment system. The system components should be adjusted in size and capacity to allow for turnover rates (p. 118) of about 1 to 2 hrs. Sand-gravel filters are very suitable, but

require much space. ANDERSEN (1973) has calculated that a dolphin culture system of 300 m³ with a filtration rate of 5 m³ m⁻² hr⁻¹ and a turnover rate of 2 hrs necessitates a filter surface of 30 m². A rapid sand filter (p. 119) needs much less space and attains a filtration rate of 50 m³ m⁻² hr⁻¹. In several cases, rapid sand filters have been used in combination with culture-water chlorination. Since rapid sand filters are less suitable for maintaining filter-bed micro-organisms than are sand-gravel filters, and since chlorination interferes with the establishment of microbial decomposers, the level of life-endangering organic substances may become critical in such culture systems. Foam separation, ozonation and activated-carbon absorption should be employed where organic overloads pose a definite threat. For further details consult Chapter 2.

Flocculation, i.e. the forming of large precipitates by chemical means, increases the effectiveness of sedimentation. It is applied before the culture water enters the sedimentation tank, in special settlers (Fig. 2-59, p. 113) or (less desirable) directly in the tank water. Flocculating agents include aluminium sulphate, sodium aluminate and ferrous chloride. The flocculate precipitates formed, e.g. aluminium hydroxide, collect negatively charged small suspended particles and thus grow and sediment. At Duisburg Zoo (FRG), aluminium flocculants are used in amounts of 1 g m⁻³ hr⁻¹ (GEWALT, 1969).

Effective water circulation in culture enclosures, especially of odontocetes, is of paramount importance. In large tanks, efficient water recirculation and high turnover rates of 1 or 2 hrs can be achieved only if the culture-tank water rotates fast and efficiently, i.e. if there are no 'dead corners' or 'dead water bodies'. Efficient water recirculation depends on tank contour, bottom shape, placement and direction of water-injection sites and placement of bottom and surface drains. Round or oval tanks facilitate vortex formation and are ideal for efficient water exchange. Forceful tangential water injection maintains the whole water volume in a rotating movement. Bottom and surface drains must allow even large-sized faecal matter and debris to drain immediately.

Major water-quality criteria to be monitored include: temperature (Volume I, Chapter 3), salinity (Volume I, Chapter 4), BOD (this volume, p. 108), NH₃-N (p. 81), bacterial counts (present section; p. 301; Volumes I, II, IV), pH and, where applicable, free and combined chlorine (p. 1078). pH values in the culture water should remain between 7.6 and 8.0 (7.4–8.3).

Temperature

The temperature requirements of pinnipeds and odontocetes are insufficiently known. The few definite values presented in the literature are based on estimations or rough guesses rather than on critical experimentation. However, it is obvious on the basis of zoogeography, morphology, physiology and behaviour that different species may have very different thermal requirements. The California sea lion *Zalophus californianus*, for example, is adjusted to life at much higher ambient temperatures than the walrus *Odobenus rosmarus*, and the bottle-nosed dolphin *Tursiops truncatus* requires much higher temperatures than the beluga *Delphinapterus leucas*. Many marine mammal facilities have paid insufficient attention to such thermal-requirement differences. In fact, some have kept arctic and tropical forms in one and the same enclosure.

In general, the tolerance to extreme ambient thermal conditions and the capacity for thermoregulation appear to attain life-cycle minima in newly born individuals. This fact is of great importance in cultivation. In pinnipeds, it calls for adequate temperature control in the pupping area (e.g. heated or cooled floors, controlled air temperature), and in odontocetes for tank-water temperature control.

Seal pups have been reported to shiver readily if exposed to subnormal temperatures and to suffer if exposed to prolonged sun radiation. Pups of *Mirounga leonina*, for example, tend to become restless in warm sun, and LING and THOMAS (1967) have seen cows throw sand over themselves until they were partially covered. Apparently, the capacity for thermoregulation improves quickly with age. Heat preservation during cold spells depends on subcutaneous body-fat formation. On the other hand, too thick peripheral fat layers, due to overfeeding and/or lack of exercise, may create problems of metabolic heat dissipation during warm days (e.g. HARRISON and TOMLINSON, 1963, p. 131; see also HARRISON and KOOYMAN, 1968).

Pinnipeds, such as the California sea lion *Zalophus californianus*, have been shown to be able to live for years without a pool, providing they are protected from overheating (HUBBARD, 1968). Critically high temperatures, e.g. during direct sun exposure in summer, must be reduced immediately—for example by spraying cold water over the mammals or by providing air conditioning. However, thermal shock or excessive draught should be avoided. On very hot days, pinnipeds have been observed to keep their mouths open for extended periods of time and to pant; concomitant flipper and head movements may aid in body-heat dissipation. While skin and fat layer represent only moderately flexible insulators, body appendages—particularly the hind flippers—are claimed to function as highly flexible heat dissipators (MCGINNES, 1975). However, R. J. HARRISON in a letter to the reviewer (1976) does not agree with this. Unpublished anatomical studies suggest to him that there is little reason to assume the existence of an efficient heat-loss mechanism in the hind flippers. He is inclined to look for some other function of flipper movement—may be simply fanning and air circulation—or even cooling of the adjacent sand (substratum).

When measured over extended periods of time, deep body temperatures of pinnipeds have often been shown to vary considerably (SCHEFFER, 1958). Depending on ambient temperatures and locomotory activities, they may fall or rise quite rapidly over a range of up to 8 or even 10 C° (MCGINNES, 1968). *Zalophus californianus* exposed to air temperatures ranging from 10° to 36° C were unable to achieve thermal equilibrium at 30° or 36° C, their rectal temperature attaining 40° C after 140-min exposure (WHITTOU and co-authors, 1970, 1972); approximately 15 to 22% of the body heat was lost via evaporation of moisture from the skin, while respiratory evaporative cooling amounted to only 1 to 3% (MATSUURA and WHITTOU, 1972). Heat flow to a wet sand substratum tends to be greater than to dry sand (WHITTOU and co-authors, 1975). In young *Phoca vitulina*, SCHOLANDER and co-authors (1942) recorded a rapid decrease in body temperature of 2.5° C during experimental dives. Some measurements of pinniped body temperatures are listed in Table 5-119. In 1- to 5-month-old *Odobenus rosmarus*, RAY and FAY (1968) estimated the lower limit of thermoneutrality (still air, shade) to be ca. 5° C; in adults it is probably lower than -20° C. The estimated upper limit of thermoneutrality is ca 18° C both for calves and adults. Above 18° C, elevated temperatures

Table 5-119
Pinniped body temperatures (Compiled from the sources indicated)

Species	Body temperature	Remarks	Author
<i>Callorhinus ursinus</i>	37.7° C	(mean deep body temp.)	BARTHOLOMEW and WILKE (1956)
	38.2° C	(mean rectal temp.)	
	35.0° C	(mean body temp., 10 cm depth)	Adults resting in air at 8° to 9° C during day; 2- to 6-week-old pups Adults measured during day
<i>M. leonina</i>	33.8° C	(mean deep body temp.)	Adults measured at night
	36.3° C	(32.2°-38.4° C)	Adult measured during day
<i>Leptonychotes weddelli</i>	36.7° C	(mean deep body temp.)	Adults measured during day
	(32.4°-37.8° C)		
<i>Eumetopias jubata</i>	38.5° C		Adults measured during day
<i>Erignathus barbatus</i>	Ca. 37° C		SPECTOR, quoted in HARRISON and KOOYMAN (1968)
	(36.8°-37.3° C)		SPECTOR, quoted in HARRISON and KOOYMAN (1968)
<i>Odobenus rosmarus</i>	36.1° C		SPECTOR, quoted in HARRISON and KOOYMAN (1968)
			RAY and FAY (1968)
<i>O. rosmarus</i>	36.6° C	(rectal temp. in adults)	
	34° to 39° C	(rectal temp. in pups)	
	37°-38° C	(higher in pups)	Adults measured during day
<i>Phoca vitulina</i>			Adults measured during day
<i>Phoca vitulina</i>	39.5° C	(rectal temp.)	Adults on hot, windless days

were recorded in skin, flippers and body, as well as restlessness, cutaneous hyperaemia and fanning. Mechanisms of thermoregulation in pinnipeds and odontocetes have received attention from SCHOLANDER and co-authors (1950), TOMILIN (1950, 1951), SCHOLANDER and SCHEVILL (1955), IRVING and HART (1957), KANWISHER and LEIVESTAD (1957), HART and IRVING (1959), IRVING and co-authors (1962), HART and FISHER (1964), KANWISHER and SUNDNES (1966), HARRISON and KOOYMAN (1968), IRVING (1969), BARENKO and co-authors (1970), MCGINNES and co-authors (1970), SOKOLOV (1971), WHITTOV and co-authors (1972, 1975) and MCGINNES (1975).

Examples of ambient thermal conditions considered acceptable to captive odontocetes are listed in Table 5-120.

Table 5-120

Water temperatures acceptable for captive odontocetes (Based on reports from several holding facilities)

Species	Temperature range (°C)	Species	Temperature range (°C)
<i>Delphinapterus leucas</i>	0-12	<i>Orcinus orca</i>	4-22
<i>Globicephala macrorhyncha</i>	13-28	<i>Phocoena phocoena</i>	5-20
		<i>Pseudorca crassidens</i>	13-28
<i>G. melaena</i>	4-28	<i>Stenella species</i>	17-28
<i>G. scammoni</i>	4-28	<i>Tursiops truncatus</i>	5-30

Salinity

The tolerance to salinity varies considerably in different species of pinnipeds and odontocetes. A few species normally live in fresh waters, e.g. the seal *Phoca foetida sibirica* (Baikal Lake, USSR) and the dolphin *Platanista gangetica* (Gela Bil River, India; see also Volume II, p. 800). Other forms such as the harbour seal *Phoca vitulina* and the white whale *Delphinapterus leucas* live in coastal waters and often spend appreciable periods of time in estuaries; they are rather tolerant to temporary freshwater exposure. On the other hand, most inhabitants of typical marine environments may respond sensitively to sudden salinity reduction or to fresh water. In general, odontocetes tend to be less tolerant to salinity variations than pinnipeds.

In marine odontocetes, prolonged exposure to fresh water may be dangerous. The skin of a dolphin exposed to fresh water for 72 hrs showed structural changes and became 'waterlogged' (HARRISON, personal communication). According to ANDERSEN (1973), 2 *Phocoena phocoena* transferred from 20‰S to fresh water revealed severe skin maceration within 1 week; the outer skin layers could be rolled off in small granules.

Most coastal marine mammals tolerate salinities between 20 and 39‰S and often do well in salinities as low as 15 to 19‰S. Open-sea mammals should be kept at salinities close to 35‰S. Properly made-up artificial sea water (pp. 29-37) is usually well accepted. The marine mammals' capacity for non-genetic adaptation

to salinity variation has not yet been examined. Conceivably, gradual transfer to reduced salinity will lead to substantial adjustments, comparable to those observed in a variety of euryplastic invertebrates or fishes (Volume I, Chapter 4).

Several authors have discussed aspects of dietary water requirements and of osmoregulation in marine mammals, but a definite picture on water and salt regulation has not yet emerged. The absolute requirements of pinnipeds and odontocetes for metabolically available water are unknown. Apparently, some of the water required is taken up with the food: several marine invertebrates and practically all teleost fishes maintain an internal osmoconcentration considerably below that of sea water (Volume I, Chapter 4). However, pinnipeds such as the walrus *Odobenus rosmarus*, which feeds primarily on bivalve molluscs, and odontocetes such as *Globicephala melaena* and *Grampus griseus*, which feed primarily on squid, could hardly obtain low-salinity water via their food: their prey animals are more or less isosmotic with the surrounding sea water. Hence, metabolic water production, possibly primarily due to fat metabolism, must be assumed to play a major role in their water and salt balance.

While marine mammals do not seem to drink substantial amounts of sea water, they do take up some sea water, at least during feeding. Some cultivators offer captive pinnipeds fresh water for drinking, and *Odobenus rosmarus* has been shown to definitely require fresh water (COATES and ATZ, 1958; ATZ, 1961; CRANDALL, 1964). In coastal forms, drinking of brackish water and fresh water may assist in water and salt regulation (e.g. IRVING and co-authors, 1935; SMITH, 1936; DECOPAS and co-authors, 1971).

Prolonged starvation and diarrhoea must be assumed to cause critical water deficiency. This assumption has not yet been tested critically; it requires attention from physiologists. After force-feeding, pups of *Phoca vitulina* have been reported to go straight to the water's edge and to deliberately drink sea water, apparently taking 2 or 3 mouthfuls (CANSDALE, 1970).

Exposure to subnormal salinities may cause a variety of functional and structural disorders, including corneal opacity, skin damage, electrolytic imbalance, and central-nervous-system disturbances. Extreme salinity stress (e.g. prolonged fresh-water exposure) can lead to severe salt deficiency and may be lethal. Corneal opacity and skin maceration are usually reversible after sea-water exposure. Hence, some operators of freshwater pools allow pinnipeds to dip their heads in a bucket of sea water once a week, give them a rub down with a sea-water-soaked sponge, or sprinkle sea water on them from time to time.

In the pinnipeds *Zalophus californianus*, *Callorhinus ursinus* and *Eumetopias jubata*, HUBBARD (1968 and personal communication to GERACI, 1972b) observed, after a 2-week captivity period in fresh water, weakness and loss of appetite. Haematologic and serum biochemical findings appeared normal, except for decreased Na, K and Cl, and increased blood-urea nitrogen concentrations. Fluid therapy, together with vitamin and antibiotic treatment, corrected the electrolytic imbalance. *Z. californianus* and *Phoca groenlandica*, kept in fresh water over a 4-year period, experienced episodes of electrolytic imbalance characterized by low plasma-sodium concentrations (GERACI, 1972b); clinical manifestations ranged from mild to severe central-nervous-system disturbances. Seals on a low-salt diet (marine fishes contain sodium in the order of 0.3 to 1.5 mg g⁻¹) tend to become gradually hyponatremic and, in combination with stress (moult, avitaminosis), salt imbalance

may cause severe neurophysiological breakdown. In contrast, KEYES (1968) reports that *Z. californianus*, *Mirounga* spp. and *Odobenus rosmarus* have been kept in fresh water for years without apparent harm.

Salt deficiency due to prolonged exposure to subnormal salinities or fresh water must be counteracted via dietary salt supplementation. However, for neither pinnipeds nor odontocetes is reliable, quantitative information available. For pinnipeds, GERACI (1972b) assumes a daily dose of 3 g NaCl kg⁻¹ body weight to be sufficient for maintaining plasma electrolyte concentrations at normal or near-normal levels. Where necessary, this dose may have to be increased 2- or 3-fold. The NaCl (physiologic saline solution) is administered *per os* or parenterally. Northern elephant seals *Mirounga angustirostris* kept in freshwater pools have been given dietary salt supplementation in the form of tablets placed in the mouth of the food fish (POURNELLE, 1962). Six to 8 g, of salt day⁻¹ turned out to be adequate for a 1800-kg bull.

For counteracting skin parasites (KINNE (in press)), pinnipeds and odontocetes have sometimes been exposed for hours or a few days to fresh water or significantly reduced salinities. Such treatment may be combined with the application of chemicals (e.g. Piperazincitrate, 60 g, for 1 *Delphinapterus leucas* every 6 weeks: BARTMANN, 1974).

Disinfection

Effective methods for disinfecting the culture water include microfiltration, irradiation, application of heat and application of chemicals; for details consult Chapter 2, pp. 102-107, pp. 161-164. Of these methods, microfiltration and application of heat and pressure are restricted to small water volumes. Irradiation of culture water passed through ultra-violet discharge boxes (Fig. 2-86, p. 163) has yielded good results in invertebrate and fish cultivation, but has not yet been employed in marine mammal facilities. Among the chemical methods, chlorination ranks highest in marine mammal cultivation, but ozonation (Fig. 2-84, p. 158, Fig. 2-85, p. 159) may also be useful.

Chlorination (below) and application of copper (p. 1081) are detrimental for invertebrates and fishes. Consequently, where these animals are maintained together with mammals in the same tank or in the same sea-water system, mechanical (p. 112), biological (p. 122) and/or physico-chemical water treatment (p. 134) must be employed.

For controlling skin sores and infections of pinnipeds, the pool water has been treated with such chemicals as Roccaldimethyl benzyl ammonium chloride (5 ppm), which is also an effective algicide, but toxic to invertebrates and fishes, and Cyncal, Type 14 (5 ppm). On the following pages we are primarily concerned with the disinfection of culture water in odontocete pools. Odontocetes depend more on rigid water-quality standards than their amphibian relatives.

Chlorination

Chlorination—practically not employed in plant, invertebrate and fish cultivation—is of considerable importance for culture-water disinfection in marine mammal facilities. Chemistry, methods and other aspects of chlorination have been reviewed by FAIR and co-authors (1948) and WHITE (1972). Accounts on chlorination immediately pertinent to marine mammal cultivation have been presented by

ANDERSEN (1973) and MANTON (1974 and in press). Three forms of chlorine have been distinguished: (i) free chlorine, i.e. chlorine in the form of liquid hypochlorous acid HOCl plus hypochlorite ion OCl^- ; free chlorine constitutes the most effective form of chlorine which is odourless, tasteless and largely non-toxic; (ii) combined chlorine, i.e. combinations of chlorine and nitrogenous compounds; (iii) total chlorine, i.e. free plus combined chlorines. All compounds are measured in terms of equivalent elemental chlorine (Cl_2) in ppm or mg l^{-1} . Although definite statements regarding the permissible or desirable chlorine levels in marine mammal facilities are still difficult to make (see below), the information available suggests that free chlorine levels between 0.1 and 0.3 ppm are appropriate for inactivating microbial pathogens without doing recognizable harm to the mammals.

Chlorine will not be present in the water as Cl_2 unless its concentration amounts to about 1000 ppm or unless the pH drops below 3. At lower chlorine concentrations and above pH 3, the disinfectant agent is the hypochlorous acid HOCl which dissociates:



Sodium hypochlorite dissociates in water according to the equation:



The dissociation of HOCl, which exerts about 100 times the disinfectant capacity of OCl^- , and of OCl^- is pH dependent (Fig. 5-124). Compared to the distribution prevailing at pH 4, the HOCl compound drops to 75% at pH 7, to 50% at pH 7.5 and to ca 20% at pH 8.

Most delphinid culture systems are characterized by heavy loads of nitrogenous waste products. Ammonia derivatives combine with chlorine to form chloramines which are much less disinfective than is HOCl, and which complicate the chlorination process. Chloramine formation proceeds as follows (FAIR and co-authors, 1948):

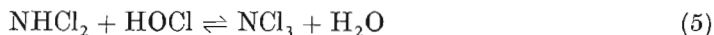
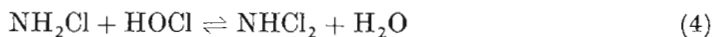

The dissociation of monochloramine (NH_2Cl), dichloramine (NHCl_2) and trichloramine (NCl_3) is a function of pH. At pH values below 4, NCl_3 dominates; at pH 7.8 to 8.2 NH_2Cl dominates. As ANDERSEN (1973) has pointed out, the relative distribution of chloramines also depends on the concentration ratio of chlorine to ammonia—N. At ratios less than 5:1, NH_2Cl amounts to almost 100% of total chloramines; between the ratios 5:1 and 10:1, NHCl_2 concentrations increase, and at ratios exceeding 10:1, NCl_3 may be formed. The disinfective capacity of NH_2Cl is about 100 times lower than that of HOCl. NHCl_2 is a somewhat better disinfectant than is NH_2Cl , but it escapes more easily from the water during agitation, e.g. due to splashing caused by dolphin movements, and produces a disagreeable odour. NCl_3 should not be present in the tank water; it has a very bad smell and irritates soft tissues, especially the eyes. According to ANDERSEN, the presence of ammonia and N-chloro compounds in the culture water causes: (i) irritation to mucus membranes; (ii) disagreeable odour; (iii) 'consumption' of chlorine and hence

reduction of disinfective capacity; (iv) growth of bacteria and fungi. It is essential, therefore, to counteract nitrogenous waste accumulation in closed systems by biological water treatment (Chapter 2, p. 92, p. 122), mechanical water treatment (p. 112) and physico-chemical water treatment (p. 134).

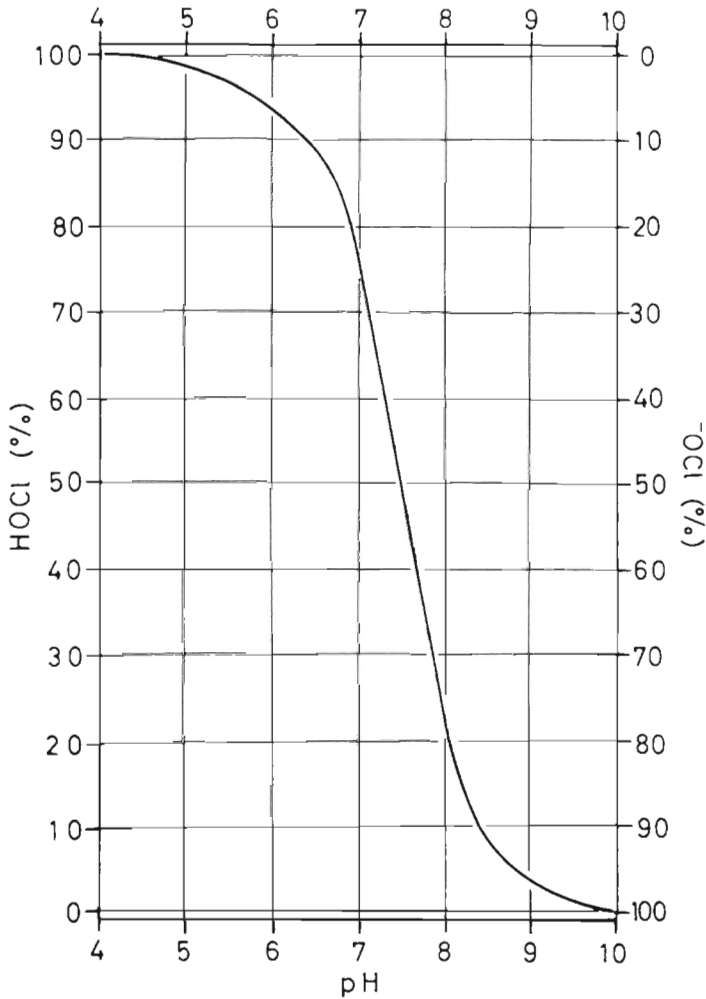

Fig. 5-124: Dissociation of hypochlorous acid (HOCl) and hypochlorite (OCl^-) as a function of pH. (After ANDERSEN, 1973; modified; reproduced by permission of Dolfinarium Harderwijk.)

The principal dynamics of chlorination are illustrated in Fig. 5-125. The dotted line shows the amount of free chlorine in distilled water; the other lines refer to conditions in dolphin-pool water: marginal chlorination (left to the breakpoint), breakpoint chlorination, and free residual chlorination (free chlorine and combined chlorine). As more and more chlorine is added to culture water containing a fixed concentration of nitrogenous compounds, the total chlorine concentration (almost

exclusively consisting of combined chlorine present as monochloramine) rises to a maximum. Thereafter, the concentration of combined chlorine begins to decrease and is replaced by free chlorine which increases sharply after the breakpoint. Further chlorine addition causes a rise in free chlorine proportional to the amount of chlorine added, i.e. parallel to the distilled-water curve (ANDERSEN, 1973). The actual 'utilization' of free chlorine by the culture water is a function of salinity (MANTON, in press). Apparently, the most efficient utilization of free chlorine occurs above 31·3‰S.

In dolphinarium, the levels of nitrogenous compounds are often so high and variable that breakpoint chlorination is not easy to achieve. In order to reach the breakpoint, it may be necessary to raise the concentrations of free and combined chlorine to levels that could be detrimental to the dolphins. According to ANDERSEN (1973), nothing has been published on the tolerance of dolphins to high concentrations of

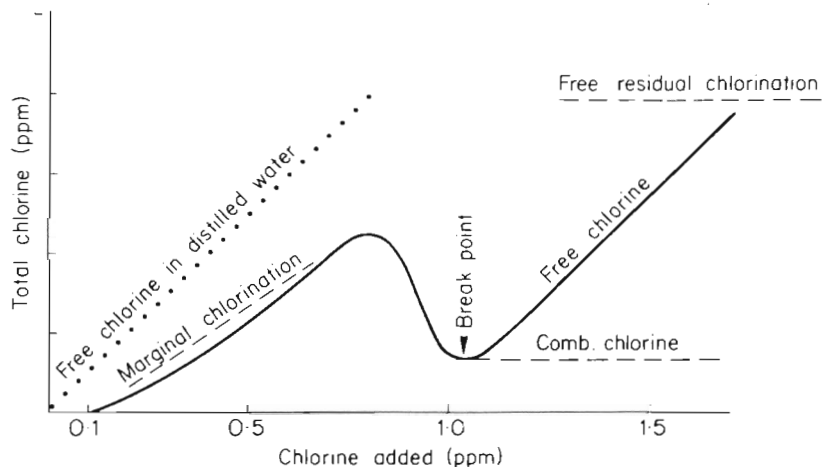

Fig. 5-125: Principal dynamics of chlorination. (After ANDERSEN, 1973; modified; reproduced by permission of Dolphinarium Harderwijk.)

free and combined chlorine. DUDOK VAN HEEL (personal communication to ANDERSEN) reports that *Tursiops truncatus* can tolerate 20 to 30 ppm free chlorine as long as the chloramine concentration remains below 2 ppm. ANDERSEN recommends keeping well to the right of the breakpoint; if the chlorine concentration is allowed to shift back and forth through the breakpoint, the dangerous di- and tri-chloramines may be formed. While a free chlorine concentration of >0.1 ppm inactivates most bacteria in human swimming pools within a reasonable period, a minimum concentration of 0.2 ppm free chlorine, combined with hyperchlorination, is considered necessary in dolphin tanks.

During nightly hyperchlorination, the dolphins must be separated from the main part of the culture-water body to which large quantities of chlorine are added. After reaction, the water is dechlorinated (application of hydrogen peroxide or sodium thiosulphate). While the upper free chlorine concentration permissible for captive dolphins may be close to 0.2 or 0.4 ppm at pH 7.8 to 8.2, definite statements require taking the local ammonia and combined chlorine values into consideration.

In order to avoid skin irritation, the pH should be raised with increased chlorine concentration. As a rule of thumb, ANDERSEN (1973) recommends pH 7.3 to 7.5 for free chlorine concentrations of ca 1.5 to 2.5 ppm with free residual chlorination; pH 7.7 to 7.8 for ca 0.3 ppm free chlorine with marginal chlorination. Employing 'breakpoint' chlorination techniques, WALLIS (1973) maintained a free chlorine residual between 1.0 and 2.0 ppm, and a total chlorine residual of 1.5 to 3.0 ppm, with no apparent detrimental effects to his dolphins.

Critically high levels of combined chlorine cause irritation of soft tissues, mucus-secreting membranes, eyes and skin, and very high concentrations lead to suffocation. HOCl is non-toxic to mammals even at concentrations of 50 ppm and hence is an ideal disinfectant. ANDERSEN (1973) points out that it is difficult to differentiate between the ordinary and rapid skin peeling of newly caught dolphins and skin damage due to chlorination. However, he has seen severe skin maceration resulting in deep grooves and the loosening of large, thick skin pieces due to accidental liberation of elemental chlorine in the culture water.

Liberation of elemental chlorine in the culture water (sometimes erroneously referred to as 'chlorine explosion' by dolphin keepers) can occur in outdoor pools exposed to intensive sun radiation under the influence of ultra-violet radiation, if chloride and acid are mixed; if chlorine in high concentrations comes into contact with iron; or if the pH drops below 5 (ANDERSEN, 1973).

In large dolphinariums, dissolved sodium hypochlorite can be administered by using a bucket. In smaller installations, it is imperative to use a dosage pump. Gas chlorination is usually preferred in large facilities over sodium-hypochlorite application. Using an electrolytic plate-type cell (platinised titanium anode; mild steel cathode), which operates on an 8 volt/500 ampere rectifier and is capable of producing 0.5 kg of gaseous chlorine hr^{-1} , the Brighton Dolphinarium (p. 1066) has reduced its annual chlorination cost from £90,000 (sodium hypochlorite) to £6000 yearly (WALLIS, 1973). For best results, continuous chlorine addition is recommended.

Application of copper

Copper is often added, usually as sulphate, to the culture water of marine mammal facilities in order to (i) inactivate or kill potential chlorine-resistant disease agents including parasites (KINNE (in press)), and (ii) reduce or eliminate algal blooms. Especially in tanks exposed to high levels of illumination, algicides, such as copper sulphate, constitute important means for counteracting water discolouration and underwater-visibility reduction. However, according to FITZGERALD (1959), chlorine exerts a broader action spectrum on different algal strains than does copper sulphate.

Copper sulphate should be applied at concentrations ranging from 0.2 to 0.5 ppm.

Application of aluminium

As has already been pointed out (p. 1072), aluminium is applied to the culture water of dolphinariums as a flocculating agent. According to ANDERSEN (1973), there are no records on the toxicity of aluminium to captive dolphins.

In order to avoid aluminium accumulation, flocculating aluminium compounds

should be removed and not allowed to pass the filter. In human swimming pools, 0.1 mg aluminium l⁻¹ begins to irritate the eyes, and 0.5 mg l⁻¹ acts as acute irritant.

(f) Nutritional Requirements

Proper nutrition of captive marine mammals often holds the key to successful cultivation. Inadequate food quality, daily rations (p. 1090) and feeding schedules (p. 1092) seem to be responsible to a significant degree for the fact that many cultivated marine mammals do not yet attain survival spans congruent with their natural life expectancies (p. 1054). Unfortunately, feeding habits and food preferences exhibited under natural conditions are still insufficiently investigated for many species and our knowledge on the chemical composition of the major food animals requires deepening. Feed-animal composition is a function of source, season, capture technique, processing and conserving (freeze-storage, p. 1084).

Much of the feeding practice employed by marine mammal facilities is based on empiricism. Some gifted or even ingenious practitioners have worked out diets, daily rations and feeding schedules which have led to admirable husbandry success. Regrettably, very few have published their techniques. Sometimes commercialism has restricted the free flow of information and reduced the readiness to share knowledge.

In order to compensate for nutritional shortcomings or to provide medical treatment, a variety of encapsulated substances have been administered with the food. The capsules are placed in the food fish (through mouth, gill slits or through cuts made in its body) immediately before feeding. The prepared fish is then hand-fed to each mammal to be treated.

In diets composed of, or including, freshwater fishes, iodine may have to be administered. Pending quantitative experiments, GERACI (1975) recommends adding 0.06 to 0.09 mg of elemental iodine kg⁻¹ of lean body weight. If gadoid fishes are offered as the main or sole food source, iron may have to be added. GERACI suggests the use of rapidly absorbed, commercially available haematinic preparations or gelatin capsules containing 50 mg of a ferrous salt (i.e. ferrous sulphate) plus 200 mg of ascorbic acid which enhances iron absorption. The iron preparation should be administered at a rate of 1 capsule 50 kg⁻¹ body weight day⁻¹. Pinnipeds maintained in freshwater pools require salt supplementation (see also p. 1077). GERACI recommends providing 2 to 3 g NaCl kg⁻¹ of fish. Vitamin supplementation receives special attention on p. 1085.

Field studies have revealed that the nutritional requirements and feeding activities of pinnipeds and odontocetes are subject to annual variation. Rhythmic migratory activities, skin shedding (p. 1060) and reproduction (p. 1115) appear to represent the most important factors which affect nutritional dynamics as a function of time. In most species, neither annual nor diurnal variations in food uptake have been studied in depth. An exception is the study by WADA (1971) on Northern fur seals *Callorhinus ursinus* along the coast of Sanriku. Feeding schedules prescribed for captive marine mammals do not normally take into account the natural temporal dynamics.

Food Storage

Marine mammals require large amounts of food. For practical reasons, dead feed animals are used in most cases. These must be stored over considerable periods of time. During storage, protein denaturation, enzymatic degradation and microbial decomposition tend to modify food quality. Such modifications may reduce or eliminate essential food components (e.g. amino acids, vitamins) which cannot be auto-synthesized by the mammal. Food storage may also lead to the formation of substances usually not present—at least not in significant amounts—in the natural food. These substances may disturb normal functions or be acutely toxic. Since synthetic diets with a defined chemical composition and a long shelf life are not available, the changes occurring in stored feed animals are of basic importance in the nutrition of cultivated marine mammals.

In order to avoid or reduce changes in stored feed organisms, newly caught food must be immediately quick frozen to ca -38° or -40° C and then stored at temperatures between -30° and -35° C. This procedure requires high-capacity, deep-freeze facilities, e.g. a quick freezer, a large deep-freeze room and a small thawing compartment for preparing the daily food rations. Slow freezing or storage at too high temperatures causes a large variety of changes in chemical composition, texture and flavour which have not yet been investigated in detail. However, CONNELL (1961) has shown that fish protein is rather labile and denatures rapidly. During cold storage, thawing and refreezing must be avoided. Refrozen food should not be used.

GERACI (1975) has reviewed some of the changes occurring in stored food. He distinguishes between changes in protein and other nitrogenous compounds, in lipids and in vitamins, as well as the formation of toxic substances.

Protein hydrolysis, liberates amino acids. Some of these may be lost due to 'drip'; others support bacterial contamination or undergo decarboxylation and turn into potentially dangerous amines (e.g. tyramine, putriscine, cadaverine, histamine). Histamine accumulation has caused gastric ulcers in *Tursiops truncatus* (GERACI and GERSTMAN, 1966) and depressed growth rate in chicks (SHIFRINE and co-authors, 1959). Amines produce foul aromas and reduce protein digestibility. The nitrogenous compound trimethylamine oxide (TMAO) is involved in osmoregulation in fishes. In improperly stored fishes, bacterial and autolytic enzymes reduce TMAO to trimethylamine and further to formaldehyde and formic acid (AMANO and YAMADO, 1965), especially in dark-fleshed species (TOKUNAGO, 1970) and in gadoids. In stored cod, muscle formaldehyde concentrations may range from $0.1 \text{ mg (100 g)}^{-1}$ to $15 \text{ mg (100 g)}^{-1}$. Since formaldehyde has an affinity for red blood cells (MALORNY and RIETBROCK, 1965), it may be involved in 'gadoid anaemia' syndromes.

Changes in lipids can be significant in stored fishes. At -4° to -7° C, enzymatic fat degradation proceeds rapidly. In lean fishes, cleaving or hydrolytic reactions prevail; in fat fishes, oxidative rancidity (BROWN and co-authors, 1957; LISTON and co-authors, 1963). Fatty-acid oxidation results in undesirable products such as carbonyl compounds. The peroxide fraction, a considerably more noxious product, may induce severe intoxication.

Reductions in vitamin content, such as that of vitamin E, are accelerated by fat oxidation, while high concentrations of vitamin E retard fat oxidation (DRAPER, 1970). Vitamin E-deficiency phenomena in pinnipeds and odontocetes are still incompletely understood. In addition to vitamin E, vitamins A, B and other vitamins are reduced or destroyed in improperly stored fishes (p. 1085).

Toxic substances have been subdivided by GERACI (1975) into endogenous toxins (known, for example, from puffer fishes, moray eels, many 'ciguatera'-containing fishes, or molluscs) which usually are not made available to captive marine mammals, and exogenous toxins, primarily produced by microbial activities. Microbial diseases and microbial toxins receive attention in LAUCKNER (in press).

Table 5-121

Suitability of properly packed fresh food items for freezing and cold storage at -17.8°C (Based on SLAVIN, 1963, and KEYES, 1968)

High storage life (7 to 12 months)	Moderate storage life (5 to 9 months)	Low storage life (4 to 6 months)
Haddock	Ocean perch	Mackerel
Cod	Whiting	Tuna
Flounder	King, red, or coho	Catfish
Hake	salmon	Sea herring
Shrimp	Lake herring	Spanish mackerel
Halibut	Red snapper	Pacific sardines
King crab	Smelt	Clams
Pollock	Dungeness crab	Chub
Sea scallops	Crawfish	Chum or keta salmon
Blue pike	Rockfish	Whale meat
Yellow perch	Carp	
	Buffalofish	
	Swordfish	
	Pacific oysters	
	Alewives	
	White bass	

KEYES (1968) has compared the suitability of various fishes used as pinniped food for freezing and cold storage (Table 5-121). He recommends that lean food fishes such as haddock or cod should be stored at least at -18°C , fatty fishes such as mackerel, herring or tuna at -30°C or still lower temperatures (see also SLAVIN, 1963). Maximum quality of frozen fishery products can only be obtained by careful handling prior to freezing, cleanliness, proper packaging (e.g. polyethylene, cellophane, polyvinylidene chloride, aluminium foil), and at high storage humidities (90–95%).

Thawing procedures must avoid unnecessary loss of important nutritive components, vitamins and flavour. It seems best to thaw wrapped food packages in a 'dry' state at temperatures between 4° and 8°C . Thawing in fresh water results in

heavy losses of essential substances; thawing in cold sea water may be acceptable, but is less desirable than dry thawing. It is imperative to keep the thawing time to a minimum, to clean the thawed food quickly and to feed it as soon as possible. During and immediately after thawing, bacterial populations increase explosively and initiate additional quality changes.

Vitamins

The vitamin requirements of pinnipeds and odontocetes invite investigation. In most cases, vitamins, especially of the B group, are offered because they are considered to be necessary, but without unequivocal experimental proof. We do not even know whether pinnipeds and odontocetes require external sources of vitamin C.

No definite information on average vitamin contents in food species has come to the reviewer's attention. However, fishes and crustaceans are regarded as fairly good sources of B vitamins, especially B₁₂ (cyanocobalamin) (BRAEKKAN, 1962; see also p. 1017), and of vitamin C. In fishes, vitamins are usually found at high concentrations in dark-fleshed species such as mackerel (GERACI, 1975). Apparently, the vitamin contents of food animals vary considerably, even within the same species. Major denominators of such variability include food origin, season and storage.

While live or very fresh food animals usually meet the mammals' vitamin requirements, the quality of dead food deteriorates due to capture, handling and storage (p. 1083). Stored food fish tend to lose their vitamin content and thus may cause vitamin deficiencies, especially in the absence of nutritional diversity.

Fat soluble vitamins—notably vitamins A, D and E—are found in relatively high concentrations in many aquatic animals (SUGII and KINUMAKE, 1968). Fishes such as the herring may contain ca 8000 I.U. of vitamin D, 2000 I.U. of vitamin A and 40 to 60 mg of vitamin E (tocopherol). For details consult GRANGUARD (1950) and CRUICKSHANK (1962).

Vitamin B₁ (thiamine) deficiency constitutes a permanent threat to captive marine mammals. Rarely, if at all, observed in wild populations, thiamine deficiency is caused primarily by supranormal concentrations of thiaminase. This enzyme occurs in live fishes and accumulates to critical levels in dead ones. Thiaminase, together with some other substances, inactivates thiamine in the mammal's body. DEOLALKAI and SOHONIE (1957a, b) found thiaminase in all 16 salt-water fishes examined by them; they suggest that there are at least 3 different thiaminases and that thiaminases are activated by amines. In dead fishes, considerable amounts of amines are formed as a result of bacterial decomposition. Unless newly caught food fish are immediately deep-frozen and unless the fishes thawed after freeze-storage are immediately fed, the mammals cultivated are likely to be subjected to supranormal thiaminase levels and hence to thiamine deficiency. According to GERACI (1975), the mammal's thiamine depot is continuously inactivated upon contact with the swallowed fish in the stomach. GERACI classifies clupeiformes (herring, smelt, anchovy) and cypriniformes (chub, carp, shiner) as being rich in thiaminase, but the enzyme is also found in other fish groups and in bivalve molluscs (FUJITA, 1954).

Thiamine deficiency was first recognized on the Chastek Fur Farm, Minnesota (USA) in fur-bearing mammals such as mink, ferrets and foxes fed solely on frozen fish, i.e. carp, herring, mackerel, mullet, pike, sucker, smelt (RUNNELS, 1954). Hence, often referred to as Chastek paralysis, thiamine deficiency begins with weakness, repeated regurgitation and anorexia. Later stages are characterized by emaciation, diarrhoea and the beginning of paralysis; advanced stages, by disorientation and prominent paralysis, rapidly followed by death.

In captive marine mammals, thiamine deficiency has been clearly demonstrated only in a few cases, e.g. in *Zalophus californianus* fed frozen whiting (RIGDON and DRAGER, 1955), in *Phoca vitulina* fed frozen *Clupea harengus* (A. HOLTMANN, personal communication), in *P. groenlandica* fed an experimental diet of *C. harengus* and *Osmerus mordax* (GERACI, 1972a), and in *Tursiops truncatus* kept on raw fish (WHITE, 1970). In *Z. californianus*, 2 of the 3 individuals concerned showed nerve degeneration and 1 individual cardiac lesions typical of beri beri in man.

According to GERACI (1975), many fishes contain thiaminase levels sufficiently high to destroy all of the supplemental thiamine added to the fish diets in the form of multi-vitamin preparations. In fact, some of the less potent multi-vitamin preparations would have to be administered in quantities well over 100 capsules day⁻¹ in order to counteract the destructive capacity of the enzyme (GERACI, 1968).

The exact thiamine requirements of marine mammals are not known. Current knowledge suggests that a mammal of the size of a *Tursiops truncatus* should be given a daily amount of 50 mg vitamin B₁ when offered very high quality food, and up to ca 250 mg when sustained on less high food qualities. According to GERACI (1972a, 1975), 2 to 5 mg of thiamine (1000 Cal. of food)⁻¹ day⁻¹ is protective when administered 2 hrs before feeding, but a dose of 25 to 33 mg of thiamine (1000 Cal. of food)⁻¹ day⁻¹ is required when incorporated in the diet. Of these two methods, GERACI prefers the former. Swine require 1.1 mg of thiamine kg⁻¹ of feed (MAYNARD and LOOSLI, 1956), and mink 1.2 mg kg⁻¹ of basal diet (LEOSCHKE and ELVEHJEM, 1959).

Vitamin E (alpha-tocopherol) requirements seem to be high in marine mammals, especially in exclusive fish-eaters. Fish oils are highly polyunsaturated, and diets rich in polyunsaturated fats have been shown to be compatible for mammals (rats) only if offered together with high levels of vitamin E (WITTING and HORWITT, 1964). According to MAYNARD and LOOSLI (1956), food deficient in alpha-tocopherol causes muscular dystrophy (e.g. in calves, lambs), structural deformation (turkeys), encephalomalacia (chicks) and impaired reproduction (several mammal groups). For swine and mink fed raw fishes, RUNNELS (1954) reports steatitis (yellow fat disease). In mink offered a diet consisting of up to 85% of fish, steatitis can be prevented by administering 10-20 mg of vitamin E individual⁻¹ day⁻¹ (JONES, 1954).

The exact amount of vitamin E required by marine mammals is not known. According to GERACI (1975), vitamin E may be required in daily doses as high as 50 to 100 I.U. kg⁻¹ of food (1 International Unit = 1 mg).

Vitamin B₁₂ (no details on quantity available) has been administered to captive *Tursiops truncatus* when the dolphins show signs of 'sluggishness' (GRAY, 1962).

A captive *Phoca vitulina* group reproducing successfully over many years in the

aquarium of the Biologische Anstalt Helgoland (FRG) thrives well on B-vitamin-complex dragees (BVK, Roche forte) hidden in the fish offered (A. HOLTSMANN, personal communication). Unless the food fish (herring) are fresh or deep frozen immediately after the catch, 1 dragee per week is administered to each ca 1.3- to 1.6-m long individual if fed fat herring; 2 dragees if fed lean herring; juveniles (1.1 to 1.2 m) receive $\frac{1}{2}$ dragee week⁻¹. One dragee contains vitamin B₁ nitrate, 15 mg; vitamin B₂, 15 mg; vitamin B₆ hydrochloride, 10 mg; nicotinamide, 50 mg; calcium-D-pantothenate, 25 mg; biotin, 0.15 mg; cyanocobalamine, 0.01 mg.

Vitamin C (ascorbic acid) should be provided regularly. Several investigators (personal communications) suggest applying quantities comparable to those consumed by humans. Vitamin K has also been offered by several facilities. Pups of *Phoca vitulina* have been given each day 1 vitamin pill (Vibolex*) in a food fish for 1 month (CANSDALE, 1970).

Force Feeding

In newly caught mammals, force feeding often becomes necessary. It is usually done by forcing the jaws open, and either gently pushing soft fresh food items down the throat (e.g. CANSDALE, 1970; GEWALT, 1970; LESLIE, 1971), or inserting a soft stomach tube through which liquified food is gravity-fed through a funnel, or pumped into the stomach.

Care must be taken to avoid undue force. Individuals which struggle and gasp must be allowed to quieten down until they breathe normally again before force feeding can begin or be continued (HUBBARD, 1968). In addition, HUBBARD observed the action of the fed pinnipeds' nostrils: as long as they remain closed, it may be impossible to insert a fish or a stomach tube into the trachea. The fish offered should be wet to facilitate swallowing.

During force feeding, seal pups are often held between the knees of a seated attendant; their mouth is forced open with the left hand and the tube carefully lowered with the right hand. The liquid diet (p. 1104) is then poured into a funnel by an assistant. After 1 week, fresh herring pieces or whole fish may be gently pushed down the throat, using rubber gloves for protection. In some cases, a stomach tube may be difficult to place (e.g. POULTER and co-authors, 1965); proper insertion requires knowledge on anatomical and behavioural details. Since pinniped pups are usually very reluctant to accept objects unfamiliar to them, and frequently resist even mild restraint, training them to accept a nipple is not easy. It may help to cover the nipple with a familiar material and to formulate nursing diets with acceptable taste and odour. In general, phocid pups are easier to nurse than are otariid pups. Pups of the harbour seal *Phoca vitulina* have also been force fed without a stomach tube: in this case, the attendant presses one of his knees carefully but firmly on the pup's back in order to keep the pup in place; he then bends the pup's head upward, opens its mouth using thumb and fingers of his left hand, and pours a generous amount of liquid diet into the mouth cavity. The mouth is kept open with the left hand while the tongue root is pressed down repeatedly with the thumb of the right hand until the whole mouthful of diet has been swallowed. The pup is then released from the

* Manufactured by W. B. Cartwright Ltd, Rawdon, Leeds, Yorkshire.

Table 5-122

Examples of daily rations offered to and considered adequate for captive odontocetes. Vitamin supplements only stated where specific information was available. Lactating females and individuals exposed to subnormal temperatures require higher rations (Compiled from the sources indicated)

Species	Main food offered	Daily ration (kg)	Author
<i>Delphinapterus leucas</i> 2-9 m	Mackerel (vitamin, mineral, cod-liver oil supplementation)	10 possibly more	GEWALT (1970)
<i>Inia geoffrensis</i> 1-7 m	Smelt <i>Osmerus mordax</i> or catfish <i>Ictalurus</i> sp. supplemented daily with a multi-vitamin capsule, a brewer's yeast tablet, cod-liver oil and wheat germ oil perles	3-6	CURTIS (1962a)
1-9-2 m		5-7	GEWALT (personal communication)
<i>Orcinus orca</i> 4-11 m; 1088 kg	Initially: salmon, bonita and mackerel, later only bonita and mackerel	36-63	BURGESS (1968)
<i>O. orca</i> 6-6 m; 3600 kg	Salmon or other fish native to Puget Sound	200	GRIFFIN and GOLDSBERRY (1968)
<i>O. orca</i> 4-4 m; 1100-1300 kg	Lingcod, herring, salmon	45-63	HEWLETT and NEWMAN (1968)
<i>O. orca</i> 4-4 m	Herring, mackerel; occasionally cuttlefish and a 'special' multi-vitamin, mineral and anabolic hormone supplement	54	TAYLOR (1971)

<i>Phocoena phocoena</i> ca. 1.5 m	Herring, cod, eel, mackerel; <i>Clupea sprattus</i> , <i>Ammodytes tobianus</i> , <i>Zoarces viviparus</i> , <i>Trachurus trachurus</i>	4 in summer 5-7 in winter	ANDERSEN (1965)
<i>Platanista indii</i> ca. 1.8 m	<i>Leuciscus leuciscus</i>	4-6	PILLERI (personal communication) GEWALT (1969, 1973)
<i>Tursiops truncatus</i> 3 m; 130 kg	Herring, mackerel, cod (once a week 2 capsules 'Protovita' plus 1 Tablet B ₁₂ 'Vicotrat')	6-7	JONCH (1965) and others
<i>T. truncatus</i> 2.4 m; 150 kg 2.3 m; 140 kg 2.1 m; 100 kg 2.0 m; 80 kg	First: Sead <i>Trachurus trachurus</i> , later: mackerel <i>Scomber scombrus</i> ; 3 daily meals. 1 multi-vitamin tablet day ⁻¹ containing A ₁ , B ₁ , B ₂ , B ₆ , B ₁₂ , C, D ₁ , niacinamide, pantothenic acid	5-6 (in cold water 15-17)	
<i>T. truncatus</i> average size	Apparently primarily herring	7-9	GRAY (1962)
<i>T. truncatus</i>	Bluerunner, butterflyfish, herring, mullet, Spanish mackerel, common mackerel	a lactating female may require as much as 14 to 16	Florida Department of Natural Resources (undated mimeo)
<i>T. truncatus gilli</i> 3 m	Mackerel	15-20	GEWALT (1973)

knee pressure, allowed to close its mouth, to lower its head and to relax for several minutes, before receiving the next mouthful of liquid diet.

Captive belugas *Delphinapterus leucas* have been force fed after emptying the pool to a point where the whales lay on the bottom with their backs out of the water (BARTMANN, 1974): while one attendant sat on the whale's back and kept its head jammed between his knees, a second attendant opened the jaws and pushed the fish (mackerel, herring) as far down the throat as possible. Then the mouth had to be closed for a moment to allow swallowing. The beluga's only defensive movement consisted in moving its head sideways.

Two unweaned harbour porpoises *Phocoena phocoena* have been force fed after lifting their head slightly out of the tank water (ANDERSEN, 1974a). A 15-mm-diameter horse stomach tube was then gently forced down along the palate and quickly passed beyond the point where the natural regurgitation reflex is elicited. From the tip of the jaw, the tube reached down some 30 cm. The nursing diet (p. 1113) was poured into a household cake-icing set attached to the tube, and the piston of the food-ration plunger pressed down slowly; fast plunger action sometimes caused vomiting.

Force-fed mammals must learn to feed on their own as soon as possible. For this purpose, it may help to introduce live fish to the pool, gradually adding more and more dead ones. Newcomers may also learn to accept dead food animals by copying the feeding behaviour of their captivity-adjusted counterparts.

Daily Ration

The daily ration, i.e. the total amount of food consumed per day, tends to be larger in rapidly growing individuals than in adults, and relatively larger in small-sized species than in large-sized ones. Subnormal temperatures, excessive locomotory activities and lactation normally lead to increased daily-ration requirements.

The daily ration for captive marine mammals should perhaps best be expressed in terms of calories or joules. However, the information available is usually not sufficient for recalculating the data presented. Most authors have expressed daily rations either as percentage of the mammals' body weight or as kg of food consumed.

In most captive pinnipeds, the average daily ration amounts to some 5 to 8% of their body weight. However, suckling calves, early juveniles and pregnant females may require 8 to 12%. On the other hand, old individuals and very large forms (e.g. walrus, elephant seals) get along with daily rations of some 2 to 5% of their body weight. Some of the information available on the daily rations fed to adult captive pinnipeds may be summarized as follows: *Arctocephalus pusillus*, 6 to 7 kg; *Eumetopias jubatus*, male: 23 kg, female: 15 kg; *Halichoerus grypus*, male: 7 to 10 kg, female: 6 to 7 kg; *Mirounga angustirostris* and related species, male: 20 to 40 kg, female: 20 kg; *Otaria byronia*, male: 10 kg, female: 7 kg; *Phoca vitulina*, 2.5 kg (in Helgoland Aquarium, a 1.5-m-long male has received a daily ration of 2.6 kg herring day⁻¹ for 18 years); *Zalophus californianus*, male: 9 kg, female: 7 kg. The daily rations are usually somewhat reduced during summer and when fat fish are available; they are increased during winter.

Expressed in terms of body weight, the daily rations required by captive odontocetes may vary from about 4 to 14% (Tables 5-122, 5-123). Small forms such as *Phocoena phocoena* have the highest daily-ration requirements (ca 9 to 14%).

Table 5-123
 Daily rations consumed by captive Delphinoidea. Information based on literature search and correspondence (After SERGEANT, 1969)

Species	Number of individuals	Location	Mean body length (m)	Mean body weight (kg)	Mean daily ration (kg)	Mean daily ration (% body weight)	Number of daily meals
<i>Phocoena phocoena</i>	8	Strib, Denmark	1	40	4.3	10.8	3-4
<i>Lagenorhynchus obliquidens</i>	2	Vancouver, British Columbia	2	87	6.8	8.0	?
<i>Phocoenoides dalli</i>	1	Pt. Mugu, California	2	120	15	12.5	5
<i>Tursiops truncatus</i>	2	Pt. Mugu, California	2	168	7.0	4.2	2
<i>Globicephala macrorhyncha</i> juv.	1	Marineland, Florida	1	ca 190	24.1	12.7	?
<i>Delphinapterus leucas</i>	2	Vancouver	2.8	238	23	9.6	2
<i>Delphinapterus leucas</i>	4	New York City	3.4	468	23	4.9	?
<i>Pseudorca crassidens</i>	1	Marineland of the Pacific, California	3.6	437	20.9	4.7	?
<i>Globicephala scammoni</i>	3	Vancouver	5	842	33.2	4.8	?
<i>Orcinus orca</i>	4	Sea World, Calif.	4.75	1258	51	4.05	?

Medium and large forms, ranging in size between *Tursiops truncatus* and *Orcinus orca*, require ca 4 to 8%. In captive Indus dolphins *Platanista indi*, meteorological influences have been claimed to affect the daily ration (GIHR and co-authors, 1972); apparently, the factors determining such weather sensitivity do not include direct relationships to temperature, humidity or atmospheric pressure.

Feeding Schedule

The daily ration should not be offered in one but in several meals. Good results have been obtained, both in pinnipeds and odontocetes, with feeding schedules providing the daily ration in 2 to 4 meals. Primarily for practical considerations, most cultivators feed their mammals once or twice a day.

While there are numerous reports on feeding schedules, a few examples suffice here. A 4.6-m male Southern elephant seal *Mirounga leonina* was fed a total of

Table 5-124

Feeding schedule for raising suckling *Phocoena phocoena* to hand-fed juveniles (After ANDERSEN, 1974b; reproduced by permission of Dolfinarium Harderwijk)

Days after catching	Number of daily meals	Weight of each meal (g)	Main dietary component	Type of feeding
1	1	200	Herring mash	Tube feeding
2-7	6-8	200	Herring mash	Tube feeding
8-22	6-7	200-250	Small herring	Force feeding
23-53	4-5	300-500	Small herring	Force feeding
54-68	3	700-800	Herring	Force feeding
69-73	3	500	Herring	Force feeding
Thereafter	3	800-1000	Herring	Hand feeding

27.2 kg fish day⁻¹, offered in 2 meals. The meals consisted of *Poronotus triacanthus*, *Cynoscion regalis*, *Scomber scombrus*, *Alosa sapidissima*, *Pomolobus mediocris*, *P. pseudoharengus*, *Pomatomus saltatrix* and *Roccus lineatus* (ULMER, 1962). A 1800- to 2300-kg male Northern elephant seal *Mirounga angustirostris* consuming a daily ration of 18 to 27 kg of fish (*Scomber diego*), usually received 3 meals day⁻¹ (POURNELLE, 1962). A 370-kg (2.8-m) male hooded seal *Cystophora cristata*, sustained on a daily ration of 32.5 kg of freshly caught herring, is reported to have developed well on 2 daily meals (EHLERS, 1965).

Suckling juvenile pinnipeds (p. 1104) and odontocetes (p. 1111) initially require 4 to 6 meals day⁻¹; later, 2 or 3 meals are sufficient. An example of a feeding schedule devised for suckling *Phocoena phocoena* is presented in Table 5-124; for details concerning dietary components and feeding techniques consult p. 1113.

Non-digestible Items Swallowed

Both in the field and in captivity, pinnipeds and odontocetes often swallow non-digestible items. There are numerous reports on stone and rock ingestion, and

several speculations have been presented regarding the possible significance of this phenomenon (e.g. SCHEFFER and NEFF, 1948; RAND, 1959; MATHISEN and co-authors, 1962; KING, 1964; NESTEROV, 1964; SPAULDING, 1964; NAKAJIMA and co-authors, 1965; FISCUS and BAINES, 1966; PANINA, 1966; HARRISON and KOOYMAN, 1968; HUBBARD, 1968; KEYES, 1968; NISHIWAKI, 1972; RIDGWAY, 1972b). While no satisfactory explanation is yet available, the frequent swallowing of stones, particularly in pinnipeds, suggests that this habit may have a biological function.

In captive pinnipeds and especially in captive odontocetes, a large variety of non-digestible items swallowed have been recovered post mortem. Captive odontocetes have swallowed almost everything thrown or fallen into their tank as long as they could handle it, e.g. coins, nails, hairpins, ear-rings, watches, pipes, knives, flash bulbs, toys, bottles, tin cans, gloves, towels, plastic bags, and—in one case—even an American football. According to ANEMIYA (1962), an adult *Tursiops truncatus* lived with a swallowed, inflated football in its stomach for 5 months when it died, apparently from a long cold spell. With the ball in its stomach, the dolphin had displayed normal appetite. However, in many cases (ca 10 to 20%), swallowed non-digestible foreign items seem to have caused death. A female pilot whale *Globicephala scammoni* apparently died from swallowing a stone. Necropsy suggested that the stone induced laryngeal occlusion (BROWN, 1962). In a *Tursiops truncatus*, a swallowed screwdriver caused fatal oesophageal ulceration (HARRISON, personal communication).

In odontocetes, the indiscriminate swallowing of non-digestible foreign items may be related to (i) their poorly developed gustatory—olfactory senses (Volume II: KINNE, 1975, p. 738); (ii) excitement during performance; (iii) conditioning to accept food pieces thrown into the tank; (iv) a drive to supplement monotonous diets. In order to protect captive mammals from detrimental consequences of foreign-item swallowing, the public and attending personnel must be warned not to drop any items into the tank nor to make them otherwise available to the mammals.

Feeding Pinnipeds

Even though several pinnipeds have been studied at sea or sustained in captivity for many decades, their feeding habits are insufficiently known. Our present knowledge is largely based on stomach-content analyses in wild individuals, and on empiric husbandry in captive representatives. Critical experiments on essential nutrients have still to be conducted. Consequently, the cultivator seems well advised to provide a certain amount of dietary diversity and to administer vitamins in order to avoid long-term nutritional deficiencies. Important reviews on pinniped nutrition have been presented by KEYES (1968) and GERACI (1975).

Adults

While most adult pinnipeds seem to be nutritional opportunists feeding on a wide variety of fishes, crustaceans and molluscs, several exhibit definite dietary preferences and may be classified as specialists, e.g. the crabeater (krilleater) seal *Lobodon carcinophagus*, which feeds primarily on euphausiids, and the walrus *Odobenus rosmarus*, which feeds mainly on bivalve molluscs. However, captive

Table 5-125

Food items of pinnipeds under natural conditions and in captivity. n.i.: no information available (Largely based on KEYES, 1968; compiled from the sources indicated)

Family, genus, species	Natural food	Locality	Author	Food offered in captivity*
Otariidae				
<i>Arctocephalus doriferus</i> Australian fur seal	Mainly: Crustaceans, e.g. <i>Jasus lalandei</i> ; squid and fishes (e.g. barracouta). Also: gurnets, parrot fish, salmon, trout	Victoria coast	LEWIS (1929) MCNALLY and LYNCH (1954)	n.i.
<i>A. forsteri</i> New Zealand fur seal	Mainly: barracouta, octopus, squid	New Zealand	STREET (1964)	n.i.
<i>A. pusillus</i> South African fur seal	Mainly: fishes (79% mostly pilchards and maasbanker), cephalopods (53%), crustaceans (19%)	South Africa	RAND (1959)	$\left\{ \begin{array}{l} \textit{Johnnis hololepidotus}, \\ \textit{Trachurus trachurus}, \\ \textit{Merluccius capensis}, \\ \text{herring, cod, Atlantic} \\ \text{herring, whiting, hake} \end{array} \right.$
<i>A. tropicalis gazella</i> Kerguelen fur seal	Mainly: euphausiids (krill) Also: Fishes, cephalopods		NISHIWAKI (1972)	
<i>Callorhinus ursinus</i> Northern fur seal	Mainly: herring, squid Also: lamprey, salmon, rockfish, sand lance, sablefish, stickleback, birds Mainly: anchovy, hake, squid, saury Mainly: herring, capelin, pollock, sand lance, squid, deep-sea smelt	British Columbia (Canada) California (USA) Pacific coast of Alaska	SPAULDING (1964) FISCUS and KAJIMURA (1967) Quoted in KEYES (1968)	Herring, mackerel, squid, cod, anchovy smelt, white bait smelt, mud suckers (live for weaning)

Mainly: pollock, squid, Atka mackerel Mainly: squid, pollack, salmon, trout, cod, herring, sardines, silverside, Japanese smelt, sand lance, ocean perch, rockfish, lamprey	Sea of Japan, Okhotsk Sea	Quoted in KEYES (1968) NISHIWAKI (1972)	
<i>Eumetopias jubatus</i> Steller's sea lion	Pribilof Islands (USA) St. Paul Island, Alaska (USA) Canadian waters Shumagin Islands, Alaska (USA)	LUCAS (1899) WILKE and KENYON (1952) PIKE (1958) MATHISEN and co-authors (1962)	Spanish mackerel, smelt, squid, striped mullet, Pacific herring, Pacific mackerel, white-bait smelt, American smelt
Mainly: local common crab, sculpins Sand lance, starry flounder, sculpins, halibut, cod, pollock Herring, rockfish, squid, octopus, skate, hake, salmon, halibut, black cod Squid and octopus (35% of total stomach volume), fishes (27%: mainly smelt, rockfish, greenling, sculpins; rarely lamprey, salmon, sand lance); bivalves (20%); shrimps and crabs (8%). Mainly: cephalopods Flatfish, rockfish Capelin, sand lance, rockfish, sculpins, flatfish Atka mackerel, sand lance, rockfish, whiting, squid, octopus	Commander Islands (USSR) California, Oregon (USA) Alaska (USA) Kurul Islands (USSR)	NESTEROV (1964) FISCUS and BAINES (1966) FISCUS and BAINES (1966) PANINA (1966)	
Penguins (<i>Eudyptes</i> sp.)	Macquarie Island (Australia)	CSORDAS (1963)	n.i.
<i>Neophoca hookeri</i> New Zealand sea lion			

Table 5-125—Continued

Family, genus, species	Natural food	Locality	Author	Food offered in captivity*
<i>N. cinerea</i> Australian sea lion	—	—	—	Mainly: striped mullet; also: fantail mullet, mackerel, 'Cowanyoung', Pacific bonito
<i>Otaria byronia</i> Southern sea lion	Spider crab, squid, fishes, medusae, birds (Pups: small crustaceans, sea squirts)	South America	HAMILTON (1933, 1934)	n.i.
<i>Zalophus californianus</i> California sea lion	Squid, octopus Squid, fishes Herring, squid Hake, anchovies, squid	Monterey Bay, California (USA) California (USA) California (USA) California (USA)	DYCHE (1903) BONNOT (1928) SCHEFFER and NEFF (1948) FISCUS and BAINES (1966)	Herring, mackerel, smelt, squid
Odobenidae <i>Odobenus rosmarus</i> Walrus	Molluscs (<i>Astarte</i> sp., <i>Clinocardium nuttalli</i> , <i>Macoma calcareo</i> , <i>Mya</i> <i>truncata</i> , <i>Neptunea</i> sp.; echinoderms (<i>Malpodia</i> <i>arctica</i>) Annelids (<i>Nephtys</i> sp.); sipunculids, priapuloids (<i>Priapulus caudatus</i>) Molluscs, e.g. <i>Mya truncata</i> , <i>Saxicava arctica</i> , <i>Cardium</i> <i>groenlandicum</i> , <i>Clinocardium</i> <i>nuttalli</i>	Bering Strait, Point Barrow area, Alaska (USA)	BROOKS (1952, 1954)	<i>Spisula solidissima</i> , <i>Caspiolosa</i> sp., <i>Clupea</i> sp., <i>Merluccius</i> sp., <i>Coregonus</i> <i>albula</i> , <i>Clupeonella</i> sp., <i>Osmerus eperlanus</i> (mackerel, whiting, sardine)
		General statement	NISHIWAKI (1972)	

Phocidae					
<i>Cystophora cristata</i> Hooded seal	Shrimp, mussels, octopus, squid, sea-stars, rosefish, herring, capelin, cod	—	KING (1964)	n.i.	
<i>Erignathus barbatus</i> Bearded seal	Shrimp, crabs, hermit crabs, arctic cod, clams	Alaska (USA)	JOHNSON and co-authors (1966)	n.i.	
<i>Halichoerus grypus</i> Grey seal	Mussels, crustaceans, cuttlefish, saithe, cod, pollock, conger eel, toadfish, lumpfish, seatrout, salmon, halibut, herring, lythe, flounder, mackerel, skate, ray, dogfish Mainly: shrimp, cod, herring, salmon, hake, flounder. Also: squid, dogfish Mainly: Rockfish, pollock, halibut, lamprey, salmon, herring, conger eel, flounder and other flat fishes. Also: some crustaceans and molluscs	Scottish waters Maritimes (Canada) General statement	Quoted in RAE (1960) FISHER and MACKENZIE (1955) NISHIWAKI (1972)	Herring, mackerel, whiting (sardines)	
<i>Histiophoca fasciata</i> Ribbon seal	Mainly: pollock and other deep-water fishes, cephalopods	Sakhalin Island (USSR)	ARSENIEV (1941)	n.i.	
<i>Hydrurga leptonyx</i> Leopard seal	Penguin, carrion, seal, fish, crustaceans, whale, diving petrel (<i>Pelecanoides</i> sp.)	Falkland Islands	HAMILTON (1939a)	Mainly: Striped mullet, but also fantail mullet, mackerel 'Cowanyoung', Pacific bonito	
<i>Leptonychotes weddelli</i> Weddell seal	Mainly: Nototheniid fishes, cephalopods (Pups: crustaceans)	Graham Land, Ross Sea (Antarctic)	BERTRAM (1940)	n.i.	

Table 5-125—Continued

Family, genus, species	Natural food	Locality	Author	Food offered in captivity*
<i>Lobodon carcinophagus</i> Crabeater seal	Euphausiids (krill)	Graham Land	BERTRAM (1940)	n.i.
<i>Mirounga angustirostris</i> Northern elephant seal	Fishes (ratfish, skates, sharks), squid	—	KING (1964)	Mackerel, smelt, squid, herring
<i>M. leonina</i> Southern elephant seal	—	—	—	Mackerel, sardines, <i>Octopus</i> sp., herring, whiting, occasionally <i>Ommastrephes sagittatus</i> , (meat of <i>Mytilus edulis</i>)
<i>Monachus schauinslandi</i> Hawaiian monk seal	Cephalopods, fishes (mainly species of <i>Notothenia</i>)	Falkland Islands (U.K.)	LAWS (1956a)	—
<i>Monachus schauinslandi</i> Hawaiian monk seal	Octopus, moray eels, conger eels, flatfish, puffers, goatfish	Hawaii (USA)	RICE (1964)	Mackerel, smelt, moray eels, squid, reef fish, tuna, herring, akule (sardines)
<i>Ommatophoca rossii</i> Ross seal	Cuttlefish, euphausiids, fishes	Weddell Sea (Antarctic)	BROWN (1915) KING (1964)	n.i.
<i>Pagophilus groenlandicus</i> Harp seal	Mainly: Herring, flatfish; Also: shrimp witch, plaice larger plankters	Magdalen Islands (Canada)	FISHER and MACKENZIE (1955)	n.i.
<i>Phoca vitulina</i> Harbour seal	Mainly: fishes, predominantly flounders, herring, tomcod, hake, sculpins, pollock, shiners, cod, rockfish (93%)	Puget Sound (Canada)	SCHOFFER and SPERRY (1931)	Herring, mackerel, smelt, squid (sand eel, sardines, red fish)

Also: molluscs (5.8%), crustaceans (0.6%) Eulaeohon, codfish, herring, flounder, shrimp Mainly: Rockfish, octopus, salmon. Also: small crabs, shrimp, herring, lamprey Mainly octopus	Copper river delta (Alaska) British Columbia (Canada)	IMLER and SARBER (1947) FISHER (1952)	
Mainly salmon, octopus, squid, herring, rockfish Atka mackerel, octopus	Amchitka Islands, Alaska (USA) British Columbia (Canada)	WILKE (1957) SPAULDING (1964)	
Fishes, molluscs, squid, octopus, crustaceans	Amchitka Island, Alaska (USA) General statement	KENYON (1965) NISHIWAKI (1972)	
Pelagic amphipods (<i>Themisto libellula</i>), schizopods (<i>Mysis oculata</i>) Wide variety (72 species) of planktonic, nectonic and benthonic animals Pelagic amphipods, euphausiids and other crustaceans, small fishes	Baffin Island (Canada) Eastern Canada Arctic Ocean General statement	DUNBAR (1941) McLAREN (1958b) NISHIWAKI (1972)	Herring, mackerel, cod (sardines)
<i>Pusa hispida</i> Ringed seal	—	—	Sprat (herring, white fish)
<i>Pusa sibirica</i> Baikal seal	—	—	—

* According to KEYES' (1968) survey of feeding practices in 34 zoos and public aquaria; additions are given, where available, in parentheses.

Table 5-126

Approximate percentages of major components contained in food animals fed to captive pinnipeds (After GERACI, 1975; modified; reproduced by permission of Conseil International pour l'Exploration de la Mer)

Family, genus, species	Type*	% Moisture	Proximate composition		
			% Protein	% Oil	% Ash
Fishes					
Clupeidae (herrings)					
<i>Clupea harengus harengus</i> (Atlantic herring)	F B	61.8-69.0	15.4-19.7	7.5-19.4	1.06-2.1
<i>Clupea harengus pallasii</i> (Pacific herring)	F A	79.4	17.5	2.6	1.2
Engraulidae (anchovies)					
<i>Engraulis</i> sp. (anchovy)	W B	73.3-78.2	16.1-19.3	1.2-4.8	2.63-4.41
Gadidae (codfishes & hakes)					
<i>Gadus morhua</i> (Atlantic cod)	F A	81.2	14.6-17.6	0.2-0.6	1.2
Osmeridae (smelts)					
<i>Mallotus villosus</i> (capelin)	W E	77.1-82.3	12.9-15.0	1.8-8.1	—

<i>Osmerus mordax</i> (American smelt)	W	E	77.6-81.1	11.3-18.6	1.6-4.7	1.1-2.9
Scombridae (mackerels & tunas)						
<i>Scomber japonicus</i> (Pacific mackerel)	F	B	69.8	21.9	7.3	1.4
<i>Scomber scombrus</i> (Atlantic mackerel)	F	B	67.5	11.0-19.0	6.2-13.0	1.5-1.6
Stromateidae (butter fishes)						
<i>Poronotus triacanthus</i> (butter fish)	W	A	71.4-80.7	14.6-18.6	1.0-14.8	1.49-3.01
Invertebrates						
<i>Euphausia superba</i> (shrimp)	M	A	79.95	17.75	1.31	1.43
<i>Loligo brevis</i> (squid)	M	A	80.2	16.4	0.9	1.0
<i>Spisula solidissima</i> (clam)	M	E	79.8-80.8	11.1-14.0	0.9-1.9	2.0-2.3

* M = meat; W = whole fish; F = fillet; A = <5% oil, 15-20% protein; B = 1-15% oil, 15-20% protein; E = <5% oil, <15% protein.

O. rosmarus can be trained to accept a mixture of fish, milk, cod-liver oil and vitamin mix.

The information available on feeding of wild pinnipeds is based on stomach-content analyses, on observations during actual feeding, and on faeces and vomitus examination (Table 5-125). The last column of the table contains information on food offered in captivity. Wild pinnipeds exhibit seasonal changes in the food consumed. Whether this is primarily a function of food availability or, perhaps less likely, of food preference remains to be investigated. Variations in the amount of food consumed per unit time depend—in addition to food availability—on age and life-cycle dynamics, especially migratory activities, skin shedding and reproduction. Fasting appears to be a regularly returning phenomenon, e.g. in breeding bulls. In captivity, refusal to accept food by non-moulting and non-breeding individuals is usually interpreted as a sign of disease. However, transport, unfamiliar food, new surroundings or isolation may also result in fasting. Fasting periods of 2 or 3 days are not uncommon.

On the basis of information obtained from 34 zoos and public aquaria in Australia, Austria, Belgium, Canada, England, Germany, Italy, Japan, New Zealand, South Africa, USA and USSR, KEYES (1968) determined that most cultivators did not collect the pinniped food themselves, but bought it from wholesale dealers and froze it for storage (see also p. 1083). The storage periods ranged from 1 week to 1 year. Trimming (e.g. removal of fish heads or tails) was done by only about 33% of the consultees. Some rolled the food fish in cod-liver oil and vitamin mix, especially for newly weaned seal pups, or dipped the fish in a lubricative mixture of sea water and cod-liver oil or seal oil.

The approximate percentages of major components contained in feed animals fed to captive pinnipeds are listed in Table 5-126. Moisture content refers to the free water available upon digestion; it does not include the additional water becoming available during digestive oxidation (GERACI, 1975). Moisture content is important because it represents the only or major source of fresh water.

According to HUBBARD (1968), captive pinnipeds often exhibit fastidious feeding habits. Once accustomed to a certain food organism, some individuals will fast rather than eat unfamiliar animals. Individuals used to eating whole fish often require to be trained to accept cut fish of the same species and vice versa. Apparently, size, shape and texture of the food play an important role. HUBBARD reports a *Mirounga angustirostris* to have rejected food fish if the fish's mouth gaped open too far, if a gill cover or a fin was out of place, if the tail was missing, or if the fish had an unusually severe bend in its body. In another *M. angustirostris*, BENCHLEY (1930) observed that if the fish 'starts down crooked' or gets stuck under the tongue, the elephant seal made no effort to straighten this out, but expelled the fish and waited to be fed a new one.

Prey catching in pinnipeds is assisted by the capacity of many forms to flex the neck (a posture usually concealed by external contours, especially in phocids) and to extend it very quickly to full length. This technique is comparable to the body bending and sudden stretching in fish larvae (p. 992) and known to exist also in several other predators. It facilitates a surprise attack, rapidly bridging the critical prey distance.

Table 5-127
 Composition of pinniped milk (in %). Usually mean values; n.d.: not determined (Compiled from the sources indicated)

Species	Total solids	Water	Fat	Protein	Lactose	Ash	Author
<i>Arctocephalus pusillus</i>	n.d.	n.d.	18.6	10.0	n.d.	n.d.	RAND (1956)
<i>Callorhinus ursinus</i>	63.6	36.4	51.1	11.3	0.10	0.49	ASHWORTH and co-authors (1966)
<i>Cystophora cristata</i>	50.2	49.9	40.4	6.7	n.d.	0.86	SIVERTSEN (1936, 1941)
<i>Halichoerus grypus</i>	67.7	32.2	53.2	11.2	2.60	0.70	AMOROSO and MATHEWS (1952)
<i>Leptonychotes weddelli</i>	n.d.	43.6	42.2	n.d.	n.d.	n.d.	KOOYMAN and DRABEK (1968)
<i>Pagophilus groenlandicus</i>	n.d.	43.8	42.8	11.9	n.d.	n.d.	SIVERTSEN (1936, 1941)
<i>P. groenlandicus</i>	54.9	45.1	46.9	6.8	0.77	0.39	COOK and BAKER (1969)
<i>Zalophus californianus</i>	n.d.	n.d.	15.5	18.9	n.d.	n.d.	SCHROEDER and WEDGEFORTH (1935)
<i>Z. californianus</i>	52.7	47.3	36.5	13.8	0.00	0.64	PILSON and KELLY (1962)

Suckling juveniles

Suckling juvenile marine mammals which are orphaned or not properly cared for by their mothers have been fed specially designed artificial nursing diets. In most cases, nursing diets have been developed with an eye on natural milk composition. The natural milk of pinnipeds and odontocetes contains 2 to 4 times more calories than milk of comparable terrestrial mammals; typically, it is rich in total solids and relatively poor in water; it contains high levels of fat but very little, if any, lactose (Tables 5-127, 5-128).

Table 5-128

Composition of milk of Steller sea lion *Eumetopias jubatus*. n.d.: not determined (Based on POULTER and co-authors, 1965)

Components	Silver analysis (%)	Pilson analysis (g 100 g ⁻¹)
Water	n.d.	61.8
Total solids	33.2	n.d.
Total ash	0.96	1.0
Total fat	20.9	20.0
Albumen	3.0	n.d.
Casein	8.3	n.d.
Total protein	n.d.	10.8
Protein N	n.d.	1.7
Non-protein N	n.d.	0.02
Total N	n.d.	1.7
Carbohydrate (as glucose)	n.d.	0.005
Lactose	0.0	n.d.
Specific gravity	n.d.	1.01
pH	6.3	n.d.
Acid calculated as lactic	0.45	n.d.
Refractive index of fat at 40° C	1.47	n.d.
Sodium chloride	0.24	n.d.
Sodium	n.d.	65.0
Chloride	n.d.	72.3
Calcium as CaO	0.19	n.d.
Calcium	n.d.	35.4
Potassium	n.d.	45.7
Magnesium	n.d.	29.0
Phosphorus as P ₂ O ₅	0.49	n.d.

The low water content may be a consequence of the need for water conservation by the cow rather than a nutritional requirement of the young (KROGH, 1939; KOOYMAN and DRABEK, 1968). Fat is needed for rapid blubber formation (heat conservation). Sea lions lack intestinal disaccharidase (KRECHMER and SUNSHINE, 1967). Hence, excessive dietary lactose causes digestive problems, diarrhoea and finally death. NEUGEBAUER (1967), who reared pups of the Southern elephant seal *Mirounga leonina* (p. 1107), assumes 2.4% lactose in the nursing diet to be close to the upper level tolerated. Synthetic nursing diets for pinnipeds and odontocetes are not yet available. However, PATASHNIK and KANGAS (1970) and SIMPSON and

LEATHERWOOD (1970) have experimented with synthetic, high-protein test diets. If successful, such diets (known composition, long shelf life, easy preparation in large amounts) would greatly reduce the effort required for rearing suckling marine mammals.

Pinniped nursing periods range from about 2 to 18 months. Newly borns must be fed 4 to 6 times day⁻¹; for older pups, 2 to 3 meals seem sufficient. Since good nursing diets require careful preparation, cold storage and small-portion-thawing, it requires one person on a full-time job to bring up 1 or 2 pinniped or odontocete orphans.

Table 5-129

General formula for artificial seal milk (Based on KEYES, 1967)

Component	Amount (%)
Protein	
Fish flour (fine grind for animal use, 73% protein)*	9.1
Casein (85% protein)†	4.5
Fat	
Whale oil (baleen, bleached triglyceride)‡	36.0
Water	49.5
Supplement	
BO-SE (R)§ selenium, and	0.00001
d-alpha tocopherol (vitamin E)	0.0075
DL methionine†	0.4
Glycerin¶	0.4
Antioxidant	
Ethoxyquin (Santoquin (R))	0.01
Emulsifier	
Lecithin (soy-bean, oil not removed)†	0.1

* VioBin Corp., Monticello, Illinois.

† Nutritional Biochemicals Corp., Cleveland, Ohio.

‡ Del Monte Fishing Co., San Francisco, California, and Technology Laboratory, BCF, Seattle, Washington.

§ Haver Lockhart, Kansas City, Missouri.

¶ Colgate-Palmolive Co., New York, New York.

|| Monsanto Chemical Co., St. Louis, Missouri.

The first case in which an otariid pup was successfully raised on a special diet from birth to over 1 year of age has been reported by KEYES (1967). His artificial nursery-diet formula (Table 5-129) is based on chemical analyses of natural fur-seal milk (ASHWORTH and co-authors, 1966). The fat (commercially available, bleached but not distilled whale oil) is stored in tins charged with nitrogen to prevent oxidation; unless the fat is emulsified, it separates out in the stomach, is regurgitated and inhaled; this may cause fatal foreign-body pneumonia (KEYES, 1968). To minimize fat oxidation between mixing and digestion, KEYES adds ethoxyquin.

According to KEYES (1968), the ingredients of his artificial seal milk can be stored at room temperature, but the milk should be fed within an hour after preparation. Protein and water are mixed for 10 to 15 secs; fat, emulsifier and antioxidant are

blended separately for 5 to 10 secs; then both mixtures are blended together for 10 to 15 secs. The supplement is calculated on an individual-per-feeding basis and added separately. KEYES started each pup on 60 ml dietary milk twice a day and increased this amount by 10 ml per feeding until reaching a total amount of 120 ml twice a day. On the 14th day, he increased the amount per feeding to 130 ml and by the 25th day to 150 ml twice daily. By the 40th day, the schedule was gradually changed to 300 ml once a day. During the first week, the pups lost about 0.5 kg weight while adjusting to the artificial diet; at the end of the second week, their weight was the same as at the end of the first week, and, thereafter, the pups gained weight at the rate of about 0.5 kg week⁻¹. Although seal pups can sometimes be taught to nurse an artificial nipple (assisted by the use of real seal milk and a natural skin over the nipple), KEYES considers it more practical, when working with more

Table 5-130

Formulae for artificial milk for Steller sea lion *Eumetopias jubatus* pups (A: Based on POULTER and co-authors, 1965, and KEYES, 1968; B: on BEST, personal communication to GERACI, 1975)

(A)	Component	Amount	(B)	Component	Amount
	Water	350 ml		Blended fish	700 g
	Whale oil (light baleen)	350 ml		Reconstituted synthetic human-infant formula*	500 ml
	Blended mackerel (headless)	220 g		Calcium caseinate	60 g
	Fish flour	80 g		Cod-liver oil	60 g
	Vitamin-mineral (Gerex-Walins)	6 capsules		Salmon (marine) oil	50 ml
	U.S.P. salt mixture XIV	1 g		NaCl	4 g
	Total	1000 g		Vitamin mix (plus 100 mg thiamine and 100 I.U. vitamin E)	

* Containing sucrose and corn syrup; both add unwanted disaccharides. However, according to GERACI (1975), this formula has been used with impunity.

than 2 or 3 individuals, to feed the pups by stomach tube as described by WILSON (1966; see also p. 1090).

There is considerable danger in overfeeding newborn captive seals (KEYES, 1968). Overfeeding may result in indigestion, vomiting and subsequent electrolytic imbalance, dehydration, coma and death. Next to overfeeding, KEYES mentions soiling of the fur as a major hazard. Soiling can be prevented by the use of wood-slat flooring and a tank for bathing. In seal pups, access to sea water may improve health and growth. Newborn pups usually take up hookworm larvae with their first milk. If not wormed, heavily infested pups may die from anaemia (see also KINNE (in press)).

The nursing diet developed by POULTER and co-authors (1965) allowed for the first time the successful rearing of orphaned *Eumetopias jubatus* pups to an age of over 1 year. The improved version of the diet is listed in Table 5-130, together with a formula recommended by BEST (personal communication to GERACI, 1975). Young *Zalophus californianus* have been sustained on a formula consisting of 300

g cod-liver oil and 150 g calcium caseinate (Casec R, Meade Johnson), mixed in 500 ml of water (BALDWIN, personal communication to KEYES, 1968).

In *Phoca vitulina* pups, the nursing period is short (ca 3 weeks). Hence, a specific nursing diet is of less importance. KEYES (1968) recommends early force feeding using small raw fish. Many *P. vitulina* pups may have survived in spite of, rather than because of, formula containing bovine milk. REINECK (1962) used minced fish (fresh herring) emulsified in a domestic mixer with warm water, supplemented by 'multivitamins'. This mixture was fed by stomach tube (rubber tube, ca 50 cm long, with a funnel attached at one end and with several holes at the other to facilitate good food flow into the stomach). Initially, ca 200 to 300 cm³ were fed 4 or 5 times day⁻¹; later, larger amounts were offered in 3 feedings day⁻¹. Very weak *P. vitulina* pups received half a bottle of Boviserin (Behring Werke, Marburg-Lahn, FRG) or a corresponding quantity of fresh ox-blood serum obtained from the slaughter house.

Calves of the walrus *Odobenus rosmarus divergens* have been raised by ALVING (1939) and REVENTLOW (1951) on filleted herring and some cod-liver oil. BROWN (1963) fed a liquid diet (containing per 4.45 l: 226.8 g calcium caseinate, 56.7 g brewer's yeast, 907.2 g diced clams blended with 1.7 l sterilized water, 2.27 l whipping cream and 28.4 g multivitamin syrup) during the first 2 years; in the following 2 years, the pups were weaned to a solid diet consisting of whole clams and bonita fillets (BROWN and ASPER, 1966). HAGENBECK (1962) fed *O. rosmarus* calves minced herring blended with emulsified cod-liver oil supplemented with Vitakalk (calcium plus vitamins), Vigantol and a few drops of a 10% solution of tincture of iodine. The daily ration offered in 3 meals contained 10 kg of herring and 0.5 l cod-liver oil. Later the diet was amended by one whole herring. The calves sucked off the herring flesh leaving the backbone. Finally, they learned to live entirely on whole herring. Adults received 20 kg of herring day⁻¹. In nature, the walrus sucks up food from the ground. COATES (1962) reared an *O. rosmarus* calf on a liquid diet rich in protein and fat, but with little or no lactose until the age of 1½ to 2 years. Whipping cream and clams were blended together until the mixture passed through a cross-cut sheep's or baby's nipple. Using a calf-feeding bucket, COATES fed the equivalent of ca 8 to 10% body weight day⁻¹ in 3 or 4 equal meals. As the calf aged over the year, raw fish and clams were added to the diet. The diet was enriched by vitamins and minerals (no details provided). After weaning, a basic diet was fed of raw clams *Spisula solidissima* and *Macra* sp.

In a letter to the reviewer (1976), DUDOK VAN HEEL pointed out that he and METTVIER MEYER (unpublished) have raised *Odobenus rosmarus* in the Harderwijk Dolfinarium (Holland) successfully on minced, filleted and, after 4 months, whole herring and mackerel, whiting and sardine, supplemented with 250 g calcium caseinate, 200 g herring oil, 100 g cod-liver oil, 20 g lecithine, vitamin/mineral supplements and water at a ratio of 1 l H₂O kg⁻¹ of fish. After 4 months, caseinate was left out, herring oil was reduced to 100 g, cod-liver oil to 50 g, and after 7 months herring oil and lecithine were left out altogether. Fresh water turned out to be an absolute requirement for walrus calves, no matter whether they are kept in fresh- or salt-water pools (see also p. 1076).

Captivity-born pups of the Southern elephant seal *Mirounga leonina* failed to survive on the nursery diet developed for *Phoca vitulina* by REINECK (1962; see above), but developed on the following formula (NEUGEBAUER, 1967): 1st day:

Boviserin plus fresh beef serum; from 2nd day on: cream (40%); Boviserin, Multimulin, plus A-muslin heated to body temperature. The daily ration was initially 29% of body weight (given in 3 meals); by the 21st day, it was 5% (given in 5 meals). From the 22nd day on, increasing amounts of minced mussel (*Mytilus edulis*), and from the 29th day on, minced herring were offered (Table 5-131). Gradually, the portion of herring was increased while that of cream and mussel was decreased until the pups were sustained on minced fish with just a small amount of cream. At the same time, the daily ration was increased to ca 9% body weight. NEUGEBAUER found it important to inspect the faeces; whenever the stool became too thin, the daily ration was immediately reduced.

RIDGWAY (1972b) brought up one *Zalophus californianus* and several *Phoca vitulina* on a simple formula—a homogenized mixture of 5 parts whole fish, 3.5 parts water, 0.5 part cod-liver oil and 1 part of essential fatty-acid supplement. The mixture was fed by stomach tube.

Table 5-131

Nursery diet for newly born pups of the Southern elephant seal *Mirounga leonina* (After NEUGEBAUER; 1967; modified; reproduced by permission of Zoological Society of London)

Age (days)	Body weight (kg)	No of meals day ⁻¹	Cream (40%) (g)	Boviserin (g)	Minced mussel	Minced herring	Added sea water (g)
11	29.2	4	220	35	—	—	—
20	30.0	5	260	40	—	—	—
25	30.5	5	250	40	70	—	—
30	33.0	5	200	30	110	110	30

Feeding Odontocetes

Adults

The natural food consumed by odontocetes consists mostly of fishes, molluscs and crustaceans (Table 5-132; see also AKIMUSHKIN, 1954a, b, 1955; GASKIN and CAWTHORN, 1967). Some odontocetes are fastidious feeders. Captive *Delphinapterus leucas*, for example, accepted only mackerel of about 40-cm length; 30-cm-long fish were refused (BARTMANN, 1974); also firmness and freshness of the fish turned out to be of great importance; cut-up fish were rejected.

As most pinnipeds, odontocetes swallow fishes head first, turning and mouthing the prey with their tongue if it enters the mouth the wrong way. Usually the fish is swallowed in toto; chewing seems to be restricted to 'play feeding', biting to crustaceans and other hard-shelled food. An incomplete or abnormally structured or textured fish is usually rejected. Odontocetes must be trained to accept fish pieces, and individuals adjusted to feed on pieces may have to be retrained to accept whole fish. As in pinnipeds, these facts suggest that size, shape and texture of the food play

Table 5-132

Food items of odontocetes recovered from stomachs of field-collected individuals
(Based on information provided by NISHIWAKI, 1972, and others)

Family, genus, species	Natural food
Physeteridae	
<i>Physeter catodon</i> Sperm whale	Mainly: squid. Also: fish (herring, mackerel, sardine, ocean perch), octopus
Kogiidae	
<i>Kogia breviceps</i> Pygmy sperm whale	Mainly: squid. Also: crabs
Ziphiidae	
<i>Berardius bairdi</i> Baird's beaked whale	Mainly: squid, benthic fishes. Also: ascidians, sea-cucumbers, sea-stars, crabs
<i>Hyperoodon ampullatus</i> Bottle-nosed whale	Squid
<i>Ziphius cavirostris</i> Cuvier's beaked whale	Mainly: squid. Also: demersal fishes, crabs, sea-cucumbers, sea-stars
Monodontidae	
<i>Delphinapterus leucas</i> Beluga, White whale	Mainly: fishes (often large benthic forms such as halibut and flounder). Also: squid, crabs
<i>Monodon monoceros</i> Narwhal	Mainly: squid. Also: cod, rock-fish, flounder, shrimp, crabs
Platanistidae	
<i>Inia geoffrensis</i> Amazon dolphin	Fishes, crustaceans
<i>Platanista gangetica</i> Susu, Ganges dolphin	Demersal fishes, shrimp
<i>P. indi</i> Indus dolphin	Fishes: <i>Wallago attu</i> ('Mali'), <i>Macrones aor</i> ('Singari'), <i>Catla buehanani</i> ('Marakho'), shrimp*
Delphinidae	
<i>Cephalorhynchus commersoni</i> Commerson's dolphin	Squid, euphausiids, fishes
<i>Delphinus delphis</i> Common dolphin	Mainly: fishes (herring, sardines). Also: squid
<i>Lagenorhynchus albirostris</i> White-beaked dolphin	Mainly: squid, octopus, cod, herring, capelin, small crustaceans. Also: snails
<i>L. obscurus</i> Dusky dolphin	Mainly: squid
<i>L. obliquidens</i> Pacific white-sided dolphin	Mainly: squid. Also: small pelagic fishes (e.g. anchovy)
<i>Lissodelphis borealis</i> Northern right whale dolphin	Mainly: squid, pelagic fishes
<i>Stenella caeruleoalba</i> Blue-white dolphin	Squid (<i>Loligo</i> sp.)
<i>Tursiops gilli</i> Gill's bottle-nosed dolphin	Mainly: fishes. Also: squid
<i>T. truncatus</i> Bottle-nosed dolphin	Mainly: fishes. Also: squid

Table 5-132—Continued

Family, genus, species	Natural food
Orcaelidae	
<i>Orcaella brevirostris</i> Irrawaddy dolphin	Fishes
Phocoenidae	
<i>Neophocoena phocoenoides</i> Finless black porpoise <i>N. asiaorientalis</i> <i>N. sunameri</i>	Mainly: small fishes, squid and shrimp (e.g. <i>Penaeus merguensis</i> , <i>P. penicillatus</i> , <i>Palaemon japonicus</i>)†
<i>Phocoena phocoena</i> Harbour porpoise <i>Phocoenoides dalli dalli</i>	
Dall porpoise <i>P. dalli truei</i> True's porpoise	
Grampidae	
<i>Grampus griseus</i> Risso's dolphin	Squid (Captive diet: at least 50% squid)
Globicephalidae	
<i>Globicephala melaena</i> Pilot whale <i>G. scammoni</i> Pacific pilot whale <i>Orcinus orca</i> Killer whale	Mainly: squid. Also: fishes (Captive diet: at least 50% squid) Mainly: squid. Also: fishes (e.g. mackerel) (Captive diet: at least 50% squid) Mainly: fishes such as salmon, cod, flat fishes, sardines, tuna, skipjack and squid. Also: Dolphins, whales, sharks, seals.
<i>Pseudorca crassidens</i> False killer whale	Mainly: squid. Also: fishes

* According to PILLERI and ZBINDEN (1973-74).

† According to PILLERI and GIHR (1975).

‡ The squid and crustaceans are most likely secondary stomach contents, e.g. from cod (S. ANDERSEN, personal communication).

an important role in food selection. Obviously, mechano-reception is significant in food examination and selection.

The literature on feeding of captive odontocetes is extensive and often highly repetitive. Hence, we restrict ourselves here to a few examples.

Dolphins such as *Tursiops truncatus* are usually sustained on mackerel or herring. *T. truncatus* have also been kept in good health on butterfish (*Poronotus* sp.) and blue runner (*Caranx crysos*) without additional food supplementation. Herbivorous fishes such as mullets turned out to be unsatisfactory, because of too low vitamin contents; a *T. truncatus* on a strict mullet diet will develop avitaminosis (WOOD in: NORRIS, 1966a, p. 659). *T. truncatus* and *Lagenorhynchus obliquidens*, fed only mackerel (*Scomber diego*), have developed mouth lesions. The lesions regressed after administration of high levels of ascorbic acid (MILLER and RIDGWAY, 1963).

Grampus griseus and *Globicephala melaena* whose natural diet consists primarily of squid (Table 5-132) should be sustained on diets consisting of at least 50% squid. Both odontocetes have been kept successfully on a mixture of fishes (e.g. mackerel and herring) and squid.

Orcinus orca often prefer salmon. Since salmon is expensive, most cultivators feed it only to newly caught individuals and gradually shift to less expensive and more readily available food fish such as mackerel, bonita, ling cod and herring. In *O. orca* requiring force feeding (p. 1087), a long soft tube (19-mm diameter) was inserted into the mouth and slowly pushed down the throat into the stomach. The tube was then connected with a pump and a thick ground-herring-water mixture (22 to 34 kg) pumped daily into the stomach (GRIFFIN and GOLDSBERRY, 1968; HEWLETT and NEWMAN, 1968). The natural diet of the Amazon dolphin *Inia geoffrensis* consists of fishes and crabs (e.g. *Poppiana argentinianus*; PILLERI, 1972).

Suckling juveniles

Morphological details of cetacean mammary glands, milk secretion and characteristics of the milk produced, as well as duration and mode of lactation in cetaceans have been reviewed in detail by ARVY (1973-74). The amount of milk secreted by cetaceans varies considerably. Usually it is rather large, thus meeting the high energetic requirements of newly borns. Surrounded by relatively cold water, newly borns must compensate for considerable heat losses until they have developed sufficient heat preserving body insulation.

Cetacean milk resembles cow milk to which cream has been added. In general, it is white, but may also be yellowish white, pale brown or, occasionally, pink (ARVY, 1973-74). Cetacean milk smells 'fishy' and tastes 'astringent' like a mixture of fish, liver, oil and milk of magnesia (SLIJPER, 1962, 1966). Although major milk components have been determined for a variety of species, mostly mysticetes, investigations on possible changes in composition during the lactation period have not yet been conducted. Due to a high lipid content, cetacean milk has a lower density (0.994 to 1.012) than human milk (1.032). According to ARVY, the milk's pH ranges from 4.6 to 6.4 (in *Stenella graffmani* and *S. microps* from 6.6 to 6.9; PILSON and WALLER, 1970). The milk composition of some odontocetes is listed in Table 5-133 and Table 5-134, and the milk-fat composition of *Tursiops truncatus* in Table 5-135. Milk analyses require critical attention. In several cases, dead individuals have been used, in others the methods of collection (sometimes also those of chemical analysis) must be considered inadequate. In *S. graffmani* and *S. microps*, there was no indication of changes in milk composition during the course of lactation (PILSON and WALLER, 1970). The chloride concentration is higher in the milk of these two species (46-47 mEq kg⁻¹) than in cow's milk, possibly correlated with the need of keeping the milk osmoconcentration close to that of the blood.

The average duration of lactation periods is longer in odontocetes (20-26 months) than in mysticetes (4-11 months). Milk transfer mechanisms have still to be explored in both groups. Upon proper mamma stimulation, the milk is apparently actively ejected by the lactating female. Possibly, the calf's mouth root and flexible tongue may form a funnel around the mamma opening.

Very little is known about the vitamin content of odontocete milk. Apparently,

Table 5-133

Composition of milk (in %) of odontocetes: mean values and single analyses. n.d.: not determined (Compiled from the sources indicated)

Species	Total solids	Water	Fat	Protein	Lactose	Ash	Author
<i>Delphinapterus leucas</i>	41	59	27	10.6	0.74	0.83	LAUER and BAKER (1969)
'Dolphin'	n.d.	45	35	10.6	0.9	0.53	SPECTOR (1956)
<i>Globicephala melaena</i>	51	49	n.d.	7.6	n.d.	0.5	FRANKLAND and HAMBLY (1890)
<i>Phocoena phocaena</i>	59	41	46	11.2	1.33	0.57	PURDIE (1885)*, GRIMMER (1925)
<i>Physeter catodon</i>	n.d.	55	n.d.	n.d.	n.d.	0.8	ZENKOVICH (1938; revised data)
<i>Stenella graffmani</i>	n.d.	n.d.	25	8.3	1.09	n.d.	PILSON and WALLER (1970)
<i>S. microps</i>	n.d.	n.d.	26	7.1	1.03	n.d.	PILSON and WALLER (1970)
<i>S. plagiodon</i>	30	70	18	9.4	0.63	n.d.	EICHELBERGER and co-authors (1940)
<i>Tursiops truncatus</i>	29	71	17	9.6	0.77	n.d.	EICHELBERGER and co-authors (1940)

* PURDIE states that the milk analyzed by him was blood contaminated; this fact may account for the relatively high lactose value.

ascorbic acid, vitamin B₁₂ and, especially, vitamin B₁ (thiamine) are present in much higher concentrations than in cow or human milk.

Two orphaned harbour porpoises *Phocoena phocoena* fed heavy commercial cream developed 'osmotic diarrhoea', due to high lactose levels, and produced faeces which looked like butter; they soon died (ANDERSEN, 1974b). However, ANDERSEN succeeded in rearing two other unweaned *P. phocoena* on a nursery diet consisting of 4 parts water, 3 parts chopped herring, and a multivitamin tablet plus 35 mg thiamine kg⁻¹ of herring. He deep-froze the resulting mixture in plastic bags with diet portions of 350 g each. Thawing was done immediately before each meal in lukewarm water and lasted ca 15 mins. The mash was then force fed (p. 1087) and provided in several meals per day (Table 5-124). During the first 7 days, the food was supplied per tube, then 60 days of hand force feeding (10- to 15-cm long herring) followed. In order to prepare the juveniles for normal hand feeding, the daily ration was reduced for 5 days. At the end of this period, the porpoises accepted hand feeding. Attending a suckling porpoise requires a suitable tank in which the baby can

Table 5-134

Milk composition (g l⁻¹) in *Stenella pernettyi*, *Tursiops truncatus* and man; n.d.: not determined (After EICHELBERGER and co-authors, 1940; reproduced by American Society of Biological Chemists, Inc.)

Species	Water	Proteins	Lipids	Sugar
<i>Stenella pernettyi</i>	690	94	180	6.3
<i>Tursiops truncatus</i>	714	96	167	7.7
<i>T. truncatus</i>	674	n.d.	148	n.d.
<i>T. truncatus</i> (at end of lactation)	756	111	108	3.9
Man	874	23	38	62.9

be easily caught and fed while the attendant is in the water. Apparently, *P. phocoena* suckle for about 2 to 4 months (SMITH and GASKIN, 1973; ANDERSEN, 1974b). Solid food uptake usually begins at a body length of 1.0 to 1.1 m.

A less-than-one-year-old baby *Mesoplodon bidens*, stranded on the beach of Ostend (Belgium) together with its moribund mother, was transported by DUDOK VAN HEEL (1974a) to his dolphinarium at Harderwijk (Holland). Here the baby was tube fed (p. 1090). Initially it received a daily ration (offered in 2 meals day⁻¹) of whipping cream, 500 cm³; water, 500 cm³; mashed herring and mackerel, 500 g; phosphatic and lactic acid calcium, 30 g; yeast flakes, 14 g; wheatgerm oil, 10 cm³; Gravitamon, 2 tablets; vitamin B₁, 100 mg; vitamin C, 40 mg; vitamin K₃, 20 mg. The baby recovered quickly and began to swim more and more vigorously. On the second day, it crashed into the pool wall, broke its rostrum and sank dead to the bottom. *M. bidens* is built to go fast and straight; it seems difficult, if not impossible, to accommodate it in small tanks with a radius of 15 m as at Harderwijk.

Toothless juveniles of *Orcinus orca* were sustained by GRIFFIN and GOLDSBERRY (1968) on a diet (offered in 3 meals day⁻¹) consisting of a ca 4-l (1 US gallon) mixture

Table 5-135

Milk-fat composition in *Tursiops truncatus*, expressed as weight percent fatty acids (After ACKMAN and co-authors, 1971; reproduced by permission of Prof. G. Pilleri)

Saturated acids		Monounsaturated acids		Polyunsaturated acids	
Fatty acid	%	Fatty acid	%	Fatty acid	%
12:0	0.30	14:1 ω 7	0.07	16:2 ω 7	0.07
Iso 14:0	0.20	14:1 ω 5	0.09	16:2 ω 6	0.11
14:0	3.15	15:1 ω 8	0.05	16:2 ω 4	0.60
4, 8, 12-TMTD*	0.09	Unknown	0.13	18:2 ω 6	1.23
Iso 15:0	0.18	16:1 ω 9	0.97	20:2 ω 6	0.16
Anteiso 15:0	0.05	16:1 ω 7	11.99	Total	2.17
15:0	0.42	16:1 ω 5	0.36	16:3 ω 4	0.09
Iso 16:0	0.15	17:1 ω 8	0.64	16:3 ω 3	0.11
Pristanic†	0.06	18:1 ω 11 + ω 9	19.55	18:3 ω 6	0.12
16:0	21.13	18:1 ω 7	3.48	18:3 ω 3	0.22
Iso 17:0	0.46	18:1 ω 5	0.05	20:3 ω 6	0.28
Anteiso 17:0	0.21	19:1 ω 9	0.07	20:3 ω 3	0.12
17:0	0.38	19:1 ω 8	0.09	Total	0.94
Phytanic‡	0.05	19:1 ω 7	0.11	16:4 ω 3	0.09
Iso 18:0	0.09	20:1 ω 11	2.20	16:4 ω 1	0.06
18:0	3.26	20:1 ω 9	5.70	18:4 ω 3	0.24
19:0	0.12	20:1 ω 7	1.08	18:4 ω 1	0.09
20:0	0.09	22:1 ω 13 + ω 11	2.19	20:4 ω 6	1.44
		22:1 ω 9	0.52	20:4 ω 3	0.38
		22:1 ω 7	0.05	21:5 (?)	0.15
		24:1 ω 9	0.05	22:4 ω 6	0.18
Total	30.21		49.44	Total	2.63
				20:5 ω 3	6.01
				22:5 ω 6	0.15
				33:5 ω 3	2.04
				Total	8.20
				22:6 ω 3	6.44
				Total	20.38

* 4, 8, 12-Trimethyltridecanoic

† 2, 6, 10, 14-Tetramethylpentadecanoic

‡ 3, 7, 11, 15-Tetramethylhexadecanoic

of whipping cream, multiple vitamin supplement, human baby food, warm water and small amounts of fish (no quantitative details available).

Rules

Rules for feeding captive marine mammals may be summarized as follows: (i) Attempt to simulate the natural diet. (ii) Offer more than one food source (e.g. several different food-fish species) in order to avoid acute nutritional deficiencies. (iii) Be patient in training a newcomer to accept unfamiliar food; if necessary apply

force feeding (p. 1087). (iv) Use fresh food animals or food stored under conditions which guarantee a minimum of decompositional changes. (v) All food animals must be deep-frozen immediately after capture in order to avoid excessive changes and to kill parasites: initial quick freezing to ca -36° to -40° C, storage at ca -30° to -35° C. (vi) Cleanliness in food handling and storage is absolutely imperative. (vii) Food from potentially polluted sea areas must meet standards higher than those for human consumption because the marine mammals are entirely sustained on sea food. (viii) Provide the daily ration in several meals per day and avoid over-feeding.

(g) Reproduction

Successful reproduction of captive marine mammals has remained a rarity—at least an achievement worthy of publication. As has already been pointed out, architecture and construction of culture enclosures have been dictated more by practical considerations—exhibit qualities, manageability, investment costs commensurate with the income expected—than by the animals' natural needs. The discrepancy between exhibition goals and animal requirements are often more pronounced in the large amphibian or aquatic mammals than in their terrestrial counterparts. No wonder then that most of our ecologically valid information on marine-mammal reproduction stems from field work rather than from laboratory experimentation.

The major shortcomings of marine-mammal facilities which interfere with successful reproduction are: inadequate nutrition and social structures; too small culture enclosures; lack of suitable pupping (calving) areas (size, construction, temperature control); and danger of infection of the newly born due to micro-organisms—sometimes of human origin and hence of high resistance to antibodies and antibiotics. Especially in some pelagic holo-aquatic forms, such as dolphins and porpoises, the small culture enclosures present problems to the newly born. In many cases, their mothers seem to experience considerable difficulties in preventing them from colliding with the tank walls. Presumably, the orientation mechanisms of juveniles are at first primarily adjusted to maintaining visual, auditory and mechanical contact with their mother rather than to avoiding obstacles. Injuries due to tank-wall collisions, improper breathing (poor nasal-closure timing), water intake and coughing may lead—in combination with clouds of faeces produced by the mother and other nearby adults and microbial water pollution—to dangerous, infectious diseases. Numerous captivity-born dolphins seem to have died from microbial infection. DUDOK VAN HEEL (1974b), for example, reports the death of a young *Tursiops truncatus* born in his dolphinarium due to pneumonia in both lungs with *Staphylococcus* sp. and *Escherichia coli*; post-mortem inspection revealed pieces of faeces in the inflamed lungs. According to HARRISON (personal communication), premature and still births are the most common causes of death. HARRISON considers stress an important factor inhibiting ovulation and claims, that, in his experience,

'attention is too often fixed on the food-bearing attendant than on the opposite sex.'

Reproductive parameters of some pinnipeds. n.i.: no

Species	Mating and implantation	Pupping period	Body length at birth (cm)*	Lactation period
Otariidae				
<i>Arctocephalus pusillus</i>	Mating: Summer (?) Impl.: delayed for 4-5 months	Nov., Dec.	n.i.	Up to 1 year
<i>Callorhinus ursinus</i>	Impl.: delayed for 3-5 months	June, July	n.i.	3-4 months
<i>Otaria byronia</i>	Impl.: delayed presumably for several months	Dec., Jan.	n.i.	5-6 months or longer
Odobenidae				
<i>Odobenus rosmarus</i>	Impl.: probably not delayed	April, May	100-105	13-16 months or longer
Phocidae				
<i>Cystophora cristata</i>	Impl.: delayed for up to 5 months	March, April	90-110	10-12 days
<i>Erignathus barbatus</i>	Impl.: delayed for 2-3 months	May, June	90	2-3 weeks
<i>Halichoerus grypus</i>	Impl.: delayed for 3-4 months	Sept., Oct., Nov., Dec.: (Jan.: North Sea, Febr.: Baltic Sea)	60-100	3 weeks
<i>Hydrurga leptonyx</i>	Mating: Jan. to March No implantation delay recorded	Nov., Dec.	n.i.	ca 2 weeks
<i>Leptonychotes weddelli</i>	Mating: Oct. to Dec. (Jan.) Impl.: delayed for ca 2 months	Aug. to Nov.	120	7 weeks
<i>Lobodon carcinophagus</i>	Mating: Dec. Implantation delayed for ca 2 months	Sept. to Nov.	n.i.	3-5 weeks
<i>Mirounga angustirostris</i>	No data available	Dec., Jan.	n.i.	n.i.
<i>M. leonina</i>	Mating: Sept. to Dec. Impl.: delayed for up to 3 or 4 months	Sept. to Nov.	n.i.	3 weeks

5-136

information available (Compiled from the sources indicated)

Attainment of sexual maturity	Remarks	Author
Females: 2nd year Males: later	Gestation period: 7 months; postpartum oestrus with ovulation 6 days after pupping	RAND (1955), HARRISON and KOOYMAN (1968)
Females: 3rd to 4th year Males: 4th to 5th year	Gestation period: 8-9 months; ovulation: 4-7 days after pupping, during short but obvious oestrus	ENDERS and co-authors (1946), PEARSON and ENDERS (1951), BARTHOLOMEW and HOEL (1953), KENYON and co-authors (1954), PETERSON (1968)
Females: 4th year Males: 5th year	Ovulation: a few days after pupping, probably spontaneous	HAMILTON (1934, 1939b)
Females: 5th to 6th year Males: 6th to 8th year	Gestation period: ca 12 (13) months	CHAPSEKII (1936), MOHR (1952), FAY (1957), MANSFIELD (1958a)
3rd year	Ovulation: immediately after end of lactation	MOHR (1952), RASMUSSEN (1957), ØRITSLAND (1964)
6th-7th year	Ovulation: 2 or 3 weeks after pupping	SLEPTSOV (1943), MOHR (1952), McLAREN (1958a)
Females: 5th year Males: 6th year	Ovulation: 14-16 days after pupping	MOHR (1952), HEWER (1957, 1960, 1964), COULSON and HICKLING (1964), SMITH (1964), AMOROSO and co- authors (1965)
3rd year	Possibly several ovulations at short intervals	HAMILTON (1939a), PAULIAN (1960)
3rd year	—	WILSON (1907), LINDSEY (1937), BERTRAM (1940), HARRISON and co-authors (1952), MANSFIELD (1958b)
2nd to 3rd year	—	BERTRAM (1940), MOHR (1952), LAWS (1958)
n.i.	—	BARTHOLOMEW (1952)
Females: 3rd to 6th year Males: 4th to 7th year	Oestrus during latter part of lactation period	MATTHEWS (1929), LAWS (1956a, b), GIBNEY (1957), CARRICK and INGHAM (1960), CARRICK and co-authors (1962), ULMER (1962)

Table 5-136—

Species	Mating and implantation	Pupping period	Body length at birth (cm)*	Lactation period
<i>M. leonina</i> (captive)	Spring to summer	Spring	n.i.	n.i.
<i>Pagophilus groenlandicus</i>	Impl.: delayed for ca 3 months	Jan. to early April	n.i.	12 days
<i>Phoca groenlandica</i>	Impl.: presumably delayed for 3–4 months	Febr. to May	60–95	n.i.
<i>P. vitulina</i>	Mating: late summer Impl.: delayed for 2–3 months	May to July	80–90	4–6 weeks
<i>Pusa hispida</i>	Impl.: delayed for 3–4 months	March to May	60–80	Up to 2 months

* Data compiled by MOHR (1952).

In addition, successful reproduction of captive pinnipeds and odontocetes often seems to suffer from inadequate social structures (e.g. too small population, too many males, too few females) and from insufficient age or physiological condition of parental individuals. DE HAAN (personal communication to DUDOK VAN HEEL, 1974b), for example, obtained successful breeding in his group of 22 *Phoca vitulina* only after he had established a group of mature males of various ages, including subadults, all competing with each other for the females. In a captive one-male-several-female group of *P. vitulina*, stillborns were obtained with the male 4½ years old; at 8½ years and later, numerous mostly successful births have been recorded (A. HOLTSMANN, personal communication). In odontocetes such as *Globicephala melaena* and *Tursiops truncatus*, it is assumed that the male must be at least 12 to 15 years old for successful mating (SERGEANT, 1962; SLIJPER, 1962; CALDWELL and CALDWELL, 1972; DUDOK VAN HEEL, 1974b).

Pinnipeds

Reproduction in pinnipeds is characterized by marked polygamy, sexual dimorphism and male dominance (e.g. BERTRAM, 1940; BARTHOLOMEW, 1952, 1970; PETERSON and BARTHOLOMEW, 1967; KAUFMAN and co-authors, 1975; ODELL, 1975; STIRLING, 1975; VAZ-FERREIRA, 1975). All pinnipeds are born in a state of precocious development; several forms can swim on the tide following their birth; all others learn to swim and dive—with the assistance of their mother—within the first few weeks of their life (e.g. HARRISON and KOOYMAN, 1968).

Some important reproductive parameters of pinnipeds are listed in Table 5-136. Implantation (attachment of embryo to uterine wall) is delayed in all pinnipeds

Continued

Attainment of sexual maturity	Remarks	Author
n.i.	Gestation period: ca 8-9 months	NEUGEBAUER (1967)
Females: 6th year Males: 8th year	Ovulation within 2 weeks after pupping	SIVERTSEN (1941) SERGEANT (1966)
Presumably 7th to 9th year	n.i.	MOHR (1952)
Females: 5th-6th year Males: 7th year	Gestation period: 8-9 months; ovulation in spring, can presumably be spontaneous	HAVINGA (1933), MOHR (1952), FISHER (1954), VENABLES and VENABLES (1957, 1959), HARRISON (1960, 1963, 1968), AMOROSO and co-authors (1965)
7th-8th year	Ovulation: within 2 weeks after pupping	SLEPTSOV (1943), MOHR (1952), MCLAREN (1958b)

examined, with the possible exception of the walrus *Odobenus rosmarus*. The mechanism which controls the time of implantation, apparently with high precision, has yet to be determined. In general, mating takes place during the lactation period, towards its end, or after lactation (HARRISON and KOOYMAN, 1968). Hence, hormonal dynamics which effect the oestrus (state of sexual excitability during which the male is accepted and the female capable of conceiving) do not seem to be directly related to lactation. The biological significance of implantation delay is seen in the accommodation of the pupping period to a specific season advantageous to pupping and pup development. It allows, at the same time, to restrict mating to a short period related to parturition (birth), temporal social grouping and subsequent separation of group members and of the sexes. Pinniped copulation often occurs soon (a few days or weeks) after parturition; it is performed in water, on land or on ice (e.g. MOHR, 1952; BARTHOLOMEW and HOEL, 1953; RAND, 1955; LAWS, 1956a, b; HEWER, 1957; VENABLES and VENABLES, 1957).

Callorhinus ursinus bulls can mate at intervals of about 1 hr for periods of up to several weeks (BARTHOLOMEW and HOEL, 1953); in *Mirounga angustirostris*, CARRICK and co-authors (1962) observed 6 successful copulations within 1½ hrs. Captive *M. leonina* bulls often mated several times per day (NEUGEBAUER, 1967). In wild *C. ursinus* females (Pribilof Islands), the average pregnancy rate is 0.0% at the age of 3 years, 2.9 at 4 years, 32.9 at 5, 68.7 at 6, 79.6 at 7, 85.6 at 8, 88.6 at 9 and 89.6 at 10; in older females it decreases again to about 81.7 (ICHIHARA, 1972).

Parturition usually occurs in spring and summer (KING, 1964); however, there are exceptions to this rule, e.g. in *Monachus schauinslandi*, *Halichoerus grypus* and *Mirounga angustirostris*. In most cases, parturition takes only minutes, sometimes an hour or two (SIVERTSEN, 1941; SLIJPER, 1956; CARRICK and co-authors,

1962). Birth may be delayed due to disturbance such as human presence, e.g. in *Mirounga leonina* (LAWS, 1956a) and *Phoca vitulina* (TICKELL, 1970). According to LAWS (1956a, b) and CARRICK and co-authors, cow behaviour during delivery varies from placid docility to hysteria.

Sex ratio at birth is nearly 50:50. In a *Pagophilus groenlandicus* population, 53% males were counted (SIVERTSEN, 1941); in 1000 *Callorhinus ursinus* pups, 50.5% turned out to be males (KENYON and co-authors, 1954); in 4629 *Mirounga leonina* pups, 54.9% were males (LAWS, 1956b). In *Halichoerus grypus*, the first born pups were predominantly males, the later born pups predominantly females (HEWER, 1957; COULSON and HICKLING, 1964).

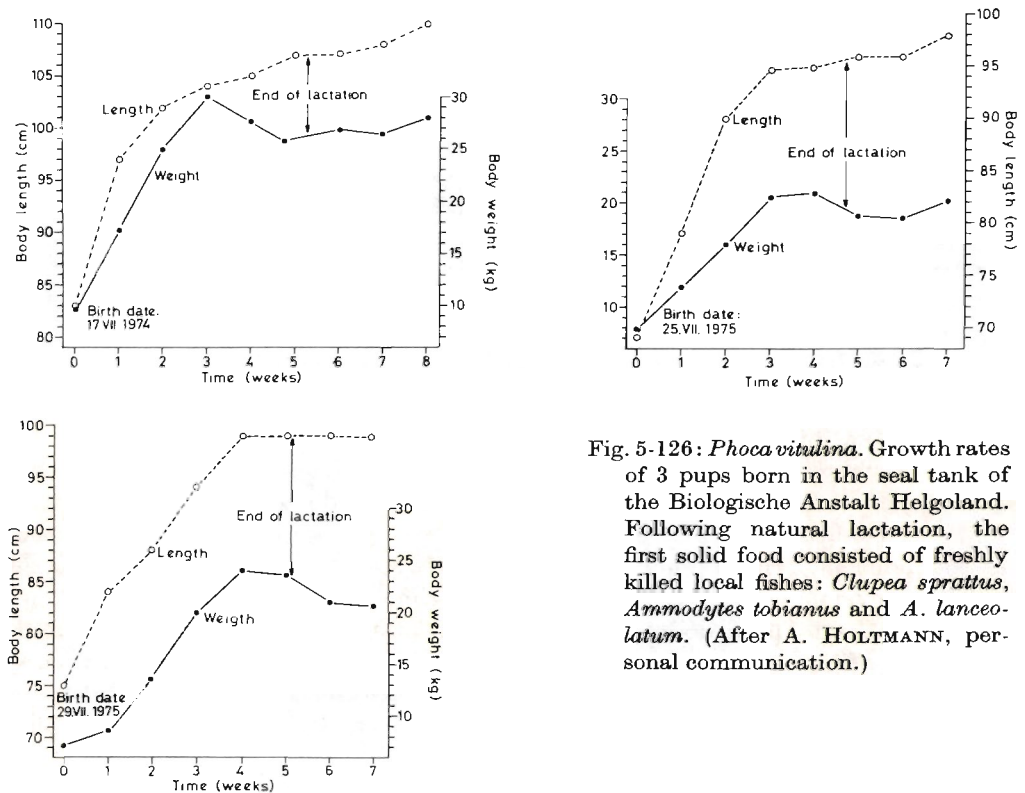

Fig. 5-126: *Phoca vitulina*. Growth rates of 3 pups born in the seal tank of the Biologische Anstalt Helgoland. Following natural lactation, the first solid food consisted of freshly killed local fishes: *Clupea sprattus*, *Ammodytes tobianus* and *A. lanceolatum*. (After A. HOLTSMANN, personal communication.)

Apparently rare, twins were born to a captive *Zalophus californianus* in Tokuyama Zoo, Japan (UCHIYAMA, 1965). The twins (a female which died after 18 days and a surviving male) appeared to be slightly smaller than the normal single sea-lion pup. In rookeries of *Z. californianus*, high premature birth rates have been observed since 1968. While the reasons for premature pupping are complex, elevated levels of polychlorinated biphenyls and DDT compounds seem to play a role (DELONG and co-authors, 1973), as well as leptospirosis (VEDROS and co-authors, 1971) and mercury-selenium-bromine imbalance (MARTIN and co-authors, 1976; see also Volume V).

In the public aquarium of the Biologische Anstalt Helgoland (FRG), 8 *Phoca*

vitulina have been born over a period of 9 years (2 stillborn, 6 still alive at this writing). Birth weights and growth rates of 3 of the pups are illustrated in Fig. 5-126. For further details on pinniped birth consult HARRISON and co-editors (1968) and NISHIWAKI (1972).

Odontocetes

The reproductive behaviour of odontocetes has been described and discussed, for example, by McBRIDE and HEBB (1948), BROWN and NORRIS (1956), TAVOLGA and ESSAPIAN (1957), BROWN (1962), FISHER and HARRISON (1970), CALDWELL and CALDWELL (1972) and RIDGWAY (1972a). This section is restricted to some aspects immediately pertinent to cultivation.

While TAVOLGA and ESSAPIAN assume the male of *Tursiops truncatus* to play the dominant role during courtship, other authors (e.g. BROWN and NORRIS; BROWN) have observed the female (*Globicephala melaena*, *Lagenorhynchus obliquidens*) to be more active. Apparently, many odontocetes display a wide range of sexual behaviour and pronounced individual differences.

RIDGWAY (1972b) assumes that the female *Tursiops truncatus* is sexually poly-oestrus and that it reaches the peak of oestrus in spring or autumn (or both). He recorded oestrus periods of roughly 36 hrs. Females which do not breed in spring probably come into oestrus again in autumn. Most females appear to calve every 2 years. As in other cetaceans, the breeding of odontocetes seems to be influenced by annual variations in day length and perhaps water temperature (Volume II: KINNE, 1975). RIDGWAY reports a great augmentation in mucus production and an increase in the number of bacteria in vaginal smears of captive *T. truncatus*. However, the increase in bacterial numbers could also have been due to the high level of bacteria in the tank water and thus would not necessarily seem to be a feature of oestrus in wild females.

Different oestrus stages of *Delphinus delphis* females have been distinguished by SOKOLOV (1961) on the basis of vaginal-smear analysis. SOKOLOV examined 114 wild individuals. The vaginal smear of immature females turned out to contain mostly medium-sized epithelial cells with well-developed nuclear structures. Mature females with ripe ovaries had medium-sized cells, often with pyknotic nuclei, as well as large, flat cells. Females in early pregnancy revealed predominantly medium-sized epithelial cells, many with pyknotic nuclei, as well as leucocytes, large flat cells and numerous horny scales. Lactating females featured small and medium-sized cells with large nuclei which had a clearly visible structure; leucocytes were numerous; towards the end of lactation, medium-sized cells dominated.

For the males of most marine mammals, the breeding season seems to be a crucial test allowing only the fittest to survive (RIDGWAY, 1972b). Fights between competing males, reduced food uptake, increased exposure to infection and high physical and physiological performance add up to a critical stress situation and to high natural mortality.

(h) Mammalia: Conclusions

In spite of the often less-than-adequate captivity conditions provided, cultivation has allowed insights into the biology and ecology of pinnipeds and odontocetes

which have added substantially to our originally very limited knowledge on these large predators of the sea. Far from being complete, the amount of information produced on environmental and nutritional requirements and on reproductive behaviour is nevertheless impressive. Cultivated marine mammals have facilitated important research on diving, growth, a variety of physiological, biochemical and medical problems, and on orientation (Volume II: KINNE, 1975). The information obtained has also been of considerable importance for increasing man's capability to work in the sea.

Kept mainly in zoos, circuses, dolphinariums, oceanaria or marinelands, the major purpose for sustaining marine mammals in captivity has been to attract and to please the paying public. This purpose has often influenced, if not dominated, architectural and technical considerations, culture-water treatment, feeding schedules, training programmes—in short all major aspects of marine-mammal cultivation. In fact, the activities of several marine-mammal-keeping facilities may be classified as commercial cultivation rather than as research cultivation (see p. 7).

Ecological research has often been tolerated rather than promoted and has largely remained restricted to conditions compatible with money making. Most of the few facilities devoted primarily to research are young, suffer from insufficient financial support, or are operated by military agencies, primarily interested in animal functions and structures exploitable for 'defence' purposes. As in many other marine animals, the production of ecologically essential data, necessary for assessing the mammals' physiological and ecological potentials (pp. 8–9) and their role in a marine ecosystem has been sadly neglected. There is considerable need for defining the mammals' environmental, nutritional and water-quality requirements in ecological terms.

A comparison between longevity data obtained on captive marine mammals and estimated *in situ* life spans indicates that our present ability for sustaining marine mammals under controlled conditions is still rather unsatisfactory. Some exhibitions have accepted survival spans as short as several months as long as these were compensated for by sufficient capital returns during that time. It was considered easier and cheaper to catch new animals than to improve the culture conditions. However, where shows are offered, minimum survival spans of 10 to 18 months become imperative, since 6 to 12 months may be necessary for achieving a complex, 'polished' training performance.

Of particular importance for successful marine mammal cultivation are culture-enclosure design (p. 1063, p. 1067), culture-water quality (p. 1069) and diet (p. 1082). Since most captive marine mammals are sustained on dead prey animals, the latter must be caught, processed and stored (at -30° to -35° C) in such a way as to minimize quality changes. Where appreciable changes in the original food composition (e.g. amino acids, vitamins) cannot be completely avoided, suitable dietary supplementation becomes a must. Where decompositional formation of toxins and other detrimental substances has occurred beyond a critical level, the food must be discarded.

When introduced to captivity, marine mammals are suddenly confronted with a large variety of new conditions which they must adjust to. They encounter, for

example, much higher densities of microbial organisms than in their natural environments and must defend themselves against dangerous, highly resistant pathogens of human origin. A closer study of the stress syndromes associated with captivity, of pathogen micro-organisms and of the mammals' response to antibiotic treatment would help to develop techniques which could assist newly captured mammals to adjust more smoothly to captivity and hence could presumably reduce the present death toll.

In contrast to most other marine animals sustained in culture, the personality of the cultivator plays a significant role for communicating with and caring for captive mammals. Culture enclosure and associated facilities must be kept clean and the addition of foreign substances avoided or carefully controlled. Attendants should wear rubber gloves and shoes to protect themselves as well as the mammals. Infectious diseases affecting attendants include the so-called 'blubber fingers' or 'fish-handler's disease'—an erysipeloid condition usually beginning as a reddened swelling of a finger; it may become quite painful and necessitates immediate medical attention.

Some perspectives repeatedly discussed in context with marine mammal cultivation deserve criticism, for example: (i) commercial *in situ* cultivation (mariculture) of mysticetes; (ii) herding of mysticetes by odontocetes trained as 'sheep dogs'; (iii) proposals to sustain marine mammals in captivity when the man-made pollution of their natural habitats annihilates their natural stocks. It seems very unlikely that *in situ* mysticete mariculture can be economical and compete with controlled hunting or other branches of mariculture and agriculture; the difficulties of such an enterprise would be considerable. The herding of mysticetes by trained odontocetes, such as *Orcinus orca*, seems impracticable to say the least in the light of modern techniques for whale finding (aeroplane, satellite), hunting and capturing. In fact, it is not the finding, hunting and capturing of mysticetes which constitute problems, but their effective protection from overexploitation. Finally: should we fail to protect our oceans from becoming polluted to such an extent that they can no longer support marine mammals, does it not sound schizophrenic to emphasize the need for programmes which would sustain a few representatives in captivity? Have any of the pseudo-protectionists involved ever ventured to visualize the world-wide ecological consequences of critically polluted oceans?

Acknowledgements. I greatly acknowledge criticism and assistance from the following colleagues: Protozoa—Drs. M. R. DROOP, M. ELBRÄCHTER, K. GOLD, D. M. LILLY, R. RÖTTGER, A. T. SOLDI, G. UHLIG; Porifera—Dr. H. MERGNER; Cnidaria—Dr. B. WERNER; Turbellaria—Dr. G. APELT; Nematoda—Drs. S. GERLACH, B. E. HOPPER, S. P. MEYERS, D. G. MURPHY, R. RIEMANN; Bryozoa—Drs. D. JEBRAM, N. R. MENON; Annelida—Drs. K. KLÖCKNER, F. KRÜGER; Crustacea—Drs. H. BARNES, D. J. CRISP, P. JATZKE, M. M. MULLIN, G.-A. PAFENHÖFER, G. PERSOONE, P. SORGELOOS, A. VENKATARAMIAH, G. WALKER, E. J. ZILLOUX; Pisces—Drs. J. H. S. BLAXTER, G. KREFFT, H. ROSENTHAL, K. TIEWS, H. VON WESTERNHAGEN; Mammalia—Drs. S. ANDERSEN, W. H. DUDOK VAN HEEL, R. EDEL, R. J. HARRISON, V. J. A. MANTON, G. PILLERI, D. SIEBERS. I am also most grateful to M. BLAKE and H. WITT, without whose help it would not have been possible to write this chapter, as well as to M. BARTEL, V. CLARK, S. HOGREVE, A. LORENZ, J. MARSCHALL, H. L. NICHOLS AND I. SCHRITT.

Literature Cited (Chapter 5.1)

- ABDERHALDEN, E. (Ed.) (1933). *Handbuch der biologischen Arbeitsmethoden*. Vol. I. Methoden der Meerwasserbiologie. Urban & Schwarzenberg, Berlin.
- ABE, N. (1937). Post-larval development of the coral *Fungia actiniformis* var. *palawensis* DODERLEIN. *Palao trop. biol. Stn Stud.*, **1**, 73-93.
- ACKMAN, R. G., EATON, C. A. and MITCHELL, E. D. (1971). The bottle-nosed dolphin *Tursiops truncatus*: fatty acid composition of milk triglycerids. *Can. J. Biochem.*, **49**, 1172-1174.
- ADACHI, R. (1964a). Studies on the culture of rotifer *Lecane tenuiseta* HARRING. II. Organic nutrition. (Jap.) *J. Fac. Fish. pref. Univ. MieTsu*, **6**, 193-202.
- ADACHI, R. (1964b). Studies on the culture of rotifer *Lecane tenuiseta* HARRING. III. Environmental factors upon the growth of *Lecane*. (Jap.) *J. Fac. Fish. pref. Univ. MieTsu*, **6**, 203-210.
- ADACHI, R. (1966). Artificial culture of fresh water rotifers. *Inf. Bull. Planktol. Japan*, **13**, 76-82.
- ADAMS, C. A. (1972). Food habits of juvenile finfish (*Lagodon rhomboides*), silver perch (*Bairdiella chrysura*), and spotted seatrout (*Cynoscion nebulosus*) of the estuarine zone near Crystal River, Florida. M.S. Thesis, University Florida.
- ADAMS, J. A. and STEELE, J. H. (1966). Shipboard experiments on the feeding of *Calanus finmarchicus* (GUNNERUS). In H. Barnes (Ed.), *Some Contemporary Studies in Marine Science*. Allen and Unwin, London. pp. 19-35.
- ADRON, J. W., BLAIR, A. and COWEY, C. B. (1974). Rearing of plaice (*Pleuronectes platessa*) larvae to metamorphosis using an artificial diet. *Fish. Bull. U.S.*, **72**, 353-357.
- AFINOWI, M. A. (1975). The biology of *Anadara senilis* and *Gryphaea (Crassostrea) gasar* in west African waters. *FAO/CIFA Symposium on Aquaculture in Africa*. Accra, Ghana. CIFA/75/SE.17, 1-20.
- AI, T. (1965). Spawning and early development of the topshell, *Turbo cornutus* SOLANDER. II. Introduction of spawning and larval development. (Jap.) *Bull. Jap. Soc. scient. Fish.*, **31**, 105-111.
- AIZAWA, Y. (1968). Ecological studies on the meso- and bathypelagic shrimps in the north-western Pacific Ocean. (Jap.) Ph.D. Thesis, University of Tokyo.
- AIZAWA, Y. (1969). Vertical distribution and migration of meso- and bathypelagic shrimps in the neighbouring Sea of Japan. (Jap.) *Bull. Plankton Soc. Japan*, **16**, 60-63.
- ÅKESSON, B. (1967). On the biology and larval morphology of *Ophryotrocha puerilis* CLAP. METSCH. (Polychaeta). *Ophelia*, **4**, 110-119.
- ÅKESSON, B. (1970). *Ophryotrocha labronica* as test animal for the study of marine pollution. *Helgoländer wiss. Meeresunters.*, **20**, 293-303.
- ÅKESSON, B. (1976). Morphology and life cycle of *Ophryotrocha diadema*, a new polychaete species from California. *Ophelia*, **15**, 23-25.
- AKIMUSHKIN, I. I. (1954a). The basic diet in *Hyperoodon rostratus* MÜLLER. (Russ.) *Dokl. Akad. Nauk SSSR*, **95**, 419-420.
- AKIMUSHKIN, I. I. (1954b). Cephalopods in sperm whale diet. (Russ.) *Dokl. Akad. Nauk SSSR*, **96**, 665-667.
- AKIMUSHKIN, I. I. (1955). On sperm whale feeding. (Russ.) *Dokl. Akad. Nauk SSSR*, **101**, 1139-1140.
- ALBERTINI-BERHAUT, J. (1974). Biologie des stades juveniles de Teleosteens Mugilidae *Mugil auratus* RISSO 1810, *Mugil capito* CUVIER 1829 et *Mugil saliens* RISSO 1810. II. Modifications du regime alimentaire en relation avec la taille. *Aquaculture*, **4**, 13-27.
- ALBRECHT, M.-L. and BREITSPRECHER, B. (1969). Untersuchungen über die chemische Zusammensetzung von Fischnährtieren und Fischfuttermitteln. *Z. Fisch.*, **17**, 143-163.
- ALCOCK, A. (1893). An account of the collection of deep-sea Asteroidea. Natural History notes from H. M. Indian Marine Survey Steamer 'Investigator'. *Ann. Mag. nat. Hist.* (Ser. 6), **11**, 73-121.

- ALDERDICE, D. F. and VELSEN, F. P. J. (1968). Design of a controlled-environment incubator for small marine fish eggs. *J. Fish. Res. Bd Can.*, **25**, 585-588.
- ALDERDICE, D. F., WICKETT, W. P. and BRETT, G. R. (1958). Some effects of temporary exposure to low dissolved oxygen level on Pacific salmon eggs. *J. Fish. Res. Bd Can.*, **15**, 229-249.
- ALLEMAND, A. (1906). Étude de physiologie appliquée à la spongiculture sur les côtes de Tunisie. (Unpublished manuscript.)
- ALLEN, E. J. and NELSON, E. W. (1910). On the artificial culture of marine plankton organisms. *J. mar. biol. Ass. U.K.*, **8**, 421-474.
- ALVING, T. (1939). Aufzucht und Pflege von Walrossen. *Zool. Garten, Lpz.*, **10**, 215-218.
- AMANO, K. and YAMADO, K. (1965). The biological formation of formaldehyde in cod flesh. In R. Kreuzer (Ed.), *The Technology of Fish Utilization*. Fishing News (Books) Ltd., Surrey. pp. 73-78.
- AMBACHE, N. and SAWAYA, P. (1953). Use of *Holothuria grisea* for acetylcholine assays of electric-organ extracts from *Narcine brasiliensis* (OLFERS). *Physiologia comp. Oecol.*, **3**, 53-56.
- AMOROSO, E. C., BOURNE, G. H., HARRISON, R. J., MATTHEWS, L. H., ROWLANDS, I. W. and SLOPER, J. C. (1965). Reproductive and endocrine organs in foetal, neonatal, and adult seals. *J. Zool., Lond.*, **147**, 430-486.
- AMOROSO, E. C. and MATTHEWS, L. H. (1952). Reproduction and lactation in the seal. *Congr. int. Physiol. Path. Réprod. anim.*, **2**, 193-203.
- AMUNDIN, M. (1974). Occupational therapy for harbour porpoises, *Phocoena phocoena*. *Aquatic Mammals*, **2**, 6-11.
- ANDERSEN, H. T. (Ed.) (1969). *The Biology of Marine Mammals*, Academic Press, New York.
- ANDERSEN, S. H. (1965). L'Alimentation du marsouin (*Phocoena phocoena* L.) en captivité. *Vie Milieu*, **16**, 799-810.
- ANDERSEN, S. H. (1976). The taming and training of the harbor porpoise *Phocoena phocoena*. *Cetology*, **24**, 1-9.
- ANDERSEN, S. H. (1973). Treatment of water in dolphinaria. *Aquatic Mammals*, **1**, 1-18.
- ANDERSEN, S. H. (1974a). A typical case history of the net-caught harbour porpoise, *Phocoena phocoena*, from Danish waters. *Aquatic Mammals*, **2**, 1-6.
- ANDERSEN, S. H. (1974b). The rearing of suckling harbour porpoises (*Phocoena phocoena*). *Aquatic Mammals*, **2**, 23-27.
- ANDERSEN, S. H. and DIEDZIC, A. (1964). Behaviour patterns of captive harbour porpoise *Phocoena phocoena* (L.). *Bull. Inst. océanogr. Monaco*, **63**, 1-20.
- ANDERSON, E. D. and SMITH, L. L., JR. (1971). An automatic brine shrimp feeder. *Progve Fish Cult.*, **33**, 118-119.
- ANDERSON, J. M. (1959). Studies on the cardiac stomach of a starfish, *Patiria miniata* (BRANDT). *Biol. Bull. mar. biol. Lab., Woods Hole*, **117**, 185-201.
- ANDERSON, J. M. (1960). Histological studies on the digestive system of a starfish, *Henricia*, with notes on Tiedemann's pouches in starfishes. *Biol. Bull. mar. biol. Lab., Woods Hole*, **119**, 371-398.
- ANDERSON, J. M. (1962). Pyloric caeca and Tiedemann's pouches in *Linckia columbiae*. *Am. Zool.*, **2**, 387.
- ANDERSON, J. M. (1966). Aspects of nutritional physiology. In R. A. Boolootian (Ed.), *Physiology of Echinodermata*. Interscience Publ., New York. pp. 329-357.
- ANDREWS, J. W. and PAGE, J. W. (1975). The effects of frequency of feeding on culture of catfish. *Trans. Am. Fish. Soc.*, **104**, 317-321.
- ANDREWS, J. W., SICK, L. V. and BAPTIST, G. J. (1972). The influence of dietary protein and energy levels on growth and survival of penaeid shrimp. *Aquaculture*, **1**, 341-347.
- ANEMIYA, I. (1962). The dolphin that swallowed a football. *Int. Zoo Yb.*, **4**, 34-35.
- ANONYMOUS (1971). Eels spawn artificially. *Comm. Fish. Rev.*, **33**, 53.
- ANONYMOUS (1973a). Capsulation techniques, development of diets for larval and postlarval aquatic animals reported. *Feedstuffs, Lond.*, **45**, 35.
- ANONYMOUS (1973b). South Africa-oceanarium. British Overseas Trade Board. *Export Intelligence Announcement*, **202**.

- ANRAKU, M. (1964a). Some technical problems encountered in quantitative studies of grazing and predation by marine planktonic copepods. *J. oceanogr. Soc. Japan*, **20**, 221-231.
- ANRAKU, M. (1964b). Influence of the Cape Cod Canal on the hydrography and on the copepods in Buzzards Bay and Cape Cod Bay, Massachusetts. II. Respiration and feeding. *Limnol. Oceanogr.*, **9**, 195-206.
- ANRAKU, M. (1973). Continuous culture systems of zooplankton. *Bull. Plankton Soc. Japan*, **20**, 12-18.
- AOE, H., MASUDA, I., ABE, I., SAITO, T., TOYODA, T. and KITAMURA, S. (1970). Nutrition of protein in young carp. I. Nutritive value of free amino acids. *Bull. Jap. Soc. scient. Fish.*, **36**, 407-413.
- APELT, G. (1969). Fortpflanzungsbiologie, Entwicklungszyklen und vergleichende Frühentwicklung acoeler Turbellarien. *Mar. Biol.*, **4**, 267-325.
- APPELLÖF, A. (1901). Studien über Actinien-Entwicklung. *Bergens Mus. Åarb.*, **1901**, 1-99.
- APPLEGATE, V. C. (1950). Natural history of the sea lamprey (*Petromyzon marinus*) in Michigan. *Spec. scient. Rep. U.S. Fish Wildl. Serv., Fisheries*, **55**, 1-237.
- ARAI, S., NOSE, T. and KAWATSU, H. (1975). Effect of minerals supplemented to the fish meal diet on growth of eel, *Anguilla japonica*. *Bull. Freshwat. Fish. Res. Lab., Tokyo*, **24**, 95-100.
- ARANA, M. F. (1974). Experiences in the culture of crayfish *Macrobrachium americanum* BATE in northwestern Mexico. *FAO/CARPAS Symposium on Aquaculture in Latin America*. Montevideo, Uruguay. CARPAS 6/74/SE.19, 1-9.
- ARNDT, A. (1922). Zur Technik der Amöbenzüchtung. *Zentbl. Bakt. ParasitKde (Abt. 1)*, **21**, 417-422.
- ARNDT, E. A. and FELBER, F. (1971). Über den Einfluß des Salzgehaltes auf den Sauerstoffverbrauch von *Cordylophora caspia* PALLAS (Hydrozoa, Athecata). *Wiss. Z. Univ. Rostock, Reihe Mathematik und Naturwissenschaften*, Heft 1, 19-32.
- ARNDT, W. (1930). Schwämme, Porifera, Spongien. In C. Oppenheimer and L. Pincussen (Eds), *Tabulae Biologicae*, Vol. VI. Junk, Berlin. pp. 39-120.
- ARNDT, W. (1933). Haltung und Aufzucht von Meeresschwämmen. In E. Abderhalden (Ed.), *Handbuch der biologischen Arbeitsmethoden*, Vol. I, Methoden der Meeresbiologie. Urban & Schwarzenberg, Berlin. pp. 443-464.
- ARNOLD, Z. M. (1954a). *Discorinopsis aguayoi* (BERMUDEZ) and *Discorinopsis vadescens* CUSHMANN and BRONNIMANN. A study of variation in cultures of living Foraminifera. *Contr. Cushman Fdn. foramin. Res.*, **5**, 4-13.
- ARNOLD, Z. M. (1954b). Culture methods in the study of living Foraminifera. *J. Paleontol.*, **28**, 404-416.
- ARNOLD, Z. M. (1955). Life history and cytology of the foraminiferan *Allogromia laticollaris*. *Univ. Calif. Publ. Zool.*, **61**, 167-252.
- ARNOLD, Z. M. (1966). A laboratory system for maintaining small volume cultures of Foraminifera and other organisms. *Micropaleontology*, **12**, 109-118.
- ARSENIJEV, V. A. (1941). Food of the ribbon seal (*Histiophoca fasciata*). *Izv. tikhookean. nauchnoissled. Inst. rjyb. Khoz. Okeanogr.*, **20**, 121-127.
- ARTHUR, D. K. (1956). The particulate food and the food resources of the larvae of three pelagic fishes, especially the Pacific sardine, *Sardinops caerulea* (GIRARD). Ph.D. Thesis, University of California.
- ARVY, L. (1973-1974). Mammary glands, milk and lactation in cetaceans. In G. Pilleri (Ed.), *Investigations on Cetacea*, Vol. V. Prof. G. Pilleri, Waldau-Berne. pp. 157-202.
- ASHLEY, L. M. (1972). Nutritional Pathology. In J. E. Halver (Ed.), *Fish Nutrition*. Academic Press, New York. pp. 439-537.
- ASHWORTH, U. S., RAMAIAH, G. D. and KEYES, M. C. (1966). Species difference in the composition of milk with special reference to the Northern fur seal. *J. Dairy Sci.*, **49**, 1206-1211.
- ASPER, E. D. (1975). Techniques of live capture of smaller Cetacea. *J. Fish. Res. Bd Can.*, **32**, 1191-1196.
- ATEMA, J. and ENGSTROM, D. G. (1972). Sex pheromone in the lobster, *Homarus americanus*. *Nature, Lond.*, **232**, 261-263.
- ATKINSON, C., HOPLEY, S., MENDELSON, L. and YACOWITZ, S. (1973). In *West Indies Laboratory, St. Croix, Spec. Publ.*, **2**, 65-80. (Quoted in LAWRENCE, 1975.)

- ATODA, K. (1947). The larval and postlarval development of some reef-building corals. I. *Pocillopora damicornis cespitosa* (DANA). *Scient. Rep., Tohoku Univ.* (Series 4, Biology), **18**, 24-47.
- ATODA, K. (1951a). The larval and postlarval development of reef-building corals. III. *Acropora bruggemanni* (BROOK). *J. Morph.*, **89**, 1-16.
- ATODA, K. (1951b). The larval and postlarval development of reef-building corals. IV. *Galaxea aspera* (QUELCH). *J. Morph.*, **89**, 17-36.
- ATZ, J. W. (1953). Orientation in schooling fishes. In *Proceedings of the Conference on Orientation in Animals*, 1953. (Quoted in RADA KOV, 1972.)
- ATZ, J. W. (1961). Raising Ookie. *Anim. Kingd.*, **64**, 13-22.
- ATZ, J. W. (1964). A working bibliography on rearing larval marine fishes in the laboratory. In J. R. Clark and R. L. Clark (Eds), *Sea-water Systems for Experimental Aquariums*. A Collection of Papers. *Res. Rep. U.S. Fish. Wildl. Serv.*, **63**, 95-102.
- ATZ, J. W. and PICKFORD, G. E. (1959). The use of pituitary hormones in fish-culture. *Endeavour*, **18**, 125-129.
- AUBERT, M. (1971). Télémédiateurs chimiques et équilibre biologique océanique. Première partie: Théorie général. *Rev. int. Oceanogr. méd.*, **21**, 5-16.
- AUGUSTIN, A. and ANGER, K. (1974). Experimente über Substratpräferenzen von *Capitella capitata* (FABRICIUS). *Kieler Meeresforsch.*, **30**, 28-36.
- AUSTIN, W. (1964). The feeding mechanism and digestive system in *Ophiothrix spiculata* and *Ophiura lütkeni* (Ophiuroidea, Echinodermata). Ph.D. Thesis, Stanford University.
- AYLING, A. M. (1976). The strategy of orientation in the barnacle *Balanus trigonus*. *Mar. Biol.*, **36**, 335-342.
- AYMES, Y. (1956). Croissance phototropique chez les Bryozoaires du genre *Bugula*. *C.r. hebd. Séanc. Acad. Sci., Paris*, **242**, 1237-1238.
- BAAB, J. S., HAMM, G. L., HAINES, K. C., CHU, A. and ROELS, O. A. (1973). Shellfish mariculture in an artificial upwelling system. *Proc. natn. Shellfish. Ass.*, **63**, 63-67.
- BAAS BECKING, L. G. M., KARSTENS, W. K. H. and KANNER, M. (1936). Salzeffekte und Milieu bei *Artemia salina* L. nebst Bemerkungen über Ionen-antagonismus. *Protoplasma*, **25**, 32-40.
- BABENKO, V. V., GNITETSKY, N. A. and KOZLOV, L. F. (1970). Preliminary results of investigations of temperature distribution on dolphin body surface. (Russ.) *Bionica*, **4**, 83-87.
- BACCI, G. (1951a). Existence of true males and females in a hermaphrodite population of *Ophryotrocha puerilis*. *Experientia*, **7**, 222-224.
- BACCI, G. (1951b). Amputazione e successione delle fasi sessuali di *Ophryotrocha puerilis*. *Boll. Soc. ital. Biol. sper.*, **28**, 778-782.
- BACCI, G. (1951c). Effeti di ripetute amputazioni sulle fasu sessuali di *Ophryotrocha puerilis*. *Boll. Zool.*, **19**, 193.
- BACCI, G. (1955). La variabilita dei genotipi sessuali negli animali ermafroditi. *Pubbl. Staz. zool. Napoli*, **26**, 110-137.
- BACCI, G. (1965). *Sex Determination*, Pergamon Press, Oxford.
- BACCI, G. and BORTESI, O. (1960). Conferma della variabilita dei genotipi sessuali nel polichete ermafroditi *Ophryotrocha puerilis siberti*. *Rc. Accad. naz. XL*, **28**, 92-94.
- BACCI, G. and BORTESI, O. (1961a). Existence of multiple sex genotypes in the hermaphrodite polychaete worm *Ophryotrocha puerilis siberti*. *Nature, Lond.*, **191**, 838.
- BACCI, G. and BORTESI, O. (1961b). Pure males and females from hermaphroditic strains of *Ophryotrocha puerilis*. *Experientia*, **17**, 229-230.
- BACKHOUSE, K. M. (1961). Locomotion of seals with particular reference to the forelimb. *Symp. zool. Soc. Lond.*, **5**, 59-75.
- BACQ, Z. M. (1939). Un test marin pour l'acétylcholine. *Archs int. Physiol.*, **49**, 20-24.
- BAE, G. M. (1973). Studies on suspended culture of oyster *Crassostrea gigas* in the Korean coastal waters. II. On the growth rate of oyster by four regional growing areas. *Bull. Fish. Res. Dev. Agency, Pusan*, **11**, 59-69.
- BAHAMONDE, N. and HENRIQUEZ, G. (1970). Sinopsis de datos biológicos sobre el camaron nailon *Heterocarpus reedi* BAHAMONDE, 1955. *F.A.O. Fish. Rep.*, **57**, 1607-1627.

- BAILEY, R. E. (1965). Training and open ocean release of an Atlantic bottlenose porpoise, *Tursiops truncatus* (MONTAGU), China Lake, California. *Naval Ordnance Test Station, Tech. Pap.*, **3838**, 1.
- BAKER, A. DE. C. (1963). The problem of keeping planktonic animals alive in the laboratory. *J. mar. biol. Ass. U.K.*, **43**, 291-294.
- BALAZS, G. H. (1973). Preliminary studies on the preparation and feeding of crustacean diets. *Aquaculture*, **2**, 369-377.
- BANG, K. S. (1970). Experiment in the production of the young bori prawn *Penaeus japonicus* BATE. (Korean; Engl. summary.) *Bull. Fish. Res. Dev. Agency, Pusan*, **5**, 53-61.
- BANK, O. (1967). Keine Rückstände in den Muskeln von Karpfen nach Dauerverfütterung antibiotikahaltigen Trockenfutters (Carp). *Fischwirt*, **17**, 11-13.
- BARDACH, J. E., RYTHER, J. H. and McLARNEY, W. O. (1972). *Aquaculture*. Wiley, New York.
- BARKER, H. A. (1935). The culture and physiology of marine dinoflagellates. *Arch. Mikrobiol.*, **6**, 157-181.
- BARNABÉ, G. (1974). Mass rearing of the bass *Dicentrarchus labrax* L. In J. H. S. Blaxter (Ed.), *The Early Life History of Fish*. Springer-Verlag, Berlin. pp. 749-753.
- BARNES, E. W. (1905). Lobster culture in 1905. *36th Ann. Rep. Rhode Isl. Commnr inld Fish.*, **1905**, 111-119.
- BARNES, H. (1955). The growth rate of *Chthamalus stellatus* (POLI). *J. mar. biol. Ass. U.K.*, **35**, 355-361.
- BARNES, H. (1957). Processes of restoration and synchronization in marine ecology. The spring diatom increase and the spawning of the common barnacle, *Balanus balanoides*. *Année biol.*, **33**, 67-85.
- BARNES, H. (1959). Temperature and life-cycle of *Balanus balanoides*. In D. L. Ray (Ed.), *Marine Boring and Fouling Organisms*. University Washington Press, Seattle. pp. 234-245.
- BARNES, H. (1963). Light, temperature and the breeding of *Balanus balanoides*. *J. mar. biol. Ass. U.K.*, **43**, 717-727.
- BARNES, H. and BARNES, M. (1954). The general biology of *Balanus balanus* L. DA COSTA. *Oikos*, **5**, 63-76.
- BARNES, H. and BARNES, M. (1958). The rate of development of *Balanus balanoides* (L.) larvae. *Limnol. Oceanogr.*, **3**, 29-32.
- BARNES, H. and BARNES, M. (1967). The effect of starvation and feeding on the time of production of egg masses in the boreo-arctic cirripede, *Balanus balanoides* (L.). *J. exp. mar. Biol. Ecol.*, **1**, 1-6.
- BARNES, H. and BARNES, M. (1974). The responses during development of the embryos of some common cirripedes to wide changes in salinity. *J. exp. mar. Biol. Ecol.*, **15**, 197-202.
- BARNES, H. and POWELL, H. T. (1953). The growth of *Balanus balanoides* (L.) and *Balanus crenatus* BRUG. under varying conditions of submersion. *J. mar. biol. Ass. U.K.*, **32**, 107-128.
- BARNES, H. and STANBURY, F. A. (1948). The toxic action of copper and mercury salts both separately and when mixed on the harpacticoid copepod, *Nitocra spinipes* (BOECK). *J. exp. Biol.*, **25**, 270-275.
- BARNES, H. and STONE, R. L. (1972). Suppression of penis development in *Balanus balanoides* (L.). *J. exp. mar. biol. Ecol.*, **9**, 303-309.
- BARNES, H. and STONE, R. L. (1974). The effect of food, temperature, and light-period (day-length) on moulting frequency in *Balanus balanoides* (L.). *J. exp. mar. Biol. Ecol.*, **15**, 275-284.
- BARNES, R. D. (1963). *Invertebrate Zoology*, Saunders, Philadelphia.
- BARR, M. W. (1969). Culturing the marine harpacticoid copepod, *Tisbe furcata* (BAIRD, 1837). *Crustaceana*, **16**, 95-96.
- BARTHOLOMEW, G. A. (1952). Reproductive and social behavior of the Northern elephant seal. *Univ. Calif. Publ. Zool.*, **47**, 369-472.
- BARTHOLOMEW, G. A., JR. (1954). Body temperature and respiratory and heart rates in the northern elephant seal. *J. Mammal.*, **35**, 211-219.

- BARTHOLOMEW, G. A. (1970). A model for the evolution of pinniped polygyny. *Evolution, Lancaster, Pa.*, **24**, 546-559.
- BARTHOLOMEW, G. A. and HOEL, P. G. (1953). Reproductive behavior of the Alaska fur seal, *Callorhinus ursinus*. *J. Mammal.*, **34**, 417-436.
- BARTHOLOMEW, G. A., JR., and WILKE, F. (1956). Body temperature in the northern fur seal, *Callorhinus ursinus*. *J. Mammal.*, **37**, 327-337.
- BARTMANN, W. (1974). Some remarks on the behaviour and handling of white whales (*Delphinapterus leucas*) in captivity. *Aquatic Mammals*, **2**, 16-21.
- BASSINDALE, R. (1936). The developmental stages of three English barnacles, *Balanus balanoides*, *Chthamalus stellatus* and *Verruca stroemia*. *Proc. zool. Soc. Lond.*, **1**, 57-74.
- BATHAM, E. J. (1945). *Pollicipes spinosus* QUOY and GAIMARD. II. Embryonic and larval development. *Trans. R. Soc. New Zealand*, **75**, 405-418.
- BATTAGLIA, B. (1959a). Il polimorfismo adattativo e i fattori della selezione nel Copepode *Tisbe reticulata* BOCQUET. *Archo Oceanogr. Limnol.*, **11**, 19-69.
- BATTAGLIA, B. (1959b). Facteur thermique et différenciation saisonnière chez un copépode harpacticocide de la Lagune de Venise. *Vie Milieu*, **10**, 1-13.
- BATTAGLIA, B. (1970). Cultivation of marine copepods for genetic and evolutionary research. *Helgoländer wiss. Meeresunters.*, **20**, 385-392.
- BATTAGLIA, B. and FAVA, G. (1968). Prime osservazioni sulla genetica di popolazioni naturali e sperimentali di *Tisbe clodiensis* n. sp. (Copepoda, Harpacticoida). *Riv. Biol.*, **21**, 1-33.
- BATTAGLIA, B. and FINCO, G. (1969). Fattori biotici e selezione naturale in Copepodi del genere *Tisbe*. *Atti Ist. veneto Sci. Scienze mat. e nat.*, **127**, 363-370.
- BATTAGLIA, B. and VOLKMAN-ROCCO, B. (1969). Gradienti di isolamento riproduttivo in popolazioni geografiche del copepode *Tisbe clodiensis*. *Atti Ist. veneto Sci. Scienze mat. e nat.*, **127**, 371-381.
- BAUGHMAN, J. L. (1948). *An Annotated Bibliography of Oysters, with Pertinent Material on Mussels and other Shellfish and an Appendix on Pollution*, Texas A. & M. Res. Found., College Station, Texas.
- BAYNE, B. L. (1969). The gregarious behavior of the larvae of *Ostrea edulis* L. at settlement. *J. mar. biol. Ass. U.K.*, **49**, 327-356.
- BAYNE, B. L. and THOMPSON, R. J. (1970). Some physiological consequences of keeping *Mytilus edulis* in the laboratory. *Helgoländer wiss. Meeresunters.*, **20**, 526-552.
- BAZIRE, M. (1953). Cultures pures d'*Hydatina senta*: premiers résultats. *C.r. hebd. Séanc. Acad. Sci., Paris*, **236**, 855-857.
- BEATTY, R. A. (1964). Gynogenesis in vertebrates: fertilization by genetically inactivated spermatozoa. In W. D. Carlson and F. X. Gassner (Eds), *Effects of Ionizing Radiation on the Reproductive System*. Pergamon Press, Oxford. pp. 229-241.
- BEAUCHAMP, M. P. (1910). Sur l'existence et les conditions de la parthénogenèse chez *Dinophilus*. *C.r. hebd. Séanc. Acad. Sci., Paris*, **150**, 739-741.
- BEAUCHAMP, M. P. (1912). Contribution à l'étude expérimentale de la sexualité chez *Dinophilus*. *C.r. hebd. Séanc. Acad. Sci., Paris*, **154**, 1836-1838.
- BEAUCHAMP, P. DE (1928). Coup d'oeil sur les recherches récentes relatives aux rotifères et sur les méthodes qui leur sont applicables. *Bull. biol. Fr. Belg.*, **62**, 51-125.
- BEAUCHAMP, P. DE (1938). Les cultures de rotifères sur chlorelles. Premiers résultats en milieu septique. *Trav. Stn zool. Wimereux*, **13**, 27-38.
- BECHER, S. (1906). Über *Synapta minuta* n. sp., eine Brutpflegende Synaptide der Nordsee, und über die contractilen Rosetten der Holothurien. *Zool. Anz.*, **30**, 505-509.
- BEDFORD, F. P. (1900). On echinoderms from Singapore and Malacca. *Proc. zool. Soc. Lond.*, **1900**, 271-299.
- BEER, G. R. DE and HUXLEY, J. S. (1924). Studies in dedifferentiation. 5. Dedifferentiation and reduction in *Aurelia*. *Q. Jl microsc. Sci.*, **68**, 471-479.
- BEKLEMISHEV, K. V. (1950). Nutrition of *Nereis pelagica* and the functional importance of its buccal apparatus. (Russ.) *Dokl. Akad. Nauk. SSSR*, **73**, 1093-1095.
- BEKLEMISHEV, K. V. (1953). Biology of feeding in some nereids. (Russ.) *Trudj vses. gidrobiol. Obsch.*, **5**, 283-298.
- BELAR, K. (1928). Untersuchung der Protozoen. In T. Péterfi (Ed.), *Methodik der wissenschaftlichen Biologie*, Bd. I. Springer-Verlag, Berlin. pp. 735-826.

- BELLAN, G., CARUELLE, F., FORET-MONTARDO, P., KAIM-MALKA, R. A. and LEUNG TACK, K. (1969). Contribution à l'étude de différents facteurs physiochimiques polluants sur les organismes marins. I. Action des détergents sur la polychète *Scolelepis fuliginosa* (note préliminaire). *Téthys*, **1**, 367-374.
- BELLAN, G., REISH, D. J. and FORET, J.-P. (1971). Action toxique d'un détergent sur le cycle de développement de la polychète *Capitella capitata* (FAB.). *C.r. hebd. Séanc. Acad. Sci., Paris*, **272**, 2476-2479.
- BELLAN, G., REISH, D. J. and FORET, J.-P. (1972). The sublethal effects of a detergent on the reproduction, development, and settlement in the polychaetous annelid *Capitella capitata*. *Mar. Biol.*, **14**, 183-188.
- BENCHLEY, F. J. (1930). Experiences with elephant seal. *Parks and Recreation*, **13**, 317-320.
- BENIJTS, F., VANVOORDE, E. and SORGELOOS, P. (in press). Changes in biochemical composition between the first larval stages of the brine shrimp *Artemia salina*. In G. Persoone and E. Jaspers (Eds), *Tenth European Marine Biology Symposium*. Ostend, Belgium, 1975.
- BENNETT, E. W. (1927). Notes on some New Zealand seastars and on autotomous reproduction. *Rec. Canterbury Mus.*, **3**, 125-149.
- BENOIT, D., SYRETT, R. and HALE, J. (1969). Automatic live brine shrimp feeder. *Trans. Am. Fish. Soc.*, **98**, 532-533.
- BENOIT, P. (1925). L'ovogenèse et le premier stade du développement chez la Myriothele et chez la Tubularie. *Archs Zool. exp. gén.*, **64**, 85-326.
- BEN-TUVIA, A., KISSIL, G. W. and POPPER, D. (1973). Experiments in rearing rabbitfishes (*Siganus rivulatus*) in sea water. *Aquaculture*, **1**, 359-364.
- BERGH, W. VAN DEN (1970). The delphinarium at Antwerp Zoo. *Int. Zoo Yb.*, **10**, 45-47.
- BERGQUIST, P. R. and SINCLAIR, M. E. (1968). The morphology and behaviour of larvae of some intertidal sponges. *N.Z. Jl mar. freshwat. Res.*, **2**, 426-437.
- BERGQUIST, P. R., SINCLAIR, M. E. and HOGG, J. J. (1970). Adaptations to intertidal existence: reproductive cycles and larval behaviour in Demospongiae. In W. G. Fry (Ed.), *The Biology of Porifera*. (Symp. Zool. Soc. London, **25**, 246-271.)
- BERNARD, M. (1963). Le cycle vital en laboratoire d'un copépode pélagique de Méditerranée *Euterpina acutifrons* CLAUS. *Pelagos*, **1**, 35-48.
- BERNHARD, M. (1955). Die Kultur von Seeigellarven (*Arbacia lixula* L.) in künstlichem und natürlichem Meerwasser mit Hilfe von Ionenaustauschsubstanzen und Komplexbildnern. *Pubbl. Staz. zool. Napoli*, **29**, 80-95.
- BERRILL, N. J. (1948a). A new method of reproduction in *Obelia*. *Biol. Bull. mar. biol. Lab., Woods Hole*, **95**, 94-99.
- BERRILL, N. J. (1948b). Temperature and size in the reorganization of *Tubularia*. *J. exp. Zool.*, **107**, 455-464.
- BERRILL, N. J. (1949a). Polymorphic transformations in *Obelia*. *Q. Jl microsc. Sci.*, **90**, 235-264.
- BERRILL, N. J. (1949b). Growth and form in gymnoblastic hydroids. I. Polymorphic development in *Bougainvillia* and *Aselomaris*. *J. Morph.*, **84**, 1-30.
- BERRILL, N. J. (1949c). Growth and form in calyptoblastic hydroids. I. Comparison of a campanulid, *Campanularia*, *Sertularia*, and *Plumularia*. *J. Morph.*, **85**, 297-335.
- BERRILL, N. J. (1950). Growth and form in calyptoblastic hydroids. II. Polymorphism within the Campanularidae. *J. Morph.*, **87**, 1-26.
- BERRILL, N. J. (1952). Growth and form in gymnoblastic hydroids. II. Sexual and asexual reproduction in *Rathkea*. III. Hydranth and gonophore development in *Pennaria* and *Acaulis*. IV. Relative growth in *Eudendrium*. *J. Morph.*, **90**, 1-32.
- BERRILL, N. J. (1953a). Growth and form in gymnoblastic hydroids. VI. Polymorphism within the Hydractiniidae. *J. Morph.*, **92**, 241-272.
- BERRILL, N. J. (1953b). Growth and form in gymnoblastic hydroids. VII. Growth and reproduction in *Syncoryne* and *Coryne*. *J. Morph.*, **92**, 273-302.
- BERRILL, N. J. (1961). *Growth, Development and Pattern*, W. H. Freeman & Co., San Francisco.
- BERTRAM, G. C. L. (1940). The biology of the Weddell and crabeater seals with a study of the comparative behavior of the Pinnipedia. *Scient. Rep. Br. Graham Id Exped.*, **1**, 1-139.
- BETOUHIM-EL, T. and KAHAN, D. (1972). *Tisbe pori* n. sp. (Copepoda: Harpacticoida) from the Mediterranean coast of Israel and its cultivation in the laboratory. *Mar. Biol.*, **16**, 201-209.

- BEUTLER, R. (1925). Beobachtungen an gefütterten Hydroidpolypen. *Z. vergl. Physiol.*, **3**, 737-775.
- BHATTACHARYYA, R. N. (1957). The food and feeding habits of larval and post-larval herring in the northern North Sea. *Mar. Res.*, **3**, 1-14.
- BICK, H. (1964). *Die Sukzession der Organismen bei der Selbstreinigung von organisch verunreinigtem Wasser unter verschiedenen Milieubedingungen*, Der Minister für Ernährung, Landwirtschaft und Forsten des Landes Nordrhein-Westfalen, Düsseldorf.
- BICK, H. (1972). *Ciliated Protozoa*, World Health Organization, Geneva.
- BICK, H. and BERTRAM, R. (1973). *Experimentell-ökologische Untersuchung der Populationsdynamik von Aufwuchsciliaten unter besonderer Berücksichtigung des Temperaturfaktors*, Forschungsberichte des Landes Nordrhein-Westfalen, Westdeutscher Verlag, Opladen.
- BICK, H. and KUNZE, S. (1971). Eine Zusammenstellung von autökologischen und saprobiologischen Befunden an Süßwasserciliaten. *Int. Revue ges. Hydrobiol.*, **3**, 337-384.
- BIDDER, H. P. (1923). The relation of the form of a sponge to its currents. *Q. Jl microsc. Sci.*, **67**, 293-323.
- BIERBACH, M. and HOFMANN, D. K. (1973). Experimentelle Untersuchungen zum Stockwachstum und zur Medusenbildung bei dem marinen Hydrozoon *Eirene viridula*. *Helgoländer wiss. Meeresunters.*, **25**, 63-84.
- BIGG, M. A. and WOLMAN, A. A. (1975). Live-capture killer whale (*Orcinus orca*) fishery, British Columbia and Washington, 1962-73. *J. Fish. Res. Bd Can.*, **32**, 1213-1221.
- BIRKY, C. W. (1964). Studies on the physiology and genetics of the rotifer *Asplanchna*. I. *J. exp. Zool.*, **155**, 273-292.
- BIRKY, C. W. (1969). The developmental genetics of polymorphism in the rotifer *Asplanchna*. III. *J. exp. Zool.*, **170**, 437-488.
- BIRKY, C. W. and GILBERT, J. J. (1971). Parthenogenesis in rotifers. The control of sexual and asexual reproduction. *Am. Zool.*, **11**, 245-266.
- BISHAI, H. M. (1961). Rearing fish larvae. *Bull. zool. Soc. Egypt*, **16**, 4-29.
- BLAXTER, J. H. S. (1953). Sperm storage and cross-fertilization of spring and autumn spawning herring. *Nature, Lond.*, **172**, 1190.
- BLAXTER, J. H. S. (1955). Herring rearing. I. The storage of herring gametes. *Mar. Res.*, **1955**, 1-12.
- BLAXTER, J. H. S. (1962). Herring rearing. IV. Rearing beyond the yolk-sac stage. *Mar. Res.*, **1962**, 1-18.
- BLAXTER, J. H. S. (1965). The feeding of herring larvae and their ecology in relation to feeding. *Rep. Calif. coop. oceanic Fish. Invest.*, **10**, 79-88.
- BLAXTER, J. H. S. (1966). The effect of light intensity on the feeding ecology of herring. In R. Bainbridge, G. C. Evans and O. Rackham (Eds), *Light as an Ecological Factor*. (Br. Ecol. Soc. Symp. 6.) pp. 393-409.
- BLAXTER, J. H. S. (1968). Rearing herring larvae to metamorphosis and beyond. *J. mar. biol. Ass. U.K.*, **48**, 17-28.
- BLAXTER, J. H. S. (1969a). Experimental rearing of pilchard larvae, *Sardina pilchardus*. *J. mar. biol. Ass. U.K.*, **49**, 557-575.
- BLAXTER, J. H. S. (1969b). Development: eggs and larvae. In W. S. Hoar and D. J. Randall (Eds), *Fish Physiology*, Vol. III. Academic Press, New York. pp. 177-252.
- BLAXTER, J. H. S. (1970a). Light: Animals. Fishes. In O. Kinne (Ed.), *Marine Ecology*, Vol. I. Environmental Factors, Part 1. Wiley, London. pp. 213-285.
- BLAXTER, J. H. S. (1970b). Sensory deprivation and sensory input in rearing experiments. *Helgoländer wiss. Meeresunters.*, **20**, 642-654.
- BLAXTER, J. H. S. (in press). Rearing and wild fish—how do they compare? In G. Persoone and E. Jaspers (Eds), *Tenth European Marine Biology Symposium*. Ostend, Belgium, 1975.
- BLAXTER, J. H. S. and EHRlich, K. F. (1974). Changes in behaviour during starvation of herring and plaice larvae. In J. H. S. Blaxter (Ed.), *The Early Life History of Fish*. Springer-Verlag, Berlin. pp. 575-588.
- BLAXTER, J. H. S. and HEMPEL, G. (1961a). Biologische Beobachtungen bei der Aufzucht von Heringsbrut. *Helgoländer wiss. Meeresunters.*, **7**, 260-283.
- BLAXTER, J. H. S. and HEMPEL, G. (1961b). Rearing experiments on herring larvae. *Naturwissenschaften*, **48**, 81-82.

- BLAXTER, J. H. S. and HEMPEL, G. (1963). The influence of egg size on herring larvae (*Clupea harengus* L.). *Rapp. P.-v. Réun. Cons. perm. int. Explor. Mer*, **28**, 211-240.
- BLAXTER, J. H. S. and HOLLIDAY, F. G. T. (1958). Herring (*Clupea harengus* L.) in aquaria. II. Feeding. *Mar. Res.*, **6**, 1-22.
- BLAXTER, J. H. S., ROBERTS, R. J., BALBONTIN, F. and MCQUEEN, A. (1974). B-group vitamin deficiency in cultured herring. *Aquaculture*, **3**, 387-394.
- BLAXTER, J. H. S. and STAINES, M. E. (1971). Food searching potential in marine fish larvae. In D. J. Crisp (Ed.), *Fourth European Marine Biology Symposium*. University Press, Cambridge. pp. 467-485.
- BLEGVAD, H. (1914). Food and conditions of nourishment among the communities of invertebrate animals found on or in the sea bottom in Danish waters. *Rep. Dan. biol. Stn*, **22**, 41-78.
- BLOUNT, R. F. (1937). Cultivation of *Enchytraeus albidus*. In J. G. Needham (Ed.), *Culture Methods for Invertebrate Animals*. Comstock Publishing Co., New York. pp. 191-192.
- BOAS, J. E. V. (1886). *Spolia Atlantica*. Bidrag til Pteropodernes. Morfologi og Systematik samt til Kundskaben om deres geografiske Udbredelse. *K. danske Vidensk. Selsk. Skr. (Raekke, naturv. mat. Afd.)*, **4**, 1-231.
- BOCQUET, C. (1951). Recherches sur *Tisbe* (= *Idyaea*) *reticulata* n. sp. Essai d'analyse génétique du polychromatisme d'un Copépode Harpacticoides. *Archs Zool. exp. gén.*, **87**, 335-416.
- BOGOMOLOVA, E. M., SAAKYAN, S. A. and KAZAROVITSKII, L. M. (1958). *Imitative Conditioned Reflexes in Fish*. Izdatel'stvo AN SSSR, Moscow.
- BOGUCKI, M. (1953). *Nereis diversicolor* (O.F.M.), ecological notice. (Pol.; Engl. summary.) *Polskie Arch. Hydrobiol.*, **1**, 79-87.
- BOGUCKI, M. (1954). The reproduction and the development of *Nereis diversicolor* (O. F. MÜLLER) in the Baltic. (Pol.; Engl. summary.) *Polskie Arch. Hydrobiol.*, **2**, 251-270.
- BOGUCKI, M. (1962). Rearing *Nereis diversicolor* O. F. MÜLLER in laboratory conditions. (Pol.; Engl. summary.) *Przeegl. zool.*, **6**, 232-234.
- BOND, R. M. (1937a). A method for rearing *Artemia salina*. In J. G. Needham (Ed.), *Culture Methods for Invertebrate Animals*. Comstock Publishing Co., New York. pp. 205-206.
- BOND, R. M. (1937b). Notes on the cultivation of *Tigriopus fulvus* and *Calanus finmarchicus*. In J. G. Needham (Ed.), *Culture Methods for Invertebrate Animals*. Comstock Publishing Co., New York. pp. 224-226.
- BONNOT, P. (1928). Report on the seals and sea lions of California. *Fish Bull. Calif.*, **14**, 1-61.
- BOOKHOUT, C. G. and COSTLOW, J. D., JR. (1970). Nutritional effects of *Artemia* from different locations on larval development of crabs. *Helgoländer wiss. Meeresunters.*, **20**, 435-442.
- BOOLOOTIAN, R. A. (Ed.) (1966a). *Physiology of Echinodermata*, Interscience Publishers, New York.
- BOOLOOTIAN, R. A. (1966b). Reproductive physiology. In R. A. Boolootian (Ed.), *Physiology of Echinodermata*. Interscience Publishers, New York. pp. 561-613.
- BOONE, E. and BAAS BECKING, L. G. M. (1931). Salt effects on eggs and nauplii of *Artemia salina* L. *J. gen. Physiol.*, **14**, 753-763.
- BORJA, P. C. and RASALAN, S. B. (1957). A review of the culture of Sugo *Penaeus monodon* FABRICIUS, in the Philippines. *F.A.O. Fish. Rep.*, **57**, 111-124.
- BOROJEVIC, R. (1966). Étude expérimentale de la différenciation des cellules de l'éponge au cours de son développement. *Devl Biol.*, **14**, 130-153.
- BOSCHMA, H. (1923). Kopulation bei einer Asteroide. *Zool. Anz.*, **58**, 283-285.
- BOSCHMA, H. (1929). On the postlarval development of the coral *Meandrea areolate* (L.). *Publs Carnegie Instn*, **391**, 131-147.
- BOTSFORD, L. W., RAUCH, H. E. and SHLESER, R. A. (1974). Optimal temperature control of a lobster plant. *IEEE Trans. autom. contr.*, **AC 19**, 541-543.
- BOUGIS, P. (1971). Effect of the temperature sur le développement endotrophe des pluteus. In D. J. Crisp (Ed.), *Fourth European Marine Biology Symposium*. University Press, Cambridge. pp. 197-201.
- BOVERI, T. (1889). Ein geschlechtlich erzeugter Organismus ohne mütterliche Eigenschaften. *Sber. Ges. Morph. Physiol. Münch.*, **5**, 73.

- BOVERI, T. (1901a). Die Polarität von Oocyten, Ei und Larve des *Strongylocentrotus lividus*. *Zool. Jb. (Anat. Ontogenie Tiere)*, **14**, 630-653.
- BOVERI, T. (1901b). Über die Polarität des Seeigeleies. *Verh. phys.-med. Ges. Würzb.*, **34**, 145-175.
- BOVERI, T. (1902). Über mehrpolige Mitosen als Mittel zur Analyse des Zellkernes. *Verh. phys.-med. Ges. Würzb.*, **35**, 67.
- BOVERI, T. (1908). Zellenstudien VI. Die Entwicklung dispermer Seeigeleier. Ein Beitrag zur Befruchtungslehre und zur Theorie des Kernes. *Jena. Z. Naturw.*, **43**, 1.
- BOWBEER, A. (1971). The underwater lobster farm. *Wild Fishg.*, **20**, 36-37.
- BOYD, J. (1974). A simple, rapid method for collecting pan hatched brine shrimp. *Progve Fish Cult.*, **36**, 57.
- BOYDEN, C. R., WATLING, H. and THORNTON, I. (1975). Effect of zinc on the settlement of the oyster *Crassostrea gigas*. *Mar. Biol.*, **31**, 227-234.
- BOYER, B. C. (1971). Regulative development in a spiralian embryo as shown by cell deletion experiments on the acoel, *Chilidia*. *J. exp. Zool.*, **176**, 97-106.
- BRADSHAW, J. S. (1955). Preliminary laboratory experiments on ecology of foraminiferal populations. *Micropaleontology*, **1**, 351-358.
- BRADSHAW, J. S. (1957). Laboratory studies on the rate of growth of the foraminifer, *Streblus beccarii* (LINNE) var. *tepida* (CUSHMAN). *J. Paleont.*, **31**, 1138-1147.
- BRADSHAW, J. S. (1961). Laboratory experiments on the ecology of Foraminifera. *Contr. Cushman Fdn foramin. Res.*, **12**, 87-106.
- BRAEKKAN, O. R. (1962). B-vitamins in fish and shell-fish. In E. Heen and R. Kreuzer (Eds), *Fish Nutrition*. Fishing News (Books) Ltd., Surrey. pp. 132-140.
- BRAEM, F. (1951). Über *Victorella* und einige ihrer nächsten Verwandten sowie über die Bryozoenfauna des Ryck bei Greifswald. *Zoologica*, **102**, 1-59.
- BRAND, T. VON (1927). Stoffbestand und Ernährung einiger Polychaeten und anderer mariner Würmer. *Z. vergl. Physiol.*, **5**, 643-698.
- BRANDL, Z. (1973). Laboratory culture of cyclopoid copepods on a definite food. *Věstn. Cesk. Spol. Zool.*, **37**, 81-88.
- BRANHAM, J. M. (1973). The crown of thorns on coral reefs. *BioScience*, **23**, 219-226.
- BRAUER, R. M. and JORDAN, M. R. (1970). Triggering of the stomach eversion reflex of *Acanthaster planci* by coral extracts. *Nature, Lond.*, **228**, 344.
- BRAUM, E. (1967). The survival of fish larvae with reference to their feeding behaviour and the food supply. In S. D. Gerking (Ed.), *The Biological Basis of Freshwater Fish Production*. Wiley, New York. pp. 113-131.
- BRAVERMAN, M. H. (1962). Studies in hydroid differentiation. I. *Podocoryne carnea* culture methods and carbon dioxide induced sexuality. *Exptl Cell. Res.*, **27**, 301-306.
- BRAVERMAN, M. H. (1963). Studies on hydroid differentiation. II. Colony growth and the initiation of sexuality. *J. Embryol. exp. Morph.*, **11**, 239-253.
- BRAVERMAN, M. H. and SCHRANDT, R. (1966). Colony development of a polymorphic hydroid as a problem in pattern formation. *Symp. zool. Soc. Lond.*, **16**, 169-198.
- BRAVERMAN, M. H. and SCHRANDT, R. (1969). Studies in hydroid differentiation. V. The control of growth in young colonies of *Podocoryne carnea*. *Growth*, **33**, 241-254.
- BREDER, C. M. (1951). Studies on the structure of the fish school. *Bull. Am. Mus. nat. Hist.*, **98**, 1-25.
- BREDER, C. M. (1954). Equations descriptive of fish schools and other animal aggregations. *Ecology*, **35**, 361-370.
- BREDER, C. M. (1959). Studies on social groupings in fishes. *Bull. Am. Mus. nat. Hist.*, **117**, 399-481.
- BREDER, C. M. (1965). Vortices and fish schools. *Zoologica, N.Y.*, **50**, 97-116.
- BREDER, C. M. (1967). On the survival value of fish schools. *Zoologica, N.Y.*, **52**, 25-40.
- BREDER, C. M., JR. and ROSEN, D. E. (1966). *Modes of Reproduction in Fishes*, The Natural History Press, New York.
- BREUSE, W. P. and PHIBBS, F. D. (1969). Some observations on the spawning and early development of the butter clam, *Saxidomus giganteus* (DESHAYSR). *Proc. natn. Shellfish. Ass.*, **60**, 95-98.

- BRELAND, K. and BRELAND, M. (1968). *Animal Behavior*, Macmillan, New York.
- BRENKO, M. HRS. and CALABRESE, A. (1969). The combined effects of salinity and temperature on larvae of the mussel *Mytilus edulis*. *Mar. Biol.*, **4**, 224-226.
- BRERETON, A., LORD, H., THORNTON, I. and WEBB, J. S. (1973). Effect of zinc on growth and development of larvae of the Pacific oyster *Crassostrea gigas*. *Mar. Biol.*, **19**, 96-101.
- BRETT, J. R. (1970). Temperature: Animals. Fishes. In O. Kinne (Ed.), *Marine Ecology*, Vol. I, *Environmental Factors*, Part I. Wiley, London. pp. 515-560.
- BRETT, J. R. (1974). Tank experiments on the culture of pan-size sockeye (*Oncorhynchus nerka*) and pink salmon (*O. gorbuscha*) using environmental control. *Aquaculture*, **4**, 341-352.
- BRETT, J. R. and SHELBORNE, J. E. (1975). Growth rate of young sockeye salmon, *Oncorhynchus nerka*, in relation to fish size and ration level. *J. Fish. Res. Bd Can.*, **32**, 2103-2110.
- BRETT, J. R., SHELBORNE, J. E. and SHOOP, C. T. (1969). Growth rate and body composition of fingerling sockeye salmon, *Oncorhynchus nerka*, in relation to temperature and ration size. *J. Fish. Res. Bd Can.*, **26**, 2363-2394.
- BRETT, J. R. and SUTHERLAND, D. B. (1970). Improvement in the artificial rearing of sockeye salmon by environmental control. *J. Fish. Res. Bd Can.*, *Nanaimo Biol. Stn Circ.*, **99**, 1-14.
- BRICK, R. W. (1974). Effects of water quality, antibiotics, phytoplankton and food on survival and development of larvae of *Scylla serrata* (Crustacea: Portunidae). *Aquaculture*, **3**, 231-244.
- BRIEN, P. (1968). Porifera: the sponges, or porifera. In M. Florkin and B. T. Scheer (Eds), *Chemical Zoology*, 2. Academic Press, New York. pp. 1-30.
- BRIGHTWELL, L. R. (1949). House to house at the zoo. *Zoo Life*, **4**, 21-23.
- BRIGHTWELL, L. R. (1951). Some experiments with the common hermit crab (*Eupagurus bernhardus* L.) and transparent univalve shells. *Proc. zool. Soc. Lond.*, **121**, 279-283.
- BRINCKMANN, A. (1962). The life cycle of *Merga galleri* sp. n. *Pubbl. Staz. zool. Napoli*, **33**, 1-9.
- BRINCKMANN, A. (1964). Observations on the biology and development of *Staurocladia portmanni* sp. n. (Anthomedusae, Eleutheridae). *Can. J. Zool.*, **42**, 693-705.
- BRINCKMANN-VOSS, A. (1966). The morphology and development of *Acaulis ilonae* sp. n. (Anthomedusae/Athecata, Fam. Acaulidae). *Can. J. Zool.*, **44**, 291-301.
- BROAD, A. C. (1950). Results of shrimp research in North Carolina. *Proc. Gulf Caribb. Fish. Inst.*, **3**, unpaginated.
- BROAD, A. C. (1957a). Larval development of *Palaemonetes pugio* HOLTHUIS. *Biol. Bull. mar. biol. Lab., Woods Hole*, **112**, 144-161.
- BROAD, A. C. (1957b). The relationship between diet and larval development of *Palaemonetes*. *Biol. Bull. mar. biol. Lab., Woods Hole*, **112**, 162-170.
- BROAD, A. C. and HUBSCHMAN, J. H. (1960). The larval development of *Palaemonetes kadiakensis* RATHBUN. *Anat. Rec.*, **137**, 343-344.
- BROAD, A. C. and HUBSCHMAN, J. H. (1962). A comparison of larvae and larval development of species of Eastern U. S. *Palaemonetes* with special reference to the development of *Palaemonetes intermedius* HOLTHUIS. *Am. Zool.*, **2**, 394-395.
- BROAD, A. C. and HUBSCHMAN, J. H. (1963). The larval development of *Palaemonetes kadiakensis* M. J. RATHBUN in the laboratory. *Trans. Am. microsc. Soc.*, **82**, 185-197.
- BROCK, M. A. and STREHLER, B. L. (1963). Studies on the comparative physiology of aging. IV. Age and mortality of some marine Cnidaria in the laboratory. *J. Geront.*, **18**, 23-28.
- BROEKEMA, M. M. M. (1941). Seasonal movements and the osmotic behaviour of the shrimp, *Crangon crangon* L. *Archs néerl. Zool.*, **6**, 1-100.
- BROOKS, J. W. (1952). A preliminary progress report on Pacific walrus investigations. *Manuscript report, University of Alaska*.
- BROOKS, J. W. (1954). A contribution to the life history and ecology of the Pacific walrus. *Spec. Rep. Alaska coop. Wildl. Res. Unit*, **1**, 1-103.
- BROOKS, W. K. and HERRICK, F. H. (1892). The embryology and metamorphosis of the Macrura. *Mem. natn. Acad. Sci.*, **5**, 321-576.
- BROOM, J. G. (1969). Pond culture of shrimp on Grand Terre Island, Louisiana 1962-1968. *Proc. Gulf Caribb. Fish. Inst.*, **21**, 137-151.

- BROWN, A., JR. (1972). Experimental techniques for preserving diatoms used as food for larval *Penaeus aztecus*. *Proc. natn. Shellfish. Ass.*, **62**, 21-25.
- BROWN, C. (1973). The effects of some selected bacteria on embryos and larvae of the American oyster, *Crassostrea virginica*. *J. Invert. Pathology*, **21**, 215-223.
- BROWN, D. H. (1960). Behavior of a captive Pacific pilot whale. *J. Mammal.*, **41**, 342-349.
- BROWN, D. H. (1962). Further observations on the pilot whale in captivity. *Zoologica, N.Y.*, **47**, 59-64.
- BROWN, D. H. (1963). The health problems of walrus calves, and remarks on their general progress in captivity. *Int. Zoo Yb.*, **4**, 13-23.
- BROWN, D. H. and ASPER, E. D. (1966). Further observations on the Pacific walrus *Odobenus rosmarus divergens* in captivity. *Int. Zoo Yb.*, **6**, 78-82.
- BROWN, D. H. and NORRIS, K. S. (1956). Observations of captive and wild cetaceans. *J. Mammal.*, **37**, 311-326.
- BROWN, R. N. R. (1915). The seals of the Weddell Sea: notes on their habits and distribution. In W. S. Bruce (Ed.), *Voyage of the S.Y. "Scotia" . . . 1902, 1903, and 1904*, Vol. 4. Scottish Oceanographical Laboratory, Edinburgh. pp. 185-198.
- BROWN, W. D., VENOLIA, A. W., TAPPEL, A. L., OLCOTT, H. S. and STANSEY, M. E. (1957). Oxidative deterioration in fish and fishery products. *Comml Fish. Rev.*, **19**, 1-27.
- BROWNE, E. T. (1898). On keeping medusae alive in an aquarium. *J. mar. biol. Ass. U.K.*, **5**, 176-180.
- BROWNE, E. T. (1907). A new method for growing hydroids in small aquaria by means of continuous current tube. *J. mar. biol. Ass. U.K.*, **8**, 37-43.
- BRUUN, A. F. and WOLFF, T. (1961). Abyssal benthic organisms: nature, origin, distribution and influence on sedimentation. In M. Sears (Ed.), *Oceanography. (Amer. Ass. Adv. Sci., 67)* pp. 391-397.
- BRYAN, P. G. (1974). Food habits, functional digestive morphology, and assimilation efficiency of the rabbitfish *Siganus spinus* (Pisces: Siganidae) on Guam. M. Sci. Thesis, University of Guam.
- BRYAN, P. G. (1975). Food habits, functional digestive morphology, and assimilation efficiency of the rabbitfish *Siganus spinus* (Pisces, Siganidae) on Guam. *Pacif. Sci.*, **29**, 269-277.
- BUCHANAN, J. B. (1964). A comparative study of some features of the biology of *Amphiura filiformis* and *Amphiura chiajei* (Ophiuroidea) considered in relation to their distribution. *J. mar. biol. Ass. U.K.*, **44**, 565-576.
- BUCHNER, H. (1936). Experimentelle Untersuchungen über den Generationswechsel der Rädertiere. *Z. indukt. Abstamm.-u. Vererb. Lehre*, **72**, 1-49.
- BUCHNER, H. (1938). Vitalität und Bisexualität bei den heterogenen Rädertieren. *Revue suisse Zool.*, **45**, 395-404.
- BUCHNER, H. (1941a). Entwicklungsphysiologische Untersuchungen über den Generationswechsel der Rädertiere. I. *Wilhelm Roux' Arch. Entw.Mech. Org.*, **141**, 154-158.
- BUCHNER, H. (1941b). Experimentelle Untersuchungen über den Generationswechsel der Rädertiere. II. *Zool. Jb. (Allg. Zool. Physiol. Tiere)*, **60**, 279-344.
- BUCHNER, H. (1941c). Freilanduntersuchungen über den Generationswechsel der Rädertiere. I. *Zool. Jb. (Allg. Zool. Physiol. Tiere)*, **60**, 253-278.
- BUCHNER, H. (1971). Die Sexualität der heterogenen Rädertiere. *Naturw. Rdsch.*, **24**, 191-199.
- BUCHNER, H. and KIECHLE, H. (1965). Die Determination der heterogenen Fortpflanzungsarten bei den Rädertieren. *Naturwissenschaften*, **52**, 647.
- BUCHNER, H. and KIECHLE, H. (1966). Der Einfluß der Temperatur auf die Bisexualität von *Asplanchna*. *Naturwissenschaften*, **53**, 708.
- BUCHNER, H., KIECHLE, H. and TIEFENBACHER, L. (1969). Untersuchungen über die Bedingungen der heterogenen Fortpflanzungsarten bei den Rädertieren. I. *Zool. Jb. (Allg. Zool. Physiol. Tiere)*, **74**, 329-426.
- BUDD, P. L. (1940). Development of the eggs and larvae of six California fishes. *Calif. Fish Game, Fish Bull.*, **56**, 1-50.
- BUDDENBROCK, W. VON (1953). *Vergleichende Physiologie. II. Nervenphysiologie*, Birkhäuser, Basel.

- BÜCKMANN, A., HARDER, W. and HEMPEL, G. (1953). Unsere Beobachtungen am Hering, *Clupea harengus* L. *Kurze Mitt. fischbiol. Abt. Max-Planck-Inst. Meeresbiol. Wilhelmsh.,* **3**, 22-42.
- BUHR, K.-J. (in press). Suspension feeding and assimilation efficiency in *Lanice conchilega* (Polychaeta). *Mar. Biol.*
- BULL, H. O. (1934). Aquarium observations on the rate of growth and enemies of the common starfish *Asterias rubens*. *Rep. Dove mar. Lab.* (Ser. 3), **2**, 60-65.
- BULL, H. O. (1939). The growth of *Psammechinus miliaris* (GMELIN) under aquarium conditions. *Rep. Dove mar. Lab.* (Ser. 3), **6**, 39-41.
- BULLIVANT, J. S. (1968). The rate of feeding of the bryozoan, *Zoobotryon verticillatum*. *N.Z. J. mar. Freshwat. Res.*, **2**, 111-134.
- BURGESS, K. (1968). The behaviour and training of a killer whale *Orcinus orca* at San Diego Sea World. *Int. Zoo Yb.*, **8**, 202-205.
- BURKHOLDER, P. R. (1952). Cooperation and conflict among primitive organisms. *Am. Scient.*, **40**, 601-631.
- BURLA, H., FERLIN, V., PABST, B. and RIBI, G. (1972). Notes on the ecology of *Astropecten aranciacus*. *Mar. Biol.*, **14**, 235-241.
- BURNETT, A. L. (1960). The mechanism employed by the starfish, *Asterias forbesi*, to gain access to the interior of the bivalve, *Venus mercenaria*. *Ecology*, **41**, 583-584.
- BUTLER, T. H. (1970). Synopsis of biological data on the prawn *Pandalus platyceros* BRANDT, 1851. *F.A.O. Fish. Rep.*, **57**, 1289-1315.
- BUZNIKOV, G. A. (1957). On the physiology of the hatching glands of embryo in Teleostei. *Z. obsc. Biol.*, **18**, 350-359.
- CACES, P. B. and RASALAN, S. B. (1968). A review of the culture of sugpo, *Penaeus monodon* FABRICIUS, in the Philippines. *F.A.O. Fish. Rep.*, **57**, 111-123.
- CAIN, T. D. (1973). The combined effects of temperature and salinity on embryos and larvae of the clam *Rangia cuneata*. *Mar. Biol.*, **21**, 1-6.
- CALABRESE, A. (1969). Individual and combined effects of salinity and temperature on embryos and larvae of the coot clam, *Mulinia lateralis* (SAY). *Biol. Bull. mar. biol. Lab., Woods Hole*, **137**, 417-428.
- CALABRESE, A., COLLIER, R. S., NELSON, D. A. and MACINNES, J. R. (1973). The toxicity of heavy metals to embryos of the American oyster *Crassostrea virginica*. *Mar. Biol.*, **18**, 162-166.
- CALABRESE, A. and DAVIS, H. C. (1969). Spawning of the American oyster, *Crassostrea virginica*, at extreme pH levels. *Veliger*, **11**, 235-236.
- CALABRESE, A. and DAVIS, H. C. (1970). Tolerances and requirements of embryos and larvae of bivalve molluscs. *Helgoländer wiss. Meeresunters.*, **20**, 553-564.
- CALABRESE, A. and NELSON, D. A. (1974). Inhibition of embryonic development of the hard clam, *Mercenaria mercenaria*, by heavy metals. *Bull. environ. Contam. & Toxicol.*, **11**, 92-97.
- CALDER, D. R. (1973). Laboratory observations on the life history of *Rhopilema verrilli* (Scyphozoa: Rhizostomeae). *Mar. Biol.*, **21**, 109-114.
- CALDWELL, D. K. and CALDWELL, M. C. (Eds) (1968). *Diseases and Husbandry of Aquatic Mammals*, Proc. 2nd Symp., Fla Atl. Univ., Boca Raton, Florida.
- CALDWELL, M. C. and CALDWELL, D. K. (1966). Epimeletic (care-giving) behavior in Cetacea. In K. S. Norris (Ed.), *Whales, Dolphins, and Porpoises*. University of California Press, Berkeley. pp. 755-788.
- CALDWELL, M. C. and CALDWELL, D. K. (1969). The ugly dolphin. *Sea Front.*, **15** (5/6), unpaginated.
- CALDWELL, M. C. and CALDWELL, D. K. (1972). Behavior of marine mammals. In S. H. Ridgway (Ed.), *Mammals of the Sea*. Thomas, Springfield. pp. 419-465.
- CAMBELL, K. (1969). Fish culture in U.S. and Japan—eels, salmon and trout. *Wld Fish.*, **18**, 20-21.
- CAMERON, R. A. and HINEGARDNER, R. T. (1974). Initiation of metamorphosis in laboratory cultured sea urchins. *Biol. Bull. mar. biol. Lab., Woods Hole*, **146**, 335-342.
- CAMPBELL, R. D. (1966). Mechanisms of hydrozoan stolon elongation. *Am. Zool.*, **6**, 330.

- CAMPBELL, R. D. (1968a). Holdfast movement in the hydroid *Corymorpha palma*: Mechanism of elongation. *Biol. Bull. mar. biol. Lab., Woods Hole*, **134**, 26-34.
- CAMPBELL, R. D. (1968b). Colony growth and pattern in the two-tentacled hydroid, *Proboscoidactyla flavicirrata*. *Biol. Bull. mar. biol. Lab., Woods Hole*, **135**, 96-104.
- CANAGARATNAM, P. (1959). Growth of fishes in different salinities. *J. Fish. Res. Bd Can.*, **16**, 121-130.
- CANSDALE, G. (1970). Hand-rearing common seals *Phoca vitulina* at Skegness Natureland. *Int. Zoo Yb.*, **10**, 146-147.
- CARBINE, W. P. (1947). Bangos culture in the Philippines. *Progve Fish Cult.*, **10**, 187-197.
- CARCELLES, A. (1944). Nuevos datos sobre el contenido estomacal de 'Astropecten' Sladen. *Physis, B. Aires*, **19**, 461-472.
- CARCELLES, A. and PARODIZ, G. (1938). Moluscas del contenido estomacal de *Astropecten cingulatus*. *Physis, B. Aires*, **12**, 251-266.
- CARLISLE, J. G., JR. (1945). The technique of inducing spawning in *Haliotis rufescens* SWAINSON. *Science, N.Y.*, **102**, 566-567.
- CARLISLE, J. G., JR. (1962). Spawning and early life history of *Haliotis rufescens* SWAINSON. *Nautilus*, **76**, 44-49.
- CARLUCCI, A. F. and PRAMER, D. (1957). Factors influencing the plate method for determining abundance of bacteria in sea water. *Proc. Soc. exp. Biol. Med.*, **96**, 392-394.
- CARR, W. E. S. and ADAMS, C. A. (1973). Food habits of juvenile marine fishes occupying sea-grass beds in the estuarine zone near Crystal River, Florida. *Trans. Am. Fish. Soc.*, **102**, 511-540.
- CARRICK, R. and INGHAM, S. E. (1960). Ecological studies of the Southern elephant seal, *Mirounga leonina* (L.), at Macquarie Island and Heard Island. *Mammalia*, **24**, 325-342.
- CARRICK, R., CSORDAS, S. E. and INGHAM, S. E. (1962). Studies on the Southern elephant seal, *Mirounga leonina* (L.). IV. Breeding and development. *C.S.I.R.O. Wildl. Res.*, **7**, 161-197.
- CARRIKER, M. R. (1956). Biology and propagation of young hard clams, *Mercenaria mercenaria*. *J. Elisha Mitchell scient. Soc.*, **72**, 57-60.
- CASTAGNA, M., HAVEN, D. S. and WHITCOMB, J. B. (1969). Treatment of shell cultch with Poly-stream to increase the yield of sea oysters, *Crassostrea virginica*. *Proc. natn. Shellfish. Ass.*, **59**, 84-90.
- CASTILLA, J. C. (1971). Responses to light of *Asterias rubens* L. In D. J. Crisp (Ed.), *Fourth European Marine Biology Symposium*. University Press, Cambridge. pp. 495-511.
- CASTILLA, J. C. (1972). Avoidance behaviour of *Asterias rubens* to extracts of *Mytilus edulis*, solutions of bacteriological peptone, and selected amino acids. *Mar. Biol.*, **15**, 236-245.
- CASTILLA, J. C. and CRISP, D. J. (1970). Responses of *Asterias rubens* to olfactory stimuli. *J. mar. biol. Ass. U.K.*, **50**, 829-847.
- CASTRO, P. (1969). Symbiosis between *Echinoecus pentagonus* (Echinoidea). Ph.D. Thesis, Hawaii University.
- CAZAUX, C. (1964). Développement larvaire de *Sabellaria alveolata* (LINNÉ). *Bull. Inst. océanogr. Monaco*, **62**, 1-15.
- CHAET, A. B. (1964a). A mechanism for obtaining mature gametes from starfish. *Biol. Bull. mar. biol. Lab., Woods Hole*, **126**, 8-13.
- CHAET, A. B. (1964b). Shedding substance and 'shedhibin'—from the nerves of the starfish, *Patiria miniata*. *Am. Zool.*, **4**, 407.
- CHAET, A. B. (1964c). The shedding substance activity of starfish nerves. *Tex. Rep. Biol. Med.*, **22**, 204.
- CHAET, A. B. (1966). The gamete shedding substance(s) of sea-stars: physiological-biochemical study. *Am. Zool.*, **6**, 263-271.
- CHAET, A. B. (1967). Gamete release and shedding substance of sea-stars. *Symp. zool. Soc. Lond.*, **20**, 13-24.
- CHAET, A. B., ANDREWS, P. M. and SMITH, R. H. (1964). The shedding substance of starfish nerve—its function and micro-assay. *Fedn Proc. Fedn Am. Socs exp. Biol.*, **23**, 204.
- CHAET, A. B. and MCCONNAUGHY, R. A. (1959). Physiologic activity of nerve extracts. *Biol. Bull. mar. biol. Lab., Woods Hole*, **117**, 407-408.
- CHAET, A. B. and MUSICK, R. S., JR. (1960). A method for obtaining gametes from *Asterias forbesi*. *Biol. Bull. mar. biol. Lab., Woods Hole*, **119**, 292.

- CHAET, A. B. and ROSE, R. A. (1961). Further studies on the gamete 'shedding substance' from radial nerves. *Biol. Bull. mar. biol. Lab., Woods Hole*, **121**, 385-386.
- CHAMBERS, E. L. and CHAMBERS, R. (1949). Ion exchanges and fertilization in echinoderm eggs. *Am. Nat.*, **83**, 269-284.
- CHANG, S. L. (1958). Cultural, cytological and ecological observations on the Amoeba stage of *Naegleria gruberi*. *J. gen. Microbiol.*, **18**, 565-578.
- CHANG, T. M. S., MACINTOSH, F. C. and MASON, S. G. (1966). Semi-permeable aqueous microcapsules. I. Preparation and properties. *Can. J. Physiol. Pharmac.*, **44**, 115-123.
- CHANLEY, M. H. and TERRY, O. W. (1974). Inexpensive modular habitats for juvenile lobsters (*Homarus americanus*). *Aquaculture*, **4**, 89-92.
- CHANLEY, P. E. and NORMANDIN, R. F. (1960). Preliminary studies of preserved foods for larvae of bivalve mollusks. (Unpublished, address given at N.S.A. Convention, August 1960.)
- CHAO, L. N. (1973). Digestive system and feeding habits of the cunner, *Tautoglabrus adspersus*, a stomachless fish. *Fish Bull. Calif.*, **71**, 565-586.
- CHAPMAN, S. S. (1957). Differential responses of growth zones to nutritive level, age and temperature in the colonial hydroid *Campanularia*. *J. exp. Zool.*, **134**, 63-90.
- CHAPMAN, S. S. (1961). Developmental problems in *Campanularia*. In H. M. Lenhoff and W. F. Loomis (Eds), *The Biology of Hydra and of some other Coelenterates*. University of Miami Press, Coral Gables. pp. 297-316.
- CHAPSKII, K. K. (1936). The walrus of the Kava Sea. (Russ.) *Trudŭy arkt. nauchno-issled Inst.*, **67**, 1-111.
- CHATTON, E. (1953). Nutrition et culture des amœbiens. In P. P. Grassé (Ed.), *Traité de Zoologie*, Vol. I, Part 2. Masson, Paris. pp. 32-34.
- CHAYANOVA, L. A. (1950). Reproduction and development of pelagic Copepoda of the Black Sea. (Russ.) *Trans. Kargadsk Biol. Stn., Acad. Sci. UKrSSR*, **10**, 78-105.
- CHEN, T. P. (1950). A special report on rearing milkfish in Taiwan. *Teipeh, Formosa: Agri. Impr. Div.*, **1950**, 1-4.
- CHERBONNIER, G. (1949). Primera expedicion Antarctica Chilena: Une nouvelle holothurie incubatrice de l'Antarctique Chilien *Cucumaria vaneyi* n. sp. *Revta Biol. mar.*, **1**, 229-232.
- CHESHER, R. H. (1969). Destruction of Pacific corals by the sea star *Acanthaster planci*. *Science, N. Y.*, **165**, 280-283.
- CHEUNG, T. S. (1964). Contributions to the knowledge of the life history of *Metapenaeus ensis* and other economic species of penaeid prawns in Hong Kong. *J. appl. Ecol.*, **1**, 369-386.
- CHEVREUX, E. (1908). Sur les commensaux du Bernhard l'Hermite. *Bull. Mus. Hist. nat., Paris*, **14**, 14-16.
- CHIA, F. S. (1966). Brooding behaviour of a six-rayed starfish, *Leptasterias hexactis*. *Biol. Bull. mar. biol. Lab., Woods Hole*, **130**, 304-325.
- CHIA, F. S. and CRAWFORD, B. J. (1973). Some observations on gametogenesis, larval development and substratum selection of the sea pen *Ptilosarcus guerneyi*. *Mar. Biol.*, **23**, 73-82.
- CHIDAMBARAM, K. and KURIYAN, G. (1952). Notes on the grey mullets (*Mugil* spp.) of Krusadai Island, Gulf of Manaar. *J. Bombay nat. Hist. Soc.*, **50**, 515-519.
- CHIPPERFIELD, P. N. J. (1951). The breeding of *Crepidula fornicata* (L.), in the River Blackwater, Essex. *J. mar. biol. Ass. U.K.*, **30**, 49-71.
- CHITTLEBOROUGH, R. G. (1974). Review of prospects for rearing rock lobsters. *Aust. Fish.*, **33**, 4-8.
- CHITWOOD, B. G. and CHITWOOD, M. B. (1938). Notes on the 'culture' of aquatic nematodes. *J. Wash. Acad. Sci.*, **28**, 455-460.
- CHITWOOD, B. G. and MURPHY, D. G. (1964). Observations on two marine monhysterids—their classification, cultivation, and behavior. *Trans. Am. microsc. Soc.*, **83**, 311-329.
- CHITWOOD, B. G. and TIMM, R. W. (1954). Free-living nematodes of the Gulf of Mexico. *Fishery Bull. Fish. Wildl. Serv.*, **55**, 313-323.
- CHOE, S. (1962). Biology of the Japanese common sea cucumber *Stichopus japonicus* SELENKA. (Jap.) *Fisheries College, Pusan National University*.

- CHOE, S. (1970). Studies on feeding and growth of the oriental brown shrimp, *Penaeus japonicus* BATE. *Bull. Korean Fish. Soc.*, **3**, 161-171.
- CHOE, S. (1971). Body increases during molt and molting cycle of the oriental brown shrimp *Penaeus japonicus*. *Mar. Biol.*, **9**, 31-37.
- CHOUHDURY, P. C. (1970). Complete larval development of the palaemonid shrimp *Macrobrachium acanthurus* (WIEGMANN, 1836), reared in the laboratory. *Crustaceana*, **18**, 113-132.
- CHOUHDURY, P. C. (1971a). Complete larval development of the palaemonid shrimp, *Macrobrachium carcinus* (L.), reared in the laboratory (Decapoda, Palaemonidae). *Crustaceana*, **20**, 51-69.
- CHOUHDURY, P. C. (1971b). Responses of larval *Macrobrachium carcinus* (L.) to variations in salinity and diet (Decapoda, Palaemonidae). *Crustaceana*, **20**, 113-120.
- CHOUHDURY, P. C. (1971c). Laboratory rearing of larvae of the palaemonid shrimp *Macrobrachium acanthurus* (WIEGMANN, 1836). *Crustaceana*, **21**, 113-126.
- CHRISTENSEN, A. M. (1957). The feeding behavior of the seastar *Evasterias troschelii* STIMPSON. *Limnol. Oceanogr.*, **2**, 180-197.
- CHRISTIANSEN, M. E., COSTLOW, J. D., JR. and MONROE, R. J. (in press). Effects of the juvenile hormone mimic ZR-515 (Altosid®) on larval development of the mud crab *Rhithropanopeus harrisi* in various salinities and cyclic temperatures. *Mar. Biol.*
- CHU, G. W. T. C. and RYAN, E. P. (1960). A technique for maintenance of the snail *Littorina pintade* in the laboratory. *J. Parasit.*, **46**, 249.
- CLARK, A. H. (1934). A voracious starfish. *Science, N. Y.*, **79**, 432.
- CLARK, A. H. (1950). Echinoderms from the Cocos-Keeling Islands. *Bull. Raffles Mus.*, **22**.
- CLARK, A. H. and CLARK, A. M. (1967). A monograph of the existing crinoids. *Bull. U.S. natn. Mus.*, **82**, 1-860.
- CLARK, H. E. S. (1963). Asteroidea. *Mem. N.Z. oceanogr. Inst.*, **21**, 1-84.
- CLARK, H. L. (1898). *Synapta vivipara*: a contribution to the morphology of echinoderms. *Mem. Boston Soc. nat. Hist.*, **5**, 53-88.
- CLARK, H. L. (1901). The holothurians of the Pacific Coast of North America. *Zool. Anz.*, **24**, 162-171.
- CLARK, H. L. (1902). The breeding habits of the holothurians. *Rep. Mich. Acad. Sci.*, **3**, 83-85.
- CLARK, H. L. (1910). The development of an apodous holothurian (*Chiridota rotifera*). *J. exp. Zool.*, **9**, 497-516.
- CLARK, H. L. (1923). The echinoderm fauna of South Africa. *Ann. S. Afr. Mus.*, **13**, 221-426.
- CLARK, R. B. (1959). The tubicolous habit and the fighting reactions of the polychaete *Nereis pelagica*. *Anim. Behav.*, **7**, 85-90.
- CLARK, R. B. (1960). Habituation of the polychaete *Nereis* to sudden stimuli. I. General properties of the habituation process. *Anim. Behav.*, **8**, 82-91.
- CLAUSEN, C. (1971). Effects of temperature on the rate of ⁴⁵calcium uptake by *Pocillopora damicornis*. In H. M. Lenhoff, L. Muscatine and L. V. Davis (Eds), *Experimental Coelenterate Biology*. University of Hawaii Press, Honolulu. pp. 246-259.
- CLEGG, J. S. (1964). The control of emergence and metabolism by external osmotic pressure and the role of free glycerol in developing cysts of *Artemia salina*. *J. exp. Biol.*, **41**, 879-892.
- CLELAND, K. W. (1953). Heavy metals, fertilization and cleavage in the eggs of *Psammococcus miliaris*. *Expl Cell. Res.*, **4**, 246-248.
- CLEMENTE, L. and ANICETE, B. (1949). Sex ratio, sexual dimorphism and early development of *Archaster typicus*. *Nat. appl. Sci. Bull. Univ. Philipp.*, **9**, 109-125.
- COATES, C. W. (1961). Aquatic mammal exhibit at New York Aquarium. *Int. Zoo Yb.*, **3**, 53-54.
- COATES, C. W. (1962). Walrus and whales in the New York Aquarium. *Int. Zoo Yb.*, **4**, 10-12.
- COATES, C. W. and ATZ, J. W. (1958). Olaf: 1,000 pounds of walrus charm. *Anim. Kingd.*, **61**, 66-72.
- COBB, N. A. (1930). The dermalian vessels in nemas of the genus *Oncholaimus*; with notes on four new oncholaims. *J. Wash. Acad. Sci.*, **20**, 225-241.
- COBB, N. A. (1932). *Metoncholaimus pristiurus* (ZUR STRASSEN); a nema suitable for use in laboratory courses in zoology. *J. Wash. Acad. Sci.*, **22**, 344-354.

- COE, W. R. (1912). Echinoderms of Connecticut. *Bull. Conn. St. geol. nat. Hist. Surv.*, **19**, 1-152.
- COE, W. R. (1947). Biology of *Crepidula williamsi*, a new species of prosobranch gastropod from the Pacific coast. *J. Morphol.*, **81**, 241-248.
- COE, W. R. (1948). Nutrition and sexuality in protandric gastropods of the genus *Crepidula*. *Biol. Bull. mar. biol. Lab., Woods Hole*, **94**, 158-160.
- COFFIN, H. G. (1958). The laboratory culture of *Pagurus samuelis* (STIMPSON) (Crustacea, Decapoda). *Walla Walla Coll. Publs Dep. biol. Sci.*, **22**, 1-5.
- COLE, H. A. (1937). Experiments in the breeding of oysters (*Ostrea edulis*) in tanks, with special reference to the food of the larva and spat. *Fishery Invest., Lond.* (Ser. II), **15**, 1-28.
- COLE, H. A. (1939). Further experiments in the breeding of oysters (*Ostrea edulis*) in tanks. *Fishery Invest., Lond.* (Ser. II), **16**, 1-47.
- COLES, S. L. (1969). Quantitative estimates of feeding and respiration for three scleractinian corals. *Limnol. Oceanogr.*, **14**, 949-953.
- COLLIER, R. S., MILLER, J. E. and DAWSON, M. A. (1973). Physiological response of the mud crab, *Eurypanopeus depressus* to cadmium. *Bull. environ. Contam. & Toxicol.*, **10**, 378-382.
- COLWIN, L. H. (1948). Note on the spawning of the holothurian, *Thyone briareus* (LESUEUR). *Biol. Bull. mar. biol. Lab., Woods Hole*, **95**, 296-306.
- COMBS, B. D., BURROWS, R. E. and BIGEY, R. G. (1959). The effect of controlled light on the maturation of adult blue back salmon. *Progve Fish Cult.*, **21**, 63-69.
- COMITA, G. W. and COMITA, J. J. (1966). Egg production in *Tigriopus brevicornis*. In H. Barnes (Ed.), *Some Contemporary Studies in Marine Science*. Allen and Unwin, London. pp. 171-185.
- CONANT, F. S. (1898). The Cubomedusae. *Mem. biol. Lab. Johns Hopkins Univ.*, **4**, 1-61.
- CONBOY, M. E. (1975). Project 'quick find': a marine mammal system for object recovery. *Rapp. P.-v. Réun. Cons. int. Explor. Mer*, **169**, 487-500.
- CONES, H. N., JR. (1969). Strobilation of *Chrysaora quinquecirrha* polyps in the laboratory. *Va J. Sci.*, **20**, 16-18.
- CONKLIN, E. G. (1906). Sex differentiation in *Dinophilus*. *Science, N.Y.*, **24**, 294-295.
- CONNELL, J. J. (1961). The relative stabilities of the skeletal muscle myosins of some animals. *Biochem. J.*, **80**, 503-509.
- CONOVER, R. J. (1960). The feeding behavior and respiration of some marine planktonic Crustacea. *Biol. Bull. mar. biol. Lab., Woods Hole*, **119**, 205-239.
- CONOVER, R. J. (1962). Metabolism and growth in *Calanus hyperboreus* in relation to its life cycle. *Rapp. P.-v. Réun. Cons. perm. int. Explor. Mer*, **153**, 190-197.
- CONOVER, R. J. (1965). Notes on the molting cycle, development of sexual characters and sex ratio on *Calanus hyperboreus*. *Crustaceana*, **8**, 308-320.
- CONOVER, R. J. (1966a). Feeding on large particles by *Calanus hyperboreus* (KRÖYER). In H. Barnes (Ed.), *Some Contemporary Studies in Marine Science*. Allen and Unwin, London. pp. 187-194.
- CONOVER, R. J. (1966b). Factors affecting the assimilation of organic matter by zooplankton and the question of superfluous feeding. *Limnol. Oceanogr.*, **11**, 346-354.
- CONOVER, R. J. (1967). Reproductive cycle, early development, and fecundity in laboratory populations of the copepod *Calanus hyperboreus*. *Crustaceana*, **13**, 61-72.
- CONOVER, R. J. (1970). Cultivation of plankton populations. Convener's report on an Informal Session held during the International Helgoland Symposium 1969. *Helgoländer wiss. Meeresunters.*, **21**, 401-444.
- CONOVER, R. J. (in press). Transformation of organic matter. In O. Kinne (Ed.), *Marine Ecology*, Vol. IV, Dynamics. Wiley, London.
- CONOVER, R. J. and LALLI, C. M. (1972). Feeding and growth in *Clione limacina* (PHIPPS), a pteropod mollusc. *J. exp. mar. Biol. Ecol.*, **9**, 279-302.
- COOK, C. B. (1971). Transfer of ³⁵S-labelled material from food ingested by *Aiptasia* sp. to its endosymbiotic zooxanthellae. In H. M. Lenhoff, L. Muscatine and L. V. Davis (Eds), *Experimental Coelenterate Biology*. University of Hawaii Press, Honolulu. pp. 218-224.
- COOK, H. L. (1969). A method of rearing penaeid shrimp larvae for experimental studies. *F.A.O. Fish. Rep.*, **57**, 709-715.

- COOK, H. L. and LINDNER, M. J. (1970). Synopsis of biological data on the brown shrimp *Penaeus aztecus aztecus* IVES, 1891. *F.A.O. Fish. Rep.*, **57**, 1471-1497.
- COOK, H. L. and MURPHY, M. A. (1969). The culture of the larval penaeid shrimp. *Trans. Am. Fish. Soc.*, **98**, 751-754.
- COOK, H. W. and BAKER, B. E. (1969). Seal milk I, harp seal (*Pagophilus groenlandicus*) milk: composition and pesticide residue content. *MacDonald Coll. J.*, **1969**. (Quoted from RIDGWAY 1972b.)
- COPELAND, M. (1925). Chemical reactions of *Nereis virens*. *Anat. Rec.*, **31**, 331.
- COPELAND, M. (1935). Keeping *Nereis* for physiological study. *Biol. Bull. mar. biol. Lab., Woods Hole*, **69**, 337.
- COPELAND, M. and BROWN, A. (1934). Modification of behavior in *Nereis virens*. *Biol. Bull. mar. biol. Lab., Woods Hole*, **67**, 356-364.
- COPELAND, M. and WIEMAN, H. L. (1924). The chemical sense and feeding behavior of *Nereis virens* SARS. *Biol. Bull. mar. biol. Lab., Woods Hole*, **47**, 231-238.
- CORKETT, C. J. (1967). Technique for rearing marine calanoid copepods in laboratory conditions. *Nature, Lond.*, **216**, 58-59.
- CORKETT, C. J. (1968). La reproduction en laboratoire des copépodes marins *Acartia clausi* GIESBRECHT et *Idya furcata* (BAIRD). *Pelagos*, **10**, 77-90.
- CORKETT, C. J. (1970). Techniques for breeding and rearing marine calanoid copepods. *Helgoländer wiss. Meeresunters.*, **20**, 318-324.
- CORKETT, C. J. and McLAREN, I. A. (1969). Egg production and oil storage by the copepod *Pseudocalanus* in the laboratory. *J. exp. mar. Biol. Ecol.*, **3**, 90-105.
- CORKETT, C. J. and McLAREN, I. A. (1970). Relationships between development rate of eggs and older stages of copepods. *J. mar. biol. Ass. U.K.*, **50**, 161-168.
- CORKETT, C. J. and URRY, D. L. (1968). Observations on the keeping of adult female *Pseudocalanus elongatus* under laboratory conditions. *J. mar. biol. Ass. U.K.*, **48**, 97-105.
- CORLISS, J. O. (1961). *The Ciliated Protozoa*, Vol. VII, Pergamon Press, Oxford.
- CORLISS, J. O. (1973a). Guide to the literature on *Tetrahymena*: A comparison piece to Elliott's 'General Bibliography'. *Trans. Am. microsc. Soc.*, **92**, 468-491.
- CORLISS, J. O. (1973b). Protozoan ecology: a note on its current status. *Am. Zool.*, **13**, 145-148.
- CORNER, E. D. S. (1961). On the nutrition and metabolism of zooplankton. I. Preliminary observations on the feeding of the marine copepod, *Calanus helgolandicus* (CLAUS). *J. mar. biol. Ass. U.K.*, **41**, 5-16.
- CORNER, E. D. S., HEAD, R. N. and KILVINGTON, C. C. (1972). On the nutrition and metabolism of zooplankton. VIII. The grazing of *Biddulphia* cells by *Calanus helgolandicus*. *J. mar. biol. Ass. U.K.*, **52**, 847-861.
- CORNER, E. D. S., SOUTHWARD, A. J. and SOUTHWARD, E. C. (1968). Toxicity of oil-spill removers ('detergents') to marine life: an assessment using the intertidal barnacle *Elminius modestus*. *J. mar. biol. Ass. U.K.*, **48**, 29-48.
- CORNER, E. D. S. and SPARROW, B. W. (1956). The modes of action of toxic agents. I. Observations on the poisoning of certain crustaceans by copper and mercury. *J. mar. biol. Ass. U.K.*, **35**, 531-548.
- CORY, R. L. (1967). Epifauna of the Patuxent River Estuary, Maryland, for 1963 and 1964. *Chesapeake Sci.*, **8**, 71-89.
- COSTELLO, D. P., DAVIDSON, M. E., EGGERS, A., FOX, M. H. and HENLEY, C. (1957). Methods for obtaining and handling marine eggs and embryos. *Woods Hole, Mass., Marine Biological Laboratory*.
- COSTELLO, T. J. and ALLEN, D. M. (1959). Migration and growth of pink shrimp. *Circ. Fish Wildl. Serv. Wash.*, **62**, 13-18.
- COSTELLO, T. J. and ALLEN, D. M. (1961). Migrations, mortality, and growth of pink shrimp. *Circ. Fish Wildl. Serv. Wash.*, **129**, 18-21.
- COSTELLO, T. J. and ALLEN, D. M. (1970). Synopsis of biological data on the pink shrimp *Penaeus duorarum duorarum* BURKENROAD, 1939. *F.A.O. Fish. Rep.*, **57**, 1499-1537.
- COSTLOW, J. D., JR. (1959). Effect of carbonic anhydrase inhibitors on shell development and growth of *Balanus improvisus* DARWIN. *Physiol. Zool.*, **32**, 177-184.

- COSTLOW, J. D., JR. (Ed.) (1969). *Marine Biology, V, Proceedings of the Fifth Interdisciplinary Conference on Marine Biology*. Gordon and Breach, New York.
- COSTLOW, J. D., JR. (1976). The effect of juvenile hormone mimics on development of the mud-crab, *Rhithropanopeus harrisi* (GOULD). In A. Calabrese, F. P. Thurberg and J. F. Vernberg (Eds), *Pollution and the Physiology of Marine Organisms*. Academic Press, New York.
- COSTLOW, J. D., JR. and BOOKHOUT, C. G. (1953). Moulting and growth in *Balanus improvisus*. *Biol. Bull. mar. biol. Lab., Woods Hole*, **105**, 420-433.
- COSTLOW, J. D., JR. and BOOKHOUT, C. G. (1956). Molting and shell growth in *Balanus amphitrite niveus*. *Biol. Bull. mar. biol. Lab., Woods Hole*, **110**, 107-116.
- COSTLOW, J. D., JR. and BOOKHOUT, C. G. (1957a). Larval development of *Balanus eburneus* in the laboratory. *Biol. Bull. mar. biol. Lab., Woods Hole*, **112**, 313-324.
- COSTLOW, J. D., JR. and BOOKHOUT, C. G. (1957b). Body growth versus shell growth in *Balanus improvisus*. *Biol. Bull. mar. biol. Lab., Woods Hole*, **113**, 224-232.
- COSTLOW, J. D., JR. and BOOKHOUT, C. G. (1958a). Larval development of *Balanus amphitrite* var. *denticulata* BROCH reared in the laboratory. *Biol. Bull. mar. biol. Lab., Woods Hole*, **114**, 284-295.
- COSTLOW, J. D., JR. and BOOKHOUT, C. G. (1958b). Moulting and growth in *Balanus*. *Int. Congr. Zool.*, **15**, 297-298.
- COSTLOW, J. D., JR. and BOOKHOUT, C. G. (1958c). Moulting and respiration in *Balanus amphitrite* var. *denticulata* BROCH. *Physiol. Zool.*, **31**, 271-280.
- COSTLOW, J. D., JR. and BOOKHOUT, C. G. (1960a). A method for developing brachyuran eggs *in vitro*. *Limnol. Oceanogr.*, **5**, 212-215.
- COSTLOW, J. D., JR. and BOOKHOUT, C. G. (1960b). The complete larval development of *Sesarma cinereum* Bosc reared in the laboratory. *Biol. Bull. mar. biol. Lab., Woods Hole*, **118**, 203-214.
- COTTE, J. (1903). Contribution a l'étude de la nutrition chez les Spongiaires. *Bull. scient. Fr. Belg.*, **38**, 420-573.
- COTTE, J. (1908). Sponge culture. *Bull. Bur. Fish., Wash.*, **28**, 587-614.
- COULSON, J. C. and HICKLING, G. (1964). The breeding biology of the Grey seal, *Halichoerus grypus* (FAB.), on the Farne Islands, Northumberland. *J. Anim. Ecol.*, **33**, 485-512.
- COUPIN, H. (1894). Sur l'alimentation de deux commensaux (*Nereilepas* et *Pinnotheres*). *C.r. hebd. Séanc. Acad. Sci., Paris*, **119**, 540-543.
- COWEY, C. B. (1976). Use of synthetic diets and biochemical criteria in the assessment of nutrient requirements of fish. *J. Fish. Res. Bd Can.*, **33**, 1040-1045.
- COWEY, C. B., ADRON, J. W. and BLAIR, A. (1970a). Studies on the nutrition of marine flatfish. The essential amino acid requirements of plaice and sole. *J. mar. biol. Ass. U.K.*, **50**, 87-95.
- COWEY, C. B., ADRON, J. W., BLAIR, A. and POPE, J. (1970b). The growth of O-group plaice on artificial diets containing different levels of protein. *Helgoländer wiss. Meeresunters.*, **20**, 602-609.
- COWEY, C. B., ADRON, J. W., KNOX, D. and BALL, G. T. (1975). Studies on the nutrition of marine flatfish. The thiamin requirement of turbot (*Scophthalmus maximus*). *Br. J. Nutr.*, **34**, 383-390.
- COWEY, C. B. and FORSTER, J. R. M. (1971). The essential amino-acid requirements of the prawn *Palaemon serratus*. The growth of prawns on diets containing proteins of different amino-acid compositions. *Mar. Biol.*, **10**, 77-81.
- COWEY, C. B., POPE, J. A., ADRON, J. W. and BLAIR, A. (1971). Studies on the nutrition of marine flatfish. Growth of the plaice *Pleuronectes platessa* on diets containing proteins derived from plants and other sources. *Mar. Biol.*, **10**, 145-153.
- COWEY, C. B., POPE, J. A., ADRON, J. W. and BLAIR, A. (1972). Studies on the nutrition of marine flatfish. The protein requirement of plaice (*Pleuronectes platessa*). *Br. J. Nutr.*, **28**, 447-456.
- COWLES, R. P. (1903). Notes on the rearing of the larvae of *Polygordius*. *Johns Hopkins Univ. Circ.*, **22**, No. 161 (unpaginated).
- CRANDALL, L. S. (1964). *The Management of Wild Animals in Captivity*, University of Chicago Press, Chicago.

- CRANFIELD, H. J. (1970). Some effects of experimental procedure on settlement of *Ostrea lutaria* HUTTON. *N.Z. Jl mar. freshw. Res.*, **4**, 63-69.
- CRAWSHAY, L. R. (1913). Notes on experiments in the keeping of plankton animals under artificial conditions. *J. mar. biol. Ass. U.K.*, **10**, 555-576.
- CREUTZBERG, F. (1975). Orientation in space: animals, invertebrates. In O. Kinne (Ed.), *Marine Ecology*, Vol. II, Physiological Mechanisms, Part 2. Wiley, London. pp. 555-655.
- CRISP, D. J. (1954). The breeding of *Balanus porcatus* (DA COSTA) in the Irish Sea. *J. mar. biol. Ass. U.K.*, **33**, 473-496.
- CRISP, D. J. (1957). Effect of low temperature on the breeding of marine animals. *Nature, Lond.*, **179**, 1138-1139.
- CRISP, D. J. (1959a). Factors influencing the time of breeding of *Balanus balanoides*. *Oikos*, **10**, 275-289.
- CRISP, D. J. (1959b). The rate of development of *Balanus balanoides* (L.) embryos *in vitro*. *J. Anim. Ecol.*, **28**, 119-132.
- CRISP, D. J. and CLEGG, D. J. (1960). The induction of the breeding condition in *Balanus balanoides*. *Oikos*, **11**, 265-275.
- CRISP, D. J. and DAVIES, P. A. (1955). Observations *in vivo* on the breeding of *Elminius modestus* grown on glass slides. *J. mar. biol. Ass. U.K.*, **34**, 357-380.
- CRISP, D. J. and PATEL, B. (1969). Environmental control of the breeding of three boreo-arctic cirripedes. *Mar. Biol.*, **2**, 283-295.
- CROLL, N. A. and VIGLIERCHIO, D. R. (1969). Osmoregulation and the uptake of ions in a marine nematode. *Proc. helminth. Soc. Wash.*, **36**, 1-9.
- CROWELL, S. (1953). The regression-replacement cycle of hydranths of *Obelia* and *Campanularia*. *Physiol. Zool.*, **26**, 319-327.
- CROWELL, S. (1957). Differential responses of growth zones to nutritive level, age, and temperature in the colonial hydroid, *Campanularia*. *J. exp. Zool.*, **134**, 63-90.
- CROWELL, S. and WYTENBACH, C. (1957). Factors affecting terminal growth in the hydroid *Campanularia*. *Biol. Bull. mar. biol. Lab., Woods Hole*, **113**, 233-244.
- CROWELL, S., WYTENBACH, C. and SUDDITH, R. L. (1965). Evidence against the concept of growth zones in hydroids. *Biol. Bull. mar. biol. Lab., Woods Hole*, **129**, 403.
- CROZIER, W. J. (1918). The amount of bottom material ingested by holothurians (*Stichopus*). *J. exp. Zool.*, **26**, 379-385.
- CRUICKSHANK, E. M. (1962). Fat soluble vitamins. In G. Borgstrom (Ed.), *Fish as Food*. II. Academic Press, New York. pp. 175-203.
- CSORDAS, S. E. (1963). Sea lions on Macquarie Island. *Victoria Nat.*, **80**, 32-35.
- CULLINEY, J. L. (1971). Laboratory rearing of the larvae of the mahogany date mussel *Lithophaga bisulcata*. *Bull. mar. Sci.*, **21**, 591-602.
- CUNNINGHAM, J. T. (1894). Experiments on the rearing of fish larvae in the season of 1894. *J. mar. biol. Ass. U.K.*, **3**, 206-207.
- CUNNINGHAM, J. T. (1898). On the development of lobster rearing. *Nature, Lond.*, **59**, 26-62.
- CUNNINGHAM, P. A. and TRIPP, M. R. (1973). Accumulation and depuration of mercury in the American oyster *Crassostrea virginica*. *Mar. Biol.*, **20**, 14-19.
- CUNNINGHAM, P. A. and TRIPP, M. R. (1975a). Factors affecting the accumulation and removal of mercury from tissues of the American oyster *Crassostrea virginica*. *Mar. Biol.*, **31**, 311-319.
- CUNNINGHAM, P. A. and TRIPP, M. R. (1975b). Accumulation, tissue distribution and elimination of $^{203}\text{HgCl}_2$ and $\text{CH}_3\ ^{208}\text{HgCl}$ in the tissues of the American oyster *Crassostrea virginica*. *Mar. Biol.*, **31**, 321-334.
- CURTIS, A. S. G. (1962). Pattern and mechanism in the reaggregation of sponges. *Nature, Lond.*, **196**, 245-248.
- CURTIS, A. S. G. (1970). Problems and some solutions in the study of cellular aggregation. *Symp. zool. Soc. Lond.*, **25**, 335-352.
- CURTIS, L. (1962a). The Amazon dolphin, *Inia geoffrensis*, at the Fort Worth Zoological Park. *Int. Zoo Yb.*, **4**, 7-10.
- CURTIS, L. (1962b). Aquarium-type outdoor otter exhibit. *Int. Zoo Yb.*, **4**, 44-45.
- CURTIS, L. (1973). Aspects of the life cycle of *Sabellaria vulgaris* VERRILL (Polychaeta: Sabellariidae) in Delaware Bay. Ph.D. Thesis, University of Delaware.

- CUSHING, D. H. (1958). The effect of grazing in reducing the primary production: a review. *Rapp. P.-v. Réun. Cons. perm. int. Explor. Mer*, **144**, 149–154.
- CUTLER, D. W. and CRUMP, L. M. (1923). Rate of reproduction in an artificial culture of *Colpidium colpoda*. *Biochem. J.*, **17**, 875–886.
- CZIHAK, G. (1960). Untersuchungen über die Coelomanlagen und die Metamorphose des Pluteus von *Psammechinus miliaris*. *Zool. Jb. (Anat. Ontogenie Tiere)*, **78**, 235–256.
- CZIHAK, G. (1962). Entwicklungsphysiologie der Echinodermen. *Fortschr. Zool.*, **14**, 238–267.
- CZIHAK, G. (Ed.) (1975). *The Sea Urchin Embryo—Biochemistry and Morphogenesis*, Springer-Verlag, Berlin.
- D'AGOSTINO, A. S. and FARMANFARMAIAN, A. (1960). Transport of nutrients in the holothurian *Leptosynapta inhaerens*. *Biol. Bull. mar. biol. Lab., Woods Hole*, **119**, 301.
- DAHLSTRÖM, W. A. (1970). Synopsis of biological data on the ocean shrimp *Pandalus jordani* RATHBUN, 1902. *F.A.O. Fish. Rep.*, **57**, 1377–1416.
- DAHM, E. (1975). Untersuchungen zum Nahrungserwerb von *Crangon crangon* LINNÉ. *Ber. dt. wiss. Komm. Meeresforsch.*, **24**, 105–133.
- DAKIN, W. J. (1953). *Australian Sea-Shores*, Angus & Robertson, London.
- DALES, R. P. (1952). The development and structure of the anterior region of the body in the Sabellariidae, with special reference to *Phragmatopoma californica*. *Q. Jl microsc. Sci.*, **93**, 435–452.
- DALES, R. P. (1955). Feeding and digestion in the terebellid polychaete. *J. mar. biol. Ass. U.K.*, **34**, 55–79.
- DAN, K. and KUBOTA, H. (1960). Data on the spawning of *Comanthus japonica* between 1937 and 1955. *Embryologia*, **5**, 21–37.
- DANIEL, A. (1958). The development and metamorphosis of three species of sessile barnacles. *J. Madras Univ.*, **B28**, 23–47.
- DANNEVIG, A. (1928). The rearing of lobster larvae at Flødevigen. *Rep. Fish. Marine Invest. Norway*, **2-3**, 1–15.
- DANNEVIG, A. (1948). Rearing experiments at the Flødevigen seafish hatchery 1943–1947. *J. Cons. perm. int. Explor. Mer*, **15**, 277–283.
- DARLING, F. (1950). Seals of the world. *Zoo Life*, **5**, 2–7.
- D'ASARO, C. N. (1973). Cultured lugworms—a new source of bait for marine sport fishermen. *Am. Fish Farmer*, **4**, 4–7.
- DAVID, L. R. (1939). Embryonic and early larval stages of the grunion, *Leuresthes tenuis*, and of the sculpin, *Scorpaena guttata*. *Copeia*, **1939**, 75–81.
- DAVIDSON, M. E. and BERRILL, N. J. (1948). Regeneration of primordia and developing hydranths of *Tubularia*. *J. exp. Zool.*, **107**, 465–477.
- DAVIS, H. C. (1953). On food and feeding of larvae of the American oyster, *C. virginica*. *Biol. Bull. mar. biol. Lab., Woods Hole*, **104**, 334–350.
- DAVIS, H. C. and CALABRESE, A. (1964). Combined effects of temperature and salinity on development of eggs and growth of larvae of *M. mercenaria* and *C. virginica*. *Fishery Bull. Fish Wildl. Serv. U.S.*, **63**, 643–655.
- DAVIS, H. C. and CALABRESE, A. (1969). Survival and growth of larvae of the European oyster (*Ostrea edulis* L.) at different temperatures. *Biol. Bull. mar. biol. Lab., Woods Hole*, **136**, 193–199.
- DAVIS, H. C. and GUILLARD, R. R. (1958). Relative value of ten genera of micro-organisms as foods for oyster and clam larvae. *Fishery Bull. Fish Wildl. Serv. U.S.* (No. 136), **58**, 293–304.
- DAVIS, H. C. and LOOSANOFF, V. L. (1953). Utilization of different food organisms by clam larvae. *Anat. Rec.*, **117**, 646.
- DAVIS, L. V. (1971). Growth and development of colonial hydroids. In H. M. Lenhoff, L. Muscatine and L. V. Davis (Eds), *Experimental Coelenterate Biology*. University of Hawaii Press, Honolulu. pp. 16–36.
- DAYKIN, P. N. (1965). Application of mass transfer theory to the problem of respiration of fish eggs. *J. Fish. Res. Bd Can.*, **22**, 159–171.
- DAYTON, P. K. and HESSLER, R. R. (1972). Role of biological disturbance in maintaining diversity in the deep sea. *Deep Sea Res.*, **19**, 199–208.
- DECOPAS, F., HART, J. S. and FISHER, H. D. (1971). Sea water drinking and water flux in starved and in fed harbor seals, *Phoca vitulina*. *Can. J. Physiol. Pharmacol.*, **49**, 53–62.

- DELAGE, Y. (1884). Évolution de la Sacculine. *Archs Zool. exp. gén.*, **2**, 417-736.
- DELAP, M. J. (1901). Notes on the rearing of *Chrysaora isosceles* in an aquarium. *The Irish Naturalist*, **10**, 25-28.
- DELAP, M. J. (1905). Notes on the rearing in an aquarium of *Cyanea lamarcki*. *Rep. Sea inld Fish. Ire.* (1902 and 1903), **2**, 20-24.
- DELAP, M. J. (1907). Notes on the rearing in an aquarium of *Aurelia aurita* L. and *Pelagia perla* (SLABBER). *Rep. Sea inld Fish Ire. Sci. Invest.*, **1905**, Part II, 160-164.
- DELAVAUULT, R. (1966). Sex determination. In R. A. Boolootian (Ed.), *Physiology of the Echinodermata*. Interscience Publishers, New York. pp. 615-638.
- DELMENDO, M. N. and RABANAL, H. R. (1956). Cultivation of 'Sugpo' (jumbo tiger shrimp) *Penaeus monodon* FABRICIUS, in the Philippines. *Proc. Indo-Pacif. Fish. Council.*, **6**, 424-431.
- DELMONTE, P. J., RUBINOFF, I. and RUBINOFF, R. W. (1968). Laboratory rearing through metamorphosis of some Panamanian gobies. *Copeia*, **1968**, 411-412.
- DELONG, R. L., GILMARTIN, W. G. and SIMPSON, J. G. (1973). Premature births in California sea lions: association with high organochlorine pollutant residue levels. *Science, N. Y.*, **181**, 1168-1169.
- DEMAR-GERVAIS, C. (1971). Recherches sur le cycle biologique de *Fabrea salina* HENNEGUY. Ph.D. Thesis, University of Paris.
- DEOLALKAI, S. T. and SOHONIE, K. (1957a). Studies on thiaminase from fish. I. Properties of thiaminase. *Indian J. med. Res.*, **45**, 571-586.
- DEOLALKAI, S. T. and SOHONIE, K. (1957b). Studies on thiaminase from fish. II. Effect of certain compounds on thiaminase activity. *Indian J. med. Res.*, **45**, 587-592.
- DERBÈS, M. (1847). Observations sur le mécanisme et les phénomènes qui accompagnent la formation de l'embryon chez l'oursin comestible. *Annls Sci. nat., Zool.*, **8**, 80-98.
- DESHIMARU, O. and KUROKI, K. (1974a). Studies on a purified diet for prawn. I. Basal composition of diet. *Bull. Jap. Soc. scient. Fish.*, **40**, 413-419.
- DESHIMARU, O. and KUROKI, K. (1974b). Studies on a purified diet for prawn. II. Optimum contents of cholesterol and glucosamine in the diet. *Bull. Jap. Soc. scient. Fish.*, **40**, 421-424.
- DESHIMARU, O. and SHIGENO, K. (1972). Introduction to the artificial diet for prawn *Penaeus japonicus*. *Aquaculture*, **1**, 115-133.
- DEUEL, D. G., CLARK, J. R. and MANSUETI, A. J. (1966). Description of embryonic and early larval stages of bluefish, *Pomatomus saltatrix*. *Trans. Am. Fish. Soc.*, **95**, 264-271.
- DE WINTER, F. and PERSOONE, G. (in press). Preliminary experiments with the ciliate *Fabrea salina* as a potential live food for mariculture purposes. In G. Persoone and E. Jaspers (Eds.), *Tenth European Marine Biology Symposium*. Ostend, Belgium. 1975.
- DEXTER, D. M. (1972). Molting and growth in laboratory reared phyllosomes of the California spiny lobster, *Panulirus interruptus*. *Calif. Fish Game*, **58**, 107-115.
- DICKERSON, B. L., FISCHER, E. C. and LILLY, D. M. (1963). Axenic cultures of *Paramecium calkinsi* for osmotic experiments. *Am. Zool.*, **3**, 281.
- DICKIE, L. M. and MEDCOF, J. C. (1963). Causes of mass mortalities of scallops (*Placopecten magellanicus*) in the southwestern Gulf of St. Lawrence. *J. Fish. Res. Bd Can.*, **20**, 451-482.
- DIETRICH, G. and KALLE, K. (1963). *General Oceanography*, Interscience. New York.
- DIETZ-ELBRÄCHTER, G. (1971). Untersuchungen über die Zooxanthellen der Foraminifera *Heterostegina depressa* ORBIGNY 1826. 'Meteor' *ForschErgebn.*, **6**, 41-47.
- DISALVO, L. H. (1971). Ingestion and assimilation of bacteria by two scleractinian coral species. In H. M. Lenhoff, L. Muscatine and L. V. Davis (Eds), *Experimental Coelenterate Biology*. University of Hawaii Press, Honolulu. pp. 129-136.
- DIX, T. G. (1970). Biology of *Evechinus chloroticus* (Echinoidea: Echinometridae) from different localities. *N.Z. J. mar. freshwat. Res.* **4**, 91-116.
- DIXON, D. R. (in press). The energetics of growth and reproduction in the brackish water serpulid *Mercierella enigmatica* (FAUVEL). In G. Persoone and E. Jaspers (Eds), *Tenth European Marine Biology Symposium*. Ostend, Belgium, 1975.
- DJAKONOV, A. (1926). Zwei neue Seesterne aus dem Westlichen Nord Pacific. *Ezheg. zool. Muz.*, **27**, 310-319.

- DJAKONOV, A. (1938). The Echinodermata of Siankhu Bay (Japan Sea). *Reports of the Japan Sea hydrobiological expedition of the Zoological Institute of the Academy of Sciences of the USSR in 1934*, 425-498.
- DOBKIN, S. (1961). Early developmental stages of pink shrimp, *Penaeus duorarum* from Florida waters. *Fishery Bull. Fish Wildl. Serv. U.S.*, **61**, 321-349.
- DOBKIN, S. (1963). The larval development of *Palaemonetes paludosus* (GIBBES, 1850) (Decapoda, Palaemonidae), reared in the laboratory. *Crustaceana*, **6**, 41-61.
- DOBKIN, S. (1971). The larval development of *Palaemonetes cummingi* CHACE, 1954 (Decapoda, Palaemonidae), reared in the laboratory. *Crustaceana*, **20**, 285-297.
- DODD, J. M. (1960). Gonadal and gonadotrophic hormones in lower vertebrates. In A. S. Parks (Ed.), *Marshall's Physiology of Reproduction*. Longmans Green, London. pp. 417-582.
- DÖRJES, J. (1968). Zur Ökologie der Acoela (Turbellaria) in der Deutschen Bucht. *Helgoländer wiss. Meeresunters.*, **18**, 78-115.
- DOEZEMA, P. (1969). Carbohydrates and carbohydrate metabolism of echinoderms. In M. Florin and B. T. Scheer (Eds), *Chemical Zoology*, Vol. III. Academic Press, New York. pp. 101-122.
- DONALDSON, E. M., YAMAZAKI, F., DYE, H. M. and PHILLEO, W. W. (1972). Preparation of gonadotropin from salmon (*Oncorhynchus tshawytscha*) pituitary glands. *Gen. Comp. Endocrinol.*, **18**, 469-481.
- DONALDSON, H. A. (1975). Vertical distribution and feeding of sergestid shrimps (Decapoda: Natantia) collected near Bermuda. *Mar. Biol.*, **31**, 37-50.
- DOREY, A. E. (1965). The organization and replacement of the epidermis in acelous turbellarians. *Q. Jl microsc. Sci.*, **106**, 147-172.
- DOUGHERTY, E. C. (1959). Introduction to axenic culture of invertebrate metazoa: a goal. *Ann. N.Y. Acad. Sci.*, **77**, 27-54.
- DOUGHERTY, E. C. (1960). Cultivation of aschelminths, especially rhabditid nematodes. In J. N. Sasser and W. R. Jenkins (Eds), *Nematology*. University of North Carolina Press, Chapel Hill. pp. 297-318.
- DOUGHERTY, E. C. (1963). Cultivation and nutrition of micrometazoa. III. The minute rotifer *Lecane inermis* (BRYCE, 1892) HARRING, '13. *J. exp. Zool.*, **153**, 183-186.
- DOUGHERTY, E. C. (1964). Cultivation and nutrition of micrometazoa. I. The Antarctic rotifer *Philodina gregaria* MURRAY, 1910. *Trans. Am. microsc. Soc.*, **83**, 1-6.
- DOUGHERTY, E. C., CHITWOOD, B. G. and MAGGENTI, A. R. (1960a). Observations on antarctic fresh-water micrometazoa. *Ant. Rec.*, **137**, 350.
- DOUGHERTY, E. C., FERRAL, D. J., BRODY, B. and GOTTHOLD, M. L. (1963). A growth anomaly and lysis with production of virus-like particles in an axenically reared microannelid. *Nature, Lond.*, **198**, 973-975.
- DOUGHERTY, E. C., FERRAL, D. J. and SOLBERG, B. (1961a). Xenic cultivation of antarctic micrometazoa. 2. The rotifer *Philodina gregaria* MURRAY, '10. *Am. Zool.*, **1**, 208.
- DOUGHERTY, E. C. and HARRIS, L. G. (1964). Renewed axenic cultivation of the monogonont rotifer, *Lecane inermis*. *Am. Zool.*, **4**, 73.
- DOUGHERTY, E. C. and SOLBERG, B. (1959). Laboratory culture of rotifers and gastrotrichs. II. Dixenic, monoxenic, and attempted axenic cultures. (Abstract.) *Anat. Rec.*, **134**, 555-556.
- DOUGHERTY, E. C. and SOLBERG, B. (1961). Axenic cultivation of an enchytraeid annelid. *Nature, Lond.*, **192**, 184-185.
- DOUGHERTY, E. C., SOLBERG, B. and FERRAL, D. J. (1961b). The first axenic cultivation of a rotifer species. *Experientia*, **17**, 131-132.
- DOUGHERTY, E. C., SOLBERG, B. and HARRIS, L. G. (1960b). Synxenic and attempted axenic cultivation of rotifers. *Science, N. Y.*, **132**, 416-417.
- DOUMENGE, F. (1973). Initial organizational work for farming penaeid shrimps in St. Vincent's Bay (New Caledonia). *S. Pac. Isl. Fish. Newsl.*, **10**, 5-21.
- DRAPER, H. H. (1970). The tocopherols. In R. A. Morton (Ed.), *Fat-soluble Vitamins*. Int. Encyclop. Food & Nutrit., Pergamon Press, London. pp. 333-393.
- DRIES, M. and ADELUNG, D. (in press). Neue Ergebnisse über die Aufzucht von *Carcinus maenas* im Laboratorium. *Mar. Biol.*, **38**.
- DROOP, M. R. (1953). Phagotrophy in *Oxyrrhis marina*. *Nature, Lond.*, **172**, 250.

- DROOP, M. R. (1955). A suggested method for the assay of vitamin B₁₂ in sea water. *J. mar. biol. Ass. U.K.*, **34**, 435-440.
- DROOP, M. R. (1958). Requirement for thiamine among some marine and supra-littoral protista. *J. mar. biol. Ass. U.K.*, **37**, 323-329.
- DROOP, M. R. (1959). A note on some physical conditions for cultivating *Oxyrrhis marina*. *J. mar. biol. Ass. U.K.*, **38**, 599-604.
- DROOP, M. R. (1962). *Heteramoeba clara* n. gen. n. sp., a sexual biphasic amoeba. *Arch. Mikrobiol.*, **42**, 254-266.
- DROOP, M. R. (1963). A feeding experiment. *Br. phycol. Bull.*, **2**, 278.
- DROOP, M. R. (1966). Vitamin B₁₂ and marine ecology. III. An experiment with chemostat. *J. mar. biol. Ass. U.K.*, **47**, 659-671.
- DROOP, M. R. (1968). Vitamin B₁₂ and marine ecology. IV. The kinetics of uptake, growth and inhibition in *Monochrysis lutheri*. *J. mar. biol. Ass. U.K.*, **48**, 689-733.
- DROOP, M. R. (1970). Nutritional investigation of phagotrophic protozoa under axenic conditions. *Helgoländer wiss. Meeresunters.*, **20**, 272-277.
- DROOP, M. R. and DOYLE, J. (1966). Ubiquinone as a protozoan growth factor. *Nature, Lond.*, **212**, 1474-1475.
- DROOP, M. R. and PENNOCK, J. F. (1971). Terpenoid quinones and steroids in the nutrition of *Oxyrrhis marina*. *J. mar. biol. Ass. U.K.*, **51**, 455-470.
- DUDOK VAN HEEL, W. H. (1962). Sound and Cetacea. *Neth. J. Sea Res.*, **1**, 407-507.
- DUDOK VAN HEEL, W. H. (1970). The dolphinarium at Harderwijk. *Int. Zoo Yb.*, **10**, 49-51.
- DUDOK VAN HEEL, W. H. (1972). Transport of dolphins. *Aquatic Mammals*, **1**, 1-32.
- DUDOK VAN HEEL, W. H. (1974a). Remarks on a live ziphiid baby (*Mesoplodon bidens*). *Aquatic Mammals*, **2**, 3-7.
- DUDOK VAN HEEL, W. H. (1974b). Birth of dolphins (*Tursiops truncatus*, MONT.) in the dolphinarium Harderwijk, Netherlands. I. *Aquatic Mammals*, **2**, 11-22.
- DUDOK VAN HEEL, W. H. and TIEBOR, J. (1966). Observations in flight reactions of *Tursiops truncatus* (MONT.) with some suggestions in flight planning. *Z. Säugetierk.*, **31**, 370-372.
- DUNATHAN, J. P., INGLE, R. M. and HAVENS, W. K., JR. (1969). Effects of artificial foods upon oyster fattening with potential commercial applications. *Fla Dept. nat. Resources Div. Man. Resour. Tech. Ser.*, **58**, 1-39.
- DUNBAR, M. J. (1941). On the food of seals in the Canadian eastern arctic. *Can. J. Res. (Ser. D)*, **19**, 150-155.
- DUPREE, H. K. (1966). Vitamins essential for growth of channel catfish. *Tech. Pap., U.S. Bur. Sport Fish. Wildl.*, **7**, 3-12.
- DUPREE, H. K. and SNEED, K. E. (1966). Response of Channel catfish fingerlings to different levels of major nutrients in purified diets. *Tech. Pap. U.S. Bur. Sport Fish. Wildl.*, **9**, 1-21.
- DUPUY, J. L. and RIVKIN, S. (1972). The development of laboratory techniques for the production of culch-free spat of the oyster, *Crassostrea virginica*. *Chesapeake Sci.*, **13**, 45-52.
- DURCHON, M. (1948). Épitoque expérimentale chez deux polychètes: *Perinereis cultrifera* GRUBE et *Nereis irrorata* MALMGREN. *C.r. hebd. Séanc. Acad. Sci., Paris*, **227**, 157-158.
- DURCHON, M. (1949). Inhibition de l'épitoque par le prostomium chez les néréidiens (annélides polychètes). *C.r. hebd. Séanc. Acad. Sci., Paris*, **229**, 81-82.
- DURCHON, M. (1950). Maturation génitale précoce, stolonisation et polycéphalie par suppression de la région antérieure chez un syllidien. *C.r. hebd. Séanc. Acad. Sci., Paris*, **230**, 2236-2237.
- DURCHON, M. (1951). L'ablation du prostomium provoque, chez les néréidiens, la maturation précoce des produits génitaux mâles. *C.r. hebd. Séanc. Acad. Sci., Paris*, **232**, 442-443.
- DURCHON, M. (1952). Recherches expérimentales sur deux aspects de la reproduction chez les annélides polychètes: l'épitoque et la stolonisation. *Annls Sci. nat. (11^e sér.)*, **14**, 119-206.
- DURCHON, M. (1956a). Nouvelles recherches expérimentales sur l'épitoque des néréidiens. *Annls Sci. nat. (11^e sér.)*, **18**, 1-13.
- DURCHON, M. (1956b). Rôle du cerveau dans la maturation génitale et le déclenchement de l'épitoque chez les néréidiens. *Annls Sci. nat. (11^e sér.)*, **18**, 269-273.
- DURWOOD, M. D. and DOBKIN, S. (1975). A contribution to knowledge of the larval development of *Macrobrachium olfersii* (WIEGMANN, 1836) (Decapoda, Palaemonidae). *Crustaceana*, **29**, 1-30.

- DUTRIEU, J. (1960). Observations biochimiques et physiologiques sur le développement d'*Artemia salina* LEACH. *Archs Zool. exp. gén.*, **99**, 1-134.
- DYCHE, L. L. (1903). Notes on the food habits of California sea lions. *Trans. Kans. Acad. Sci.*, **18**, 179-182.
- DZWILLO, M. (1962). Domestikation bei Fischen. *Z. Tierzücht. ZüchtBiol.*, **77**, 172-185.
- EBERT, J. D. and SUSSEX, I. M. (1970). *Interacting Systems in Development*, Holt, Rinehart, and Winston, New York.
- EBERT, T. A. (1968). Growth rates of the sea urchin *Strongylocentrotus purpuratus* related to food availability and spine abrasion. *Ecology*, **49**, 1075-1091.
- ECKELBARGER, K. J. (1975). Developmental studies of the post-setting stages of *Sabellaria vulgaris* (Polychaeta: Sabellariidae). *Mar. Biol.*, **30**, 137-149.
- ECKERT, R. (1965). Bioelectric control of bioluminescence in the dinoflagellate *Noctiluca*. *Science, N.Y.*, **147**, 1140-1145.
- EDEL, R. K. (1975a). The induction of maturation of female American eels through hormone injections. *Helgoländer wiss. Meeresunters.*, **27**, 131-138.
- EDEL, R. K. (1975b). The effect of shelter availability on the activity of male silver eels. *Helgoländer wiss. Meeresunters.*, **27**, 167-174.
- EDMONDSON, C. H. (1946). Behavior of coral planulae under altered saline and thermal conditions. *Occ. Pap. Bernice P. Bishop Mus.*, **18**, 283-304.
- EDMONDSON, W. T. (1965). Reproductive rate of planktonic rotifers as related to food and temperature in nature. *Ecol. Monogr.*, **35**, 61-111.
- EFREMOVA, S. M. (1973). The sponges as object of experimental and morphological studies in France (Russ.). *Vest. leningr. gos. Univ.*, **9**, 7-19.
- EGAMI, N. (1951). A note on the sex-differentiation of the marine copepod *Tigriopus japonicus*. *Ann. Zool.*, **24**, 131-136.
- EGUSA, S. (1950). Some notes on the feeding habit of the young of *Mugil cephalus* L. (Jap.) *Bull. Jap. Soc. scient. Fish.*, **15**, 715-720.
- EHLERS, K. (1965). Records of the hooded seal, *Cystophora cristata* ERXL, and other animals at Bremerhaven Zoo. *Int. Zoo Yb.*, **5**, 148-149.
- EHRENBAUM, E. (1890). Zur Naturgeschichte von *Crangon vulgaris* FABR. *Dt. Seefischerei-Verein, Mitt. Sekt. Küsten-u. Hochseefisch.*, Berlin, 1-124.
- EHRENBAUM, E. (1903). Über den Hummer (Fang, Häutung, Wachstum, Vermehrung, künstliche Zucht). *Fischereizeitung, Neudamm*, **6**, 417-422, 433-436, 449-477.
- EHRENBAUM, E. (1910). Das Aquarium der Biologischen Anstalt auf Helgoland. *Intern. Rev. d. ges. Hydrogr. Hydrobiol.*, **3**, 418-446.
- EIBL-EIBESFELDT, I. (1962). Freiwasserbeobachtungen zur Deutung des Schwarmverhaltens verschiedener Fische. *Z. Tierphysiol. Tierernähr. Tiermittellk.*, **19**, 165-182.
- EICHEL, H. J., CONGER, N. and FIGUEROA, F. (1963). Extracellular ribonuclease of *Tetrahymena pyriformis* and comparison of its properties with the intracellular ribonuclease. *J. Protozool.*, **10** (Suppl.), 6.
- EICHELBAUM, E. (1910). Über Nahrung und Ernährungsorgane von Echinodermen. *Wiss. Meeresunters. Abt. Kiel*, **11**, 189-275.
- EICHELBERGER, L., FETCHER, E. S., GEILING, E. M. K. and VOS, B. J. (1940). The composition of dolphin milk. *J. biol. Chem.*, **134**, 171-176.
- EKMANN, S. (1925). Holothurien. *Further zool. Results Swed. Antarct. Exped.*, **1**, 1-194.
- ELBRÄCHTER, M. (1972). Begrenzte Heterotrophie bei *Amphidinium* (Dinoflagellata). *Kieler Meeresforsch.*, **28**, 84-91.
- ELMHIRST, R. (1922). Cyclic conditions and rejuvenation in hydroids. *Nature, Lond.*, **109**, 208-209.
- ELMHIRST, R. (1923). Notes on the breeding and growth of marine animals in the Clyde sea area. *Rep. Scott. mar. biol. Ass.*, **20**, 19-43.
- ELSNER, R. W. (1965). Heart heart response in forced versus trained experimental dives in pinnipeds. *Hvalråd. Skr.*, **48**, 24-29.
- EMLEN, J. M. (1966). The role of time and energy in food preference. *Am. Nat.*, **100**, 611-617.

- EMMERSON, W. (in press). Preliminary studies on feeding in penaeid prawn larvae using radiocarbon tracers. In G. Persoone and E. Jaspers (Eds), *Tenth European Marine Biology Symposium*. Ostend, Belgium, 1975.
- ENDERS, H. E. (1909). A study of the life history and habits of *Chaetopterus variopedatus*. *J. Morph.*, **20**, 479-531.
- ENDERS, R. K., PEARSON, O. P. and PEARSON, A. K. (1946). Certain aspects of reproduction in the fur seal. *Anat. Res.*, **94**, 213-223.
- EPIFANIO, C. E., LOGAN, C. M. and TURK, C. (in press). Culture of six species of bivalves in a recirculating seawater system. In G. Persoone and E. Jaspers (Eds), *Tenth European Marine Biology Symposium*. Ostend, Belgium, 1975.
- EPIFANIO, C. E. and MOOTZ, C. A. (in press). Growth of oysters in a recirculating maricultural system. *Proc. natn. Shellfish. Ass.*
- EPIFANIO, C. E., SENA, R. and PRUDER, G. (1975). Mariculture of shellfish in controlled environments: a prognosis. *Aquaculture*, **5**, 227-241.
- EPPLEY, R. W. and LASKER, R. (1959). Alginase in the sea urchin *Strongylocentrotus purpuratus*. *Science, N. Y.*, **129**, 214-215.
- ERMAN, L. A. (1962). Nutrition and reproduction of *Brachionus calyciflorus* PALL. Plankton rotifer in mass cultures. *Dokl. Akad. Nauk SSSR*, **114**, 926-929.
- ESCRITOR, G. L. (1970). A Report on Experiments in the Culture of the Mud crab (*Scylla serrata*). *Proc. Indo-Pacif. Fish. Coun., 14th Session*, Document IPFC/C70/Sym **46**.
- ETIENNE, N. (1959). Influence de la maturation sexuelle provoqué sur l'activité thyroïdienne de l'anguille européenne mâle, *Anguilla anguilla* L. *C.r. Séanc. Soc. Biol.*, **153**, 41-44.
- EVANS, F. R. (1958). Culture of Protozoa from Great Salt Lake. *J. Protozool.*, **5** (Suppl.), 13.
- EVANS, F. R. (1960). Studies on growth of Protozoa from Great Salt Lake with special reference to *Cristigera* sp. *J. Protozool.*, **7**, 14-15.
- EVANS, R. M. (1965). *The Chemistry of Antibiotics used in Medicine*, Pergamon Press, London.
- EWALD, J. J. (1965). The laboratory rearing of pink shrimp, *Penaeus duorarum* BURKENROAD. *Bull. mar. Sci.*, **15**, 436-449.
- FABRE-DOMERGUE, A. and BIÉTRIX, E. (1897). Recherches biologiques applicables à la pisciculture maritime sur les oeufs et les larves des poissons de mer et sur le turbot. *Annls Sci. nat. (Zool.)*, (8 Sér.), **4**, 151-220.
- FABRE-DOMERGUE, A. and BIÉTRIX, E. (1905). Développement de la Sole (*Solea vulgaris*). Introduction à l'étude de la pisciculture marine. *Travail du Laboratoire de Zoologie Maritime de Concarneau. Vuibert et Nony, Paris*.
- FAGERLUND, U. H. M. (1969). Lipid metabolism. In M. Florin and B. T. Schøer (Eds), *Chemical Zoology*, Vol. III. Academic Press, New York. pp. 123-134.
- FAHEY, W. E. (1963). A temperature-controlled salt-water circulating apparatus for developing fish eggs and larvae. *J. Cons. perm. int. Explor. Mer*, **28**, 364-384.
- FAIR, G. M., MORRIS, J. C., SHANG, S. L., WEIL, I. and BURDEN, P. (1948). The behavior of chlorine as a water disinfectant. *J. Am. Wat. Wks Ass.*, **40**, 1051-1061.
- FARMANFARMAIAN, A. (1963). Transport of nutrients in echinoderms. *Proc. Int. Congr. Zool.*, **16**, 118.
- FARMANFARMAIAN, A., GIESE, A. C., BOOLOOTIAN, R. A. and BENNETT, J. (1958). Annual reproductive cycles in four species of West Coast starfishes. *J. exp. Zool.*, **138**, 355-367.
- FARMANFARMAIAN, A. and PHILLIPS, J. (1962). Digestion, storage and translocation of nutrients in the purple sea urchin (*Strongylocentrotus purpuratus*). *Biol. Bull. mar. biol. Lab., Woods Hole*, **123**, 105-120.
- FAULKNER, G. H. (1931). Notes on the feeding mechanism and on intestinal respiration in *Chaetopterus variopedatus*. *Biol. Bull. mar. biol. Lab., Woods Hole*, **61**, 472-477.
- FAULKNER, L. R. and DARLING, H. M. (1961). Pathological histology, hosts, and culture of the potato rot nematode. *Phytopathology*, **51**, 778-786.
- FAXON, W. A. (1879). On the development of *Palaemonetes vulgaris*. *Bull. Mus. comp. Zool. Harv.*, **5**, 303-330.
- FAY, F. F. (1957). History and present status of the Pacific walrus population. *Trans. N. Am. Wildl. Conf.*, **22**, 431-445.

- FEDER, H. M. (1955). On the methods used by the starfish, *Pisaster ochraceus*, in opening three types of bivalve molluscs. *Ecology*, **36**, 764-767.
- FEDER, H. M. (1959). The food of the starfish, *Pisaster ochraceus*, along the California coast. *Ecology*, **40**, 721-724.
- FEDER, H. M. (1963). Gastropod defensive responses and their effectiveness in reducing predation by starfishes. *Ecology*, **44**, 505-512.
- FEDER, H. M. and ARVIDSSON, J. (1967). Studies on a sea-star (*Marthasterias glacialis*) extract responsible for avoidance reactions in a gastropod (*Buccinum undatum*). *Ark. Zool. (Ser. 2)*, **19**, 369-379.
- FEDER, H. M. and CHRISTENSEN, A. M. (1966). Aspects of asteroid biology. In R. A. Boolootian (Ed.), *Physiology of Echinodermata*. Interscience, New York. pp. 87-127.
- FELL, H. B. (1941). The direct development of a New Zealand ophiuroid. *Q. Jl microsc. Sci.*, **82**, 377-441.
- FELL, H. B. (1953). Echinoderms from the subantarctic islands of New Zealand: Asteroidea, Ophiuroidea, and Echinoidea. *Rec. Dom. Mus., Wellington*, **2**, 73-111.
- FELL, H. B. (1966a). Ecology of erinoids. In R. A. Boolootian (Ed.), *Physiology of Echinodermata*. Interscience, New York. pp. 49-62.
- FELL, H. B. (1966b). The ecology of ophiuroids. In R. A. Boolootian (Ed.), *Physiology of Echinodermata*. Interscience, New York. pp. 129-143.
- FELTS, W. J. L. (1966). Discussion remarks to 'Round Table: Practical Problems'. In K. S. Norris (Ed.), *Whales, Dolphins, and Porpoises*. University of California Press, Berkeley. p. 652.
- FENCHEL, T. (1965). Feeding biology of the sea-star *Luidia sarsi* DÜBEN & KOREN. *Ophelia*, **2**, 223-236.
- FENCHEL, T. (1968). The ecology of marine microbenthos. III. The reproductive potential of ciliates. *Ophelia*, **5**, 123-136.
- FERGUSON, J. C. (1967a). Utilization of dissolved exogenous nutrients by the starfishes *Asterias forbesi* and *Henricia sanguinolenta*. *Biol. Bull. mar. biol. Lab., Woods Hole*, **132**, 161-173.
- FERGUSON, J. C. (1967b). An autoradiographic study of the utilization of free exogenous amino acids by starfishes. *Biol. Bull. mar. biol. Lab., Woods Hole*, **133**, 317-329.
- FERGUSON, J. C. (1969a). Feeding activity of *Echinaster* and its induction by dissolved elements. *Biol. Bull. mar. biol. Lab., Woods Hole*, **136**, 374-384.
- FERGUSON, J. C. (1969b). Feeding, digestion, and nutrition in Echinodermata. In M. Florkin and B. T. Scheer (Eds), *Chemical Zoology*. Academic Press, New York. pp. 71-100.
- FERGUSON, J. C. (1970). An autoradiographic study of the translocation and utilization of amino acids by starfish. *Biol. Bull. mar. biol. Lab., Woods Hole*, **138**, 14-25.
- FERGUSON, J. C. (1971). Uptake and release of free amino acids by starfishes. *Biol. Bull. mar. biol. Lab., Woods Hole*, **141**, 122-129.
- FIELD, G. A. (1922). Biology and economic value of the sea mussel *Mytilus edulis*. *Bull. U.S. Bur. Fish.*, **38**, 127-259.
- FIELDER, D. R. (1964). The spiny lobster, *Jasus lalandei* (H. MILNE EDWARDS) in South Australia. Growth of captive animals. *Aust. J. mar. Freshwat. Res.*, **15**, 77-92.
- FIELDER, D. R. (1970). The larval development of *Macrobrachium australiense* HOLTHUIS, 1950 (Decapoda, Palaemonidae), reared in the laboratory. *Crustaceana*, **18**, 60-74.
- FIGUEIREDO, M. J. DE and VILELA, M. H. (1972). On the artificial culture of *Nephrops norvegicus* reared from the egg. *Aquaculture*, **1**, 173-180.
- FISCHER, A. (1965). Über die Chromatophoren und den Farbwechsel bei dem Polychäten *Platynereis dumerilii*. *Z. Zellforsch. mikrosk. Anat.*, **65**, 290-312.
- FISCHER, A. (1969). Eine Pigmentmangelmutante bei dem Polychaeten *Platynereis dumerilii*. *Molec. Gen. Genetics.*, **104**, 360-370.
- FISCUS, C. H. and BAINES, G. A. (1966). Food and feeding behavior of Steller and California sea lions. *J. Mammal.*, **47**, 195-200.
- FISCUS, C. H. and KAJIMURA, H. (1967). Pelagic fur seal investigations, 1966. *Manuscript Rep. Marine Mammal Biol. Lab., Seattle, Bur. Comm. Fish.*, 1967, 170-231.
- FISH, J. D. (1967). The biology of *Crucumaria elongata* (Echinodermata: Holothuroidea). *J. mar. biol. Ass. U.K.*, **47**, 129-143.

- FISHELSON, L. (1963). Observations on littoral fishes of Israel. II. Larval development and metamorphosis of *Blennius pavo* RISSO (Teleostei, Blenniidae). *Israel J. Zool.*, **12**, 81-91.
- FISHER, H. D. (1952). The status of the harbour seal in British Columbia, with particular reference to the Skeena River. *Bull. Fish. Res. Bd Can.*, **93**, 1-58.
- FISHER, H. D. (1954). Delayed implantation in the harbour seal, *Phoca vitulina* L. *Nature, Lond.*, **173**, 879-880.
- FISHER, H. D. and HARRISON, R. J. (1970). Reproduction in the common porpoise (*Phocoena phocoena*) of the North Atlantic. *J. Zool., Lond.*, **161**, 471-486.
- FISHER, H. D. and MACKENZIE, B. A. (1955). Food habits of seals in the Maritimes. *Fish. Res. Bd Can., Prog. Rep. Atlantic Coast Sta.*, **61**, 5-9.
- FISHER, W. K. (1911). Asteroidea of the North Pacific and adjacent waters. *Bull. U.S. natn. Mus.*, **76**, 1-419.
- FISHER, W. K. (1917). *Trophodiscus*, a new sea star from Kamchatka. *Proc. U.S. natn. Mus.*, **52**, 367-371.
- FISHER, W. K. (1928a). Asteroidea of the North Pacific and adjacent waters. *Bull. U.S. natn. Mus.*, **76**, 1-245.
- FISHER, W. K. (1928b). Starfish from the Arcturus oceanographic expedition. *Zoologica, N.Y.*, **8**, 487-493.
- FISHER, W. K. (1930). Asteroidea of the North Pacific and adjacent waters. Part 3. Forcipulata (concluded). *Bull. U.S. natn. Mus.*, **76**, 1-390.
- FISHER, W. K. (1940). Asteroidea. 'Discovery' Rep., **20**, 69-306.
- FITZGERALD, G. P. (1959). Bactericidal and algicidal properties of some algicides for swimming pools. *Appl. Microbiol.*, **7**, 205-211.
- FLÜCHTER, J. (1965). Versuche zur Brutaufzucht der Seeszunge *Solea solea* in kleinen Aquarien. *Helgoländer wiss. Meeresunters.*, **12**, 395-403.
- FLÜCHTER, J. (1974). Laboratory rearing of common sole (*Solea solea* L.) under controlled conditions at high density with low mortality. In J. H. S. Blaxter (Ed.), *The Early Life History of Fish*. Springer-Verlag, Berlin. pp. 725-730.
- FLÜCHTER, J. and TROMMSDORFF, H. (1974). Nutritive stimulation of spawning in common sole (*Solea solea* L.). *Ber. dt. wiss. Kommn Meeresforsch.*, **23**, 352-359.
- FØYEN, B. (1927a). Studien über Geschlecht und Geschlechtszellen bei Hydroiden. I. Ist *Clava squamata* (MÜLLER) eine gonochoristische oder hermaphrodite Art? *Wilhelm Roux Arch. Entw.Mech. Org.*, **109**, 513-534.
- FØYEN, B. (1927b). Studien über Geschlecht und Geschlechtszellen bei Hydroiden. II. Auspressungsversuche an *Clava squamata* (MÜLLER) mit Mischung von Zellen aus Polyphen desselben oder verschiedenen Geschlechts. *Wilhelm Roux Arch. Entw.Mech. Org.*, **110**, 89-148.
- FØYEN, B. and GJØEN, I. (1954a). Studies on the serpulid *Pomatoceros triqueter* L. I. Observations on the life history. *Nytt Mag. Zool.*, **2**, 73-81.
- FØYEN, B. and GJØEN, I. (1954b). Studies on the serpulid *Pomatoceros triqueter* L. II. The colour pattern of the branchial crown and its inheritance. *Nytt Mag. Zool.*, **2**, 85-90.
- FOGG, G. E. (1972). Organic substances: Plants. In O. Kinne (Ed.), *Marine Ecology*, Vol. I, Environmental Factors, Part 3. Wiley, London, pp. 1551-1577.
- FOL, H. (1877). Sur le commencement de l'hénogénie chez divers animaux. *Archs Zool. exp. gén.*, **6**, 145-169.
- FOL, H. (1879). Recherches sur la fécondation et le commencement de l'hénogénie chez divers animaux. *Mém. Soc. Phys. Hist. nat. Genève*, **26**, 89-397.
- FONTAINE, A. R. (1965). The feeding mechanisms of the ophiuroid *Ophiocomina nigra*. *J. mar. biol. Ass. U.K.*, **45**, 373-385.
- FONTAINE, M. (1936). Sur la maturation complète des organes génitaux de l'anguille mâle et l'émission spontanée. *C.r. hebd. Séanc. Acad. Sci., Paris*, **202**, 1312-1314.
- FONTAINE, M. (1961). L'Anguille européenne succombe-t-elle sans se reproduire? *C.r. hebd. Séanc. Acad. Sci., Paris*, **252**, 1258-1260.
- FONTAINE, M. (1976). Hormones and the control of reproduction in aquaculture. *J. Fish. Res. Bd Can.*, **33**, 922-939.

- FONTAINE, M., BERTRAND, E., LOPEZ, E. and CALLAMAND, O. (1964). Sur la maturation des organes génitaux de l'Anguille femelle (*Anguilla anguilla* L.) et l'émission spontanée des oeufs en aquarium. *C.r. hebd. Séanc. Acad. Sci., Paris*, **259**, 2907-2910.
- FORBES, L., SEWARD, M. J. B. and CRISP, D. J. (1971). Orientation to light and the shading response in barnacles. In D. J. Crisp (Ed.), *Fourth European Marine Biology Symposium*. Cambridge University Press, London. pp. 539-558.
- FORD, T. B. and ST. AMANT, L. S. (1971). Management guidelines for predicting brown shrimp, *Penaeus aztecus*, production in Louisiana. *Proc. Gulf Caribb. Fish. Inst.*, **23**, 149-161.
- FORDHAM, M. G. C. (1925). *Aphrodite aculeata*. In W. A. Herdman and J. Johnstone (Eds), *L.M.B.C. Memoirs, XXVII*. University Press of Liverpool, Liverpool. pp. 1-96.
- FORRESTER, C. R. (1964). Laboratory observations on embryonic development and larvae of the Pacific cod (*Gadus macrocephalus* TILESIIUS). *J. Fish. Res. Bd Can.*, **21**, 9-16.
- FORSS, C. A. and COFFIN, H. G. (1960). The use of the brine shrimp nauplii, *Artemia salina*, as food for the laboratory culture of decapods. *Walla Walla Coll. Publs Dep. biol. Sci.*, **26**, 1-17.
- FORSTER, J. R. M. (1970). Studies on the development of a compounded diet for prawns with particular reference to *Palaemon serratus* P. Ph.D. Thesis, University of Wales.
- FORSTER, J. R. M. (1972). Some methods of binding prawn diets and their effects on growth and assimilation. *J. Cons. int. Explor. Mer*, **34**, 200-216.
- FORSTER, J. R. M. and BEARD, T. W. (1969). Some experiments on the preparation of a compounded diet for the prawn *Palaemon serratus* PENNANT. *Count. Meet. int. Coun. Explor. Sea (C.M.-I.C.E.S.)*, **E. 6**.
- FORSTER, J. R. M. and BEARD, T. W. (1973). Growth experiments with the prawn *Palaemon serratus* PENNANT fed with fresh and compounded foods. *Fishery Invest., Lond.* (Ser. 2), **27**, 1-16.
- FOWLER, S. W. and BENAYOUN, G. (1976). Influence of environmental factors on selenium flux in two marine invertebrates. *Mar. Biol.*, **37**, 59-68.
- FOX, H. M. (1924a). Lunar periodicity in reproduction. *Proc. R. ent. Soc. Lond.* (Ser. B), **95**, 523-550.
- FOX, H. M. (1924b). The spawning of echinoids. *Proc. Camb. phil. Soc. biol. Sci.*, **1**, 71-74.
- FOXTON, P. (1964). Observations on the early development and hatching of the eggs of *Acanthephyra purpurea* A. MILNE EDWARDS. *Crustaceana*, **6**, 235-237.
- FRANK, J. R., SULKIN, S. D. and MORGAN, R. P., II. (1975). Biochemical changes during larval development of the xanthid crab *Rhithropanopeus harrisi*. I. Protein, total lipid, alkaline phosphatase, and glutamic oxaloacetic transaminase. *Mar. Biol.*, **32**, 105-111.
- FRANKENBERG, D. and SMITH, K. L., JR. (1967). Coprophagy in marine animals. *Limnol. Oceanogr.* **12**, 443-450.
- FRANKLAND and HAMBLY (1890). (Quoted in ARVY, 1973-1974.)
- FRASER, J. H. (1936). The occurrence, ecology and life history of *Tigriopus fulvus* (FISCHER). *J. mar. biol. Ass. U.K.*, **20**, 532-536.
- FRASER, L. C. (1936). On the development and distribution of the young stages of the krill (*Euphausia superba*). 'Discovery' Rep., **14**, 1-192.
- FREIBERGER, A. and COLOGER, C. P. (1966). Rearing acorn barnacles in the laboratory for marine fouling studies. *J. Am. Soc. nav. Engrs*, **78**, 881-890.
- FRETTER, V. (1967). The prosobranch veliger. *Proc. malac. Soc. Lond.*, **37**, 357-366.
- FRETTER, V. and MONTGOMERY, M. C. (1968). The treatment of food by prosobranch veligers. *J. mar. biol. Ass. U.K.*, **48**, 499-520.
- FREUDENTHAL, H. D., LEE, J. J. and PIERCE, S. (1963). Growth and physiology of Foraminifera in the laboratory. II. A tidal system for laboratory studies on eulittoral Foraminifera. *Micropaleontology*, **9**, 443-448.
- FRICKE, H. W. (1974). Möglicher Einfluß von Feinden auf das Verhalten von *Diadema*-Seeigeln. *Mar. Biol.*, **27**, 59-62.
- FRIEDL, H. (1925). Koloniebildung, Besiedlung und Wachstum bei marinen Bryozoen. *Arb. zool. Inst. Univ. Innsbruck*, **2**, 139-168.
- FRIEDMAN, L. and SHIBKO, S. I. (1972). Nonnutrient components of the diet. In J. E. Halver (Ed.), *Fish Nutrition*. Academic Press, New York. pp. 181-254.

- FROSCH, P. (1897). Zur Frage der Reinzüchtung der Amöben. *Zentbl. Bakt. ParasitKde*, (I), **21**, 926-932.
- FRY, W. G. (Ed.) (1970). The biology of the Porifera. *Symp. zool. Soc. Lond.*, **25**, 1-512.
- FRY, W. G. (1971). The biology of larvae of *Ophlitaspongia seriata* from two North Wales populations. In J. C. Crisp (Ed.), *Fourth European Marine Biology Symposium*. Cambridge University Press, Cambridge. pp. 155-178.
- FÜLLER, H. (1961). Annelida-Ringelwürmer. In E. Stresemann (Ed.), *Exkursionsfauna von Deutschland, Wirbellose I* Volks und Wissen. VEB, Berlin. pp. 235-289.
- FUJI, A. (1960). Studies on the biology of the sea urchin. III. Reproductive cycle of two sea urchins, *Strongylocentrotus nudus* and *S. intermedius*, in southern Hokkaido. *Bull. Fac. Fish. Hokkaido Univ.*, **11**, 49-57.
- FUJI, A. (1962). Studies on the biology of the sea urchin. V. Food consumption of *Strongylocentrotus intermedius*. *Jap. J. Ecol.*, **12**, 181-186.
- FUJI, A. (1963). On the growth of the sea urchin, *Hemicentrotus pulcherrimus* (A. AGASSIZ). *Bull. Jap. Soc. scient. Fish.*, **29**, 118-126.
- FUJI, A. (1967). Ecological studies on the growth and food consumption of Japanese common littoral sea urchin, *Strongylocentrotus intermedius* (A. AGASSIZ). *Bull. Fac. Fish. Hokkaido Univ.*, **15**, 83-160.
- FUJIMURA, T. (1966). Notes on the development of a practical mass culturing technique of the giant prawn *Macrobrachium rosenbergi*. *Work Paper of the Indo-Pacific Fisheries Council IPFC/C 66/WP (47)*.
- FUJINAGA, M. (1963). Culture of Kuruma-shrimp (*Penaeus japonicus*). *Curr. Aff. Bull. Indo-Pacif. Fish. Council.*, **36**, 10-11.
- FUJINAGA, M. (1969). Kuruma shrimp (*Penaeus japonicus*) cultivated in Japan. *F.A.O. Fish. Rep.*, **57**, 811-832.
- FUJITA, A. (1954). Thiaminase. *Adv. Enzymol.*, **15**, 389-421.
- FUJITA, S. (1965). Early development and rearing of two common flatfishes, *Eopsetta grigorjewi* (HERZENSTEIN) and *Tanakius kitaharai* (JORDAN et STARKS). (Jap.) *Bull. Jap. Soc. scient. Fish.*, **31**, 258-262.
- FUJITA, S. (1966). Egg development, larval stages, and rearing of the puffer, *Lagocephalus lunaris spadiceus* (RICHARDSON). (Jap.) *Jap. J. Ichthyol.*, **13**, 162-168.
- FUJITA, S. and UENO, M. (1954). On the development of the egg and prelarval stages of *Siganus fuscus* (HOULTUYN) by artificial insemination. *Jap. J. Ichthyol.*, **3**, 129-132.
- FUJIYA, M. (1970). Oyster farming in Japan. *Helgoländer wiss. Meeresunters.* **20**, 464-479.
- FULLER, J. L. (1937). Feeding rate of *Calanus finmarchicus* in relation to environmental conditions. *Biol. Bull. mar. biol. Lab., Woods Hole*, **72**, 233-246.
- FULTON, C. (1960). Culture of a colonial hydroid under controlled conditions. *Science, N.Y.*, **132**, 473-474.
- FULTON, C. (1962). Environmental factors influencing the growth of *Cordylophora*. *J. exp. Zool.*, **151**, 61-78.
- FULTON, C. (1963a). The development of a hydroid colony. *Devl Biol.*, **6**, 333-369.
- FULTON, C. (1963b). Rhythmic movements in *Cordylophora*. *J. cell. comp. Physiol.*, **61**, 39-52.
- FURUKAWA, I. (1972). Larval culture of the penaeid prawn, *Penaeus japonicus*, fed marine yeast. (Jap.) *Yooshoku*, **105**, 38-42.
- FURUKAWA, I. and HIDAKA, T. (1972). Mass-culture of marine rotifer, *Brachionus plicatilis*, fed the marine yeast. Oral presentation in the Spring Meeting of Japan. Soc. Sci. Fish.
- FURUKAWA, I. and HIDAKA, T. (1973). Technical problems encountered in the mass culture of rotifer using marine yeast as food organisms. *Bull. Plankton Soc. Japan*, **20**, 61-71.
- FUSELER, J. W. (1973). Repetitive procurement of mature gametes from individual sea stars and sea urchins. *J. Cell. Biol.*, **57**, 879-881.
- GABBOTT, P. A., JONES, D. A. and NICHOLS, D. H. (in press). Studies on the design and acceptability of micro-encapsulated diets for marine particle feeders. II. Bivalve molluscs. *Tenth European Marine Biology Symposium*. Ostend, Belgium, 1975.
- GALE, E. F. (1966). The object of the exercise. 16th Symposium of General Microbiology, Vol. 16, *Biochemical Studies of Antimicrobial Drugs*. Cambridge University Press, Cambridge. pp. 1-21.

- GALTSOFF, P. S. (1923). Amoeboid movement of dissociated sponge cells. *Biol. Bull. mar. biol. Lab., Woods Hole*, **45**, 153-161.
- GALTSOFF, P. S. (1925). Regeneration after dissociation. (An experimental study on sponges.) I. Behaviour of dissociated cells of *Microciona prolifera* under normal and altered conditions. *J. exp. Zool.*, **42**, 183-222.
- GALTSOFF, P. S. (1929). Heteroagglutination of dissociated sponge cells. *Biol. Bull. mar. biol. Lab., Woods Hole*, **57**, 250-260.
- GALTSOFF, P. S. (1930). The fecundity of the oyster. *Science, N. Y.*, **72**, 97-98.
- GALTSOFF, P. S. (1932). Spawning reactions of three species of oysters. *J. Wash. Acad. Sci.*, **22**, 65-69.
- GALTSOFF, P. S. (1937). Hatching and rearing larvae of the American lobster, *Homarus americanus*. In J. G. Needham (Ed.), *Culture Methods for Invertebrate Animals*. Comstock Publishing Company, New York. pp. 233-236.
- GALTSOFF, P. S. (1938). Physiology of reproduction of *Ostrea virginica*. I. Spawning reactions of the female and male. *Biol. Bull. mar. biol. Lab., Woods Hole*, **74**, 461.
- GALTSOFF, P. S. (1940). Physiology of reproduction of *Ostrea virginica*. III. Stimulation of spawning in the male oyster. *Biol. Bull. mar. biol. Lab., Woods Hole*, **78**, 117-135.
- GALTSOFF, P. S. (1964). The American oyster *Crassostrea virginica* GMELIN. *Fishery Bull. Fish Wildl. Serv. U.S.*, **64**, 1-480.
- GALTSOFF, P. S. (1972). *Bibliography of Oysters and Other Marine Organisms Associated with Oyster Bottoms and Estuarine Ecology*, Hall, Boston.
- GALTSOFF, P. S. and LOOSANOFF, V. L. (1939). Natural history and method of controlling the starfish (*Asterias forbesi*). *Bull. Bur. Fish., Wash.*, **49**, 73-132.
- GALTSOFF, P. S. and PERTZOFF, V. (1926). Some physiochemical properties of dissociate sponge cells. *J. gen. Physiol.*, **10**, 239-255.
- GARBER, B. I. (1939). Studies on the development and reproduction of *Calanipeda aquae-dulcis*. (Russ.) Ph.D. Thesis, University of Moscow.
- GARROD, L. P. and O'GRADY, F. (1968). *Antibiotic and Chemotherapy*, E. & S. Livingstone Ltd., Edinburgh.
- GARSIDE, E. T. (1959). Some effects of oxygen in relation to temperature on the development of lake trout embryos. *Can. J. Zool.*, **37**, 689-698.
- GARSIDE, E. T. (1960). Some aspects of the developmental rate and meristic numbers in salmonids. Ph.D. Thesis, University of Toronto.
- GARSIDE, E. T. (1970). Temperature: Animals. Invertebrates—Structural responses. In O. Kinne (Ed.), *Marine Ecology*, Vol. I, Environmental Factors, Part 1. Wiley, London. pp. 561-573.
- GARSTANG, W. (1900). Preliminary experiments on the rearing of sea-fish larvae. *J. mar. biol. Ass. U.K.*, **6**, 70-93.
- GASKIN, D. E. and CAWTHORN, M. W. (1967). Diet and feeding habits of the sperm whale (*Physeter catodon* L.) in the Cook Strait Region of New Zealand. *N.Z. Jl mar. freshw. Res.*, **1**, 156-179.
- GAUDENZI, B. and ZUNARELLI, R. (1960). Influenza di fattori ambientali nella produzione di femmine mittiche e di maschi in due specie di *Brachionus*. *Archo zool. ital.*, **45**, 159-163.
- GAUDY, R. (1971). Étude expérimentale de la ponte chez trois espèces de copépodes pélagiques (*Centropages typicus*, *Acartia clausi* et *Temora stylifera*). *Mar. Biol.*, **9**, 65-70.
- GAUDY, R. (1974). Feeding four species of pelagic copepods under experimental conditions. *Mar. Biol.*, **25**, 125-141.
- GAULD, D. T. (1951). The grazing rate of planktonic copepods. *J. mar. biol. Ass. U.K.*, **29**, 695-706.
- GAULD, D. T. (1959). Swimming and feeding in crustacean larvae: the nauplius larvae. *Proc. zool. Soc. Lond.*, **132**, 31-50.
- GAUSE, G. F. (1934). Eksperimental'noe issledovanie bor' sa suchestvovovanie mesdu *Paramecium caudatum*, *Paramecium aurelia*, i *Stylomychia mytilus*. *Zool. Zh.*, **13**, 1-17.
- GAYLORD, H. R., MARSH, M. C., BUSCH, F. C. and SIMPSON, B. (1914). Carcinoma of the thyroid in the salmonid fishes. *Bull. U.S. Bur. Fish.*, **32**, 363-524.
- GEMMILL, J. F. (1914). The development and certain points in the adult structure of *Asterias rubens*. *Phil. Trans. R. Soc. (Ser. B)*, **205**, 213-294.

- GEMMILL, J. F. (1915). On the ciliation of asterids, and on the question of ciliary nutrition in certain species. *Proc. zool. Soc. Lond.*, **1**, 1-19.
- GEMMILL, J. F. (1920). The development of the sea-anemones *Metridium dianthus* (ELLIS) and *Adamsia palliata* (BOHAD). *Phil. Trans. R. Soc. (Ser. B)*, **209**, 351-375.
- GEORGE, J. D. (1971). The effects of pollution by oil and oil dispersants on the common intertidal polychaetes, *Cirriformia tentaculata* and *Cirratulus cirratus*. *J. appl. Ecol.*, **8**, 411-420.
- GEORGE, J. D. (in press). The mass culture of benthic polychaetes and harpacticoid copepods in agar. In G. Persoone and E. Jaspers (Eds), *Tenth European Marine Biology Symposium*. Ostend, Belgium, 1975.
- GEORGE, M. J. (1970a). Synopsis of biological data on the penaeid prawn *Metapenaeus dobsoni* (MIERS, 1878). *F.A.O. Fish. Rep.*, **57**, 1335-1357.
- GEORGE, M. J. (1970b). Synopsis of biological data on the penaeid prawn *Metapenaeus affinis* (H. MILNE EDWARDS, 1837). *F.A.O. Fish. Rep.*, **57**, 1359-1375.
- GEORGE, M. J. (1970c). Synopsis of biological data on the penaeid prawn *Metapenaeus monoceros* (FABRICIUS, 1798). *F.A.O. Fish. Rep.*, **57**, 1539-1557.
- GEORGE, M. J. (1970d). Synopsis of biological data on the penaeid prawn *Metapenaeus brevicornis* (H. MILNE EDWARDS, 1837). *F.A.O. Fish. Rep.*, **57**, 1559-1573.
- GERACI, J. R. (1968). Diet-induced thiamine deficiency in captive marine mammals. In D. K. Caldwell and M. C. Caldwell (Eds), *Diseases and Husbandry of Aquatic Mammals*. Proc. 2nd Symp., Fla. Atl. Univ., Boca Raton, Florida.
- GERACI, J. R. (1972a). Experimental thiamine deficiency in captive harp seals (*Phoca groenlandica*) induced by eating herring, *Clupea harengus*, and smelts, *Osmerus mordax*. *Can. J. Zool.*, **50**, 179-195.
- GERACI, J. R. (1972b). Hyponatremia and the need for dietary salt supplementation in captive pinnipeds. *J. Am. vet. Radiol. Soc.*, **161**, 618-623.
- GERACI, J. R. (1975). Pinniped nutrition. *Rapp. P.-v. Réun. Cons. int. Explor. Mer*, **169**, 312-323.
- GERACI, J. R. and GERSTMANN, K. E. (1966). Relationship of dietary histamine to gastric ulcers in the dolphin. *J. Am. vet. med. Ass.*, **149**, 884-890.
- GERARD, R. D. and ROELS, O. A. (1970). Deep ocean water as a resource for combined mariculture, power and fresh water production. *Mar. Technol. Soc. J.*, **4**, 69-78.
- GERASIMOV, V. V. (1962). Feeding behavior of Murmansk herring in and outside the school in aquarium conditions. *Trudy murmansk. biol. Inst.*, **4**, 254-259.
- GERASIMOV, V. V. (1965). *Role of the Imitating Reflexes in the Schooling Behavior of Fish*, Nauka Publishing House, Moscow.
- GERLACH, S. A. and RIEMANN, F. (1973). The Bremerhaven checklist of aquatic nematodes. *Veröff. Inst. Meeresforsch. Bremerh.*, **4** (Suppl.), 1-404.
- GERLACH, S. A. and RIEMANN, F. (1974). The Bremerhaven checklist of aquatic nematodes. *Veröff. Inst. Meeresforsch. Bremerh.*, **4** (Suppl.), 405-734.
- GERLACH, S. A. and SCHRAGE, M. (1969). Freilebende Nematoden als Nahrung der Sandgarnele *Crangon crangon*. Experimentelle Untersuchungen über die Bedeutung der Meiofauna als Nahrung für das marine Makrobenthos. *Oecologia*, **2**, 362-375.
- GERLACH, S. A. and SCHRAGE, M. (1971). Life cycles in marine meiobenthos. Experiments at various temperatures with *Monhystera disjuncta* and *Theristus pertenuis* (Nematoda). *Mar. Biol.*, **9**, 274-280.
- GERLACH, S. A. and SCHRAGE, M. (1972). Life cycles at low temperatures in some free-living marine nematodes. *Veröff. Inst. Meeresforsch. Bremerh.*, **14**, 5-11.
- GEWALT, W. (1965). Dolphin exhibit at Duisburg Zoo. *Int. Zoo Yb.*, **7**, 61-62.
- GEWALT, W. (1967). Über den Beluga-Wal *Delphinapterus leucas* (PALLAS, 1776) im Rhein bei Duisburg. *Z. Säugetierk.*, **32**, 65-86.
- GEWALT, W. (1969). Erste Duisburger Delphinerfahrungen an *Tursiops truncatus* MONT. *Zool. Gart., Frankf.*, **36**, 268-311.
- GEWALT, W. (1970). Unsere Weisswal (*Delphinapterus leucas* PALL.)—Expedition 1969. *Zool. Gart., Frankf.*, **38**, 187-226.
- GEWALT, W. (1971). White whales *Delphinapterus leucas* at Duisburg Zoo. *Int. Zoo Yb.*, **11**, 204-205.

- GEWALT, W. (1973). Tiergärtnerische Reiseeindrücke aus Japan. *Zool. Gart., Frankf.*, **43**, 1-47.
- GEWALT, W. and HABERKORN, E.-D. (1970). The new dolphin exhibit at Duisburg Zoo. *Int. Zoo Yb.*, **10**, 47-49.
- GIBBNEY, L. F. (1957). The seasonal reproductive cycle of the female elephant seal *Mirounga leonina* LINN., at Heard Island. *A.N.A.R.E. Rep.* (Series B), **1**, 1-26.
- GIBSON, G. G. and LUND, D. S. (1973). A pilot economic study of oyster raft culture in Yaquina Bay. *Proc. natn. Shellfish. Ass.*, **63**, 7.
- GIESE, A. C. (1966). Die Embryonalentwicklung von *Monocelis fusca* OERSTED (Turbellaria, Proseriata). *Z. Morph. Tiere*, **57**, 137-230.
- GIESE, A. C. (1959). Comparative physiology: annual reproductive cycles of marine invertebrates. *A. Rev. Physiol.*, **21**, 547-576.
- GIESE, A. C. (1961). Further studies on *Allocentrotus fragilis*, a deep-sea echinoid. *Biol. Bull. mar. biol. Lab., Woods Hole*, **121**, 141-150.
- GIESE, A. C. (1966). On the biochemical constitution of some echinoderms. In R. A. Boolootian (Ed.), *Physiology of Echinodermata*. Interscience, New York. pp. 757-796.
- GIESE, A. C., GREENFIELD, L., HUANG, H., FARMANFARMAIAN, A., BOOLOOTIAN, R. and LASKER, R. (1958). Organic productivity in the reproductive cycle of the purple sea urchin. *Biol. Bull. mar. biol. Lab., Woods Hole*, **116**, 49-58.
- GIHR, M., KRAUS, C. and PILLERI, G. (1972). Meteorological influences on the daily feeding rate of the Indus dolphin, *Platanista indi*, in captivity. In G. Pilleri (Ed.), *Investigations on Cetacea*, Vol. IV. Prof. G. Pilleri, Waldau-Berne. pp. 34-43.
- GILAT, E. (1967). On the feeding of a benthonic copepod *Tigriopus brevicornis* O. F. MÜLLER. *Bull. Sea Fish. Res. Stn. Israel*, **45**, 79-95.
- GILBERT, J. J. (1963). Mictic female production in the rotifer *Brachionus calyciflorus*. *J. exp. Zool.*, **153**, 113-123.
- GILBERT, J. J. (1968). Dietary control of sexuality in the rotifer *Asplanchna brightwelli* GOSSE. *Physiol. Zool.*, **41**, 14-43.
- GILBERT, J. J. (1970). Monoxenic cultivation of the rotifer *Brachionus calyciflorus* in a defined medium. *Oecologia*, **4**, 89-101.
- GILBERT, J. J. (1971). Some notes on the control of sexuality in the rotifer *Asplanchna sieboldi*. *Limnol. Oceanogr.*, **16**, 309-319.
- GILCHRIST, B. M. (1954). Haemoglobin in *Artemia*. *Proc. R. Soc.* (Series B), **43**, 136-146.
- GILLET, D. and GUERIN, J. P. (in press). Étude de la production de *Tisbe holothuriae* (Copepode Harpacticoide) dans diverses conditions d'élevages. In G. Persoone and E. Jaspers (Eds), *Tenth European Marine Biology Symposium*. Ostend, Belgium, 1975.
- GILPIN-BROWN, J. B. (1959). The reproduction and larval development of *Nereis fucata* (SAVIGNY). *J. mar. biol. Ass. U.K.*, **38**, 65-80.
- GILPIN-BROWN, J. B. (1969). Host-adoption in the commensal polychaete *Nereis fucata*. *J. mar. biol. Ass. U.K.*, **49**, 121-127.
- GIRIN, M. (in press). La ration alimentaire dans l'élevage larvaire du bar (*Dicentrarchus labrax* (L.)). In G. Persoone and E. Jaspers (Eds), *Tenth European Marine Biology Symposium*. Ostend, Belgium, 1975.
- GIRSA, I. I. (1962). On the decrease in availability of small fish to predators in connection with the formation of sensitive conditional reflexes. *Vop. Ikhtiol.*, **2**, 747-749.
- GISLÉN, T. (1924). Echinoderm studies. *Zool. Bidr. Upps.*, **9**, 1-316.
- GLYNN, P. W. (1973). *Acanthaster*: effect on coral reef growth in Panama. *Science, N. Y.*, **180**, 504-506.
- GOERKE, H. (1966). Nahrungsfiltration von *Nereis diversicolor* O. F. MÜLLER (Nereidae, Polychaeta). *Veröff. Inst. Meeresforsch. Bremerh.*, **10**, 49-58.
- GOERKE, H. (1971a). Die Ernährungsweise der *Nereis*-Arten (Polychaeta, Nereidae) der deutschen Küsten. *Veröff. Inst. Meeresforsch. Bremerh.*, **13**, 1-50.
- GOERKE, H. (1971b). Nahrungsaufnahme, Nahrungsausnutzung und Wachstum von *Nereis virens* (Polychaeta, Nereidae). *Veröff. Inst. Meeresforsch. Bremerh.*, **13**, 51-78.
- GOERKE, H. (1971c). *Nereis fucata* (Polychaeta, Nereidae) als Kommensale von *Eupagurus bernhardus* (Crustacea, Paguridae). Entwicklung einer Population und Verhalten. *Veröff. Inst. Meeresforsch. Bremerh.*, **13**, 79-118.

- GOLD, K. (1964). A microbiological assay for vitamin B₁₂ in sea water using radiocarbon. *Limnol. Oceanogr.*, **9**, 343-347.
- GOLD, K. (1968). Some observations on the biology of *Tintinnopsis* sp. *J. Protozool.*, **15**, 193-194.
- GOLD, K. (1969a). The preservation of tintinnids. *J. Protozool.*, **16**, 126-128.
- GOLD, K. (1969b). Tintinnida: feeding experiments and lorica development. *J. Protozool.*, **16**, 507-509.
- GOLD, K. (1970). Cultivation of marine ciliates (Tintinnida) and heterotrophic flagellates. *Helgoländer wiss. Meeresunters.*, **20**, 264-271.
- GOLD, K. (1971a). Observations on anisogamous conjugation in cultures of *Tintinnopsis beroidea* (Tintinnida). *J. Protozool.*, **18** (Suppl.), 24.
- GOLD, K. (1971b). Growth characteristics of the mass-reared tintinnid *Tintinnopsis beroidea*. *Mar. Biol.*, **8**, 105-108.
- GOLD, K. (1971c). Growth rate of *Tintinnopsis* sp. *J. Protozool.*, **18** (Suppl.), 27.
- GOLD, K. (1973). Methods for growing Tintinnida in continuous culture. *Am. Zool.*, **13**, 203-208.
- GOLD, K. and BAREN, C. F. (1966). Growth requirements of *Gyrodinium colvii*. *J. Protozool.*, **13**, 255-257.
- GOLD, K., PFISTER, R. N. and LIGUORI, V. R. (1970). Axenic cultivation and electron microscopy of two species of Choanoflagellida. *J. Protozool.*, **17**, 210-212.
- GOLOVINSKAYA, K. A. (1969). Artificial gynogenesis in carp. In B. I. Cherfas (Ed.), *Genetics, Selection, and Hybridization of Fish*. Nat. Mar. Fish. Serv., Washington, D.C. pp. 74-78.
- GOMEZ, E. D., FAULKNER, D. J., NEWMAN, W. A. and IRELAND, C. (1973). Juvenile hormone mimics. Effect on cirriped crustacean metamorphosis. *Science, N.Y.*, **179**, 813-814.
- GONOR, J. J. (1973). Sex ratio and hermaphroditism in Oregon intertidal populations of the echinoid *Strongylocentrotus purpuratus*. *Mar. Biol.*, **19**, 278-280.
- GOOCH, J. L. (1975). Mechanisms of evolution and population genetics. In O. Kinne (Ed.), *Marine Ecology*, Vol. II, Physiological Mechanisms, Part 1. Wiley, London. pp. 349-409.
- GOPALAKRISHNAN, K. (1972). A note on developmental and growth studies of the euphausiid *Nematoscelis difficilis* (Crustacea) based on rearing. *Mahasagar*, **5**, 31-32.
- GOREAU, T. F. (1964). On the predation of coral by the spiny starfish *Acanthaster planci* (L.) in the southern Red Sea. *Bull. Sea Fish. Res. Stn Israel*, **35**, 23-36.
- GOSLINE, J. M. (1971). Kinetics of incorporation of ¹⁴C-proline into mesogleal protecollagen and collagen of the sea anemone *Aiptasia*. In H. M. Lenhoff, L. Muscatine and L. V. Davis (Eds), *Experimental Coelenterate Biology*. University of Hawaii Press, Honolulu. pp. 146-156.
- GOSSELCK, F. (1969). Physiologisch-ökologische Untersuchungen an *Cordylophora caspia* im Unterlauf der Warnow. *Limnologica, Berl.*, **7**, 37-45.
- GOTTLIEB, D. and SHAW, P. D. (Eds) (1967). *Antibiotics*, Vol. I, Mechanism of Action. Springer-Verlag, New York.
- GOULD, H. N. (1917). Studies on sex in the hermaphrodite molluscs *Crepidula plana*. I. History of the sexual cycle. *J. exp. Zool.*, **23**, 1-69.
- GRAEFFE, E. (1882). Übersicht der Seetierfauna des Golfes von Triest. *Arb. zool. Inst. Univ. Wien*, **4**, 313-321.
- GRANGUARD, R. (1950). Les principes vitaminiques du poisson. *Congr. Int. étud. rôle poisson aliment.*, Paris, **1950**, 83-98.
- GRAS, P. (1971). Étude microbiologique des mortalités d'huitre plates, *Ostrea edulis* L., de la rivière Belon. *Revue Trav. Inst. Pêch. marit. Nantes*, **35**, 215-225.
- GRAUPNER, H. (1933). Haltung und Aufzucht von Meeresbryozoen. In E. Abderhalden (Ed.), *Handbuch der biologischen Arbeitsmethoden*, Vol. I. Urban & Schwarzenberg, Berlin. pp. 421-430.
- GRAVE, B. H. (1937a). *Bugula flabellata* and *B. turrita*. In J. G. Needham (Ed.), *Culture Methods for Invertebrate Animals*. Comstock Publishing Co., New York. pp. 178-179.
- GRAVE, B. H. (1937b). *Nereis limbata*. In J. G. Needham (Ed.), *Culture Methods for Invertebrate Animals*. Comstock Publishing Co., New York. pp. 182-183.
- GRAVE, B. H. (1937c). *Hydroides hexagonus*. In J. G. Needham (Ed.), *Culture Methods for Invertebrate Animals*. Comstock Publishing Co., New York. pp. 185-187.

- GRAY, J. S. (1965). The behaviour of *Protodrilus symbioticus* GIARD in temperature gradients. *J. Anim. Ecol.*, **34**, 455-461.
- GRAY, J. S. (1966a). Selection of sands by *Protodrilus symbioticus* GIARD. *Veröff. Inst. Meeresforsch. Bremerh.*, **2** (Sonderbd), 105-116.
- GRAY, J. S. (1966b). The attractive factor of intertidal sands to *Protodrilus symbioticus* GIARD. *J. mar. biol. Ass. U.K.*, **46**, 627-645.
- GRAY, J. S. (1966c). The response of *Protodrilus symbioticus* GIARD Archiannelida to light. *J. Anim. Ecol.*, **35**, 55-64.
- GRAY, J. S. (1967). Substrate selection by the archiannelid *Protodrilus rubropharyngeus*. *Helgoländer wiss. Meeresunters.*, **15**, 253-269.
- GRAY, J. S. and VENTILLA, R. J. (1973). Growth rates of sediment-living marine protozoan as a toxicity indicator for heavy metals. *Ambio*, **2**, 118-121.
- GRAY, W. B. (1962). Miami Seaquarium and its exhibits. *Int. Zoo Yb.*, **4**, 1-7.
- GRAYBILL, J. R. and HORTON, H. F. (1969). Limited fertilization with cryo-preserved sperm. *J. Fish. Res. Bd Can.*, **26**, 1400-1404.
- GREENFIELD, L., GIESE, A. C., FARMANFARMAIAN, A. and BOOLOOTIAN, R. A. (1958). Cyclic biochemical changes in several echinoderms. *J. exp. Zool.*, **139**, 507-524.
- GREENWOOD, A. G., HARRISON, R. J. and WHITTING, H. W. (1974). Functional and pathological aspects of the skin of marine mammals. In R. J. Harrison (Ed.), *Functional Anatomy of Marine Mammals*, Vol. 2. Academic Press, London. pp. 73-110.
- GRELL, K. G. (1954a). Zur Sexualität der Foraminiferen. *Naturwissenschaften*, **41**, 44-45.
- GRELL, K. G. (1954b). Kerndualismus bei einer Foraminifere. *Z. Naturf.*, **9b**, 241.
- GRELL, K. G. (1954c). Der Generationswechsel der polythalamen Foraminifere *Rotaliella heterocaryotica*. *Arch. Protistenk.*, **100**, 268-286.
- GRELL, K. G. (1956). Über die Elimination somatischer Kerne bei heterokaryotischen Foraminiferen. *Z. Naturf.*, **11b**, 759-761.
- GRELL, K. G. (1957). Untersuchungen über die Fortpflanzung und Sexualität der Foraminiferen. 1. *Rotaliella roseoffensis*. *Arch. Protistenk.*, **102**, 147-164.
- GRELL, K. G. (1958a). Untersuchungen über die Fortpflanzung und Sexualität der Foraminiferen. 2. *Rubratella intermedia*. *Arch. Protistenk.*, **102**, 291-308.
- GRELL, K. G. (1958b). Untersuchungen über die Fortpflanzung und Sexualität der Foraminiferen. 3. *Glabratella sulcata*. *Arch. Protistenk.*, **102**, 449-472.
- GRELL, K. G. (1958c). Studien zum Differenzierungsproblem an Foraminiferen. *Naturwissenschaften*, **45**, 25-32.
- GRELL, K. G. (1959). Untersuchungen über die Fortpflanzung und Sexualität der Foraminiferen. 4. *Patellina corrugata*. *Arch. Protistenk.*, **104**, 211-235.
- GRELL, K. G. (1968). *Protozoologie*, 2nd ed., Springer-Verlag, Berlin.
- GREVE, W. (1972). Ökologische Untersuchungen an *Pleurobrachia pileus*. 2. Laboratoriumsuntersuchungen. *Helgoländer wiss. Meeresunters.*, **23**, 141-164.
- GRICE, G. D. (1971). The developmental stages of *Eurytemora americana* WILLIAMS, 1906, and *Eurytemora herdmani* THOMPSON & SCOTT, 1897 (Copepoda, Calanoida). *Crustaceana*, **20**, 145-158.
- GRICE, G. D. and GIBSON, V. R. (1975). Occurrence, viability and significance of resting eggs of the calanoid copepod *Labidocera aestiva*. *Mar. Biol.*, **31**, 335-337.
- GRIEG, J. A. (1902). Oversigt over det nordlige Norges Echinodermner. *Bergens Mus. Årb.*, **1902**, 1-37.
- GRIEG, J. A. (1913). Bidrag til kundskaben om Hardangerfjordens fauna. *Bergens Mus. Årb.*, **1913**, 1-147.
- GRIFFIN, E. I. (1966). Making friends with a killer whale. *National Geographic Magazine*, **129**, 418-446.
- GRIFFIN, E. I. and GOLDSBERRY, D. G. (1968). Notes on the capture, care and feeding of the killer whale *Orcinus orca* at Seattle Aquarium. *Int. Zoo Yb.*, **8**, 206-208.
- GRIFFITH, G. W., MURPHY, M. A. and ROSS, L. A. (1973). A mass culture method for *Tetraselmis* sp.—A promising food for larval crustaceans. In J. W. Avault, Jr. (Ed.), *Proceedings of the Fourth Annual Workshop—World Mariculture Society*. Louisiana State University, Baton Rouge. pp. 289-294.

- GRIMMER, W. (1925). Milch verschiedener Tierarten. *Tabul. biol., Berl.*, **2**, 536-567.
- GROOM, T. T. (1894). On the early development of the Cirripedia. *Phil. Trans. R. Soc.*, **185**, 121-208.
- GROSS, A. O. (1921). The feeding habits and chemical sense of *Nereis virens* Sars. *J. exp. Zool.*, **32**, 427-442.
- GROSS, F. (1934). Zur Biologie und Entwicklungsgeschichte von *Noctiluca miliaris*. *Arch. Protistenk.*, **83**, 178-196.
- GROSS, F. (1937). Notes on the culture of some marine plankton organisms. *J. mar. biol. Ass. U.K.*, **21**, 753-768.
- GRUBE, A. E. (1868). Über einen lebendig gebärenden Seeigel. *Sber. preuss. Akad. Wiss.*, **1868**, 178-180.
- GRUFFYDD, LL. D. and BAKER, W. F. (1969). An integrated multiple unit controlled temperature system for sea water aquaria. *Lab. Pract.*, **18**, 300-304.
- GRUFFYDD, LL. D. and BEAUMONT, A. R. (1970). Determination of the optimum concentration of eggs and spermatozoa for the production of normal larvae in *Pecten maximus* (Mollusca, Lamellibranchia). *Helgoländer wiss. Meeresunters.*, **20**, 486-497.
- GRUFFYDD, LL. D. and BEAUMONT, A. R. (1972). A method for rearing *Pecten maximus* larvae in the laboratory. *Mar. Biol.*, **15**, 350-355.
- GRUFFYDD, LL. D., RIESER, R. A. and MACHIN, D. (1975). A comparison of growth and temperature tolerance in the larvae of the lobsters *Homarus gammarus* (L.) and *Homarus americanus* H. MILNE EDWARDS (Decapoda, Nephropidae). *Crustaceana*, **28**, 23-32.
- GUBERLET, J. E. (1934a). Observations on the spawning and development of some Pacific annelids. *Proc. Pacif. Sci. Congr.*, **5**, 4213-4220.
- GUBERLET, J. E. (1934b). Life history studies on some Pacific annelids. *Anat. Rec.*, **60** (Suppl.), 58-59.
- GUBERLET, J. E. (1937). A method for rearing *Nereis agassizi* and *N. procerca*. In J. G. Needham (Ed.), *Culture Methods for Invertebrate Animals*. Comstock Publishing Co., New York. pp. 184-185.
- GÜNTHER, R. T. (1895). The oyster culture of the ancient Romans. *J. mar. biol. Ass. U.K.*, **4**, 360-364.
- GÜNzl, H. (1959). Zur Physiologie der Medusenbildung bei *Eirene viridula*. *Naturwissenschaften*, **46**, 337.
- GÜNzl, H. (1964). Untersuchungen über die Auslösung der Medusenknospung bei Hydroidpolypen. *Zool. Jb. (Anat. Ontogenie Tiere)*, **81**, 491-528.
- GÜNzl, H. (1968). Über die Reifung der Nesselkapseln bei *Dipurena reesi* VANNUCCI (Hydrozoa). *Z. Zellforsch. mikrosk. Anat.*, **89**, 509-518.
- GÜNzl, H. (1973). Über die Entstehung des Nesselschlauches der Nematocysten von *Dipurena reesi* (Hydrozoa). *Helgoländer wiss. Meeresunters.*, **25**, 85-92.
- GUÉRIN, J.-P. (1973). Le développement larvaire d'*Armanitia cirrosa* FILIPPI (Annélide Polychète). *Téthys*, **4**, 969-974.
- GUILLARD, R. R. L. and RYTHÉ, J. H. (1962). Studies of marine planktonic diatoms. I. *Cyclotella nana* HUSTEDT, and *Detonula confervacea* (CLEVE) GRAN. *Can. J. Microbiol.*, **8**, 229-239.
- GULLAND, J. A. (1965). Survival of the youngest stages of fish, and its relation to year-class strength. *Spec. Publ. int. Commn NW Atlant. Fish.*, **6**, 363-371.
- GURNEY, R. (1924). The larval development of some British prawns (Palaeomonidae). I. *Palaeomonetes varians*. *Proc. zool. Soc. Lond.*, **1924**, 297-328.
- GURNEY, R. and LEBOUR, M. V. (1940). Larvae of decapod Crustacea. IV. The genus *Sergestes*. 'Discovery' Rep., **20**, 1-68.
- GUSTAFSON, T. (1969). Fertilization and development. In M. Florkin and B. J. Scheer (Eds), *Chemical Zoology*, Vol. 3. Academic Press, New York. pp. 149-206.
- HADLEY, P. B. (1906). Regarding the rate of growth of the American lobster. *Spec. Pap. 36th Ann. Rep. Comms. Inland Fish. Rhode Island*, **24**, 154-235.
- HAGENBECK, C.-H. (1962). Notes on walrus, *Odobenus rosmarus* in captivity. *Int. Zoo Yb.*, **4**, 24-25.

- HAGMEIER, A. (1933). Die Züchtung verschiedener wirbelloser Meerestiere. In E. Abderhalden (Ed.), *Handbuch der Biologischen Arbeitsmethoden*, Abtlg. 9, Teil 5, Bd 1 (Lieferung 326). Urban & Schwarzenberg, Berlin. pp. 465-598.
- HAGMEIER, A. (1951). Die Nahrung der Meerestiere. *Handb. Seefisch. Nordeur.*, **1** (5b), 86-242.
- HAGMEIER, A. and KÄNDLER, R. (1927). Neue Untersuchungen im nordfriesischen Wattenmeer und auf den fiskalischen Austerbänken. *Helgoländer wiss. Meeresunters.*, **16**, 1-90.
- HAIN, J. H. W. (1975). The behaviour of migratory eels, *Anguilla rostrata*, in response to current, salinity and lunar period. *Helgoländer wiss. Meeresunters.*, **27**, 211-233.
- HALBACH, U. (1970). Einfluß der Temperatur auf die Populationsdynamik des planktischen Rädertieres *Brachionus calyciflorus* PALLAS. *Oecologia*, **4**, 176-207.
- HALBACH, U. and HALBACH-KEUP, G. (1972). Einfluß von Außenfaktoren auf den Fortpflanzungsmodus heterogener Rotatorien. *Oecologia*, **9**, 203-214.
- HALE, L. J. (1960). Contractility and hydroplasmic movements in the hydroid *Clytia johnstoni*. *Q. Jl microsc. Sci.*, **101**, 339-350.
- HALE, L. J. (1964). A fast-flow closed-circuit marine aquarium. *Res. Rep. U.S. Fish. Wildl. Serv.*, **63**, 69-75.
- HALE, L. J. (1973). The pattern of growth of *Clytia johnstoni*. *J. Embryol. exp. Morph.*, **29**, 283-309.
- HALL, D. N. F. (1962). Observations on the taxonomy and biology of some Indo-West-Pacific Penaeidae (Crustacea, Decapoda). *Fish. Publ., Lond.*, **17**, 1-229.
- HALL, R. P. (1967). Nutrition and growth of protozoa. In T. Chen (Ed.), *Research in Protozoology*, Vol. I. Pergamon Press, Oxford. pp. 338-404.
- HALSBAND, E. (1968). Physiologische Untersuchungsmethoden zur Bestimmung des Schädlichkeitsgrades von Abwassergiften in Süß-, Brack- und Salzwasser. *Helgoländer wiss. Meeresunters.*, **17**, 224-246.
- HALVER, J. E. (1957). Nutrition of salmonoid fishes. III. Water soluble vitamin requirements of chinook salmon. *J. Nutr.*, **62**, 225-243.
- HALVER, J. E. (1966). Vitamin and amino acid requirements of Pacific salmon *Oncorhynchus*. *FAO/EIFAC 66/SC.II.3*, 61-68.
- HALVER, J. E. (1970). Nutrition in marine aquaculture. In W. J. McNeil (Ed.), *Marine Aquaculture*. Oregon State University Press, Corvallis, Oregon. pp. 75-102.
- HALVER, J. E. (Ed.) (1972a). *Fish Nutrition*, Academic Press, New York.
- HALVER, J. E. (1972b). The vitamins. In J. E. Halver (Ed.), *Fish Nutrition*. Academic Press, New York. pp. 29-103.
- HALVER, J. E. (1976). Formulating practical diets for fish. *J. Fish. Res. Bd Can.*, **33**, 1032-1039.
- HAMANN, O. (1885). Die Asteriden, anatomisch und histologisch untersucht. *Beiträge zur Histologie der Echinodermen*, **2**, 1-126.
- HAMDORF, K. (1961). Die Beeinflussung der Embryonal- und Larvalentwicklung der Regenbogenforelle (*Salmo irideus* GIBB.) durch die Umweltfaktoren O₂-Partialdruck und Temperatur. *Z. vergl. Physiol.*, **44**, 523-549.
- HAMILTON, J. E. (1933). The Southern sea lion. *Nat. Hist. Mag.*, **4**(26), 56-66.
- HAMILTON, J. E. (1934). The Southern sea lion, *Otaria byronia* (DE BLAINVILLE). 'Discovery' *Rep.*, **8**, 269-318.
- HAMILTON, J. E. (1939a). The leopard seal (*Hydrurga leptonyx*). 'Discovery' *Rep.*, **18**, 239-264.
- HAMILTON, J. E. (1939b). A second report on the Southern sea lion (*Otaria byronia*). 'Discovery' *Rep.*, **19**, 121-164.
- HAMILTON, R. D. and PRESLAN, J. E. (1969). Cultural characteristics of a pelagic marine hymenostome ciliate, *Uromma* sp. *J. exp. Biol. Ecol.*, **4**, 90-99.
- HAMMETT, F. S. (1943). The role of the amino-acids and nucleic acid components in developmental growth. I. The growth of an *Obelia* hydranth. Chapter 1: Description of *Obelia* and its growth. *Growth*, **7**, 331-400.
- HAMMETT, F. S. (1946). Correlations between the hydranth components of *Obelia* colony populations. *Growth*, **10**, 89-172.

- HAMMETT, F. S. (1950). Quantitative growth in *Obelia* colonies in culture. I. Rates of basic activities. American Document Institute, Washington, D.C. Summary in: *Growth*, **14**, 263-264.
- HAMOND, R. (1974). The culture, experimental taxonomy, and comparative morphology of the planktonic stages of Norfolk autolytoids (Polychaeta: Syllidae: Autolytinae). *Zool. J. Linn. Soc.*, **54**, 299-320.
- HANAOKA, H. (1973). Cultivation of three species of pelagic micro-crustacean plankton. *Bull. Plankton Soc. Japan*, **20**, 19-29.
- HANCOCK, D. A. (1955). The feeding behaviour of starfish on Essex oyster beds. *J. mar. biol. Ass. U.K.*, **34**, 313-331.
- HANCOCK, D. A. (1957). The feeding behavior of the sea urchin *Psammechinus miliaris* (GMELIN) in the laboratory. *Proc. zool. Soc. Lond.*, **129**, 255-262.
- HANCOCK, D. A. (1958). Notes on starfish on an Essex oyster bed. *J. mar. biol. Ass. U.K.*, **37**, 565-589.
- HANCOCK, D. A., DRINNAN, R. E. and HARRIS, W. N. (1956). Notes on the biology of *Sertularia argenta* L. *J. mar. biol. Ass. U.K.*, **35**, 307-325.
- HAND, C. and JONES, M. L. (1957). An example of reversal of polarity during asexual reproduction of a hydroid. *Biol. Bull. mar. biol. Lab., Woods Hole*, **112**, 349-357.
- HANNA, B. A. and LILLY, D. M. (1970). Axenic culture of *Uronema marinum*. *Am. Zool.*, **10**, 539-540.
- HANNA, B. A. and LILLY, D. M. (1971). Nutrition of axenic *Uronema marinum*. *Am. Zool.*, **11**, 659.
- HANNA, B. A. and LILLY, D. M. (1972). Nutritional varieties of *Uronema marinum*. *J. Protozool.*, **19** (Suppl.), 37.
- HANNA, B. A. and LILLY, D. M. (1974). Growth of *Uronema marinum* in chemically defined medium. *Mar. Biol.*, **26**, 153-160.
- HAQ, S. M. (1967). Nutritional physiology of *Metridia lucens* and *M. longa* from the Gulf of Maine. *Limnol. Oceanogr.*, **12**, 40-51.
- HAQ, S. M. (1972). Breeding of *Euterpina acutifrons*, a harpacticoid copepod, with special reference to dimorphic males. *Mar. Biol.*, **15**, 221-235.
- HARDING, G. C. H. (1974). The food of deep-sea copepods. *J. mar. biol. Ass. U.K.*, **54**, 141-155.
- HARDY, A. C. (1924). The herring in relation to its animate environment. I. The food and feeding habits of the herring with special reference to the east coast of England. *Fishery Invest. Lond.* (Ser. II), **7**, 1-53.
- HARGITT, W. and HARGITT, G. T. (1910). Studies in the development of Scyphomedusae. *J. Morph.*, **21**, 217-262.
- HARLEY, M. B. (1950). Occurrence of a filter-feeding mechanism in the polychaete *Nereis diversicolor*. *Nature, Lond.*, **165**, 734-735.
- HARLEY, M. B. (1953). The feeding habits of *Nereis diversicolor* (O. F. MÜLLER). *Br. J. Anim. Behav.*, **1**, 88.
- HARLEY, M. B. (1956). The feeding habits of *Nereis diversicolor* and related polychaetes. Ph.D. Thesis, University of London.
- HARRIS, L. G. and DOUGHERTY, E. C. (1964). Continued cultivation of the antarctic bdelloid rotifer *Philodina gregaria*. *Am. Zool.*, **4**, 259.
- HARRISON, R. J. (1960). Reproduction and reproductive organs in common seals (*Phoca vitulina*) in the Wash, East Anglia. *Mammalia*, **24**, 372-385.
- HARRISON, R. J. (1963). A comparison of factors involved in delayed implantation in badger seals in Great Britain. In A. C. Enders (Ed.), *Delayed Implantation*. University of Chicago Press, Chicago. pp. 99-114.
- HARRISON, R. J. (1968). Reproduction and reproductive organs. In H. T. Andersen (Ed.), *The Biology of Marine Mammals*. Academic Press, New York. pp. 253-348.
- HARRISON, R. J., HUBBARD, R. C., PETERSON, R. S., RICE, C. E. and SCHUSTERMAN, R. J. (Eds) (1968). *The Behavior and Physiology of Pinnipeds*, Appleton-Century-Crofts, New York.
- HARRISON, R. J. and KOOYMAN, G. L. (1968). General physiology of the Pinnipedia. In R. J.

- Harrison, R. C. Hubbard, R. S. Peterson, C. E. Rice and R. J. Schusterman (Eds), *The Behavior and Physiology of Pinnipeds*. Appleton-Century-Crofts, New York. pp. 211-296.
- HARRISON, R. J., MATTHEWS, L. H. and ROBERTS, J. M. (1952). Reproduction in some Pinnipedia. *Trans. zool. Soc., Lond.*, **27**, 437-540.
- HARRISON, R. J. and RIDGWAY, S. H. (1975). Restrained and unrestrained diving in seals. *Rapp. P.-v. Réun. Cons. int. Explor. Mer*, **169**, 76-80.
- HARRISON, R. J. and THURLEY, K. W. (1974). Structure of the epidermis in *Tursiops*, *Delphinus*, *Orcinus* and *Phocoena*. In R. J. Harrison (Ed.), *Functional Anatomy of Marine Mammals*, Vol. 2. Academic Press, London. pp. 45-71.
- HARRISON, R. J. and TOMLINSON, J. D. W. (1963). Anatomical and physiological adaptations in diving mammals. In J. D. Carthy and C. L. Duddington (Eds), *Viewpoints in Biology*, Vol. 2. Butterworth, London. pp. 115-162.
- HART, J. F. L. (1935a). The larval development of British Columbia Brachyura. I: Xanthidae, Pinnotheridae and Graspidae. *Can. J. Res.*, **12**, 411-432.
- HART, J. F. L. (1935b). Culture methods for Brachyura and Anomura. *Collecting Net*, **10**, 199-200.
- HART, J. F. L. (1937). Larval and adult stages of British Columbia Anomura. *Can. J. Res.*, **15**, 179-200.
- HART, J. S. and FISHER, H. D. (1964). The question of adaptations to polar environments in marine mammals. *Fedn Proc. Fedn Am. Socs exp. Biol.*, **23**, 1207-1214.
- HART, J. S. and IRVING, L. (1959). The energetics of Harbor seals in air and in water with special consideration of seasonal changes. *Can. J. Zool.*, **37**, 447-457.
- HARTLAUB, C. (1884). *Beobachtungen über die Entstehung der Sexualzellen bei Obelia*, Wilhelm Engelmann, Leipzig.
- HARTLAUB, C. (1895). Die Polypen und Quallen von *Stauridium productum* WRIGHT und *Perigonimus repens* WRIGHT. *Z. wiss. Zool.*, **61**, 142-162.
- HARTLAUB, C. (1896). *Über Reproduktion des Manubriums bei Sarsien und dabei auftretende siphonophorenähnliche Polygastrie*, Wilhelm Engelmann, Leipzig.
- HARTLAUB, C. (1897). Die Hydromedusen Helgolands. Zweiter Bericht. *Wiss. Meeresunters. (Helgoland)*, **2**, 449-536.
- HARTLAUB, C. (1916). Über das Altern einer Kolonie von *Syncoryne* und damit verbundene Knospungen am Hydranthenköpfchen. *Wiss. Meeresunters. (Helgoland)*, **11**, 91-125.
- HARTMAN, H. B. and CHAET, A. B. (1962). Gamete shedding with radial nerve extracts. *Fedn Proc. Fedn Am. Socs exp. Biol.*, **21**, 363.
- HARTMAN, M., EPIFANIO, C. E., PRUDER, G. and SRNA, R. (1973). Farming the artificial sea: growth of clams in a recirculating seawater system. *Proc. Gulf Caribb. Fish. Inst.*, **26**, 59-74.
- HARTMANN, M. and HUTH, W. (1936). Untersuchungen über Geschlechtsbestimmung und Geschlechtsumwandlung von *Ophryotrocha puerilis*. *Zool. Jb. (Allg. Zool. Physiol. Tiere)*, **56**, 389-439.
- HARTMANN, M. and LEWINSKY, G. VON (1938). Untersuchungen über Geschlechtsbestimmung und Geschlechtsumwandlung bei *Ophryotrocha puerilis*. II. Versuche über die Wirkung von Kalium, Magnesium und Kupfer. *Zool. Jb. (Allg. Zool. Physiol. Tiere)*, **58**, 551-574.
- HARTMANN, M. and LEWINSKY, G. VON (1942). Untersuchungen über die Geschlechtsbestimmung von *Ophryotrocha puerilis*. III. Die stoffliche Natur der vermännlichenden Wirkung 'starker' Weibchen (Eistoffe). *Zool. Jb. (Allg. Zool. Physiol. Tiere)*, **60**, 1-12.
- HARVEY, E. B. (1956). *The American Arbacia and other Sea Urchins*, Princeton University Press, Princeton, N.J.
- HARVEY, H. W. (1937). Note on selective feeding by *Calanus*. *J. mar. biol. Ass. U.K.*, **22**, 97-100.
- HASHIMOTO, Y. (1972). Nutritional requirements of warm water fish. *Riv. it. Piscic. Ittiop.*, **A.9**, 37-44.
- HASHIMOTO, Y., ARAI, S. and NOSE, T. (1970). Thiamine deficiency symptoms experimentally induced in the eel. *Bull. Jap. Soc. scient. Fish.*, **36**, 791-797.
- HASHIMOTO, Y., ARAI, S. and NOSE, T. (1972). Amino acids essential for the growth of eels, *Anguilla anguilla* and *Anguilla japonica*. *Bull. Jap. Soc. scient. Fish.*, **38**, 753-759.
- HASPER, M. (1912). On a method of rearing larvae of Bryozoa. *J. mar. biol. Ass. U.K.*, **9**, 435-436.

- HASTINGS, W. H. and DICKIE, L. M. (1972). Feed formulation and evaluation. In J. E. Halver (Ed.), *Fish Nutrition*. Academic Press, New York. pp. 327-374.
- HATANAKA, M. and KOSAKA, M. (1959). Biological studies on the population of the starfish, *Asterias amurensis*, in Sendai Bay. *Tohoku J. agric. Res.*, **4**, 159-178.
- HAUENSCHILD, C. (1953). Die phänotypische Geschlechtsbestimmung bei *Grubea clavata* CLAP. (Annel. Polych.) und vergleichende Beobachtungen an anderen Sylliden. *Zool. Jb. (Allg. Zool. Physiol. Tiere)*, **64**, 14-54.
- HAUENSCHILD, C. (1954). Genetische und entwicklungsphysiologische Untersuchungen über Intersexualität und Gewebeverträglichkeit bei *Hydractinia echinata*. *Wilhelm Roux Arch. EntwMech. Org.*, **147**, 1-41.
- HAUENSCHILD, C. (1955). Photoperiodizität als Ursache des von der Mondphase abhängigen Metamorphose-Rhythmus bei dem Polychaeten *Platynereis dumerilii*. *Z. Naturf.*, **10b**, 658-662.
- HAUENSCHILD, C. (1956a). Über die Vererbung einer Gewebeverträglichkeits-Eigenschaft bei dem Hydroidpolypen *Hydractinia echinata*. *Z. Naturf.*, **11b**, 132-138.
- HAUENSCHILD, C. (1956b). Neue experimentelle Untersuchungen zum Problem der Lunarperiodizität. *Naturwissenschaften*, **43**, 361-363.
- HAUENSCHILD, C. (1959a). Zyklische Veränderungen an den inkretorischen Drüsenzellen im Prostomium des Polychaeten *Platynereis dumerilii* als Grundlage der Schwärmpriorizität. *Z. Naturf.*, **14b**, 81-87.
- HAUENSCHILD, C. (1959b). Weitere Kreuzungsversuche zur Frage der Geschlechtsbestimmung bei dem Polychaeten *Grubea clavata*. *Z. Naturf.*, **14b**, 89-92.
- HAUENSCHILD, C. (1959c). Hemmender Einfluß der Proventrikelregion auf Stolonisation und Oocyten-Entwicklung bei dem Polychaeten *Autolytus prolifer*. *Z. Naturf.*, **14b**, 87-89.
- HAUENSCHILD, C. (1960). Abhängigkeit der Regenerationsleistung von der inneren Sekretion im Prostomium bei *Platynereis dumerilii*. *Z. Naturf.*, **15b**, 52-55.
- HAUENSCHILD, C. (1961). Die Schwärmpriorizität von *Platynereis dumerilii* im DD/LD-Belichtungszyklus und nach Augenausaltung. *Z. Naturf.*, **16b**, 753-756.
- HAUENSCHILD, C. (1962). Die Zucht mariner Wirbelloser im Laboratorium (Methode und Anwendung). *Kieler Meeresforsch.*, **18** (Sonderheft), 28-37.
- HAUENSCHILD, C. (1968). Hälterung und Laboratoriumszuchten von Invertebraten. In C. Schlieper (Ed.), *Methoden der meeresbiologischen Forschung*. VEB G. Fischer, Jena. pp. 192-209.
- HAUENSCHILD, C. (1970). Die Zucht von niederen marinen Wirbellosen und ihre Anwendung in der experimentellen Zoologie. *Helgoländer wiss. Meeresunters.*, **20**, 249-263.
- HAUENSCHILD, C. (1974). Normalisierung der geschlechtlichen Entwicklung kopfloser Fragmente junger ♀♀ von *Platynereis dumerilii* (Polychaeta) durch Behandlung mit konservierten Prostomien juveniler Individuen. *Helgoländer wiss. Meeresunters.*, **26**, 63-81.
- HAUENSCHILD, C., FISCHER, A. and HOFMANN, D. K. (1968). Untersuchungen am pazifischen Palolowurm *Eunice viridis* (Polychaeta) in Samoa. *Helgoländer wiss. Meeresunters.*, **18**, 254-295.
- HAUENSCHILD, C. and KANELIS, A. (1953). Experimentelle Untersuchungen an Kulturen von *Hydractinia echinata* FLEMM. zur Frage der Sexualität und Stockdifferenzierung. *Zool. Jb. (Allg. Zool. Physiol. Tiere)*, **64**, 1-13.
- HAVINGA, B. (1933). Der Seehund (*Phoca vitulina* L.) in den Holländischen Gewässern. *Tijdschr. ned. dierk. Vereen.*, **3**, 79-111.
- HAZLETT, B. A. (1971). Influence of rearing conditions on initial shell entering behavior of a hermit crab (Decapoda, Paguridea). *Crustaceana*, **20**, 167-170.
- HAZLETT, B. A. and PROVENZANO, A. J., JR. (1965). Development of behavior in laboratory reared hermit crabs. *Bull. mar. Sci.*, **15**, 616-633.
- HEDLEY, R. H. and WAKEFIELD, J. ST. (1967). Clone culture studies of a new Rosalinid foraminifer from Plymouth, England and Wellington, New Zealand. *J. mar. biol. Ass. U.K.*, **47**, 121-128.
- HEEGAARD, P. (1953). Observations on spawning and larval history of the shrimp, *Penaeus setiferus* (L.). *Pub. Inst. Mar. Sci.*, **3**, 75-105.
- HEINEN, A. (1911). Die Nephthydeen und Lycorideen der Nord- und Ostsee, einschließlich der verbindenden Meeresteile. *Wiss. Meeresunters. Abt. Kiel*, **13**, 1-87.

- HEINLE, D. R. (1969a). The effects of temperature on the population dynamics of estuarine copepods. Ph.D. Thesis, University of Maryland.
- HEINLE, D. R. (1969b). Culture of calanoid copepods in synthetic sea water. *J. Fish. Res. Bd Can.*, **26**, 150-153.
- HEINLE, D. R. (1970). Population dynamics of exploited cultures of calanoid copepods. *Helgoländer wiss. Meeresunters.*, **20**, 360-372.
- HEINLE, D. R. and FLEMER, D. A. (1975). Carbon requirements of a population of the estuarine copepod *Eurytemora affinis*. *Mar. Biol.*, **31**, 235-247.
- HELM, M. M., HOLLAND, D. L. and STEPHENSON, R. R. (1973). The effect of supplementary algal feeding of a hatchery breeding stock of *Ostrea edulis* L. on larval vigour. *J. mar. biol. Ass. U.K.*, **53**, 673-684.
- HELM, M. M. and SPENCER, B. E. (1972). The importance of the rate of aeration in hatchery cultures of the larvae of *Ostrea edulis* L. *J. Cons. perm. int. Explor. Mer*, **34**, 244-255.
- HEMMINGS, C. C. (1966). Olfaction and vision in fish schooling. *J. exp. Biol.*, **45**, 449-464.
- HEMPEL, C. (1957). Über den Röhrenbau und die Nahrungsaufnahme einiger Spioniden (*Polychaeta sedentaria*) der deutschen Küsten. *Helgoländer wiss. Meeresunters.*, **6**, 100-135.
- HEMPELMANN, F. (1931). Archiannelida und Polychaeta. In W. Kükenthal and T. Krumbach (Eds), *Handbuch der Zoologie*, 2 (2). De Gruyter, Berlin. pp. 1 (7)-212 (7).
- HENTIG, R. VON (1971). Einfluss von Salzgehalt und Temperatur auf Entwicklung, Wachstum, Fortpflanzung und Energiebilanz von *Artemia salina*. *Mar. Biol.*, **9**, 145-182.
- HENTSCHEL, E. (1916). Biologische Untersuchungen über den tierischen und pflanzlichen Bewuchs im Hamburger Hafen. *Mitt. Zool. Mus. Hamburg*, **33**, 1-176.
- HENTSCHEL, H. (1950). Die Nahrung der Heringslarven. *Helgoländer wiss. Meeresunters.*, **3**, 59-81.
- HERBST, C. (1892). Experimentelle Untersuchungen über den Einfluß der veränderten chemischen Zusammensetzung des umgebenden Mediums auf die Entwicklung der Thiere. I. Theil. Versuche an Seeigeleiern. *Z. wiss. Zool.*, **55**, 446-518.
- HERBST, C. (1897). Über die zur Entwicklung der Seeigellarven nothwendigen anorganischen Stoffe, ihre Rolle und ihre Vetretbarkeit. I. Theil. Die zur Entwicklung nothwendigen anorganischen Stoffe. *Arch. EntwMech. Org.*, **5**, 649-793.
- HERBST, C. (1904). Über die zur Entwicklung der Seeigellarven nothwendigen anorganischen Stoffe, ihre Rolle und ihre Vetretbarkeit. III. Theil. Die Rolle der nothwendigen anorganischen Stoffe. *Arch. EntwMech. Org.*, **17**, 306-520.
- HERDMAN, W. A. (1894). Note on a lobster hatchery. *Proc. Trans. Lpool biol. Soc.*, **8**, 93-96.
- HERDMAN, W. A. (1906). Report to the Government of Ceylon on the pearl oyster fisheries of the Gulf of Manaar. *Royal Soc. Lond.*, **5**.
- HERPIN, R. (1925). Recherches biologiques sur la reproduction et le développement de quelques annélides polychètes. *Bull. Soc. Sci. nat. Quest Fr.* (Ser. 4), **5**, 1-250.
- HERRICK, F. H. (1888). The development of *Alpheus*. *Johns Hopkins Univ. Circ.*, **7**, 36-37.
- HERRICK, F. H. (1909). Natural history of the American lobster. *Bull. Bur. Fish., Wash.*, **29**, 149-408.
- HERRING, P. J. (1967). Observations on the early larvae of three species of *Acanthephyra* (Crustacea, Decapoda, Caridea). *Deep Sea Res.*, **14**, 325-329.
- HERRING, P. J. (1972). Observations on the distribution and feeding habits of some littoral echinoids from Zanzibar. *J. nat. Hist.*, **6**, 169-175.
- HERRING, P. J. (1974). Observations on the embryonic development of some deep-living decapod crustaceans, with particular reference to species of *Acanthephyra*. *Mar. Biol.*, **25**, 25-33.
- HERRMANN, K. (1975). Einfluß von Bakterien auf die Metamorphose-Auslösung und deren Verlauf bei *Actinotrocha brachiata* (*Phoronis muelleri*). *Verh. dt. zool. Ges.*, **67**, 112-115.
- HERTEL, E. W. (1942). Studies on vigor in the rotifer *Hydatina senta*. *Physiol. Zool.*, **15**, 304-324.
- HERTLING, H. (1932). Die Züchtung von Meeresfischen für wissenschaftliche und praktische Zwecke. In E. Abderhalden (Ed.), *Handbuch der Biologischen Arbeitsmethoden*, Abt, 9, Teil 6, Heft 2. Urban & Schwarzenberg, Berlin. pp. 195-366.
- HERTWIG, O. (1876). Beiträge zur Kenntnis der Bildung, Befruchtung und Theilung des thierischen Eies. I. *Gegenbaurs morph. Jb.*, **1**, 347-434.

- HERTWIG, O. (1877). Beiträge zur Kenntnis der Bildung, Befruchtung und Theilung des thierischen Eies. II. *Gegenbaurs morph. Jb.*, **2**, 1-86.
- HERTWIG, O. (1878). Beiträge zur Kenntnis der Bildung, Befruchtung und Theilung des thierischen Eies. III. *Gegenbaurs morph. Jb.*, **4**, 156-213.
- HERTWIG, O. and HERTWIG, R. (1887). Über den Befruchtungs- und Theilungsvorgang des thierischen Eies unter dem Einfluß äußerer Agentien. Untersuchungen zur Morphologie und Physiologie der Zelle. *Jena. Z. Naturw.*, **20**, 120.
- HERZ, L. E. (1933). The morphology of the later stages of *Balanus crenatus* BRUGUIÈRE. *Biol. Bull. mar. biol. Lab., Woods Hole*, **64**, 432-442.
- HESS, W. N. (1937). Earthworms. In J. G. Needham (Ed.), *Culture Methods for Invertebrate Animals*. Comstock Publishing Co., New York. pp. 195-196.
- HEUTS, M. J. (1947). Experimental studies on adaptative evolution in *Gasterosteus aculeatus* L. *Evolution, Lancaster, Pa.*, **1**, 89-102.
- HEWATT, W. G. (1937). Ecological studies on selected marine intertidal communities of Monterey Bay, California. *Am. Midl. Nat.*, **18**, 161-206.
- HEWER, H. R. (1957). A Hebridean breeding colony of grey seals, *Halichoerus grypus* (FAB.), with comparative notes on the grey seals of Ramsey Island, Pembrokeshire. *Proc. zool. Soc. Lond.*, **128**, 23-66.
- HEWER, H. R. (1960). Behaviour of the grey seal (*Halichoerus grypus* FAB.) in the breeding season. *Mammalia*, **24**, 400-421.
- HEWER, H. R. (1964). The determination of age, sexual maturity, longevity and life-table in the grey seal (*Halichoerus grypus*). *Proc. zool. Soc. Lond.*, **142**, 593-624.
- HEWLETT, K. G. and NEWMAN, M. A. (1968). 'Skana', the killer whale *Orcinus orca* at Vancouver Public Aquarium. *Int. Zoo Yb.*, **8**, 209-211.
- HEYDORN, A. E. F. (1974). Summary of reading on the Durban Aquarium, South Africa, and its plans for a marine mammal display. *Aquatic Mammals*, **2**, 29-31.
- HIATT, R. W. (1944). Food chains and food cycles in Hawaiian fish ponds. Part I. The food and feeding habits of mullet (*Mugil cephalus*), milkfish (*Chanos chanos*), and the ten-pounder (*Elops machnata*). *Trans. Am. Fish. Soc.*, **74**, 250-261.
- HIATT, R. W. (1948). The biology of the lined shore crab, *Pachygrapsus crassipes* RANDALL. *Pacif. Sci.*, **2**, 135-213.
- HICKLING, C. F. (1963). The cultivation of *Tilapia*. *Scient. Am.*, **208**, 143-152.
- HICKLING, C. F. (1967). Fish hybridization. *F.A.O. Fish. Rep.*, **44**, 1-11.
- HIDU, H. (1969). Gregarious setting in the American oyster *Crassostrea virginica* GMELIN. *Chesapeake Sci.*, **10**, 85-92.
- HIDU, H. and ÜKELES, R. (1962). Dried unicellular algae as food for larvae of the hard shell clam, *Mercenaria mercenaria*. *Proc. natn. Shellfish. Ass.*, **53**, 85-101.
- HIDU, H., VEITCH, F. P. and O'BRIEN, P. E. (1969). Gregarious setting in the American oyster. *Proc. natn. Shellfish. Ass.*, **60**, 4.
- HILL, B. J. (1974). Salinity and temperature tolerance of zoeae of the portunid crab *Scylla serrata*. *Mar. Biol.*, **25**, 21-24.
- HILL, B. J. (1975). Abundance, breeding and growth of the crab *Scylla serrata* in two South African estuaries. *Mar. Biol.*, **32**, 119-126.
- HINCHCLIFFE, P. H. and RILEY, J. P. (1972). The effect of diet on the component fatty-acid composition of *Artemia salina*. *J. mar. biol. Ass. U.K.*, **52**, 203-211.
- HINDLEY, J. P. R. (1975). Effects of endogenous and some exogenous factors on the activity of the juvenile banana prawn *Penaeus merguensis*. *Mar. Biol.*, **29**, 1-8.
- HINEGARDNER, R. T. (1969). Growth and development of the laboratory cultured sea urchin. *Biol. Bull. mar. biol. Lab., Woods Hole*, **137**, 465-475.
- HINEGARDNER, R. T. (1975). Care and handling of sea urchin eggs, embryos, and adults (principally North American species). In G. Czihak (Ed.), *The Sea Urchin Embryo. Biochemistry and Morphogenesis*. Springer-Verlag, Berlin. pp. 10-25.
- HIRANO, R. (1952). On the rearings and metamorphoses of four important barnacles in Japan. (Jap.; Engl. abstract.) *J. Ocean. Soc. Japan*, **8**, 139-143.
- HIRANO, R. (1969). Rearing of black sea bream larva. (Jap.) *Bull. Jap. Soc. scient. Fish.*, **35**, 567-569, 603-604.

- HIRATA, H. (1974). An attempt to apply an experimental microcosm for the mass culture of marine rotifer, *Brachionus plicatilis* MULLER. *Mem. Fac. Fish. Kagoshima Univ.*, **23**, 163-172.
- HIRATA, H. and MORI, Y. (1967). Mass-culture of marine rotifer, *Brachionus plicatilis*, fed the bread yeast. *Saibai-Gyogyo*, **5**, 36-40.
- HIRATA, H., MORI, Y. and WATANABE, M. (1975). Rearing of prawn larvae, *Penaeus japonicus*, fed soy-cake particles and diatoms. *Mar. Biol.*, **29**, 9-13.
- HIRAYAMA, K. and KUSANO, T. (1972). Fundamental studies on physiology of rotifer for its mass culture. II. Influence of water temperature on population growth of rotifer. *Bull. Jap. Soc. scient. Fish.*, **38**, 1357-1363.
- HIRAYAMA, K. and OGAWA, S. (1972). Fundamental studies on physiology of rotifer for its mass culture. I. Filter feeding of rotifer. *Bull. Jap. Soc. scient. Fish.*, **38**, 1207-1214.
- HIRAYAMA, K. and WATANABE, K. (1973). Fundamental studies on physiology of rotifer for its mass culture. IV. Nutritional effect of yeast on population growth of rotifer. *Bull. Jap. Soc. scient. Fish.*, **39**, 1129-1133.
- HIRAYAMA, K., WATANABE, K. and KUSANO, T. (1973). Fundamental studies on physiology of rotifer for its mass culture. III. Influence of phytoplankton density on population growth. *Bull. Jap. Soc. scient. Fish.*, **39**, 1123-1127.
- HIROSE, K. and ISHIDA, R. (1974). Induction of ovulation in the ayu, *Plecoglossus altivelis*, with LH-releasing hormone. *Bull. Jap. Soc. scient. Fish.*, **40**, 1235-1240.
- HJORT, J. (1914). Fluctuations in the great fisheries of northern Europe viewed in the light of biological research. *Rapp. P.-v. Réun. Cons. perm. int. Explor. Mer*, **20**, 1-228.
- HJORT, J. (1926). Fluctuations in the year-classes of important food fishes. *J. Cons. perm. int. Explor. Mer*, **1**, 5-38.
- HODGINS, H. O. and RIDGWAY, G. J. (1964). Recovery of viable salmon spermatozoa after fast freezing. *Progre Fish Cult.*, **26**, 95.
- HÖRSTADIUS, S. (1973). *Experimental Embryology of Echinoderms*, Clarendon Press, Oxford.
- HOEY, A. and THORNTON, K. R. (1971). Techniques of management of killer whales in capture in a cold water environment. In *Proceedings of 8th Annual Conference on Biological Sonar and Diving Mammals*. Stanford Research Institute, Menlo Park, California, pp. 13-22.
- HOFMANN, D. K. (1966). Untersuchungen zur Regeneration des Hinterendes bei *Platynereis dumerilii* (AUDOUIN et MILNE-EDWARDS) (Annelida, Polychaeta). *Zool. Jb. (Allg. Zool. Physiol. Tiere)*, **72**, 374-430.
- HOLDEN, A. V. (1975). The accumulation of oceanic contaminants in marine mammals. *Rapp. P.-v. Réun. Cons. int. Explor. Mer*, **169**, 353-361.
- HOLLAND, D. L. and WALKER, G. (1975). The biochemical composition of the cypris larva of the barnacle *Balanus balanoides* L. *J. Cons. int. Explor. Mer*, **36**, 162-165.
- HOLLAND, N. D. (1967). Gametogenesis during the annual reproductive cycle in a cidaroid sea urchin (*Stylocidaris affinis*). *Biol. Bull. mar. biol. Lab., Woods Hole*, **133**, 578-590.
- HOLLING, C. S. (1965). The functional response of predators to prey density and its role in mimicry and population regulation. *Mem. Entomol. Soc. Can.*, **45**, 5-60.
- HOLST-SØRENSEN, H. and RASMUSSEN, L. (1971). Growth promoting effects of particulate material in cultures of *Acanthamoeba*. *C.R. Trav. Lab. Carlsberg.*, **38**, 163-169.
- HOLTHUIS, L. B. (1952a). A general revision of the Palaemonidae (Crustacea, Decapoda, Natantia) of the Americans. 2. The subfamily Palaemonidae. *Occ. Pap., Allan Hancock Found. Publ.*, **12**, 1-396.
- HOLTHUIS, L. B. (1952b). On some Indo-Westpacific Palaemonidae (Crustacea, Decapoda, Caridea). *Zoöl. Meded., Leiden*, **31**, 201-211.
- HOLZ, G. G., JR. (1964). Nutrition and metabolism of ciliates. In S. H. Hutner (Ed.), *Biochemistry and Physiology of Protozoa*. Vol. 3. Academic Press, New York. pp. 199-242.
- HOLZ, G. G., JR., ERWIN, J., ROSENBAUM, N. and AARONSON, S. (1962). Triparanol inhibition of *Tetrahymena*, and its prevention by lipids. *Archs Biochem. Biophys.*, **98**, 312-322.
- HOMESTEAD, R. (1971). A portable instantaneous branding device for permanent identification of wildlife. In *Proceedings of the 8th Annual Conference on Biological Sonar and Diving Mammals*, Stanford Research Institute, Menlo Park, California. pp. 1-5.
- HOOD, M. A. and MEYERS, S. P. (1973). Microbial aspects of penaeid shrimp digestion. *Gulf & Caribbean Fisheries Institute, 26th Ann. Session*, 81-92.

- HOPE, W. D. and MURPHY, D. G. (1972). A taxonomic hierarchy and checklist of the genera and higher taxa of marine nematodes. *Smithson. Contr. Zool.*, **137**, 1-101.
- HOPPENHEIT, M. (1975). Zur Dynamik exploitierter Populationen von *Tisbe holothuriae* (Copepoda, Harpacticoida). I. Methoden, Verlauf der Populationsentwicklung und Einfluß der Wassererneuerung. *Helgoländer wiss. Meeresunters.*, **27**, 235-253.
- HOPPER, B. E., FELL, J. W. and CEFALU, R. C. (1973). Effect of temperature on life cycles of nematodes associated with the mangrove (*Rhizophora mangle*) detrital system. *Mar. Biol.*, **23**, 293-296.
- HOPPER, B. E. and MEYERS, S. P. (1966a). Observations on the bionomics of the marine nematode, *Metoncholaimus* sp. *Nature, Lond.*, **209**, 899-900.
- HOPPER, B. E. and MEYERS, S. P. (1966b). Aspects of the life cycle of marine nematodes. *Helgoländer wiss. Meeresunters.*, **13**, 444-449.
- HOPPER, B. E., MEYERS, S. P. and CEFALU, R. C. (1970). Microsporidian infection of a marine nematode, *Metoncholaimus scissus*. *J. invertebr. Path.*, **16**, 371-377.
- HORI, J. and KUSAKABE, D. (1927). On the artificial culture of oyster larvae. (Jap.) *J. imp. Fish. Inst., Tokyo*, **23**, 79.
- HORNELL, J. (1891). Report on the polychaetous annelids of the L.M.B.C. district. *Proc. Trans. Lpool biol. Soc.*, **5**, 223-268.
- HORTON, H. F. and OTT, A. G. (1976). Cryopreservation of fish spermatozoa and ova. *J. Fish. Res. Bd Can.*, **33**, 995-1000.
- HOUDE, E. D. (1974). Effects of temperature and delayed feeding on growth and survival of larvae of three species of subtropical marine fishes. *Mar. Biol.*, **26**, 271-285.
- HOUDE, E. D. and RICHARDS, W. J. (1969). Rearing of larval tunas in the laboratory. *Comm. Fish. Rev.*, **31**, 32-34.
- HOURSTON, A. S., ROSENTHAL, H. and STACEY, N. (1975). Preliminary observations on spawning behaviour of Pacific herring in captivity. *Coun. Meet. int. Coun. Explor. Sea (C.M.-I.C.E.S.) H: 8*.
- HOWELL, B. R. (1971). Rearing the larvae of the lemon sole, *Microstomus kitt* WALBAUM, on cultured food. *Coun. Meet. int. Coun. Explor. Sea (C.M.-I.C.E.S.) E: 26*.
- HOWELL, B. R. (1973). Problems associated with the feeding of certain flatfish larvae. *Inf. Tec. Inst. Invest. Pesq., Barc.*, **14**, 109-116.
- HOYLE, R. J. and IDLER, D. R. (1968). Preliminary results in the fertilization of eggs with frozen sperm of Atlantic salmon (*Salmo salar*). *J. Fish. Res. Bd Can.*, **25**, 1295-1297.
- HUBBARD, R. C. (1968). Husbandry and laboratory care of pinnipeds. In S. H. Ridgway (Ed.), *The Behavior and Physiology of Pinnipeds*. Appleton-Century-Crofts, New York. pp. 299-358.
- HUBSCHMAN, J. H. and BROAD, A. C. (1974). The larval development of *Palaemonetes intermedius* HOLTHUIS, 1949 (Decapoda, Palaemonidae) reared in the laboratory. *Crustaceana*, **26**, 89-103.
- HUBSCHMAN, J. H. and ROSE, J. A. (1969). *Palaemonetes kadiakensis* RATHBUN: post embryonic growth in the laboratory (Decapoda, Palaemonidae). *Crustaceana*, **16**, 81-87.
- HUDINAGA, M. (1935). The study of *Penaeus*. I. The development of *Penaeus japonicus* BATE. *Rep. Hayatomo Fish. Res. Lab.*, **1**, 1-51.
- HUDINAGA, M. (1942). Reproduction, development and rearing of *Penaeus japonicus* BATE. *Jap. J. Zool.*, **10**, 305-393.
- HUDINAGA, M. and KASAHARA, H. (1941). Larval development of *Balanus amphitrite hawaiiensis*. *Zool. Mag., Tokyo*, **54**, 108-118.
- HUDINAGA, M. and KITTAKA, J. (1966). Studies on food and growth of larval stage of a prawn, *Penaeus japonicus*, with reference to the application to practical mass culture. *Inf. Bull. Planktol. Japan*, **13**, 83-94.
- HUDINAGA, M. and KITTAKA, J. (1967). The large scale production of the young Kuruma prawn, *Penaeus japonicus* BATE. *Inf. Bull. Planktol. Japan* (Commém. No. of Dr. Y. Matsue, pp. 35-46).
- HUDINAGA, M. and MIYAMURA, M. (1962). Breeding of the 'Kuruma' prawn (*Penaeus japonicus* BATE). *J. oceanogr. Soc. Jap.* (20th Anniv. Vol.), **694-706**.
- HUDSON, R. C. L. (1965). A new contractile region in the stolon of the hydroid *Clytia johnstoni*. *Biol. J.*, **5**, 14-22.

- HUET, M. (1970). *Traité de Pisciculture*, 4th ed., Editions Ch. de Wyngaert, Brussels.
- HUGHES, E. (1940). The breeding of oysters in tanks. *J. mar. biol. Ass. U.K.*, **24**, 543-547.
- HUGHES, J. T., SHLESER, R. A. and TCHOBANOGLOUS, G. (1974). A rearing tank for lobster larvae and other aquatic species. *Progve Fish. Cult.*, **36**, 129-133.
- HUGHES, J. T., SULLIVAN, J. J. and SHLESER, R. A. (1972). Enhancement of lobster growth. *Science, N.Y.*, **177**, 1110-1111.
- HUGHES, R. H. (1969). A study of feeding in *Scrobicularia plana*. *J. mar. biol. Ass. U.K.*, **49**, 805-823.
- HULINGS, N. C. and HEMLAY, D. W. (1963). An investigation of the feeding habits of two species of sea stars. *Bull. mar. Sci. Gulf Caribb.*, **13**, 354-359.
- HULL, R. W. (1956). Reproductive potential of isolated *Podophrya collini*. *J. Protozool.*, **3** (Suppl.), 11.
- HUMPHREYS, T. (1963). Chemical dissolution and *in vitro* reconstruction of sponge cell adhesions. I. Isolation and functional demonstration of the components involved. *Devl Biol.*, **8**, 27-47.
- HUNT, O. D. (1925). The food of the bottom fauna of the Plymouth fishing grounds. *J. mar. biol. Ass. U.K.*, **13**, 560-599.
- HUNTER, J. R. (1966). Procedure for analysis of schooling behavior. *J. Fish. Res. Bd Can.*, **23**, 547-562.
- HUNTER, J. R. (1968). Effect of light on schooling and feeding of Jack mackerel *Trachurus symmetricus*. *J. Fish. Res. Bd Can.*, **25**, 393-407.
- HUNTER, J. R. (1972). Swimming and feeding behavior of larval anchovy *Engraulis mordax*. *Fish. Bull. Calif.*, **70**, 821-838.
- HUNTER, J. R. (unpublished manuscript). Culture and growth of anchovy larvae *Engraulis mordax* GIRARD.
- HUNTER, J. R. and THOMAS, G. L. (1974). Effect of prey distribution and density on the searching and feeding behaviour of larvae anchovy *Engraulis mordax* GIRARD. In J. H. S. Blaxter (Ed.), *The Early Life History of Fish*. Springer-Verlag, Berlin. pp. 559-574.
- HUTH, W. (1934). *Ophryotrocha*-Studien. I. Zur Cytologie der Ophryotrochen. *Z. Zellforsch. mikroskop. Anat.*, **20**, 309-381.
- HUTNER, S. H. (1962). Nutrition of protists. In W. H. Johnson and W. C. Steere (Eds), *This is Life*. Holt, Rinehart and Winston, New York. pp. 109-138.
- HUTNER, S. H. (1964). Protozoa as toxicological tools. *J. Protozool.*, **11**, 1-6.
- HUTNER, S. H., AARONSON, S., NATHAN, H. A., BAKER, H., SCHER, S. and CURY, A. (1958). Trace elements in microorganisms: the temperature factor approach. In C. A. Lamb, O. G. Bentley and J. M. Beattie (Eds), *Trace Elements*. Academic Press, New York. pp. 47-65.
- HUTNER, S. H., PROVASOLI, L. and BAKER, H. (1961). Development of microbial assays for biochemical, oceanographic, and clinical use. *Microchem. J.* (Symp. Ser.), **1**, 95-113.
- HUTNER, S. H., PROVASOLI, L., SCHATZ, A. and HASKINS, C. P. (1950). Some approaches to the study of the role of metals in the metabolism of microorganisms. *Proc. Am. phil. Soc.*, **94**, 152-170.
- HUXLEY, J. S. (1921). Differences in viability in different types of regenerates from dissociated sponges, with a note on the entry of somatic cells by spermatozoa. *Biol. Bull. mar. biol. Lab., Woods Hole*, **40**, 127-129.
- HUXLEY, J. S. and DE BEER, G. R. (1923). Studies in dedifferentiation. IV. Resorption and differential inhibition in *Obelia* and *Campanularia*. *Q. Jl microsc. Sci.*, **67**, 473-495.
- HYLLEBERG, J. and GALLUCCI, V. F. (1975). Selectivity in feeding by the deposit-feeding bivalve *Macoma nasuta*. *Mar. Biol.*, **32**, 167-178.
- HYMAN, L. H. (1951). *The Invertebrates: Acanthocephala, Aschelminthes, and Entoprocta. The Pseudocoelomate Bilateria*, Vol. III. McGraw-Hill, New York.
- HYMAN, L. H. (1955). *The Invertebrates: Echinodermata. The Coelomate Bilateria*, Vol. IV, McGraw-Hill, New York.
- HYMAN, L. H. (1959). *The Invertebrates: Smaller Coelomate Groups. Chaetognatha, Hemichordata, Pogonophora, Phoronida, Ectoprocta, Brachipoda, Sipunculida. The Coelomate Bilateria*, Vol. V. McGraw-Hill, New York.

- HYMAN, L. H. (Ed.) (1967). *The Invertebrates: Mollusca I*, Vol. VI, McGraw-Hill, New York.
- IBRAHIM, K. H. (1969a). Techniques of collection, processing and storage of fish pituitary gland. *FAO/UNDP Regional Seminar on Induced Spawning of Cultivated Fishes, India.*
- IBRAHIM, K. H. (1969b). Preparation, preservation and ampouling of fish pituitary extract. *FAO/UNDP Regional Seminar on Induced Spawning of Cultivated Fishes, India.*
- ICHIHARA, T. (1972). Maximum sustainable yield from the Robben fur seal herd. *Bull. Far Seas Fish. Res. Lab.*, **6**, 77-94.
- IDYLL, C. P., TABB, D. C. and YANG, W. T. (1970). Aquaculture: the new shrimp crop. *Univ. Miami Sea Grant Info., Leaflet*, **1**, 1-5.
- IDA, T. (1942). A method for obtaining sea-urchin eggs without dissecting ovaries. (Jap.) *Zool. Mag., Tokyo*, **54**, 280.
- IKEDA, T. (1973). On the criteria to select copepod species for mass culture. *Bull. Plankton Soc. Japan*, **20**, 41-48.
- IKEGAMI, S. and TAMURA, S. (1973). Spawning control in starfish. *Experientia*, **29**, 325.
- IMAI, T. (1967). Mass production of molluscs by means of rearing the larvae in tanks. *Venus, Kyoto*, **25**, 159-167.
- IMAI, T., HATANAKA, M., SATO, R., SAKAI, S. and YUKI, R. (1950). Artificial breeding of oysters in tanks. *Tohoku J. agric. Res.*, **1**, 69-86.
- IMAI, T. and NISHIKAWA, N. (1969). Artificial mass production of the young of scallop and bloody clam. (Jap.) *Aquaculture, Tokyo*, **16**, 309-316.
- IMAI, T., SAKAI, S., OKADA, H. and YOSHIDA, T. (1954). Breeding of the Olympia oyster in tanks and culture experiments in Japanese waters. *Tohoku J. agric. Res.*, **5**, 13-25.
- IMLER, R. H. and SARBER, H. R. (1947). Harbor seals and sea lions in Alaska. *Spec. scient. Rep. U.S. Fish Wildl. Serv.*, **28**, 1-23.
- INASE, M. (1960a). On the double embryo of the aquatic worm, *Tubifex hattai*. *Sci. Rep. Tohoku Univ.* (Ser. 4, Biol.), **26**, 59-64.
- INASE, M. (1960b). The culture solution of the eggs of *Tubifex*. *Sci. Rep. Tohoku Univ.* (Ser. 4, Biol.), **26**, 65-67.
- INGLE, R. M. and ELDRED, B. (1960). Notes on the artificial cultivation of fresh water shrimp. *West Indies Fish. Bull.*, **1960**, 1-5.
- INO, T. (1952). Biological studies on the propagation of the Japanese abalone (genus *Haliotis*). (Jap.) *Bull. Tokai reg. Fish. Res.*, **5**, 1-102.
- INO, T., SAGARA, J., HAMADA, S. and TAMAKAWA, M. (1955). On the spawning season of the starfish *Asterias amurensis*, in Tokyo Bay. *Bull. Jap. Soc. scient. Fish.*, **21**, 32-36.
- INOUE, M. (1969). Artificial mass production of the young of abalone and their release into natural environments. (Jap.) *Aquaculture, Tokyo*, **16**, 295-304.
- INOUE, M. and AOKI, M. (1969). Reproduction of Copepoda, *Tisbe furcata*, cultured with sea-water acclimatized *Chlorella* as a basic diet. *Bull. Jap. Soc. scient. Fish.*, **35**, 862-867.
- IRVINE, A. B. (1970a). Transportation of small cetaceans. *Naval Undersea Research and Development Center, Technical Paper*. (Quoted in RIDGWAY, 1972b.)
- IRVINE, A. B. (1970b). Conditioning marine mammals to work in the sea. *Mar. Tech. Soc. J.*, **4**, 47-52.
- IRVINE, J. and COFFIN, H. G. (1960). Laboratory culture and early stages of *Fabia subquadrata* (DANA), (Crustacea, Decapoda). *Walla Walla Coll. Publs. biol. Sci.*, **28**, 1-24.
- IRVING, L. (1969). Temperature regulation in marine mammals. In H. T. Andersen (Ed.), *The Biology of Marine Mammals*. Academic Press, New York. pp. 147-174.
- IRVING, L., FISHER, K. C. and MACINTOSH, F. C. (1935). The water balance of a marine mammal, the seal. *J. cell. comp. Physiol.*, **6**, 387-391.
- IRVING, L. and HART, J. S. (1957). The metabolism and insulation of seals as bare-skinned mammals in cold water. *Can. J. Phys.*, **35**, 497-511.
- IRVING, L., PEYTON, L. J., BAHN, C. H. and PETERSON, R. S. (1962). Regulation of temperature in fur seals. *Physiol. Zool.*, **35**, 275-284.
- ISHIDA, J. (1936). An enzyme dissolving the fertilization membrane of sea urchin eggs. *Annotnes zool. jap.*, **15**, 453-457.
- ISHIDA, J. (1967). *Cell Biology*, Asakura Shoten, Tokyo.
- ISHIDA, S. and YASUGI, R. (1937). Free-swimming stages of *B. amphitrite albicostatus*. *Botany Zool., Tokyo*, **5**, 1659-1666.

- ISHIKAWA, M. (1975a). Fertilization. In G. Czihak (Ed.), *The Sea Urchin Embryo*. Springer-Verlag, Berlin, pp. 99-147.
- ISHIKAWA, M. (1975b). Parthenogenetic activation and development. In G. Czihak (Ed.), *The Sea Urchin Embryo*. Springer-Verlag, Berlin, pp. 148-169.
- ITO, T. (1960). On the culture of mixohaline rotifer *Brachionus plicatilis* O. F. MÜLLER in the sea water. (Jap.; Engl. summary.) *Rep. Fac. Fish. prefect. Univ. Mie*, **3**, 708-740.
- ITO, T. (1970). The biology of harpacticoid copepod *Tigriopus japonicus* MORI. *J. Fac. Sci. Hokkaido Univ.* (Ser. 6), **17**, 474-500.
- IVANCHENKO, L. A. and IVANCHENKO, O. F. (1969). Transition to active feeding by larval and juvenile White sea herring (*Clupea pallasii* NATIO *Maris-albi* BERG) in artificial conditions. *Dokl. Biol. Sci.*, **184**, 207-209.
- IVKER, F. B. (1972). A hierarchy of histo-incompatibility in *Hydractinia echinata*. *Biol. Bull. mar. biol. Lab., Woods Hole*, **143**, 162-174.
- IVLEV, V. S. (1961). *Experimental Ecology of the Feeding of Fishes*, Yale University Press, New Haven.
- IVLEVA, I. V. (1969). *Biological Principles and Methods of Mass Culture and Food Invertebrates* (Russ.), 'Nauka' Publishing House, Moscow.
- IWASAKI, H. (1973). Problems in the cultivation and mass culture of marine copepods. *Bull. Plankton Soc. Japan*, **20**, 72-73.
- IWATA, K. S. (1948). Artificial discharge of reproductive substances by K-salts injection in *Mactra veneriformis*. (Jap.) *Bull. Jap. Soc. scient. Fish.*, **13**, 188-192.
- IWATA, K. S. (1949a). Spawning of *Mytilus edulis*. 1. Discharging process of reproductive substances from genital organ. (Jap.) *Bull. Jap. Soc. scient. Fish.*, **15**, 439-442.
- IWATA, K. S. (1949b). Spawning of *Mytilus edulis*. 2. Discharge by electric stimulation. (Jap.) *Bull. Jap. Soc. scient. Fish.*, **15**, 443-446.
- IWATA, K. S. (1950). A method of determining the sex of sea urchins and of obtaining eggs by electric stimulation. *Annotnes zool. jap.*, **23**, 39-42.
- IWATA, K. S. (1951a). Spawning of *Mytilus edulis*. 5. A method to obtain mature eggs from mantle piece. (Jap.) *Bull. Jap. Soc. scient. Fish.*, **17**, 15-18.
- IWATA, K. S. (1951b). Spawning of *Mytilus edulis*. 7. Acid-inhibition of spawning of KCl. (Jap.) *Bull. Jap. Soc. scient. Fish.*, **17**, 91-93.
- IWATA, K. S. (1951c). Spawning of *Mytilus edulis*. 8. Comparison of inducing abilities of spawning among salts of alkali metals and alkali earth metals. (Jap.) *Bull. Jap. Soc. scient. Fish.*, **17**, 94-95.
- IWATA, K. S. (1951d). Spawning of *Mytilus edulis*. 9. Mechanism of spawning by temperature rise. (Jap.) *Bull. Jap. Soc. scient. Fish.*, **17**, 96-97.
- IWATA, K. S. (1952a). Spawning of *Mytilus edulis*. 6. Discharge by alkali treatment. (Jap.) *Bull. Jap. Soc. scient. Fish.*, **17**, 157-160.
- IWATA, K. S. (1952b). Mechanism of egg maturation in *Mytilus edulis*. (Jap.) *Biol. J. Okayama Univ.*, **1**, 1-11.
- IWATA, K. S. (1962). A simplified electric method of determining the sex of sea urchins. *Zool. Mag., Tokyo*, **71**, 301-302.
- IWATA, K. S. and FUKASE, H. (1964). Artificial spawning in sea urchins by acetylcholine. *Biol. J. Okayama Univ.*, **10**, 51-56.
- JACOBI, E. F. and BAAS BECKING, L. G. M. (1933). Salt antagonism and effect of concentration in nauplii of *Artemia salina* L. *Tijdschr. ned. dierk. Vereen.*, **3**, 145-167.
- JACOBS, J. (1961). Laboratory cultivation of the marine copepod *Pseudodiaptomus coronatus* WILLIAMS. *Limnol. Oceanogr.*, **6**, 443-446.
- JÄGERSTEN, G. (1940). Die Abhängigkeit der Metamorphose vom Substrat des Biotops bei *Protodrilus*. *Ark. Zool.*, **32A**, 1-12.
- JARVIS, C. and MORRIS, D. (1960). Length of life of mammals in captivity at the London Zoo in Whipsnade Park. *Int. Zoo Yb.*, **2**, 288-299.
- JEBRAM, D. (1968). A cultivation method for saltwater Bryozoa and an example for experimental biology. *Atti Soc. ital. Sci. nat.*, **108**, 119-128.
- JEBRAM, D. (1969). Bryozoen als Holzschädlinge im Brackwasser. *Kieler Meeresforsch.*, **25**, 224-231.

- JEBRAM, D. (1970). Preliminary experiments with Bryozoa in a simple apparatus for producing continuous water currents. *Helgoländer wiss. Meeresunters.*, **20**, 278-292.
- JEBRAM, D. (1973). Preliminary observations on the influences of food and other factors on the growth of Bryozoa. With the description of a new apparatus for cultivation of sessile plankton feeders. *Kieler Meeresforsch.*, **29**, 50-57.
- JEBRAM, D. (in press). Monster zooids and double polypides in *Cryptosula pallasiana* (Bryozoa, Cheilostomata Ascophora). *Helgoländer wiss. Meeresunters.*, **29**.
- JENNINGS, H. S. (1907). Behavior of the starfish, *Asterias forreri* DE LORIO. *Univ. Calif. Publ. Zool.*, **4**, 53-185.
- JENNINGS, J. B. (1957). Studies on feeding, digestion, and food storage in free-living flatworms (Platyhelminthes: Turbellaria). *Biol. Bull. mar. biol. Lab., Woods Hole*, **112**, 63-80.
- JENNINGS, R. H. and WHITAKER, D. M. (1941). The effect of salinity upon the rate of exocystment of *Artemia salina*. *Biol. Bull. mar. biol. Lab., Woods Hole*, **80**, 194-201.
- JERDE, G. W. and LASKER, R. (1966). Molting of euphausiid shrimps: shipboard observations. *Limnol. Oceanogr.*, **11**, 120-124.
- JHINGRAN, V. G. (1969). Review of the present status of knowledge on induced breeding of fishes and problems for future research. *FAO/UNDP Regional Seminar on Induced Spawning of Cultivated Fishes, India*.
- JHINGRAN, V. G. and GOPALAKRISHNAN, V. (1974). Catalogue of cultivated aquatic organisms. *F.A.O. Fish. Biol. tech. Pap.*, **130**, 1-83.
- JØRGENSEN, C. B. (1955). Quantitative aspects of filter feeding in invertebrates. *Biol. Rev.*, **30**, 391-454.
- JOHANNES, R. E. (1965). Influence of marine protozoa on nutrient regeneration. *Limnol. Oceanogr.*, **10**, 434-442.
- JOHANNES, R. E., ALBERTS, J., D'ELLA, C., KINZIE, R. A., POMEROY, L. R., SOTTILE, W. and WIEBE, W. (1972). The metabolism of some coral reef communities: a team study of nutrient and energy flux at Eniwetok. *BioScience*, **22**, 541-543.
- JOHANSEN, A. C. and KROGH, A. (1914). The influence of temperature and certain other factors upon the rate of development of the eggs of fishes. *Publ. Circ. Const. Cons. perm. int. Explor. Mer*, **68**, 1-44.
- JOHN, D. D. (1938). Crinoidea. *'Discovery' Rep.*, **18**, 121-222.
- JOHN, D. D. (1939). A viviparous synaptid holothurian from New Zealand. *Ann. Mag. nat. Hist. (Ser. 11)*, **4**, 315-319.
- JOHNSON, B. W. (1969). Maintenance of harbor seals (*Phoca vitulina*) in aquarium quarters. In *Proceedings of the 6th Annual Conference on Biological Sonar and Diving Mammals*. Stanford Research Institute, Menlo Park, California. pp. 49-54.
- JOHNSON, M. C. and FIELDING, J. R. (1956). Propagation of the white shrimp, *Penaeus setiferus* (LINN.), in captivity. *Tulane Stud. Zool.*, **4**, 175-190.
- JOHNSON, M. L., FISCUS, C. H., OSTENSON, B. T. and BARBOUR, M. L. (1966). Marine mammals. In N. J. Wilimovsky (Ed.), *Environment of the Cape Thompson Region, Alaska*. U.S. Atomic Energy Commn, Oak Ridge, Tenn. pp. 877-924.
- JOHNSON, M. W. (1943). Studies on the life history of the marine annelid *Nereis vexillosa*. *Biol. Bull. mar. biol. Lab., Woods Hole*, **84**, 106-114.
- JOHNSON, M. W. and OLSON, J. B. (1948). The life history and biology of a marine harpacticoid copepod, *Tisbe furcata* (BAIRD). *Biol. Bull. mar. biol. Lab., Woods Hole*, **95**, 320-332.
- JOHNSON, W. H. (1956). Nutrition of Protozoa. *A. Rev. Microbiol.*, **10**, 193-212.
- JONCH, A. (1965). Aquarama: exhibit of bottle-nosed dolphins. *Int. Zoo Yb.*, **7**, 59-61.
- JONES, A. J. (1972). An inexpensive apparatus for the large scale hatching of *Artemia salina* L. *J. Cons. int. Explor. Mer*, **34**, 351-356.
- JONES, D. A. and GABBOTT, P. A. (1976). Prospects for the use of microcapsules as food particles for marine particulate feeders. In J. R. Nixon (Ed.), *Microencapsulation. Drugs and the Pharmaceutical Sciences*, Vol. 3. Dekker, New York. pp. 77-91.

- JONES, D. A., MÖLLER, T. H., CAMPBELL, R. J., MUNFORD, J. G. and GABBOTT, P. A. (in press). Studies on the design and acceptability of microencapsulated diets for marine particulate feeders. I. Crustacea. In G. Persoone and E. Jaspers (Eds), *Tenth European Marine Biology Symposium*. Ostend, Belgium, 1975.
- JONES, D. A., MUNFORD, J. G., and GABBOTT, P. A. (1974). Microcapsules as artificial particles for aquatic filter feeders. *Nature, Lond.*, **247**, 233-235.
- JONES, L. M. (1954). *Veterinary Pharmacology and Therapeutics*, Iowa State College Press, Ames.
- JONES, L. W., HILDEBRANDT, A. C., RIKER, A. J. and WU, J. H. (1960). Growth of somatic tobacco cells in microculture. *Am. J. Bot.*, **47**, 468-475.
- JONES, M. L. (1970). History of marine mammals in captivity with notes on their longevity. In *Proceedings of the 7th Annual Conference on Biological Sonar and Diving Mammals*. Stanford Research Institute, Menlo Park, California. pp. 81-89.
- JONES, W. C. (1957). The contractility and healing behaviour of pieces of *Leucosolenia complicata*. *Q. Jl microsc. Sci.*, **98**, 203-217.
- JONES, W. C. (1971). Spicule formation and corrosion in recently metamorphosed *Sycon ciliatum* (O. FABRICIUM). In D. J. Crisp (Ed.), *Fourth European Marine Biology Symposium*. Cambridge University Press, London. pp. 301-320.
- JOSEPHSON, R. K. and MACKIE, G. O. (1965). Multiple pacemakers and the behaviour of the hydroid *Tubularia*. *J. exp. Biol.*, **43**, 293-332.
- JUST, E. E. (1922). On rearing sexually mature *Platynereis megalops* from eggs. *Am. Nat.*, **56**, 471-478.
- KABATA, Z. (1970). Crustacea as enemies of fishes. In S. F. Snieszko and H. A. Axelrod (Eds), *Diseases of Fishes*. Vol. I. T. F. H. Publ. Inc., Jersey City. pp. 128-133.
- KÄHLER, H. H. (1970). Über den Einfluß der Adaptationstemperatur und des Salzgehaltes auf Hitze- und Gefrierresistenz von *Enchytraeus albidus* (Oligochaeta). *Mar. Biol.*, **5**, 315-324.
- KÄNDLER, R. (1933). Die Kultur der Auster. In E. Abderhalden (Ed.), *Handbuch der biologischen Arbeitsmethoden*, Band 1. Methoden der Meerwasserbiologie. Urban & Schwarzenberg, Berlin. pp. 599-716.
- KAGAN, I. G., SHORT, R. B. and NEZ, M. M. (1954). Maintenance of *Schistosomatium douthitti* (CORT, 1914) in the laboratory (Trematoda: Schistosomatidae). *J. Parasit.*, **40**, 424-439.
- KAHAN, D. and APPEL, Z. (in press). The value of *Panagrellus* sp. (Nematoda) as food for fish. In G. Persoone and E. Jaspers (Eds), *Tenth European Marine Biology Symposium*. Ostend, Belgium, 1975.
- KAHAN, D., ZALCMAN, D., HOROWITZ, L., ORON, R. and REIBENBACH, Z. (in press). The cultivation of marine Protozoa (ciliates). In G. Persoone and E. Jaspers (Eds), *Tenth European Marine Biology Symposium*. Ostend, Belgium, 1975.
- KAUSSLING, K.-E. (1963). Die phototropische Reaktion der Zoide von *Bugula avicularia* L. *Z. vergl. Physiol.*, **46**, 541-594.
- KAKINUMA, Y. (1966a). Life cycle of a hydrozoan, *Sarsia tubulosa* (SARS). *Bull. biol. Stn Asamushi*, **12**, 207-210.
- KAKINUMA, Y. (1966b). Life cycle of a hydrozoan, *Campanulina* type, or *Aequorea coerulescens* BRANDT. *Bull. biol. Stn Asamushi*, **12**, 211-218.
- KALLMAN, K. D. (1962). Gynogenesis in the teleost, *Molliensia formosa* (GIRARD), with a discussion of the detection of parthenogenesis in vertebrates by tissue transplantation. *J. Genet.*, **58**, 7-24.
- KANATANI, H. (1964). Spawning of starfish: action of gamete-shedding substance obtained from radial nerves. *Science, N. Y.*, **146**, 1177-1179.
- KANATANI, H. and NOUMURA, T. (1962). On the nature of active principles responsible for gamete-shedding in the radial nerves of starfishes. *J. Fac. Sci. Tokyo Univ.* (Sect. 4), **9**, 403-416.
- KANAZAWA, A. (1969). On the vitamin B of a diatom, *Chaetoceros simplex*, as the diet for the larvae of marine animals. (Jap.) *Mem. Fac. Fish. Kagoshima Univ.*, **18**, 93-97.
- KANAZAWA, A., SHIMAYA, M., KAWASAKI, M. and KASHIWADA, K. (1970). Nutritional requirements of prawn. I. Feeding on artificial diet. *Bull. Jap. Soc. scient. Fish.*, **36**, 949-954.
- KANAZAWA, A., TANAKAWA, N., TESHIMA, S. and KASHIWADA, K. (1971). Nutritional requirements of prawn. II. Requirements for sterols. *Bull. Jap. Soc. scient. Fish.*, **37**, 211-215.

- KANESHIRO, E. S., DUNHAM, P. B. and HOLZ, G. G., JR. (1969a). Osmoregulation in a marine ciliate, *Miamiensis avidus*. I. Regulation of inorganic ions and water. *Biol. Bull. mar. biol. Lab., Woods Hole*, **136**, 63-75.
- KANESHIRO, E. S., HOLZ, G. G., JR. and DUNHAM, P. B. (1969b). Osmoregulation in a marine ciliate, *Miamiensis avidus*. II. Regulation of intracellular free amino acids. *Biol. Bull. mar. biol. Lab., Woods Hole*, **137**, 161-169.
- KAN-NO, H. and KIKUCHI, S. (1962). On the rearing of *Anadara broughtonii* (SCHRENK) and *Haliotis discus hannai* INO. *Bull. Mar. Stn. Asamushi*, **11**, 71-76.
- KANWISHER, J. and LEIVESTAD, H. (1957). Thermal regulation in whales. *Norsk Hvalfangsttid.*, **1**, 1-5.
- KANWISHER, J. and SUNDNES, G. (1966). Thermal regulation in cetaceans. In K. S. Norris (Ed.), *Whales, Dolphins, and Porpoises*. University of California Press, Berkeley. pp. 397-409.
- KANWISHER, J. W. and WAINWRIGHT, S. A. (1967). Oxygen balance in some reef corals. *Biol. Bull. mar. biol. Lab., Woods Hole*, **133**, 378-390.
- KARANDE, A. A. (1974a). *Balanus variegatus* DARWIN: The laboratory reared larvae compared with *Balanus amphitrite amphitrite* DARWIN (Cirripedia). *Crustaceana*, **26**, 229-332.
- KARANDE, A. A. (1974b). Larval development of the barnacle *Tetraclitella karandei* reared in the laboratory. *Biol. Bull. mar. biol. Lab., Woods Hole*, **146**, 249-257.
- KARANDE, A. A. and THOMAS, M. K. (1971). Laboratory rearing of *Balanus amphitrite communis* D. *Curr. Sci.*, **40**, 109-110.
- KARBE, L. (1972). Marine Hydroiden als Testorganismen zur Prüfung der Toxizität von Abwasserstoffen. Die Wirkung von Schwermetallen auf Kolonien von *Eirene viridula*. *Mar. Biol.*, **12**, 316-328.
- KARLSON, P. and BUTENANDT, A. (1959). Pheromones (ectohormones) in insects. *A. Rev. Ent.*, **4**, 39-48.
- KASAHARA, S., HIRANO, R. and OHSHIMA, Y. (1960). A study on the growth and rearing methods of black porgy, *Mylio macrocephalus* (BASILEWSKY). (Jap.; Engl. summary.) *Bull. Jap. Soc. scient. Fish.*, **26**, 239-244.
- KASAHARA, S., ONBÉ, T. and KAMIGAKI, M. (1975). Calanoid copepod eggs in sea-bottom muds. III. Effects of temperature, salinity and other factors on the hatching of resting eggs of *Tortanus forcipatus*. *Mar. Biol.*, **31**, 31-35.
- KASAHARA, S., UYE, S. and ONBÉ, T. (1974). Calanoid copepod eggs in sea-bottom muds. *Mar. Biol.*, **26**, 167-171.
- KATONA, S. K. (1970). Growth characteristics of the copepods *Eurytemora affinis* and *E. herdmani* in laboratory cultures. *Helgoländer wiss. Meeresunters.*, **20**, 373-384.
- KATONA, S. K. (1971). The developmental stages of *Eurytemora affinis* (POPPE, 1880) (Copepoda, Calanoida) raised in laboratory cultures, including a comparison with the larvae of *Eurytemora americana* WILLIAMS, 1906, and *Eurytemora herdmani* THOMPSON & SCOTT, 1897. *Crustaceana*, **21**, 5-20.
- KATONA, S. K. and MOODIE, C. F. (1969). Breeding of *Pseudocalanus elongatus* in the laboratory. *J. mar. biol. Ass. U.K.*, **49**, 743-747.
- KAUFMAN, G. W., SINIFF, D. B. and REICHLER, R. (1975). Colony behaviour of Weddell seals, *Leptonychotes weddelli*, at Hutton cliffs, Antarctica. *Rapp. P.-v. Réun. Cons. int. Explor. Mer*, **169**, 228-246.
- KAUSCH, H. (1973). Breeding habits of the major cultivated fishes of EIFAC region and problems of sexual maturation in captivity. *EIFAC Workshop on Controlled Reproduction of Cultivated Fishes*, Hamburg, 1973.
- KAWAGUTI, S. (1941). On the physiology of coral reefs. V. Tropisms of coral planulae, considered as a factor of distribution of the reefs. *Palao trop. biol. Stn Stud.*, **2**, 319-328.
- KAWAMURA, K. (1973). (Quoted in LAWRENCE, 1975.)
- KAWAMURA, K. and TAKI, J. (1965). Ecological studies on the sea urchin, *Strongylocentrotus intermedius*, on the coast of Funadomari, in the North region of Rebun Island. (Jap.; Engl. abstract.) *Sci. Rept. Hokkaido Fisheries Expt. Sta.*, **4**, 22-40.
- KAY, D. G. (1972). The nutrition and energy relations of the polychaete *Nereis virens* SARS. Ph.D. Thesis, University of London.

- KAY, D. G. and BRAFIELD, A. E. (1973). The energy relations of the polychaete *Neanthes (=Nereis) virens* (SARS). *J. Anim. Ecol.*, **42**, 673-692.
- KELLER, S. E., HUTNER, S. H. and KELLER, D. E. (1968). Rearing the colorless marine dinoflagellate *Cryptothecodinium cohnii* for use as a biochemical tool. *J. Protozool.*, **15**, 792-795.
- KENK, R. (1940). The reproduction of *Dugesia tigrina* (GIRARD). *Am. Nat.*, **74**, 471-475.
- KENSLE, C. B. (1970). The potential of lobster culture. *Am. Fish Farmer Wild Agric. News*, **1** (11), 8-13.
- KENYON, K. W. (1965). Food of harbor seals at Amchitka Island, Alaska. *J. Mammal.*, **46**, 103-104.
- KENYON, K. W., SCHEFFER, V. B. and CHAPMAN, D. G. (1954). A population study of the Alaska fur-seal herd. *Spec. scient. Rep. U.S. Fish Wildl. Serv.* (Ser. B), **12**, 1-77.
- KERNEIS, A. (1960). Contribution à l'étude faunistique et écologique des herbiers de Posidonies de la région de Banyuls. *Vie Milieu*, **11**, 145-187.
- KESSLER, M. (1963). Entwicklung von *Lanice conchilega* (PALLAS) mit besonderer Berücksichtigung der Lebensweise. *Helgoländer wiss. Meeresunters.*, **8**, 425-476.
- KESTEVEN, G. L. and JOB, T. J. (1957). Shrimp culture in Asia and the Far East. A preliminary review. *Proc. Gulf Caribb. Fish. Inst.*, **10**, 49-68.
- KEYES, M. C. (1967). Pup nutrition. In *Fur Seal Investigations, 1966*. Marine Mammal Biological Laboratory, Seattle, Bur. COMM. Fish. Manuscript Report, 121-128.
- KEYES, M. C. (1968). The nutrition of pinnipeds. In R. J. Harrison, R. C. Hubbard, R. S. Peterson, C. E. Rice and R. J. Schusterman (Eds), *The Behavior and Physiology of Pinnipeds*. Appleton-Century-Crofts, New York. pp. 359-395.
- KHLEBOVITCH, V. V. (1963). On the biology of *Nereis virens* SARS in the Kandalaksha Bay of the White Sea. (Russ.; Engl. summary.) *Trudy kandal. gosudarst. Zypov. pt. 4, Trudy belom. biol. Sta. mosk. gosudarst. Univ.*, **2**, 250-257.
- KIDDER, G. W. (1941). Growth studies on ciliates. The acceleration and inhibition of ciliates grown in biochemically conditioned medium. *Physiol. Zool.*, **14**, 209-226.
- KIDDER, G. W. (1951). Nutrition and metabolism of Protozoa. *A. Rev. Microbiol.*, **5**, 139-156.
- KIDDER, G. W. (1967). Protozoa. In M. Florkin and B. T. Scheer (Eds), *Chemical Zoology*, Vol. I. Academic Press, New York. pp. 1-912.
- KIDDER, G. W. and DEWEY, V. C. (1951). The biochemistry of ciliates in pure culture. In A. Lwoff (Ed.), *Biochemistry and Physiology of Protozoa*, Vol. I. Academic Press, New York. pp. 323-400.
- KIKUCHI, S. (1964). Studies on the culture of abalone *Haliotis discus hannai* INO. *Peking Symposium*, GEN 041, 185-202.
- KIKUCHI, S. and UKI, N. (1974a). Technical study on artificial spawning of abalone, genus *Haliotis*. I. Relation between water temperature and advancing sexual maturity of *Haliotis discus hannai* INO. *Bull. Tohoku Reg. Fish. Res. Lab.*, **49**, 69-78.
- KIKUCHI, S. and UKI, N. (1974b). Technical study on artificial spawning of abalone, genus *Haliotis*. II. Effect of irradiated sea water with ultraviolet rays on inducing to spawn. *Bull. Tohoku Reg. Fish. Res. Lab.*, **49**, 79-86.
- KILIAN, E. F. (1952). Wasserströmung und Nahrungsaufnahme beim Süßwasserschwamm *Ephydatia fluviatilis*. *Z. vergl. Physiol.*, **34**, 407-447.
- KILIAN, E. F. (1964). Zur Biologie der einheimischen Spongilliden. Ergebnisse und Probleme. *Zool. Beitr.*, **10**, 85-159.
- KIM, J. D. and KOO, J. H. (1973). Studies on the seedling production of the ark, *Anadara broughtonii* (SCHRENK) in tank. I. *Bull. Fish. Res. Dev. Agency, Pusan*, **11**, 71-78.
- KING, C. E. (1962). Some aspects of the ecology of psammolittoral nematodes in the northern Gulf of Mexico. *Ecology*, **43**, 515-523.
- KING, J. (1964). *Seals of the World*, British Museum (Nat. Hist.), London.
- KINGSTON, P. (1974). Some observations on the effects of temperature and salinity upon the growth of *Cardium edule* and *Cardium glaucum* larvae in the laboratory. *J. mar. biol. Ass. U.K.*, **54**, 309-317.
- KINNE, O. (1953). Zur Biologie und Physiologie von *Gammarus duebeni* LILLJ. I. *Z. wiss. Zool.*, **157**, 427-491.
- KINNE, O. (1954). Experimentelle Untersuchungen über den Einfluß des Salzgehaltes auf die Hitzeresistenz von Brackwassertieren. *Zool. Anz.*, **152**, 10-16.

- KINNE, O. (1956). Über den Einfluß des Salzgehaltes und der Temperatur auf Wachstum, Form und Vermehrung bei dem Hydroidpolypen *Cordylophora caspia* (PALLAS), Athecata, Clavidae. *Zool. Jb. (Allg. Zool. Physiol. Tiere)*, **66**, 565-638.
- KINNE, O. (1958). Über die Reaktion erbgleichen Coelenteratengewebes auf verschiedene Salzgehalts- und Temperaturbedingungen. *Zool. Jb. (Allg. Zool. Physiol. Tiere)*, **67**, 407-486.
- KINNE, O. (1962). Irreversible nongenetic adaptation. *Comp. Biochem. Physiol.*, **5**, 265-282.
- KINNE, O. (1970). Temperature: Animals. Invertebrates. In O. Kinne (Ed.), *Marine Ecology*, Vol. I, Environmental Factors, Part 1. Wiley, London. pp. 407-514.
- KINNE, O. (1971). Salinity: Animals. Invertebrates. In O. Kinne (Ed.), *Marine Ecology*, Vol. I, Environmental Factors, Part 2. Wiley, London. pp. 821-955.
- KINNE, O. (1975). Orientation in space: Animals. Mammals. In O. Kinne (Ed.), *Marine Ecology*, Vol. II, Physiological Mechanisms, Part 2. Wiley, London. pp. 709-916.
- KINNE, O. (Ed.) (in press). *Diseases of Marine Animals*, Wiley, London.
- KINNE, O. and AURICH, H. (Eds) (1967). First European Symposium on Marine Biology. *Helgoländer wiss. Meeresunters.*, **15**, 1-669.
- KINNE, O. and BULNHEIM, H.-P. (Eds) (1970). Cultivation of marine organisms and its importance for marine biology. *Helgoländer wiss. Meeresunters.*, **20**, 1-721.
- KINNE, O. and KINNE, E. M. (1962). Rates of development in embryos of a cyprinodont fish exposed to different temperature-salinity-oxygen combinations. *Can. J. Zool.*, **40**, 231-253.
- KINNE, O. and PAFFENHÖFER, G.-A. (1965). Hydranth structure and digestion rate as a function of temperature and salinity in *Clava multicornis* (Cnidaria, Hydrozoa). *Helgoländer wiss. Meeresunters.*, **12**, 329-341.
- KINNE, O. and PAFFENHÖFER, G.-A. (1966). Growth and reproduction as a function of temperature and salinity in *Clava multicornis* (Cnidaria, Hydrozoa). *Helgoländer wiss. Meeresunters.*, **13**, 62-72.
- KINNE, O. and ROTTHAUWE, H.-W. (1952). Biologische Beobachtungen und Untersuchungen über die Blutkonzentration an *Heteropanope tridentatus* MAITLAND (Dekapoda). *Kieler Meeresforsch.*, **8**, 212-217.
- KINOSHITA, T., SIBUYA, S. and SIMIZU, Z. (1943). Induction of spawning of the scallop, *Pecten (Patinopecten) yessoensis* JAY. (Jap.) *Bull. Jap. Soc. scient. Fish.*, **11**, 168-170.
- KIRBY, H. (1950). *Material and Methods in the Study of Protozoa*, University of California Press, Berkeley.
- KIRK, R. G. (1972). A review of recent developments in *Tilapia* culture with special reference to fish farming in the heated effluents of power stations. *Aquaculture*, **1**, 45-60.
- KISCH, B. S. (1958). *Astropecten irregularis* precieux auxiliaire du malacologiste. *Bull. Cent. Étud. Rech. scient., Biarritz*, **2**, 9-15.
- KITABAYASHI, K., KURATA, H., SHUDO, K., NAKAMURA, K. and ISHIKAWA, S. (1971a). Studies on formula feed for Kuruma prawn. I. On the relationship among glucosamine, phosphorus and calcium. (Jap.; Engl. abstract.) *Bull. Tokai reg. Fish. Res. Lab.*, **65**, 91-107.
- KITABAYASHI, K., SHUDO, K., NAKAMURA, K. and ISHIKAWA, S. (1971b). Studies on formula feed for Kuruma prawn. II. On the utilization values of glucose. (Jap.; Engl. abstract.) *Bull. Tokai reg. Fish. Res. Lab.*, **65**, 109-118.
- KITABAYASHI, K., SHUDO, K., NAKAMURA, K. and ISHIKAWA, S. (1971c). Studies on formula feed for Kuruma prawn. III. On the growth-promoting effects of both arginine and methionine. (Jap.; Engl. abstract.) *Bull. Tokai reg. Fish. Res. Lab.*, **65**, 119-127.
- KITABAYASHI, K., SHUDO, K., NAKAMURA, K. and ISHIKAWA, S. (1971d). Studies on formula feed for Kuruma prawn. V. On the growth-promoting effects of protein level in a diet and re-examination of ingredients used. (Jap.; Engl. abstract.) *Bull. Tokai reg. Fish. Res. Lab.*, **65**, 139-147.
- KITAJIMA, C. (1973). Experimental trials on mass culture of copepods. *Bull. Plankton Soc. Japan*, **20**, 54-60.
- KITAMORI, R. (1961). The relation between the genus *Capitella*, polychaetous annelids, and pollution. (Jap.; Engl. summary.) *Bull. Naikai reg. Fish. Res. Lab.*, **13**, 1-10.
- KITAKA, J. (1971). Rearing methods of the prawn, *Penaeus japonicus*. (Jap.) In T. Imai (Ed.), *Culture of Inshore Fishes*. Koseisha-Koseikaku, Tokyo. pp. 344-408.

- KJERSKOG-AGERSBERG, H. P. (1918). Bilateral tendencies and habits in the twenty-rayed starfish *Pycnopodia helianthoides* (STIMPSON). *Biol. Bull. mar. biol. Lab., Woods Hole*, **35**, 232-254.
- KLEPAL, W. and BARNES, H. (1974). Regeneration of the penis in *Balanus balanoides* (L.). *J. exp. mar. Biol. Ecol.*, **16**, 205-211.
- KLIMA, E. F., BARRET, I. and KINNEAR, J. E. (1962). Artificial fertilization of the eggs, and rearing and identification of the larvae of the anchoveta, *Cetengraulis mysticetus*. *Bull. inter-Am. trop. Tuna Commn.*, **6**, 155-178.
- KLÖCKNER, K. (1971). Experimentell-ökologische Untersuchungen am Dreikantröhrenwurm *Pomatoceros triqueter*. Jahresbericht 1971 der Biologischen Anstalt Helgoland, Hamburg.
- KLÖCKNER, K. (1976). Zur Ökologie von *Pomatoceros triqueter* (LINNE 1758) (Serpulidae, Polychaeta). Ph.D Thesis, University of Tübingen.
- KLÖS, H.-G. (1962). Aquatic exhibits at West Berlin Zoo. *Int. Zoo Yb.*, **4**, 38-40.
- KLÖS, H.-G. (1974). Aquatic exhibits at West Berlin Zoo. *Aquatic Mammals*, **2**, 7-10.
- KLYUCHAREV, K. V. (1948). On the question of the reproduction and development of some copepods (Copepoda) of the Black Sea. (Russ.) *Trans. Acad. Sci. USSR*, **1**, unpaginated.
- KNIGHT, A. P. (1916). Lobster sanctuaries and hatching ponds. An investigation of the Long Beach lobster pond, Digby County, Nova Scotia in 1914. *Contr. Can. Biol. Fish.*, **1916**, 41-54.
- KNIPOWITSCH, N. (1891). Zur Entwicklungsgeschichte von *Olione limacina*. *Biol. Zbl.*, **11**, 300-303.
- KNOWLTON, R. E. (1970). Abbreviated larval development in *Alpheus heterochaelis* SAY (Crustacea, Decapoda, Caridea) from coastal North Carolina. *Am. Zool.*, **10**, 542-543.
- KNOWLTON, R. E. (1971). Effects of environmental factors on the larval development of *Alpheus heterochaelis* SAY and *Palaemonetes vulgaris* (SAY) (Crustacea Decapoda Caridea), with ecological notes on larvae and adult Alpheidae and Palaemonidae. *Diss. Abstr. Int.*, **31**, unpaginated.
- KNOWLTON, R. E. (1972). Effects of temperature and salinity on the larval development of *Alpheus heterochaelis* SAY (Crustacea, Decapoda, Caridea). *Am. Zool.*, **12**, 725.
- KNOWLTON, R. E. (1973). Larval development of the snapping shrimp *Alpheus heterochaelis* SAY, reared in the laboratory. *J. nat. Hist.*, **7**, 273-306.
- KOBAYASHI, S. and YUKI, R. (1952). Artificial breeding of pearl oyster, *Pinctada martensii*, in tanks. (Jap.) *Bull. Jap. Soc. scient. Fish.*, **17**, 65-72.
- KOEHLER, R. (1926). Echinodermata echinoidea. *Scient. Rep. Australas. Antarct. Exped.* (Ser. C), **8**, 1-134.
- KOGA, F. (1973). Life history of copepods especially of nauplius larvae ascertained mainly with cultivation of animals. *Bull. Plankton Soc. Japan*, **20**, 30-40.
- KOMAKI, Y. (1957). On the 'esada' (*Euphausia pacifica* H. J. HANSEN) fishery in the vicinity of the Ojika Peninsula. (Jap.) *Inf. Bull. Whales Res. Inst.*, **60**, 10-17.
- KOMAKI, Y. (1966). Technical notes on keeping euphausiids live in the laboratory, with a review of experimental studies on euphausiids. *Inf. Bull. Planktol. Japan*, **13**, 95-102.
- KOOYMAN, G. L. (1967). An analysis of some behavioral and physiological characteristics related to diving in the Weddell seal. *Antarct. Res. Ser.*, **11**, 227-261.
- KOOYMAN, G. L. (1975). Physiology of freely diving Weddell seals. *Rapp. P.-v. Réun. Cons. int. Explor. Mer*, **169**, 441-444.
- KOOYMAN, G. L. and DRABEK, C. M. (1968). Observations on milk, blood, and urine constituents of the Weddell seal. *Physiol. Zool.*, **41**, 187-194.
- KOPAC, M. J. (1941). Disintegration of the fertilization membrane of *Arbacia* by the action of an 'enzyme'. *J. cell. comp. Physiol.*, **18**, 215-220.
- KOREN, J. and DANIELSSEN, D. C. (1857). Observations on the development of the star-fishes. *Ann. Mag. nat. Hist.*, **20**, 132-136.
- KORRINGA, P. (1952). Recent advances in oyster biology. *Q. Rev. Biol.*, **27**, 266-308, 339-365.
- KORSCHULT, E. (1882). Über Bau und Entwicklung des *Dinophilus apatris*. *Z. wiss. Zool.*, **37**, 315-702.
- KOTTHAUS, A. (1939). Zuchtversuche mit Heringslarven (*Clupea harengus* L.). *Helgoländer wiss. Meeresunters.*, **1**, 349-358.

- KOZLOFF, E. N. (1969). Monoxenic cultivation of an acoel turbellarian, *Parotocelis luteola*. *J. exp. mar. Biol. Ecol.*, **3**, 224-230.
- KOZLOFF, E. N. (1972). Selection of food, feeding and physical aspects of digestion in the acoel turbellarian *Otocelis luteola*. *Trans. Am. micros. Soc.*, **91**, 556-565.
- KRAMER, D. and ZWEIFEL, J. R. (1970). Rearing and growth of anchovy larvae (*Engraulis mordax* GIRARD) as influenced by temperature. *Rep. Calif. coop. oceanic Fish. Invest.*, **14**, 84-87.
- KREMER, B. P. (1975). $^{14}\text{CO}_2$ -Fixation by the endosymbiotic alga *Platymonas convolutae* within the turbellarian *Convoluta roscoffensis*. *Mar. Biol.*, **31**, 219-226.
- KRETCHMER, N. and SUNSHINE, P. (1967). Intestinal disaccharidase deficiency in the sealion. *Gastroenterology*, **53**, 123-129.
- KRISHNAN, S. (1971). Autoradiographic studies on sugar transport in the sea cucumber *Holothuria scabra*. *Mar. Biol.*, **10**, 189-191.
- KRIŽENEČKY, J. (1916). Beitrag zum Studium der Bedeutung osmotischer Verhältnisse des Mediums für Organismen. Versuche an Würmern Enchytraeiden. *Pflügers Arch. ges. Physiol.*, **163**, 325-354.
- KROGH, A. (1939). *Osmotic Regulation in Aquatic Mammals*, Cambridge University Press.
- KROLL, W. R. (1962). Experience with Sernylan in zoo animals. *Int. Zoo Yb.*, **4**, 131-141.
- KRÜGER, F. (1958). Zur Atmungsphysiologie von *Arenicola marina* L. *Helgoländer wiss. Meeresunters.*, **6**, 193-201.
- KRÜGER, F. (1959). Zur Ernährungsphysiologie von *Arenicola marina* L. *Zool. Anz.*, **22** (Suppl.), 115-120.
- KRÜGER, F. (1962). Experimentelle Untersuchungen zur ökologischen Physiologie von *Arenicola marina*. *Kieler Meeresforsch.*, **18**, 93-96.
- KRÜGER, F. (1964a). Versuche über die Abhängigkeit der Atmung von *Arenicola marina* (Annelides Polychaeta) von Größe und Temperatur. *Helgoländer wiss. Meeresunters.*, **10**, 38-63.
- KRÜGER, F. (1964b). Messungen der Pumpfähigkeit von *Arenicola marina* L. im Watt. *Helgoländer wiss. Meeresunters.*, **11**, 70-91.
- KRÜGER, F. (1971). Bau und Leben des Wattwurmes *Arenicola marina*. *Helgoländer wiss. Meeresunters.*, **22**, 149-200.
- KUBO, K. (1951). Some observations on the development of the sea-star *Leptasterias ochotensis similispinus* (CLARK). *J. Fac. Sci. Hokkaido Univ.* (Ser. 6, Zool.), **10**, 97-105.
- KÜHLMANN, H. H. and KARST, H. (1967). Freiwasserbeobachtungen zum Verhalten von Tobiasfischschwärmen (Amnodytidae) in der westlichen Ostsee. *Z. Tierpsychol.*, **24**, 282-297.
- KÜHNHOLD, W. W. (1969). Der Einfluß wasserlöslicher Bestandteile von Rohölen und Rohölfraktionen auf die Entwicklung von Heringsbrut. *Ber. dt. wiss. komm. Meeresforsch.*, **20**, 165-171.
- KÜHNHOLD, W. W. (1972). The influence of crude oils on fish fry. In M. Ruivo (Ed.), *Marine Pollution and Sea Life*. Fishing News (Books), London. pp. 315-318.
- KUENEN, D. J. (1939). Systematical and physiological notes on the brine shrimp, *Artemia*. *Archs néerl. Zool.*, **3**, 365-449.
- KÜSTER, E. (1908). Eine kultivierbare Peridinee. *Arch. Protistenk.*, **11**, 351-362.
- KUHLMANN, H. (1975). Der Einfluß von Temperatur, Futter, Größe und Herkunft auf die sexuelle Differenzierung von Glasaalen (*Anguilla anguilla*). *Helgoländer wiss. Meeresunters.*, **27**, 139-155.
- KUNITSYN, YU. (1968). Apparatus for incubating pelagic eggs of fishes. (Russ.) *Ryb. Khoz.*, **44**, 6.
- KUNJU, M. M. (1970). Synopsis of biological data on the penaeid prawn *Solenocera indica* NATARAJ, 1945. *F.A.O. Fish. Rep.*, **57**, 1317-1333.
- KUO, C.-M., NASH, C. E. and SHEHADEH, Z. H. (1974a). A procedural guide to induce spawning in grey mullet (*Mugil cephalus* L.). *Aquaculture*, **3**, 1-14.
- KUO, C.-M., NASH, C. E. and SHEHADEH, Z. H. (1974b). The effects of temperature and photoperiod on ovarian development in captive grey mullet (*Mugil cephalus* L.). *Aquaculture*, **3**, 25-43.

- KUO, C.-M., SHEHADEH, Z. H. and NASH, C. E. (1973). Induced spawning of captive grey mullet (*Mugil cephalus* L.) females by injection of human chorionic gonadotropin (HCG). *Aquaculture*, **1**, 429-432.
- KUPELWIESER, H. (1906). Untersuchungen über den feineren Bau und die Metamorphose des Cyphonautes. *Zoologica*, **19**, 1-50.
- KURATA, H. (1956). On the rearing of larvae of the flatfish, *Liopsetta obscura*, in small aquaria. (Jap.) *Bull. Hokkaido reg. Fish. Res. Lab.*, **13**, 20-29.
- KURATA, H. (1959). Preliminary report on the rearing of the herring larvae. (Jap.) *Bull. Hokkaido reg. Fish. Res. Lab.*, **20**, 117-138.
- KUWATANI, Y. and NISHII, T. (1969). Effects of pH of culture water on the growth of the Japanese pearl oyster (*Pinctada fucata*). (Jap.; Engl. summary.) *Bull. Jap. Soc. scient. Fish.*, **35**, 342-350.
- KWASIKPUI, D. B. (1960). Suggested method for the maintenance of rotifer culture. *Turtlox News*, **38**, 267.
- LAALE, H. W. and MCCALLION, D. J. (1968). Reversible developmental arrest in the embryo of the Zebra fish *Brachydanio rerio*. *J. exp. Zool.*, **167**, 117-123.
- LACKEY, J. B. (1967). The microbiota of estuaries and their roles. In G. H. Lauff (Ed.), *Estuaries*. A.A.A.S., Washington, D.C. (*Publ. Am. Ass. Advmt Sci.*, **83**.) pp. 291-305.
- LADERMAN, A. D. and GUTTMAN, H. N. (1963). Induction of sexuality by alteration of photoperiod in the rotifer *Brachionus rubens* (*Monostyla quadridentata*). *J. exp. Zool.*, **152**, 5-11.
- LALLI, C. M. (1970). Structure and function of the buccal apparatus of *Clione limacina* (PHIPPS) with a review of feeding in gymnosomatous pteropods. *J. exp. mar. Biol. Ecol.*, **4**, 101-118.
- LALLI, C. M. (1972). Food and feeding of *Paedocione doliiformis* DANFORTH, a neotenous gymnosomatous pteropod. *Biol. Bull. mar. biol. Lab., Woods Hole*, **143**, 392-402.
- LALLI, C. M. and CONOVER, R. J. (1973). Reproduction and development of *Paedocione doliiformis*, and a comparison with *Clione limacina* (Opisthobranchia: Gymnosomata). *Mar. Biol.*, **19**, 13-22.
- LALLIER, R. (1964). Biochemical aspects of animalization and vegetalization in the sea urchin embryo. In M. Abercrombie and J. Brachet (Eds), *Advances in Morphogenesis*. Academic Press, New York. pp. 147-196.
- LALLIER, R. (1973). Changes in the differentiation of sea urchin larvae by action of a detergent upon the unsegmented egg. *Experientia*, **29**, 1022.
- LALLIER, R. (1975). Animalization and vegetalization. In G. Czihak (Ed.), *The Sea Urchin Embryo*. Springer-Verlag, Berlin. pp. 473-509.
- LAMBERT, R. J. (1935). Jellyfish. The difficulties of the study of their life cycle and other problems. *Essex Nat.*, **25**, 70-77.
- LAMPERT, K. (1889). Die während der Expedition S. M. S. 'Gazelle' 1874-1876 von Prof. Dr. Th. Studer gesammelten Holothurien. *Zool. Jb. Abt. Syst.*, **24**, 806-858. (*Zool. Jb. Neapel*, **1889**, 22.)
- LANDE, R. (1973). Food and feeding habits of plaice (*Pleuronectes platessa* L.) in Borgenfjorden, North-Trøndelag, Norway. *Norwegian J. Zool.*, **21**, 91-100.
- LANDENBERGER, D. E. (1968). Studies on selective feeding in the Pacific starfish *Pisaster* in southern California. *Ecology*, **49**, 1062-1075.
- LANDRY, M. R. (1976). The structure of marine ecosystems: an alternative. *Mar. Biol.*, **35**, 1-7.
- LARSON, G. (1970). A simple chamber for separating brine shrimp (*Artemia salina*) nauplii from unhatched eggs and empty egg cases. *Progve Fish Cult.*, **32**, 208.
- LASKER, R. (1960). Utilization of organic carbon by a marine crustacean: analysis with carbon-14. *Science, N.Y.*, **131**, 1098-1110.
- LASKER, R. (1964). Moulting frequency of a deep-sea crustacean, *Euphausia pacifica*. *Nature, Lond.*, **203**, 96.
- LASKER, R. (1966). Feeding, growth, respiration and carbon utilization of a euphausiid crustacean. *J. Fish. Res. Bd Can.*, **23**, 1291-1317.
- LASKER, R. (1974). Induced maturation and spawning of marine fish at the Southwest Fisheries Center La Jolla, California. *Proceedings of the World Mariculture Society*, **5**, 313-318.

- LASKER, R., FEDER, H. M., THEILACKER, G. H. and MAY, R. C. (1970). Feeding, growth and survival of *Engraulis mordax* larvae reared in the laboratory. *Mar. Biol.*, **5**, 345-353.
- LASKER, R. and GIESE, A. C. (1954). Nutrition of the sea urchin *Strongylocentrotus purpuratus*. *Biol. Bull. mar. biol. Lab., Woods Hole*, **106**, 328-340.
- LASKER, R. and THEILACKER, G. H. (1965). Maintenance of euphausiid shrimps in the laboratory. *Limnol. Oceanogr.*, **10**, 287-288.
- LASKER, R. and VLYMEN, L. L. (1969). Experimental sea-water aquarium. *Circ. Fish Wildl. Serv., Wash.*, **334**, 1-14.
- LAUBENFELS, M. W. DE (1928a). Interspecific grafting, using sponge cells. *J. Elisha Mitchell scient. Soc.*, **44**, 82-86.
- LAUBENFELS, M. W. DE (1928b). Experiments concerning cellular behavior and physiology of sponges. *Yb. Carnegie Instn Wash.*, **27**, 276-278.
- LAUCKNER, G. (in press). In O. Kinne (Ed.), *Diseases of Marine Animals*. Wiley, London.
- LAUER, B. H. and BAKER, B. E. (1969). Whale milk. I. Fin whale (*Balaenoptera physalus*) and beluga whale (*Delphinapterus leucas*) milk: gross composition and fatty acid constitution. *Can. J. Zool.*, **47**, 95-97.
- LAURENCE, G. C. (1974). Growth and survival of haddock (*Melanogrammus aeglefinus*) larvae in relation to planktonic prey concentration. *J. Fish. Res. Bd Can.*, **31**, 1415-1419.
- LAW, D. K., SINNHUBER, R. O., YU, T. C., HUBLON, W. F. and MCKEE, T. B. (1961). *Res. Briefs Fish Commn Ore.* (Quoted in FRIEDMAN & SHIRKO, 1972.)
- LAWRENCE, J. M. (1975). On the relationships between marine plants and sea urchins. *Oceanogr. mar. Biol.*, **13**, 213-286.
- LAWS, R. M. (1956a). The elephant seal (*Mirounga leonina* LINN.). II: General, social and reproductive behaviour. *Scient. Rep. Falkld Isl. Depend. Surv.*, **13**, 1-88.
- LAWS, R. M. (1956b). The elephant seal (*Mirounga leonina* LINN.). III: The physiology of reproduction. *Scient. Rep. Falkld Isl. Depend. Surv.*, **15**, 1-66.
- LAWS, R. M. (1958). Growth rates and ages of crabeater seals, *Lobodon carcinophagus*, JACQUINOT and PUCHERAN. *Proc. zool. Soc. Lond.*, **130**, 275-288.
- LAZZARETTO-COLOMBERA, I. and POLO, G. (1969). Polimorfismo e superiorità degli eterozigoti nel copepode harpacticoido *Tisbe clodiensis*. *Atti Ist. veneto Sci.*, **127**, 383-391.
- LEBOUR, M. V. (1916). Stages in the life history of *Calanus finmarchicus* (GUNNERUS), experimentally reared by Mr. L. R. Crawshaw in the Plymouth laboratory. *J. mar. biol. Ass. U.K.*, **11**, 1-17.
- LEBOUR, M. V. (1925). Young anglers in captivity and some of their enemies. A study in a plunger jar. *J. mar. biol. Ass. U.K.*, **13**, 721-734.
- LEBOUR, M. V. (1927). Studies of the Plymouth Brachyura. The rearing of crabs in captivity, with a description of the larval stages of *Inachus dorsettensis*, *Macropodia longirostris* and *Maia squinado*. *J. mar. biol. Ass. U.K.*, **14**, 795-821.
- LEBOUR, M. V. (1928a). Studies of the Plymouth Brachyura. The larval stages of *Ebalia* and *Pinnotheres*. *J. mar. biol. Ass. U.K.*, **15**, 109-123.
- LEBOUR, M. V. (1928b). The larval stages of the Plymouth Brachyura. *Proc. zool. Soc. London*, **1928**, 473-560.
- LEBOUR, M. V. (1931). The larval stages of *Nassarius reticulatus* and *Nassarius incrassatus*. *J. mar. biol. Ass. U.K.*, **17**, 797-807.
- LEDEBUR-VILLIGER, M. VON (1975). Cytology of parthenogenetically activated sea urchin eggs. In G. Czihak (Ed.), *The Sea Urchin Embryo*. Springer-Verlag, Berlin. pp. 170-176.
- LEE, C. C. and FENCHEL, T. (1972). Studies on ciliates associated with sea ice from Antarctica. II. Temperature responses and tolerances in ciliates from Antarctic, temperate and tropical habitats. *Arch. Protistenk.*, **114**, 237-244.
- LEE, D. J. and SINNHUBER, R. O. (1972). Lipid requirements. In J. E. Halver (Ed.), *Fish Nutrition*. Academic Press, New York. pp. 145-180.
- LEE, H. (1878). *The White Whale*, Burt & Co., London.
- LEE, J. J. (1967). A new approach to nutrition, physiology, and mineral cycling of Foraminifera. *United States Atomic Energy Commission*, NYO **3396-10**.
- LEE, J. J. (1968). A new approach of nutrition, physiology, and mineral cycling of Foraminifera. *United States Atomic Energy Commission*, NYO **3396-14**.

- LEE, J. J., FREUDENTHAL, H. D., MULLER, W. A., KOSOY, V., PIERCE, S. and GROSSMAN, R. (1963). Growth and physiology of Foraminifera in the laboratory. Part 3. Initial studies of *Rosalina floridana* (CUSHMAN). *Micropaleontology*, **9**, 449-466.
- LEE, J. J., McENERY, M., PIERCE, S., FREUDENTHAL, H. D. and MULLER, W. A. (1966). Tracer experiments in feeding littoral foraminifera. *J. Protozool.*, **13**, 659-670.
- LEE, J. J., McENERY, M. and RUBIN, H. (1969). Quantitative studies on the growth of *Allogromia laticollaris*. *J. Protozool.*, **16**, 377-395.
- LEE, J. J., McLAUGHLIN, J. J. A. and RAYNOR, J. (1959). Preliminary studies on the growth of Foraminifera in the laboratory. *J. Protozool.*, **6** (Suppl.), 12.
- LEE, J. J. and MULLER, W. A. (1975). Culture of salt marsh micro-organisms and micrometazoa. In W. L. Smith and H. M. Chanly (Eds), *Culture of Marine Invertebrate Animals*. Plenum Press, New York. pp. 87-107.
- LEE, J. J. and PIERCE, S. (1963). Growth and physiology of Foraminifera in the laboratory. Part 4. Monoxenic culture of an Allogromiid with notes on its morphology. *J. Protozool.*, **10**, 404-411.
- LEE, J. J., PIERCE, S., FREUDENTHAL, H. D., TENTCHOFF, M. and MULLER, W. A. (1962). Studies on in vitro growth of foraminifera. III. *J. Protozool.*, **9** (Suppl.), 16-17.
- LEE, J. J., PIERCE, S., TENTCHOFF, M. and McLAUGHLIN, J. J. A. (1961a). Growth and physiology of Foraminifera in the laboratory. Part 1. Collection and maintenance. *Micropaleontology*, **7**, 461-466.
- LEE, J. J., PIERCE, S., TENTCHOFF, M. and McLAUGHLIN, J. J. A. (1961b). Preliminary studies on the in vitro growth of Foraminifera. III. *First Int. Congr. Protozool.*, **1961**, 80-81.
- LEE, J. J., TIETJEN, J. H. and MASTROPAOLO, C. A. (1971). Axenic culture of the marine hymenostome ciliate *Uronema marinum* in chemically defined medium. *J. Protozool.*, **18** (Suppl.), 10.
- LEE, J. J., TIETJEN, J. H., STONE, R. J., MULLER, W. A., RULLMAN, J. and McENERY, M. (1970). The cultivation and physiological ecology of members of salt marsh epiphytic communities. *Helgoländer wiss. Meeresunters.*, **20**, 136-156.
- LEE, J. J. and ZUCKER, W. (1969). Algal flagellate symbiosis in the foraminifer *Archaias*. *J. Protozool.*, **16**, 71-81.
- LEHMANN, F. E. (1948). Zur Entwicklungsphysiologie des Polplasmas des Eies von *Tubifex*. *Revue suisse Zool.*, **55**, 1-43.
- LEICK, V. and PLESNER, P. (1968). Formation of ribosomes in *Tetrahymena pyriformis*. *Biochim. biophys. Acta*, **169**, 398-415.
- LEIGHTON, D. L. (1966). Studies of food preference in algivorous invertebrates of southern California kelp beds. *Pacif. Sci.*, **20**, 104-113.
- LEIGHTON, D. L. (1972). Laboratory observations on the early growth of the abalone, *Haliotis sorenseni*, and the effect of temperature on larval development and settling success. *Fish. Bull. U.S.*, **70**, 373-381.
- LENDENFELD, R. VON (1889). Experimentelle Untersuchungen über die Physiologie der Spongien. *Z. wiss. Zool.*, **48**, 406-700.
- LENOFF, H. M. (1971). Principles of coelenterate culture methods. In H. M. Lenhoff, L. Muscatine and L. V. Davis (Eds), *Experimental Coelenterate Biology*. University of Hawaii Press, Honolulu. pp. 9-15.
- LENOFF, H. M. and BROWN, R. D. (1970). Mass culture of hydra: an improved method and its application to other aquatic invertebrates. *Lab. Anim.*, **4**, 139-154.
- LENOFF, H. M., MUSCATINE, L. and DAVIS, L. V. (Eds) (1971). *Experimental Coelenterate Biology*, University of Hawaii Press, Honolulu.
- LEONG, R. (1971). Induced spawning of the northern anchovy *Engraulis mordax* GIRARD. *Fish. Bull. U.S.*, **69**, 357-360.
- LEOSCHKE, W. L. and ELVEHJEM, C. A. (1959). The thiamine requirement of the mink for growth and fur development. *J. Nutr.*, **69**, 211-213.
- LESHCHEVA, T. S. (1968). Formation of defense reflexes in larvae of the roach *Rutilus rutilus* (L.) through imitation. *Vop. Ikhtiol.*, **8**, 1052-1056.
- LESHCHEVA, T. S. (1970). Formation of a defense reflex in young fish. (Quoted in RADAČOV, 1972.)

- LESH-LAURIE, G. E. (1972). *Cordylophora* morphogenesis: precocious sporosac development in non-sessile colonies. *J. mar. biol. Ass. U.K.*, **52**, 191-201.
- LESLIE, G. (1971). Observations on the grey seal *Halichoerus grypus*. *Int. Zoo Yb.*, **11**, 203-204.
- LEWIS, A. G. (1967). An enrichment solution for culturing the early developmental stages of the planktonic marine copepod *Euchaeta japonica* MARUKAWA. *Limnol. Oceanogr.*, **12**, 147-148.
- LEWIS, C. A. (1975). Some observations on factors affecting embryonic and larval growth of *Pollicipes polymerus* (Cirripedia: Lepadomorpha) *in vitro*. *Mar. Biol.*, **32**, 127-139.
- LEWIS, D. B. and WHITNEY, P. J. (1968). Cellulase in *Nereis virens*. *Nature, Lond.*, **220**, 603-604.
- LEWIS, F. (1929). Report of the chief inspector of fisheries and game on an investigation into the feeding habits, etc., of seals in Victorian waters. *Rep. to Parliament No. 23 (Is)*, **11391**, 1-17. (Melbourne, Victoria, Government Printer.)
- LEWIS, J. B. (1961). Preliminary experiments on the rearing of the fresh water shrimp *Macrobrachium carcinus* (L.). *Proc. Gulf. Carrib. Fish. Inst.*, **14**, 199-201.
- LEWIS, J. B. and WARD, J. (1965). Development stages of the palaemonid shrimp *Macrobrachium carcinus* (LINNAEUS, 1758). *Crustaceana*, **9**, 137-148.
- LIAO, I. C., LU, Y. J., HUANG, T. L. and LIN, M. C. (1972). Experiments on induced breeding of the grey mullet, *Mugil cephalus* LINNAEUS. In T. V. R. Pillay (Ed.), *Coastal Aquaculture in the Indo-Pacific Region*. Fishing News (Books) Ltd., Surrey. pp. 213-243.
- LIEBERKIND, I. (1920). On a star-fish (*Asterias grenlandica*) which hatches its young in its stomach. *Vidensk. Meddr dansk naturh. Foren.* (Ser. 8), **72**, 121-126.
- LIEBERKIND, I. (1926). *Ctenodiscus australis* LÜTKEN. A brood-protecting asteroid. *Vidensk. Meddr dansk naturh. Foren.* (Ser. 8), **82**, 183-196.
- LIEBERKÜHN, N. (1859). Neue Beiträge zur Anatomie der Spongien. *Arch. Anat. Physiol.*, **1859**, 353-382.
- LILLELUND, K. (1967). Experimentelle Untersuchungen über den Einfluß carnivorer Cyclopiden auf die Sterblichkeit der Fischbrut. *Z. Fisch.*, **15**, 29-43.
- LILLELUND, K. and LASKER, R. (1971). Laboratory studies of predation by marine copepods on fish larvae. *Fish. Bull. U.S.*, **69**, 655-667.
- LILLIE, F. R. (1912). The production of sperm iso-agglutinins by ova. *Science, N.Y.*, **36**, 527-530.
- LILLIE, F. R. (1919). *Problems of Fertilization*, University of Chicago Press, Chicago.
- LILLY, D. M. (1953). The nutrition of carnivorous Protozoa. *Ann. N.Y. Acad. Sci.*, **56**, 910-920.
- LILLY, D. M. (1967). Growth factors in Protozoa. In M. Florkin and B. T. Scheer (Eds), *Chemical Zoology*, Vol. I. Academic Press, New York. pp. 275-307.
- LILLY, D. M., HERBST, B. A. and STILLWELL, R. H. (1961). A reciprocal stimulatory effect on growth in two species of ciliates. *Am. Zool.*, **1**, 459.
- LILLY, D. M. and KLOSEK, R. C. (1961). A protein factor in the nutrition of *Paramecium caudatum*. *J. gen. Microbiol.*, **24**, 327-334.
- LILLY, D. M., STERBENZ, F. J. and TARANTOLA, V. (1953). Growth promotion in carnivorous Protozoa by substituted purines. *Proc. Soc. exp. Biol. Med.*, **83**, 434-438.
- LILLY, D. M. and STILLWELL, R. H. (1965). Probiotics: growth-promoting factors produced by microorganisms. *Science, N.Y.*, **147**, 747-748.
- LILLY, J. C. (1962). *Man and Dolphin*, Gollancz, London.
- LILLY, J. C. (1966). Discussion remarks to 'Round Table: Practical Problems'. In K. S. Norris (Ed.), *Whales, Dolphins, and Porpoises*. University of California Press, Berkeley. pp. 649-673.
- LIN, S. Y. (1959). *Pond Culture of Warm-Water Fishes*, UNESCO Conference, Warm Springs, Georgia.
- LINDBERG, R. G. (1955). Growth, population dynamics and field behaviour in the spiny lobster, *Panulirus interruptus* (RANDALL). *Univ. Calif. Publ. Zool.*, **59**, 157-248.
- LINDNER, M. J. and ANDERSON, W. W. (1956). Growth, migrations, spawning and size distribution of shrimp, *Penaeus setiferus*. *Fishery Bull. Fish Wildl. Serv. U.S.*, **106**, 555-645.
- LINDNER, M. J. and COOK, H. L. (1970). Synopsis of biological data on the white shrimp *Penaeus setiferus* (LINNAEUS) 1767. *F.A.O. Fish. Rep.*, **57**, 1439-1469.

- LINDROTH, A. (1938). Studien über die respiratorischen Mechanismen von *Nereis virens* Sars. *Zool. Bidr. Uppsala*, **17**, 367-497.
- LINDSEY, A. A. (1937). Weddell seal in the Bay of Whales, Antarctica. *J. Mammal.*, **18**, 127-144.
- LINDSTEDT, K. J. (1971). Valine activation of feeding in the sea anemone *Bolocerooides*. In H. W. Lenhoff, L. Muscatine and L. V. Davis (Eds), *Experimental Coelenterate Biology*. University of Hawaii Press, Honolulu. pp. 92-99.
- LINFORD, M. B. (1937). The feeding of some hollow-stylet nematodes. *Proc. helminth. Soc. Wash., D.C.*, **4**, 41-46.
- LING, J. K. (1970). Pelage and molting in wild mammals with special reference to aquatic forms. *Q. Rev. Biol.*, **45**, 16-54.
- LING, J. K. (1974). The integument of marine mammals. In R. J. Harrison (Ed.), *Functional Anatomy of Marine Mammals*, Vol. 2. Academic Press, London. pp. 1-44.
- LING, J. K. and BUTTON, C. E. (1975). The skin and pelage of grey seal pups (*Halichoerus grypus* FABRICIUS): with a comparative study of foetal neo-natal moulting in the Pinnipedia. *Rapp. P.-v. Réun. Cons. int. Mer*, **169**, 112-132.
- LING, J. K. and THOMAS, C. D. B. (1967). The skin and hair of the Southern elephant seal, *Mirounga leonina* (L.). II: Pre-natal and early post-natal development and moulting. *Aust. J. Zool.*, **15**, 349-365.
- LING, S. W. (1962). Studies on the rearing of larvae and juveniles and culturing of adults of *Macrobrachium rosenbergii* (DE MAN). *Curr. Aff. Bull. Indo-Pacif. Fish. Coun.*, **35**, 1-11.
- LING, S. W. (1967). Feeds and feeding of warm-water fishes in ponds in Asia and the Far East. *F.A.O. Fish. Rep.*, **44**, 291-309.
- LING, S. W. (1969a). The general biology and development of *Macrobrachium rosenbergii* (DE MAN). *F.A.O. Fish. Rep.*, **57**, 589-606.
- LING, S. W. (1969b). Methods of rearing and culturing *Macrobrachium rosenbergii* (DE MAN). *F.A.O. Fish. Rep.*, **57**, 607-619.
- LING, S. W. and MERICAN, A. B. O. (1961). Notes on the life and habits of the adults and larval stages of *Macrobrachium rosenbergii* (DE MAN). *Proc. Indo-Pacif. Fish. Coun.*, **9**, 55-61.
- LISTON, J., STANSBY, M. E. and OLCOTT, H. S. (1963). Bacteriological and chemical basis for deteriorative changes. In M. E. Stansby (Ed.), *Industrial Fishery Technology*. Reinhold Publishing Corp., New York. pp. 350-361.
- LITTLE, E. E. (1975). Chemical communication in maternal behaviour of crayfish. *Nature, Lond.*, **255**, 400-401.
- LITTLE, G. (1969). The larval development of the shrimp, *Palaemon macrodactylus* RATHBUN, reared in the laboratory, and the effect of eyestalk extirpation on development. *Crustaceana*, **17**, 69-87.
- LITTLEFORD, R. A. (1939). The life cycle of *Dactylometra quinquecirrha*, L. AGASSIZ in the Chesapeake Bay. *Biol. Bull. mar. biol. Lab., Woods Hole*, **77**, 368-381.
- LOCK, A. R. and McLAREN, I. A. (1970). The effect of varying and constant temperatures on the size of a marine copepod. *Limnol. Oceanogr.*, **15**, 638-640.
- LOISEL, G. (1898). Contribution à l'histo-physiologie des éponges. *J. Anat. Physiol., Lond.*, **34**, 187-234.
- LONG, D. C. DE, HALVER, J. E. and MERTZ, E. T. (1958). Nutrition of salmonoid fishes. VI. Protein requirements of Chinook salmon at two water temperatures. *J. Nutr.*, **65**, 589-599.
- LONGWELL, A. C. (1968). Oyster genetics: Research and commercial applications. In *Proceedings of the Conference on Shellfish Culture*. Suffolk County Community College, Long Island, N.Y. pp. 91-103.
- LONGWELL, A. C. and STILES, S. S. (1970). The genetic system and breeding potential of the commercial American oyster. *Endeavour*, **29**, 94-99.
- LONGWELL, A. C. and STILES, S. S. (1972). Cross incompatibility and inbreeding in the American oyster, *Crassostrea virginica*. *Proc. natn Shellfish. Ass.*, **62**, 4.
- LONGWELL, A. C. and STILES, S. S. (1973a). Oyster genetics and the probable future role of genetics in aquaculture. *Malacological Rev.*, **6**, 151-177.
- LONGWELL, A. C. and STILES, S. S. (1973b). Gamete cross incompatibility and inbreeding in the commercial American oyster, *Crassostrea virginica* GMELIN. *Cytologia*, **38**, 521-533.

- LOOMIS, W. F. (1953). The cultivation of *Hydra* under controlled conditions. *Science, N. Y.*, **117**, 565-566.
- LOOMIS, W. F. (1954). Environmental factors controlling growth in hydra. *J. exp. Zool.*, **126**, 223-234.
- LOOMIS, W. F. and LENHOFF, H. M. (1956). Growth and sexual differentiation of hydra in mass culture. *J. exp. Zool.*, **132**, 555-574.
- LOOSANOFF, V. L. (1937a). Seasonal gonadal changes of adult clams, *Venus mercenaria* (L.). *Biol. Bull. mar. biol. Lab., Woods Hole*, **72**, 406-416.
- LOOSANOFF, V. L. (1937b). Laboratory culture of *Enchytraeus*. In J. G. Needham (Ed.), *Culture Methods for Invertebrate Animals*. Comstock Publishing Co. p. 113.
- LOOSANOFF, V. L. (1942). Seasonal gonadal changes in the adult oysters, *Ostrea virginica*, of Long Island Sound. *Biol. Bull. mar. biol. Lab., Woods Hole*, **82**, 195-206.
- LOOSANOFF, V. L. (1954). New advances in the study of bivalve larvae. *Am. Scient.*, **42**, 607-624.
- LOOSANOFF, V. L. (1971). Development of shellfish culture techniques. In *Proceedings of the Conference on Artificial Propagation of Commercially Valuable Shellfish—Oysters*. College of Marine Studies, University of Delaware, Newark.
- LOOSANOFF, V. L. and DAVIS, H. C. (1950). Conditioning *V. mercenaria* for spawning in winter and breeding its larvae in the laboratory. *Biol. Bull. mar. biol. Lab., Woods Hole*, **98**, 60-65.
- LOOSANOFF, V. L. and DAVIS, H. C. (1952). Delaying spawning of lamellibranchs by low temperature. *J. mar. Res.*, **10**, 197-202.
- LOOSANOFF, V. L. and DAVIS, H. C. (1963a). Rearing of bivalve mollusks. In F. S. Russel (Ed.), *Advances in Marine Biology*, Vol. 1. Academic Press, New York. pp. 1-136.
- LOOSANOFF, V. L. and DAVIS, H. C. (1963b). Shellfish hatcheries and their future. *Comml. Fish. Rev.*, **25**, 1-11.
- LOOSANOFF, V. L., DAVIS, H. C. and CHANLEY, P. E. (1953a). Behavior of clam larvae in different concentrations of food organisms. *Anat. Rec.*, **117**, 586-587.
- LOOSANOFF, V. L., DAVIS, H. C. and CHANLEY, P. E. (1953b). Lack of relation between age of oysters or clams and quality of their spawn. *Oyster Inst. North America, Trade Rep.*, **133**, 1-2.
- LOOSANOFF, V. L., DAVIS, H. C. and CHANLEY, P. E. (1955). Food requirements of some bivalve larvae. *Proc. natn. Shellfish. Ass.*, **45**, 66-83.
- LOOSANOFF, V. L., MILLER, W. S. and SMITH, P. B. (1951). Growth and setting of larvae of *Venus mercenaria* in relation to temperature. *J. mar. Res.*, **10**, 59-81.
- LOOSANOFF, V. L. and SHIPLEY, D. D. (1947). On ability of starfish *Asterias forbesi*, to detect food. *Anat. Rec.*, **99**, 643-644.
- LUCAS, C. E. (1947). The ecological effect of external metabolites. *Biol. Rev.*, **22**, 270-295.
- LUCAS, F. A. (1899). The food of the Northern fur seals. In D. S. Jordan (Ed.), *The Fur Seals and Fur Seal Islands of the North Pacific Ocean*. U.S. Treas. Dep. Doc., **2017** (3), 59-68.
- LUDWIG, H. (1897). Ein neuer Fall von Brutpflege bei Holothuriern. *Zool. Anz.*, **20**, 217-219.
- LUDWIG, H. (1898). Brutpflege und Entwicklung von *Phyllophorus urna* GRUBE. *Zool. Anz.*, **21**, 95-101.
- LUDWIG, H. (1900). Arktische und subarktische Holothurien. *Fauna arct., Jena*, **1**, 133-178.
- LUDWIG, H. (1903). Seesterne. *Résultats. Voyage S. Y. Belgica*, **1903**, 1-72.
- LUDWIG, W. and LUDWIG, H. W. (1954). Untersuchungen zur kompensatorischen Regeneration an *Hydroides norvegica*. *Wilhelm Roux Arch. EntwMech. Org.*, **147**, 259-287.
- LUEKEN, W. W. (1973). A marine *Euplotes* (Ciliophora, Hypotrichida) with reduced number of prezygotic micronuclear divisions. *J. Protozool.*, **20**, 143-145.
- LUMARE, F., BLUNDO, C. M. and VILLANI, P. (1971). Reproduction and intensive breeding of *Penaeus kerathurus* (FORSKÅL 1775) from egg to post-larval stage. *Boll. Pesca Piscic. Idrobiol.*, **26**, 209-236.
- LUMARE, F. and VILLANI, P. (1974). Intensive reproduction of *Penaeus kerathurus* (FORSKÅL, 1775) under controlled conditions and culture in brackish-water. *Rapp. P.-v. Réun. Comm. int. Explor. scient. Mer. Méditerr., Monaco*, **22**, 39.
- LUND, D. S. (1973). Feeding studies with Pacific oyster larvae. *Proc. natn. Shellfish. Ass.*, **63**, 8.
- LUNTZ, A. (1926). Untersuchungen über den Generationswechsel der Rotatorien. I. Die Bedingungen des Generationswechsels. *Biol. Zbl.*, **46**, 233-278.

- LUNTZ, A. (1929). Untersuchungen über den Generationswechsel der Rädertiere. II. Der zyklische Generationswechsel von *Brachionus bakeri*. *Biol. Zbl.*, **49**, 193-211.
- LUNZ, G. R. (1958). Pond cultivation of shrimp in South Carolina. *Proc. Gulf Caribb. Fish. Inst.*, 10th Ann. Sess., **1958**, 44-48.
- LUNZ, G. R. (1967a). Farming the salt water marshes. In *Proceedings of the Marsh and Estuary Management Symposium*. Louisiana State University, Baton Rouge. pp. 172-177.
- LUNZ, G. R. (1967b). Annual Report 1965-1966. Bears Bluff Laboratories, Wadmalaw Island, South Carolina. *Contr. Bears Bluff Labs*, **44**, 1-11.
- LUNZ, G. R. and BEARDEN, C. M. (1963). Control of predaceous fishes in shrimp farming in South Carolina. *Contr. Bears Bluff Labs*, **36**, 1-9.
- LUTZ, R. A., HIDU, H. and DROBECK, K. G. (1969). Acute temperature increase as a stimulus to setting in the American oyster *Crassostrea virginica* (GMELIN). *Proc. natn. Shellfish. Ass.*, **60**, 68-71.
- LUTZE, G. F., GRABERT, B. and SEIBOLD, E. (1971). Lebendbeobachtungen an Großforaminiferen (*Heterostegina*) aus dem Persischen Golf. 'Meteor' *Forsch. Ergebn.*, **6**, 21-40.
- LWOFF, A. (1923). Sur la nutrition des Infusories. *C.r. hebd. Séanc. Acad. Sci., Paris*, **176**, 928.
- LWOFF, A. (1927). Le cycle du pigment carotinoïde chez *Idya furcata* (BAIRD) (Copépode Harpacticide). *Bull. biol. Fr. Belg.*, **61**, 193-240.
- LYMAN, J. and FLEMING, R. H. (1940). Composition of sea water. *J. mar. Res.*, **3**, 134-146.
- LYNCH, W. F. (1947). The behavior and metamorphosis of the larva of *Bugula neritina* (L.): Experimental modification of the length of the free swimming period and the response of the larva to light and gravity. *Biol. Bull. mar. biol. Lab., Woods Hole*, **92**, 115-150.
- LYTLE, C. F. (1961). Patterns of budding in the fresh water hydroid *Craspedacusta*. In H. M. Lenhoff and W. F. Loomis (Eds), *The Biology of Hydra and of Some Other Coelenterates*. University of Miami Press, Coral Gables, pp. 317-336.
- MAAS, O. (1894). Die Embryonalentwicklung und Metamorphose der Cornacuspongien. *Zool. Jb. (Anat. Ontogenie Tiere)*, **7**, 331-448.
- MAAS, O. (1900). Die Weiterentwicklung der Syconen nach der Metamorphose. *Z. wiss. Zool.*, **64**, 215-240.
- MAAS, O. (1904). Über die Wirkung der Kalkentziehung auf die Entwicklung der Kalkschwämme. *Sitzungsbericht der Gesellschaft für Morphologie und Physiologie. München*, **1904**, 1-18.
- MAAS, O. (1906). Über die Einwirkung karbonatfreier und kalkfreier Salzlösungen auf erwachsene Kalkschwämme und auf Entwicklungsstadien derselben. *Arch. EntwMech. Org.*, **22**, 581-599.
- MAAS, O. (1907). Über die Wirkung des Hungers und der Kalkentziehung bei Kalkschwämmen und anderen kalkausscheidenden Organismen. *Sitzungsbericht der Gesellschaft für Morphologie und Physiologie. München*, **1907**, 1-8.
- MAAS, O. (1910). Über Involutionerscheinungen bei Schwämmen und ihre Bedeutung für die Auffassung des Spongienkörpers. *Festschrift zum 60. Geburtstage Richard Hertwigs*, **3**, 94-130.
- MAAS, O. (1912). Vitalfärbung bei Kalkschwämmen im normalen und im Involutionzustand. *Zool. Jb.*, **15** (Suppl.), 253-268.
- MACANDREW, R. and BARRETT, L. (1857). List of the Echinodermata dredged between Drontheim and the North Cape. *Ann. Mag. nat. Hist. (Ser. 2)*, **20**, 43-47.
- MCCARTHUR, R. H. and PIANKA, E. R. (1966). On optimal use of a patchy environment. *Am. Nat.*, **100**, 603-609.
- MCBRIDE, A. F. and HEBB, D. O. (1948). Behavior of the captive bottle-nosed dolphin *Tursiops truncatus*. *J. comp. physiol. Psychol.*, **41**, 111-123.
- MCBRIDE, E. W. (1892). The development of the genital organs, ovoid gland, axial and aboral sinuses in *Amphiura squamata*; together with some remarks on Ludwig's haemal system in this ophiuroid. *Q. Jl. microsc. Sci.*, **34**, 129-153.
- MCBRIDE, E. W. and SIMPSON, J. C. (1908). Echinoderm larvae. *National Antarctic Expedition, Nat. Hist.*, **4**, 1-9.
- MCCLARY, A. (1959). The effect of temperature on growth and reproduction in *Craspedacusta sowerbyi*. *Ecology*, **40**, 158-162.
- MCCLOSKEY, L. R. (1970). The dynamics of the community associated with a marine scleractinian coral. *Int. Revue ges. Hydrobiol.*, **55**, 13-81.

- MACDONALD, R. (1927). Food and habits of *Meganyctiphanes norvegica*. *J. mar. biol. Ass. U.K.*, **14**, 753-784.
- MACGINITIE, G. E. (1939). The method of feeding of *Chaetopterus*. *Biol. Bull. mar. biol. Lab., Woods Hole*, **77**, 115-118.
- MACGINITIE, G. E. and MACGINITIE, N. (1949). *Natural History of Marine Animals*, McGraw-Hill, New York.
- MCGINN, M. P. (1971). Axenic cultivation of *Noctiluca scintillans*. Ph.D. Thesis, Fordham University, New York, N.Y.
- MCGINN, M. P. and GOLD, K. (1969). Axenic cultivation of *Noctiluca scintillans*. *J. Protozool.*, **16** (Suppl.), 13.
- MCGINNES, S. M. (1968). Biotelemetry in pinnipeds. In R. J. Harrison, R. C. Hubbard, R. S. Peterson, C. E. Rice and R. J. Schusterman (Eds), *The Behavior and Physiology of Pinnipeds*. Appleton-Century-Crofts, New York. pp. 54-67.
- MCGINNES, S. M. (1975). Peripheral heat exchange in phocids. *Rapp. P.-v. Réun. Cons. int. Explor. Mer*, **169**, 481-486.
- MCGINNES, S. M., CRYER, E. F. and HUBBARD, R. C. (1970). Peripheral heat dissipation in pinnipeds. In *Proceedings of the 7th Annual Conference on Biological Sonar and Diving Mammals*. Stanford Research Institute, Menlo Park, California. pp. 159-168.
- MCINERNEY, J. E. and EVANS, D. O. (1970). Action spectrum of the photoperiod mechanism controlling sexual maturation in the three-spine stickleback, *Gasterosteus aculeatus*. *J. Fish. Res. Bd Can.*, **27**, 749-763.
- MCINTOSH, W. C. (1910). *A Monograph of the British Annelids*, Vol. 2, Pt 2, Ray Society, London.
- MACKENZIE, C. L., JR. (1970a). Causes of oyster spat mortality, conditions of oyster setting beds, and recommendations for oyster bed management. *Proc. natn. Shellfish. Ass.*, **60**, 59-67.
- MACKENZIE, C. L., JR. (1970b). Control of oyster drills, *Eupleura caudata* and *Urosalpinx cinerea*, with the chemical Polystream. *Fishery Bull. Fish Wildl. Serv. U.S.*, **68**, 285-297.
- MACKENZIE, C. L., JR., LOOSANOFF, V. L. and GNEWUCH, W. T. (1961). Use of chemically-treated cultch for increased production of seed oysters. *Bull. Bur. Commer. Fish. Biol. Lab., Milford, Conn.*, **5**, 25, 1-9.
- MACKIE, G. O. (1966). Growth of the hydroid *Tubularia* in culture. In W. J. Rees (Ed.), *The Cnidaria and Their Evolution*. Academic Press, New York. pp. 397-412.
- MACKINNON, D. L. and HAWES, R. S. J. (1961). *An Introduction to the Study of Protozoa*, Oxford University Press, London.
- MCLAREN, I. A. (1958a). Some aspects of growth and reproduction of the Bearded seal (*Erigonathus barbatus* ERXLEBEN). *J. Fish. Res. Bd Can.*, **15**, 219-227.
- MCLAREN, I. A. (1958b). The biology of the Ringed seal, *Phoca hispida* (SCHREBER) in the eastern Canadian Arctic. *Bull. Fish. Res. Bd Can.*, **118**, 1-97.
- MCLAREN, I. A. (1963). Effects of temperature on growth of zooplankton, and the adaptive value of vertical migration. *J. Fish. Res. Bd Can.*, **20**, 685-727.
- MCLAREN, I. A. (1966). Predicting development rate of copepod eggs. *Biol. Bull. mar. biol. Lab., Woods Hole*, **131**, 457-469.
- MCLAREN, I. A., CORKETT, C. J. and ZILLIOUX, E. J. (1969). Temperature adaptation of copepod eggs from the Arctic to the tropics. *Biol. Bull. mar. biol. Lab., Woods Hole*, **137**, 486-493.
- MCMYNN, R. G. and HOAR, W. S. (1953). Effects of salinity on the development of the Pacific herring. *Can. J. Zool.*, **31**, 417-432.
- MACNAE, W. and KALK, M. (1962). The fauna and flora of sand flats at Inhaca Island, Mozambique. *J. Anim. Ecol.*, **31**, 93-128.
- MCNALLY, J. and LYNCH, D. D. (1954). Notes on the food of Victorian seals, Melbourne. *Victoria Fish. Game Fauna Rep.*, **1**, 1-16.
- MCNEIL, W. J. (Ed.) (1970). *Marine Aquiculture*, Oregon State University Press, Corvallis.
- MADSEN, F. J. (1956). Echinoidea, Asteroidea, and Ophiuroidea from depths exceeding 6000 meters. *Galathea Rep.*, **2**, 23-32.

- MADSEN, F. J. (1961). The Porcellanasteridae. A monographic revision of an abyssal group of sea-stars. *Galathea Rep.*, **4**, 33-174.
- MAGNUS, D. B. E. (1963a). Über das 'Abweiden' der Flutwasseroberfläche durch den Schlangensterne *Ophiocoma scolopendrina* (LAMARCK). *Zool. Anz.*, **26** (Suppl.), 471-481.
- MAGNUS, D. B. E. (1963b). Der Federstern *Heterometra savignyi* im Roten Meer. *Natur Mus., Frankf.*, **93**, 355-368.
- MAGNUS, D. B. E. (1964). Gezeitenströmung und Nahrungsfiltration bei Ophiuren und Crinoiden. *Helgoländer wiss. Meeresunters.*, **10**, 104-117.
- MALEK, S. R. A. and BAWAB, F. M. (1974). The formation of the spermatophore in *Penaeus kerathurus* (FORSKÅL, 1775) (Decapoda, Penaeidae). I. The initial formation of a sperm mass. *Crustaceana*, **26**, 273-285.
- MALORNY, G. and RIETBROCK, N. (1965). Pharmacologically effective substances occurring in fish. In R. Kreuzer (Ed.), *The Technology of Fish Utilization*. Fishing News (Books) Ltd., London. pp. 79-83.
- MALSSEN, H. F. VON (1906). Geschlechtsbestimmende Einflüsse und Eibildung des *Dinophilus apatris*. *Arch. mikrosk. Anat.*, **69**, 63-99.
- MAMKAEV, IU. V. and SERAVIN, L. N. (1963). Pitanie beskischechnoi turbellarii *Convoluta convoluta* (ABILDGAARD). *Zool. Zh.*, **47**, 197-205.
- MANACOP, P. R. (1937). The artificial fertilization of dangit, *Amphacanthus oramin* (BLOCH & SCHNEIDER). *Philipp. J. Sci.*, **62**, 229-237.
- MANN, H. (1967a). Der Einsatz von Antibiotika in der Fischzucht. *Fette, Seifen, Anstr.-Mittel*, **69**, 945-949.
- MANN, H. (1967b). Weitere Versuche zur Frage der Antibiotikarückstände im Fischfleisch. *Fischwirt*, **17**, 13-14.
- MANN, H. (1968). Fütterungsversuche an Forellen bei Zusatz von Zinkbacitracin. *Fischwirt*, **18**, 116-120.
- MANN, H. (1973). Neben- und Nachwirkungen von Medizinalfutter bei Fischen. *Vortrag anlässlich der Tagung der 'Ehemaligen' vom 8.-10.1.73 an der Bayerischen Landesanstalt für Fischerei*. Starnberg.
- MANSFIELD, A. W. (1958a). The biology of the Atlantic walrus, *Odobenus rosmarus* (LINNAEUS) in the eastern Canadian Arctic. *Rep. Fish. Res. Bd Can.* (MS Rep. Ser. Biol.), **653**, 1-146.
- MANSFIELD, A. W. (1958b). The breeding behavior and reproductive cycle of the Weddell seal (*Leptonychotes weddelli* LESSON). *Rep. Falkld Isl.*, **18**, 1-41.
- MANTON, V. J. A. (1974). Some experiences with gas chlorination. *Aquatic Mammals*, **2**, 1-7.
- MANTON, V. J. A. (in press). Relation of salinity to chlorination in dolphin pools. (To be published in *Marine Mammals*.)
- MAPSTONE, G. M. (1970). Feeding activities of veligers of *Nassarius reticulatus* and *Crepidula fornicata* and the use of artificial foods in maintaining cultures of these larvae. *Helgoländer wiss. Meeresunters.*, **20**, 565-575.
- MARCUS, E. (1926). Beobachtungen und Versuche an lebenden Meeresbryozoen. *Zool. Jb. (System. Ökol. Geogr. Tiere)*, **52**, 1-102.
- MARISCAL, R. N. (1971). The chemical control of the feeding behavior in some Hawaiian corals. In H. M. Lenhoff, L. Muscatine and L. V. Davis (Eds), *Experimental Coelenterate Biology*. University of Hawaii Press, Honolulu. pp. 100-118.
- MARR, J. C. (1956). The 'critical period' in the early life history of marine fishes. *J. Cons. perm. int. Explor. Mer*, **21**, 160-170.
- MARSHALL, S. M. (1932). Notes on the oxygen production in coral planulae. *Scient. Rep. Gt. Barrier Reef Exped.*, **1**, 253-258.
- MARSHALL, S. M. and ORR, A. P. (1952). On the biology of *Calanus finmarchicus*. VII. Factors affecting egg production. *J. mar. biol. Ass. U.K.*, **30**, 527-547.
- MARSHALL, S. M. and ORR, A. P. (1955). *The Biology of a Marine Copepod Calanus finmarchicus* (Gunnerus), Oliver & Boyd, Edinburgh.
- MARSHALL, S. M. and STEPHENSON, T. A. (1933). The breeding of reef animals. Part I. The corals. *Scient. Rep. Gt. Barrier Reef Exped.*, **3**, 219-245.
- MARTEN, G. G. (1973). An optimization equation for predation. *Ecology*, **54**, 92-101.

- MARTIN, J. H., ELLIOT, P. D., ANDERLINI, V. C., GIRVIN, D., JACOBS, S. A., RISEBROUGH, R. W., DELONG, R. L. and GILMARTIN, W. G. (1976). Mercury-selenium-bromine imbalance in premature parturient California sea lions. *Mar. Biol.*, **35**, 91-104.
- MASON, J. (1972). The cultivation of the European mussel *Mytilus edulis* LINNAEUS. *Oceanogr. mar. Biol., A. Rev.*, **10**, 437-460.
- MAST, E. C. and PACE, D. M. (1938). The effect of substances produced by *Chilomonas paramecium* on the rate of reproduction. *Physiol. Zool.*, **11**, 359-382.
- MATHISEN, O. A., BAADE, R. T. and LOPP, R. J. (1962). Breeding habits, growth and stomach contents of the Steller sea lion in Alaska. *J. Mammal.*, **43**, 469-477.
- MATSUURA, D. T. and WHITTOW, G. C. (1972). Partition of evaporative heat loss in the California sea lion. *Fedn Proc. Fedn Am. Socs exp. Biol.*, **31**, 826.
- MATTHEWS, A. (1916). The development of *Alcyonium digitatum* with some notes on the early colony formation. *Q. Jl microsc. Sci.*, **62**, 43-94.
- MATTHEWS, D. C. (1966). A comparative study of *Craspedacusta sowerbyi* and *Calposoma dactyloptera* life cycles. *Pacif. Sci.*, **20**, 246-259.
- MATTHEWS, L. H. (1929). The natural history of the Elephant seal, with notes on other seals found at South Georgia. 'Discovery' Rep., **1**, 233-256.
- MATTHIESSEN, G. C. (1971). A review of oyster culture and the oyster industry in North America. *Repr. Fla. Dept. Nat. Resour. Mar. Res. Lab.*, August **71**, 1-52.
- MAUPAS, E. (1891). Sur la détermination de la sexualité chez l'*Hydatina senta*. *C.r. hebd. Séanc. Acad. Sci., Paris*, **113**, 388-390.
- MAXWELL, P. D. (1972). Notes on the husbandry, biology, and behavior of two grey seals at the San Francisco Zoological Gardens. In *Proceedings of the 9th Annual Conference on Biological Sonar and Diving Mammals*. Biological Sonar Laboratory, Fremont, California. pp. 37-46.
- MAY, R. C. (1970). Feeding larval marine fishes in the laboratory: a review. *Rep. Calif. coop. oceanic Fish. Invest.*, **14**, 76-83.
- MAY, R. C. (1971). Effects of delayed initial feeding on larvae of the grunion, *Leuresthes tenuis* (AYRES). *Fish. Bull.*, **69**, 411-425.
- MAY, R. C. (1972). An annotated bibliography of attempts to rear the larvae of marine fishes in the laboratory. *Spec. scient. Rep. U.S. Fish Wildl. Serv.*, **632**, 1-24.
- MAY, R. C. (1974). Larval mortality in marine fishes and the critical period concept. In J. H. S. Blaxter (Ed.), *The Early Life History of Fish*. Springer-Verlag, Berlin. pp. 3-19.
- MAY, R. C., POPPER, D. and MCVEY, J. P. (1974). Rearing and larval development of *Siganus canaliculatus* (PARK) (Pisces: Siganidae). *Micronesica*, **10**, 285-298.
- MAYER, M. (1956). *Kultur und Präparation der Protozoen*, Kosmos Verlag Franckh, Stuttgart.
- MAYER, P. (1881). Die Metamorphose von *Palaemonetes varians*. *Mitt. zool. Stn Neapel*, **2**, 197-221.
- MAYNARD, L. A. and LOOSLI, J. K. (1956). *Animal Nutrition*, McGraw-Hill, New York.
- MEAD, A. D. (1900). The natural history of the starfish (*A. forbesi*). *Bull. U.S. Fish Commn.*, **19**, 203-224.
- MEAD, A. D. (1901). Experiments in lobster culture. *Trans. Am. Fish. Soc.*, **30**, 94-100.
- MEAD, A. D. (1908). A method of lobster culture. *Bull. Bur. Fish., Wash.*, **28**, 219-240.
- MECKLENBURG, T. A. and CHAET, A. B. (1964). Calcium and the shedding substance of *Patiria miniata*. *Am. Zool.*, **4**, 414.
- MEDEM, F. and GRAF, V. (1948). Untersuchungen über die Ei- und Spermwirkstoffe bei marinen Mollusken. *Zool. Jb. (Allg. Zool. Physiol. Tiere)*, **61**, 4-44.
- MEDNIKOV, B. M. (1961). On sex ratio in deep-water Calanoida. *Crustaceana*, **3**, 105-109.
- MEEK, A. (1909-10). Lobster culture. Northumberland Sea Fish. *Ctie. Rept., Sci. Inv.*, **24** pp.
- MEIXNER, R. (1966). Eine Methode zur Aufzucht von *Crangon crangon* (L.) (Crust. Decap. Natantia). *Arch. FischWiss.*, **17**, 1-4.
- MEIXNER, R. (1971). Wachstum und Ertrag von *Mytilus edulis* bei Floßkultur in der Flensburger Förde. *Arch. FischWiss.*, **22**, 41-50.
- MEIXNER, R. (1972). Survival and growth of O-group *Crassostrea gigas* held in enclosures at the North Sea and Baltic Sea coast of Slesvig-Holsten. *Coun. Meet. int. Coun. Explor Sea (C.M.—I.C.E.S.)*, **K:7**, 1-11.

- MEIXNER, R. (1973). Floating culture trials of Pacific oysters *Crassostrea gigas* on the North Sea and Baltic Coast of Germany. *Arch. FischWiss.*, **24**, 177-189.
- MENGE, B. A. (1975). Brood or broadcast? The adaptive significance of different reproductive strategies in the two intertidal sea stars *Leptasterias hexactis* and *Pisaster ochraceus*. *Mar. Biol.*, **31**, 87-100.
- MENON, N. R. (1972). Heat tolerance, growth and regeneration in three North Sea bryozoans exposed to different constant temperatures. *Mar. Biol.*, **15**, 1-11.
- MENON, N. R. (1974). Clearance rates of food suspension and food passage rates as a function of temperature in two North-Sea bryozoans. *Mar. Biol.*, **24**, 65-67.
- MENU-MARQUE, S. A. (1973). The larval development of *Palaemonetes argentinus* (NOBILL, 1901) in the laboratory. *Physis (A), B. Aires*, **32**, 495-496.
- MERCADO, P. (1959). Proyecto para estación rustica dedicado al cultivo de los lanostinos. *Bol. Pisc. rural.*, **9**, 6-9.
- MERGNER, H. (1970). Ergebnisse der Entwicklungsphysiologie bei Spongilliden. *Symp. Zool. Soc. Lond.*, **25**, 365-397.
- MERTZ, E. T. (1972). The protein and amino acid needs. In J. E. Halver (Ed.), *Fish Nutrition*. Academic Press, New York. pp. 105-143.
- MESKE, C. (1973a). Experimentally induced sexual maturity in artificially reared male eels (*Anguilla anguilla*). In J. H. Schröder (Ed.), *Genetics and Mutagenesis of Fish*. Springer-Verlag, Berlin. pp. 161-170.
- MESKE, C. (1973b). Induced spawning and observations of sexual differentiation in eels in warm-water keeping. *EIFAC Workshop on Controlled Reproduction of Cultivated Fishes*. Hamburg.
- MESKE, C. and CELLARIUS, O. (1972). Laboraufzucht von Aalen bis zur Geschlechtsreife. *Naturwissenschaften*, **59**, 471-472.
- MESKE, C. and CELLARIUS, O. (1973). Artificially produced sexual maturity and observation of sexual differentiation in eels reared in warm water. *Arch. FischWiss.*, **24**, 191-197.
- MESTER, R., GAROFA, T. and ROS, R. (1974). The spawning of two species of sardines *Harengula clupeiola* (CUVIER) and *Harengula humeralis* (CUVIER), subjected to hormonal treatment. *Ciencias (Invest. Mar.), Habana*, **9**, 1-13.
- METZ, C. B. (1956). Mechanisms in fertilization. In T. H. Bullock (Ed.), *Physiological Triggers*. American Physiological Society, Washington, D.C. pp. 17-45.
- MEYER, D. L. (1973). Feeding behavior and ecology of shallow-water unstalked crinoids (Echinodermata) in the Caribbean Sea. *Lond., Mar. Biol.*, **22**, 105-129.
- MEYERS, S. P. (1971). Crustacean ration formulation research. *Feedstuffs, Lond.*, **43**, 27.
- MEYERS, S. P. (1973). Capsulation techniques, development of diets for larval and postlarval aquatic animals reported. *Feedstuffs, Lond.*, **45**, 35.
- MEYERS, S. P., BUTLER, D. P. and HASTINGS, W. H. (1972). Alginates as binders for crustacean rations. *Progee Fish Cult.*, **34**, 9-12.
- MEYERS, S. P., BUTLER, D. P. and SIRINE, G. F. (1971). Encapsulation—a new approach to larval feeding. *Am. Fish. Farmer*, **2**, 15-20.
- MEYERS, S. P., FEDER, W. A. and TSUE, K. M. (1963). Nutritional relationships among certain filamentous fungi and a marine occurring nematode. *Science, N. Y.*, **141**, 520-522.
- MEYERS, S. P., FEDER, W. A. and TSUE, K. M. (1964). Studies of relationships among nematodes, and filamentous fungi in the marine environment. *Dev. ind. Microbiol.*, **5**, 354-364.
- MEYERS, S. P. and HOPPER, B. E. (1966). Attraction of the marine nematode, *Metoncholaimus* sp., to fungal substrates. *Bull. mar. Sci.*, **16**, 143-150.
- MEYERS, S. P. and HOPPER, B. E. (1967). Studies on marine fungal-nematode associations and plant degradation. *Helgoländer wiss. Meeresunters.*, **15**, 270-281.
- MEYERS, S. P. and HOPPER, B. E. (1973). Nematological-microbial interrelationships and estuarine biodegradative processes. In L. H. Stevenson and R. R. Colwell (Eds), *Estuarine Microbial Ecology*. University of South Carolina Press, Columbia, South Carolina. pp. 483-489.
- MEYERS, S. P., HOPPER, B. E. and CEFALU, R. C. (1970). Ecological investigations of the marine nematode, *Metoncholaimus scissus*. *Mar. Biol.*, **6**, 43-47.
- MEYER-WAARDEN, P. F. (1935a). Ein Beitrag zur Laichperiodizität bei der Nordseekrabbe (Granat) *Crangon vulgaris* FABR. *Zool. Anz.*, **109**, 23-32.

- MEYER-WAARDEN, P. F. (1935b). Wachstums- und Altersuntersuchungen an der Nordsee-krabbe (Granat) *Crangon vulgaris* FABR. *Zool. Anz.*, **111**, 145-152.
- MICHELSON, E. H. (1959). A technique for securing and maintaining bacteriologically sterile prosobranch snails. *Trans. Am. microsc. Soc.*, **78**, 256-261.
- MILKMAN, R. (1954). Controlled observation of hatching in *Fundulus heteroclitus*. *Biol. Bull. mar. biol. Lab., Woods Hole*, **107**, 300.
- MILLER, C. A. and WAGTENDONK, W. J. VAN (1956). The essential metabolites of a strain of *Paramecium aurelia* (STOCK 47.8) and a comparison of the growth rate of different strains of *Paramecium aurelia* in axenic culture. *J. gen. Microbiol.*, **15**, 280-291.
- MILLER, H. M. (1931). Alternation of generation in the rotifer *Lecane inermis* BRYCE. I. Life histories of the sexual and non-sexual generation. *Biol. Bull. mar. biol. Lab., Woods Hole*, **60**, 345-381.
- MILLER, R. (1966). Chemotaxis during fertilization in the hydroid *Campanularia*. *J. exp. Zool.*, **162**, 23-44.
- MILLER, R. J. and MANN, K. H. (1973). Ecological energetics of the seaweed zone in a marine bay on the Atlantic coast of Canada. III. Energy transformations by sea urchins. *Mar. Biol.*, **18**, 99-114.
- MILLER, R. M. and RIDGWAY, S. H. (1963). Clinical experience with dolphins and whales. *Small Anim. Clin.*, **3**, 189-193.
- MILLIGAN, H. N. (1916a). Asteroids feeding upon living sea-anemones. *Nature, Lond.*, **96**, 619-620.
- MILLIGAN, H. N. (1916b). Cushion-stars attacking brittlestars. *Zoologist* (Ser. 4), **20**, 79-80.
- MINER, R. W. (1950). *Field Book of Seashore Life*, Putman's Sons, New York.
- MITCHELL, C. W. (1913). Sex determination in *Asplanchna amphora*. *J. exp. Zool.*, **15**, 225-255.
- MITO, S., UKAWA, M. and HIGUCHI, J. (1969). On the egg development and rearing of the larvae of a flounder *Kareius bicoloratus* (BASILEWSKY) with reference to its spawning in the culturing pond. (Jap.) *Bull. Nansei Reg. Fish. Res. Lab.*, **1**, 87-102.
- MITSON, R. B. (1963). Marine fish culture in Britain. V. An electronic device for counting the nauplii of *Artemia salina* L. *J. Cons. perm. int. Explor. Mer.*, **28**, 262-269.
- MIURA, T. and TAKAHASHI, R. M. (1973). Insect developmental inhibitors. 3. Effects on non-target aquatic organisms. *J. econ. Ent.*, **66**, 917-922.
- MIYAZAKI, I. (1938). On a substance which is contained in green algae and induces spawning action of the male oyster. (Preliminary note.) *Bull. Jap. Soc. scient. Fish.*, **7**, 137-138.
- MOCK, C. R. (1971). UJNR Aquaculture Panel Meeting, October, 1971. *Trip Report*, 1-34.
- MOCK, C. R. (1974). Larval culture of penaeid shrimp at the Galveston Biological Laboratory. *NOAA Techn. Rep., NMFS, Circ.*, **388**, 33-40.
- MOCK, C. R. and NEAL, R. A. (in press). Engineering aspects of a closed system for aquaculture. In G. Persoone and E. Jaspers (Eds), *Tenth European Marine Biological Symposium*. Ostend, Belgium, 1975.
- MODIN, J. C. and COX, K. W. (1967). Post-embryonic development of laboratory-reared ocean shrimp, *Pandalus jordani* RATHBUN. *Crustaceana*, **13**, 197-219.
- MOEWUS, L. (1963). Studies on a marine parasitic ciliate as a potential virus vector. In C. H. Oppenheimer (Ed.), *Symposium on Marine Microbiology*. C. C. Thomas, Springfield, Ill. pp. 366-379.
- MOHAMED, K. H. (1970a). Synopsis of biological data on the jumbo tiger prawn *Penaeus monodon* FABRICIUS, 1798. *F.A.O. Fish. Rep.*, **57**, 1251-1266.
- MOHAMED, K. H. (1970b). Synopsis of biological data on the Indian prawn *Penaeus indicus* H. MILNE EDWARDS, 1837. *F.A.O. Fish. Rep.*, **57**, 1267-1288.
- MOHR, E. (1952). Die Robben der europäischen Gewässer. In D. Müller (Ed.), *Monographien der Wildsäugetiere*, Vol. 12. Paul Schöps, Frankfurt. pp. 1-283.
- MOHR, E. (1966). Bemerkungen über *Cystophora cristata* und über Walross-Luftsäcke. *Zool. Gart., Lpz.*, **32**, 28-35.
- MOKRETSOVA, N. D. (1973). Cultivation of trepangs in Peter the Great Bay. *Ryb. Khoz.*, **11**, 7-8.
- MONROY, A. (1965). *Chemistry and Physiology of Fertilization*, Holt, Rinehart and Winston, New York.

- MOORE, D. V. (1960). A modified filtration and aeration unit for experimental snail aquaria. *J. Parasit.*, **46**, 767-768.
- MOORE, H. B. (1934). A comparison of the biology of *Echinus esculentus* in different habitats. I. *J. mar. biol. Ass. U.K.*, **19**, 869-886.
- MOORE, H. B. (1966). Ecology of echinoids. In R. A. Booloottian (Ed.), *Physiology of Echinodermata*. Interscience Publishers, New York. pp. 73-85.
- MOORE, H. B., JUTARE, T., BAUER, J. C. and JONES, J. A. (1963). The biology of *Lytechinus variegatus*. *Bull. mar. Sci. Gulf Caribb.*, **13**, 23-53.
- MOORE, H. B. and LOPEZ, N. N. (1972). Factors controlling variation in the seasonal spawning pattern of *Lytechinus variegatus*. *Mar. Biol.*, **14**, 275-280.
- MOORE, H. F. (1898). Oysters and methods of oyster-culture. *Rep. U.S. Commnr Fish.*, **23**, 263-338.
- MOORE, H. F. (1908a). The commercial sponges and the sponge fisheries. *Bull. Bur. Fish., Wash.*, **28**, 399-511.
- MOORE, H. F. (1908b). A practical method of sponge culture. *Bull. Bur. Fish., Wash.*, **28**, 545-585.
- MOORE, J. A. (1939). The role of temperature in hydranth formation in *Tubularia*. *Biol. Bull. mar. biol. Lab., Woods Hole*, **76**, 104-107.
- MOOTZ, C. A. (1973). Energetics and feeding rates of the larvae of *Menippe mercenaria* SAY. M. S. Thesis, University of Delaware.
- MOOTZ, C. A. and EPIFANIO, C. E. (1974). An energy budget for *Menippe mercenaria* larvae fed *Artemia* nauplii. *Biol. Bull. mar. biol. Lab., Woods Hole*, **146**, 44-45.
- MORALES, P. (1971). Sobre camarón y cria. *Mar Pesca*, **68**, 22-27.
- MORGAN, T. H. (1902). Further experiments on the regeneration of *Tubularia*. *Wilhelm Roux Arch. EntwMech. Org.*, **13**, 528-564.
- MORGAN, T. H. (1903). Some factors in the regeneration of *Tubularia*. *Wilhelm Roux Arch. EntwMech. Org.*, **16**, 125-154.
- MORI, S. and MATUTANI, K. (1952). Studies on the daily rhythmic activity of the starfish *Astropecten polyacanthus* MÜLLER et TROCHEL, and the accompanied physiological rhythms. *Publs Seto mar. biol. Lab.*, **11**, 173-185.
- MORI, Y. and HIRATA, H. (1968). Population growth of marine rotifer, *Brachionus plicatilis*, under the conditions of several photoperiods. *Prog. Notes Farm. Fish. Shibushi Mar. Farm St., Seto-Inland Sea Farm. Fish. Assoc.*, **1**, 1-7. (Mimeo.)
- MORIMOTO, Y. (1970). *Feed Science* (Jap.), Yookendo, Tokyo.
- MORO, L. (1915). Partenogenesi e anfigonia nei Rotiferi. Ric. sperim. sul. *Brachionus pala*. *Bios, Genova*, **2**, 219-264.
- MORRIS, R. W. (1956). Some aspects of the problem of rearing marine fishes. *Bull. Inst. océanogr. Monaco*, **53**, 1-61.
- MORSE, M. (1909). The autotomy of the hydranth of *Tubularia*. *Biol. Bull. mar. biol. Lab., Woods Hole*, **17**, 172-181.
- MORTENSEN, T. (1894). Zur Anatomie und Entwicklung der *Cucumaria glacialis* (LJUNGMAN). *Z. wiss. Zool.*, **57**, 704-732.
- MORTENSEN, T. (1903). Echinoidea. *Dan. Ingolf-Exped.*, **4**, 1-193.
- MORTENSEN, T. (1909). Die Echinoiden. *Di. Südpol.-Exped.*, **11**, 1-113.
- MORTENSEN, T. (1913). On the development of some British echinoderms. *J. mar. biol. Ass. U.K.*, **10**, 1-18.
- MORTENSEN, T. (1920). Studies in the development of crinoids. *Carnegie Inst. Wash., Publs*, **16**, 1-94.
- MORTENSEN, T. (1921). *Studies of the Development and Larval Forms of Echinoderms*, G. E. C. Gad., Copenhagen.
- MORTENSEN, T. (1925). *Goniocidaris umbraculum*. A brood-protecting species. *N.Z. J. Sci. Technol.*, **8**, 192.
- MORTENSEN, T. (1927a). *Handbook of the Echinoderms of the British Isles*, Oxford University Press, Oxford.
- MORTENSEN, T. (1927b). On the postlarval development of some cidarids. *K. danske Vidensk. Selsk. Skr. (Nat. Math. Afd. 8 række)*, **11**, 367-387.

- MORTENSEN, T. (1931). Contributions to the study of the development and larval forms of echinoderms. I & II. *K. danske Vidensk. Selsk. Skr. (Nat. Math. Afd. 9 række)*, **4**, 1-39.
- MORTENSEN, T. (1936). Echinoidea and Ophiuroidea. 'Discovery' *Rep.*, **12**, 199-348.
- MORTENSEN, T. (1938). Contributions to the study of the development and larval forms of echinoderms. *K. danske Vidensk. Selsk. Skr.*, **7**, 1-59.
- MORTENSEN, T. (1950). Echinoidea. *Rep. B.A.N.Z. antarct. Res. Exped. (Ser. B)*, **4**, 297-310.
- MOTOMURA, I. (1953). Secretion of sperm agglutinin in fertilized eggs of the sea urchins. *Expl Cell Res.*, **5**, 187-190.
- MOTOMURA, I. (1960). On the structure of the cortical granule in the sea urchin egg. *Sci. Rep. Tôhoku Univ. (Ser. 4, Biol.)*, **26**, 367-374.
- MOUNIB, M. S., HWANG, P. C. and IDLER, D. R. (1968). Cryogenic preservation of Atlantic cod (*Gadus morhua*) sperm. *J. Fish. Res. Bd Can.*, **25**, 2623-2632.
- MOUSSATCHÉ, H. (1949). On músculo das holotúrias ('*Holothuria grisea*') como método de ensaio biológico para verificar presença de acetilcolina. *Revta bras. Biol.*, **9**, 525.
- MOUSSATCHÉ, H. and ARONSON, M. (1951). Sur l'emploi des holothuries comme méthode d'essai biologique et de dosage de l'acétylcholine. *Revta bras. Biol.*, **11**, 219-221.
- MOYSE, J. (1960). Mass rearing of barnacle cyprids in the laboratory. *Nature, Lond.*, **185**, 120.
- MOYSE, J. (1963). A comparison of the value of various flagellates and diatoms as food for barnacle larvae. *J. Cons. perm. int. Explor. Mer*, **28**, 175-187.
- MOYSE, J. (1964). Studies on the development, behaviour and ecology of Cirripedia. Ph.D. Thesis, University of Wales, Swansea.
- MOYSE, J. and KNIGHT-JONES, E. W. (1967). Biology of cirripede larvae. In Symposium on Crustacea, Part II. *Mar. Biol. Ass., Mandapam, India*. pp. 595-611.
- MÜLLER, H. (1962). Über die Sexualität des Polychaeten *Ophryotrocha puerilis*, ihre Determination und ihren Einfluß auf Drüsentätigkeit und Kauapparatentwicklung. *Z. Morph. Tiere*, **52**, 1-32.
- MÜLLER, W. A. (1961a). Untersuchungen zur Stockdifferenzierung von *Hydractinia echinata*. *Zool. Jb. (Allg. Zool. Physiol. Tiere)*, **69**, 317-324.
- MÜLLER, W. A. (1961b). Untersuchungen zur Ablaufrhythmik des Hydroidpolyphen *Hydractinia echinata*. *Zool. Jb. (Allg. Zool. Physiol. Tiere)*, **69**, 325-332.
- MÜLLER, W. A. (1964). Experimentelle Untersuchungen über Stockentwicklung, Polypendifferenzierung und Sexualchimären bei *Hydractinia echinata*. *Wilhelm Roux Arch. EntwMech. Org.*, **155**, 181-268.
- MÜLLER, W. A. (1967). Differenzierungspotenzen und Geschlechtsstabilität der I-Zellen von *Hydractinia echinata*. *Wilhelm Roux Arch. EntwMech. Org.*, **159**, 412-432.
- MÜLLER, W. A. (1969a). Auslösung der Metamorphose durch Bakterien bei den Larven von *Hydractinia echinata*. *Zool. Jb. (Anat. Ontogenie Tiere)*, **86**, 84-95.
- MÜLLER, W. A. (1969b). Die Steuerung des morphogenetischen Fließgleichgewichts in den Polypen von *Hydractinia echinata*. I. Biologisch-experimentelle Untersuchungen. *Wilhelm Roux Arch. EntwMech. Org.*, **163**, 334-356.
- MÜLLER, W. A. (1973). Metamorphose-Induktion bei Planularlarven. I. Der bakterielle Induktor. *Wilhelm Roux Arch. EntwMech. Org.*, **173**, 107-121.
- MÜLLER, W. A. and BUCHAL, G. (1973). Metamorphose-Induktion bei Planularlarven. II. Induktion durch monovalente Kationen: Die Bedeutung des Gibbs-Donnan-Verhältnisses und der Na⁺/K⁺-ATPase. *Wilhelm Roux Arch. EntwMech. Org.*, **173**, 122-135.
- MULLER, W. A. and LEE, J. J. (1969). Apparent indispensability of bacteria in foraminiferan nutrition. *J. Protozool.*, **16**, 471-478.
- MULLIN, M. M. (1963). Some factors affecting the feeding of marine copepods of the genus *Calanus*. *Limnol. Oceanogr.*, **8**, 239-250.
- MULLIN, M. M. and BROOKS, E. R. (1967). Laboratory culture, growth rate, and feeding behavior of a planktonic marine copepod. *Limnol. Oceanogr.*, **12**, 657-666.
- MULLIN, M. M. and BROOKS, E. R. (1970a). Growth and metabolism of two planktonic, marine copepods as influenced by temperature and type of food. In J. H. Steele (Ed.), *Marine Food Chains*. University of California Press, Berkeley. pp. 74-95.
- MULLIN, M. M. and BROOKS, E. R. (1970b). The ecology of the plankton off La Jolla, California, in the period April through September, 1967. Part VII. Production of the planktonic

- copepod, *Calanus helgolandicus*. *Bull. Scripps Instn Oceanogr.* (techn. Ser.), **17**, 89-103.
- MULLIN, M. M. and BROOKS, E. R. (1970c). The effect of concentration of food on body weight, cumulative ingestion, and rate of growth of the marine copepod *Calanus helgolandicus*. *Limnol. Oceanogr.*, **15**, 748-755.
- MUNDEY, G. R. (1969). Highland lobster farm in operation. *Wild Fishg.*, **18** (9), 38-39.
- MURAKAMI, S. (1941). On the development of the hard parts of a viviparous ophiuran *Stegophiura sculpta* (DUNCAN). *Annotnes zool. jap.*, **20**, 67-77.
- MURAYAMA, S. (1935). On the development of the Japanese abalone, *Haliotis gigantea*. *Coll. Agric. Tokyo Imp. Univ. J.*, **13**, 227-233.
- MURCHELANO, R. A. and BISHOP, J. L. (1969). Bacteriological study of laboratory-reared juvenile American oysters (*Crassostrea virginica*). *J. Invert. Pathol.*, **14**, 321-327.
- MURCHELANO, R. A. and BROWN, C. (1969). Bacterial flora of some algal foods used for rearing bivalve larvae. *J. Fish. Res. Bd Can.*, **26**, 2760-2764.
- MURDOCH, W. W. (1969). Switching in general predators: experiments on predator specificity and stability of prey populations. *Ecol. Monogr.*, **39**, 335-354.
- MURDOCH, W. W. (1971). The developmental response of predators to changes in prey density. *Ecology*, **52**, 132-137.
- MURKEN, J. (in press). Feeding experiments with *Mytilus edulis* L. at small laboratory scale. Feeding of waste organic products from the fish industry of Bremerhaven as a means of recycling biodegradable wastes. In G. Persoone and E. Jaspers (Eds), *Tenth European Marine Biology Symposium*. Ostend, Belgium, 1975.
- MURPHY, H. E. (1923). The life cycle of *Oithona nana* reared experimentally. *Univ. Calif. Publ Zool.*, **22**, 449-454.
- MURRAY, J. W. (1963). Ecological experiments on Foraminifera. *J. mar. biol. Ass. U.K.*, **43**, 621-642.
- MUUS, B. J. (1967). The fauna of Danish estuaries and lagoons. Distribution and ecology of dominating species in the shallow reaches of the mesohaline zone. *Meddr Danm. Fisk.-og Havunders.*, **5**, 1-316.
- MUUS, K. (1966). Notes on the biology of *Protohydra leuckarti* GREEF (Hydroidea, Protohyridae). *Ophelia*, **3**, 141-150.
- MYERS, E. H. (1935). Culture methods for the marine Foraminifera of the littoral zone. *Trans. Am. microsc. Soc.*, **54**, 264-267.
- MYERS, E. H. (1937). Culture methods for marine Foraminifera of the littoral zone. In J. G. Needham, P. S. Galtsoff, F. Lutz and P. L. Welch (Eds), *Culture Methods for Invertebrate Animals*. Comstock Publishing Co., New York. pp. 93-96.
- MYERS, E. H. (1943a). Life activities of Foraminifera in relation to marine ecology. *Proc. Am. phil. Soc.*, **86**, 439-458.
- MYERS, E. H. (1943b). Biology, ecology, and morphogenesis of a pelagic foraminifer. *Stanford Univ. Publ. Biol. Sci.*, **9**, 1-30.
- NACHTSHEIM, H. (1914). Das Problem der Geschlechtsbestimmung bei *Dinophilus*. *Ber. naturf. Ges., Freiburg, Br.*, **21**, 3-13.
- NAGAI, Y. and KANEKO, K. (1975). Culture experiments on the sea urchin *Strongylocentrotus pulcherrimus* fed an artificial diet. *Mar. Biol.*, **29**, 105-108.
- NAGAI, Y. and NAGAI, S. (1973). Feeding factors for the sea anemone *Anthopleura midorii*. *Mar. Biol.*, **18**, 55-60.
- NAGAO, Z. (1962). The polyp and medusa of the hydrozoan *Stauridiosarsia japonica* n. sp., from Akkeshi, Hokkaido. *Annotnes zool. jap.*, **35**, 176-181.
- NAGAO, Z. (1964). The life cycle of the hydromedusa *Nemopsis dofleini* MAAS, with a supplementary note on the life history of *Bougainvillia superciliaris* (L. AGASSIZ). *Annotnes zool. jap.*, **37**, 153-162.
- NAKAJIMA, M., SAWAURA, K., FUJIMOTO, A. and ODA, T. (1965). Foreign bodies in the stomachs of the captive dolphins. *Enoshima Marineland Reports*, **2**, 27.
- NAKAMURA, T. and YOSHINAGA, H. (1962). Sea urchins in the outer-sea of Yamaguchi prefecture. *Aquiculture*, **9**, 189-195.
- NAKANISHI, Y. H., IWASAKI, T., OKIGAKI, T. and KATO, H. (1962). Cytological studies of *Artemia salina*. I. Embryonic development without cell multiplication after the blastula stage in encysted dry eggs. *Annotnes zool. jap.*, **35**, 223-228.

- NAPOLITANO, R. and LILLY, D. L. (1972). Tolerance of *Paramecium* for estuarine conditions. *J. Protozool.*, **19** (Suppl.), 33.
- NARCHI, W. and HEBLING, N. J. (1975). The life cycle of the commensal hydromedusa *Eutima sapinhua* n. sp. *Mar. Biol.*, **30**, 73-78.
- NASH, C. E. (1973). Automated mass-production of *Artemia salina* nauplii for hatcheries. *Aquaculture*, **2**, 289-298.
- NASH, C. E. (1974). Crop selection issues. In J. A. Hanson (Ed.), *Open Sea Mariculture. Perspectives, Problems and Prospects*. Dowden, Hutchinson & Ross, Stroudsburg. pp. 183-210.
- NASH, C. E., KUO, C.-M. and MCCONNELL, S. C. (1974). Operational procedures for rearing larvae of the grey mullet (*Mugil cephalus* L.). *Aquaculture*, **3**, 15-24.
- NASSOGNE, A. (1969). The culture of copepods in the laboratory. *Pubbl. Staz. zool. Napoli*, **37**, 203-218.
- NASSOGNE, A. (1970). Influence of food organisms on the development and culture of pelagic copepods. *Helgoländer wiss. Meeresunters.*, **20**, 333-345.
- NASSONOV, N. B. (1924). Sur l'éponge perforante *Clione stations* et le creusement des galeries dans les valves de l'huître. *Dokl. Akad. Nauk SSSR*, **1924**, 113-115.
- NATHAN, H. A. and LADERMAN, A. D. (1959). Rotifers as biological tools. *Ann. N.Y. Acad. Sci.*, **77**, 96-101.
- NEEDHAM, J. G. (Ed.) (1937). *Culture Methods for Invertebrate Animals*, Comstock Publishing Co., New York.
- NEEDLER, A. W. H. (1941). Oyster farming in Eastern Canada. *Bull. Fish. Res. Bd Can.*, **60**, 1-83.
- NELSON, T. C. (1928). On the distribution of critical temperature for spawning and for ciliary activity in bivalve molluscs. *Science, N.Y.*, **67**, 200.
- NESTEROV, G. A. (1964). Information on the biology and population size of the sea lions (*Eumetopias stelleri*) of the Commander Islands. *Izvestiya TINRO*, **54**, 173-177.
- NEUGEBAUER, W. (1967). Breeding the Southern elephant seal *Mirounga leonina* at Stuttgart Zoo. *Int. Zoo Yb.*, **7**, 152-154.
- NEUNES, H. W. and PONGOLINI, G.-F. (1965). Breeding a pelagic copepod, *Euterpina acutifrons* (DANA), in the laboratory. *Nature, Lond.*, **208**, 571-573.
- NEWELL, G. E. (1948). A contribution to our knowledge of the life history of *Arenicola marina* L. *J. mar. biol. Ass. U.K.*, **27**, 554-580.
- NEWELL, G. E. (1949). The later larval life of *Arenicola marina* L. *J. mar. biol. Ass. U.K.*, **28**, 635-639.
- NEWELL, G. E. (1954). The marine fauna of Whitstable. *Ann. Mag. nat. Hist.* (Ser. 12), **7**, 321-350.
- NEWMAN, H. H. (1925). An experimental analysis of asymmetry in the starfish. *Biol. Bull. mar. biol. Lab., Woods Hole*, **49**, 111-138.
- NEWMAN, M. A. and McGEER, P. L. (1966). The capture and care of a killer whale *Orcinus orca* in British Columbia. *Zoologica, N.Y.*, **51**, 59-70.
- NEWMAN, V. A. (1963). On the introduction of an edible oriental shrimp (Caridea, Palaemonidae) to San Francisco Bay. *Crustaceana*, **5**, 119-132.
- NICHOLAS, W. L., DOUGHERTY, E. C. and HANSEN, E. L. (1959). Axenic cultivation of *Caenorhabditis briggsae* (Nematoda: Rhabditidae) with chemically undefined supplements; comparative studies with related nematodes. *Ann. N.Y. Acad. Sci.*, **77**, 218-236.
- NICHOLAS, W. L., HANSEN, E. L. and DOUGHERTY, E. C. (1962). The B-vitamins required by *Caenorhabditis briggsae* (Rhabditidae). *Nematologica*, **8**, 129-135.
- NICHOLS, D. (1960). The histology and activities of the tube-feet of *Antedon bitida*. *Q. Jl microsc. Sci.*, **101**, 105-117.
- NICHOLS, D. (1962). *Echinoderms*, Hutchinson University Library, London.
- NICOL, E. A. T. (1930). The feeding mechanism, formation of the tube, and physiology of digestion in *Sabella pavonina*. *Trans. R. Soc. Edinb.*, **56**, 537-598.
- NIKITINSKAYA, I. V. (1958). On the onset of active feeding of the larvae of *Clupea harengus pallasi* VAL. (Russ.) *Zool. Zh.*, **37**, 1568-1571.
- NIMURA, Y. (1967). Biology of the brine shrimp. (Jap.) *Bull. Jap. Soc. scient. Fish.*, **33**, 690-702.
- NIMURA, Y. (1968). Note on hatching the cysts of *Artemia*. (Jap.) *Aquiculture*, **16**, 105-115.
- NISHIWAKI, M. (1965). *Whales and Pinnipeds*, University of Tokyo Press, Tokyo.

- NISHIWAKI, M. (1972). General biology. In S. H. Ridgway (Ed.), *Mammals of the Sea*. C. C. Thomas, Springfield. pp. 3-204.
- NONNENMACHER-GODET, J. and DOUGHERTY, E. C. (1964). Incorporation of tritiated thymidine in the cells of *Caenorhabditis briggsae* (Nematoda) reared in axenic culture. *J. Cell. Biol.*, **22**, 281-290.
- NORRIS, K. S. (1965). Trained porpoise released in the open sea. *Science, N. Y.*, **147**, 1048.
- NORRIS, K. S. (Ed.) (1966a). *Whales, Dolphins, and Porpoises*, University of California Press, Berkeley.
- NORRIS, K. S. (1966b). Discussion remarks to 'Round Table: Practical Problems'. In K. S. Norris (Ed.), *Whales, Dolphins, and Porpoises*. University of California Press, Berkeley. p. 649.
- NORTON, T. A. (1973). Oriented growth of *Membranipora membranacea* (L.) on the thallus of *Saccorhiza polyschides* (LIGHTF.) BATT. *J. exp. mar. Biol. Ecol.*, **13**, 91-95.
- NOSE, T. (1971). Spawning of eel in a small aquarium. *Riv. It. Piscip. Ittiop.*, **6**, 25-26.
- NOUMURA, T. and KANATANI, H. (1962). Induction of spawning by radial nerve extracts in some starfishes. *J. Fac. Sci. Tokyo Univ.* (Sect. 4), **9**, 397-402.
- NOUVEL, L. (1939). Observation de l'accouplement chez une espèce de Crevette *Crangon crangon*. *C.r. hebd. Séanc. Acad. Sci., Paris*, **209**, 639-641.
- NOVIKOFF, A. B. (1937). *Sabella vulgaris*. In J. G. Needham (Ed.), *Culture Methods for Invertebrate Animals*. Comstock, New York. pp. 187-191.
- NOVIKOFF, A. B. (1938). Embryonic determination in the annelid, *Sabellaria vulgaris*. I. The differentiation of ectoderm and endoderm when separated through induced exogastrulation. *Biol. Bull. mar. biol. Lab., Woods Hole*, **74**, 198-210.
- NOVIKOFF, A. B. (1939). Surface changes in unfertilized and fertilized eggs of *Sabellaria vulgaris*. *J. exp. Zool.*, **82**, 217-237.
- NOWAK, W. S. W. (1972). *The Lobster (Homaridae) and the Lobster Fisheries: an Interdisciplinary Bibliography*, Marine Sciences Research Laboratory, Tech. Rep. No. 6, University of Newfoundland.
- NOYES, B. (1922). Experimental studies on the life history of a rotifer reproducing parthenogenetically (*Proales decipiens*). *J. exp. Zool.*, **35**, 225.
- NUSSBAUM, M. (1897). Die Entstehung des Geschlechts bei *Hydatina senta*. *Arch. mikrosk. Anat. EntwMech.*, **49**, 227-308.
- NYHOLM, K.-G. (1961). Morphogenesis and biology of the foraminifer *Cibicides lobatulus*. *Zool. Bidr. Upp.*, **33**, 157-196.
- OATEN, A. and MURDOCH, W. W. (1975). Switching, functional response, and stability in predator-prey systems. *Am. Nat.*, **109**, 299-318.
- ŌBA, T. (1964). Studies on the propagation of an abalone, *Haliotis diversicolor supertexta* LISCHKE. II. On the development. (Jap.) *Bull. Jap. Soc. scient. Fish.*, **30**, 809-819.
- ŌBA, T., SATO, H., TANAKA, K. and TOYAMA, T. (1968). Studies on the propagation of an abalone, *Haliotis diversicolor supertexta*. III. On the size of the one-year-old specimen. (Jap.) *Bull. Jap. Soc. scient. Fish.*, **34**, 457-461.
- OCHIAI, A., UMEDA, S. and OGAWA, M. (1974). On the acceleration of maturity of the catadromous female eel by hormone injection, and changes in the liver and blood character. *Bull. Jap. Soc. scient. Fish.*, **40**, 43-50.
- OCHIAI, A., UMEDA, S. and OTA, H. (1972). On the eggs of Japanese eel and induction of maturation by hormone injection. *Jap. J. Ichthyol.*, **19**, 312-316.
- O'CONNELL, C. P. and RAYMOND, L. P. (1970). The effect of food density on survival and growth of early post-yolk-sac larvae of the northern anchovy (*Engraulis mordax* GIRARD) in the laboratory. *J. exp. mar. Biol. Ecol.*, **5**, 187-197.
- O'CONNOR, C. (in press). Open-sea aquaculture of sea urchins. In G. Persoone and E. Jaspers (Eds), *Tenth European Marine Biology Symposium*. Ostend, Belgium, 1975.
- ODELL, D. K. (1975). Breeding biology of the California sea lion, *Zalophus californianus*. *Rapp. P.-v. Réun. Cons. int. Explor. Mer*, **169**, 374-378.
- ODUM, H. T. and ODUM, E. P. (1955). Trophic structure and productivity of a windward coral reef community on Eniwetok Atoll. *Ecol. Monogr.*, **25**, 291-320.
- OEHLE, R. (1916). Amöbenzucht auf reinem Boden. *Arch. Protistenk.*, **37**, 175-190.

- OEHLER, R. (1924). Weitere Mitteilungen über gereinigte Amöben- und Ciliatenzucht. *Arch. Protistenk.*, **49**, 112-134.
- ØRITSLAND, T. (1964). Klappmysshunnens forplantnings-biologi. *Fisken Hav.*, **1**, 1-15.
- OGINO, C., WATANABE, T., KAKINO, J., IWANAGA, N. and MIZUNO, M. (1970). B Vitamin requirements of carp. III. Requirement for biotin. *Bull. Jap. Soc. scient. Fish.*, **36**, 734-740.
- OGLESBY, L. C. (1970). Studies on the salt and water balance of *Nereis diversicolor*. I. Steady-state parameters. *Comp. Biochem. Physiol.*, **36**, 449-466.
- OHSIMA, H. (1915). Report on the holothurians collected by the United States fisheries steamer 'Albatross' in the northwestern Pacific during the summer of 1906. *Proc. U.S. natn. Mus.*, **48**, 213-292.
- OHSIMA, H. (1916). A new case of brood-caring in holothurians. *Annotnes zool. jap.*, **9**, 121-124.
- OHSIMA, H. and IKEDA, H. (1934). Sexual size dimorphism in *Archaster typicus*. *Proc. imp. Acad. Japan*, **10**, 180-183.
- OHSIMA, Y., ISHIKAWA, N. and TANAKA, Z. (1957). Feeding habits of *Strongylocentrotus pulcherrimus* and *Heliocidaris crassipina*. *Aquiculture*, **5**, 26-30.
- OKADA, K. (1950). An improved method of artificial insemination on some marine eggs. *Sci. Rep. Tohoku Univ.* (Ser. IV, Biol.), **18**, 262-269.
- OKADA, Y. K. (1927). Note sur l'ontogenie de '*Carybdea rostoni*' HAACKE. *Bull. biol. Fr. Belg.*, **61**, 241-263.
- OKAMOTO, R. (1969). Rearing of red sea bream larvae. Symposium on Culture and Propagation of Sea Breams. *Bull. Jap. Soc. scient. Fish.*, **35**, 563-566, 603.
- OKAZAKI, K. (1975). Normal development to metamorphosis. In G. Czihak (Ed.), *The Sea Urchin Embryo*. Springer-Verlag, Berlin. pp. 177-232.
- OLIVEREAU, M. (1961). Maturation sexuelle de l'anguille mâle en eau douce. *C.r. hebd. Séanc. Soc. Acad. Sci., Paris*, **252**, 3660-3662.
- OLIVEREAU, M. and HERLANT, M. (1960). Etude de l'hypophyse de l'anguille mâle au cours de la reproduction. *C.r. Séanc. Soc. Biol.*, **154**, 706-709.
- OLSEN, D. A. (1962). A general description of the Seven Seas Panorama Dolphin and Seal Show at Brookfield Zoo, Chicago, USA. *Int. Zoo Yb.*, **4**, 35-38.
- OMORI, M. (1970). Variations of length, weight, respiratory rate, and chemical composition of *Calanus cristatus* in relation to its food and feeding. In J. H. Steele (Ed.), *Marine Food Chains*. University of California Press, Berkeley. pp. 113-126.
- OMORI, M. (1971). Preliminary rearing experiments on the larvae of *Sergestes lucens* (Penaedia, Natantia, Decapoda). *Mar. Biol.*, **9**, 228-234.
- OMORI, M. (1973). Cultivation of marine copepods. *Bull. Plankton Soc. Japan*, **20**, 3-11.
- ONG, K. S. (1966a). The early developmental stages of *Scylla serrata* FORSKÅL (Crustacea, Portunidae) reared in the laboratory. *Proc. Indo-Pacif. Fish. Coun.*, **11**, 135-146.
- ONG, K. S. (1966b). Observations on the postlarval life history of *Scylla serrata* FORSKÅL, reared in the laboratory. *Malay. agric. J.*, **45**, 429-443.
- ONG, K. S. (1967). A preliminary study of the early larval development of the spiny lobster *Panulirus polyphagus* (HERBST). *Malay. agric. J.*, **46**, 183-190.
- ONG, K. S. (1969). The laboratory rearing of the larval stages of a marine prawn, *Metapenaeus ensis* (DE HAAN). *Malay. agric. J.*, **47**, 1-20.
- OOSAWA, T. and KAWANO, T. (1971). Outline of the marine yeast and its culturing method. (Jap.) *Kaiyo-Kaihatsu*, **4**, 1-8.
- OPPENHEIMER, C. H. (1955). The effect of marine bacteria on the development and hatching of pelagic fish eggs, and the control of such bacteria by antibiotics. *Copeia*, **1955**, 43-49.
- ORCUTT, H. G. (1950). The life history of the starry flounder, *Platichthys stellatus* (PALLAS). *Calif. Fish Game, Fish Bull.*, **78**, 1-64.
- ORTON, J. H. (1912). The mode of feeding of *Crepidula*, with an account of the current-producing mechanism in the mantle cavity, and some remarks on the mode of feeding in gastropods and lamellibranchs. *J. mar. biol. Ass. U.K.*, **9**, 444-478.
- ORTON, J. H. (1914). Preliminary account of a contribution to an evaluation of the sea. *J. mar. biol. Ass. U.K.*, **10**, 312-326.
- OSANAI, K. (1975). Handling Japanese sea urchins and their embryos. In G. Czihak (Ed.), *The Sea Urchin Embryo*. Springer-Verlag, Berlin. pp. 26-40.

- OSTERUD, H. L. (1918). Preliminary observations on the development of *Leptasterias hexactis*. *Publs Puget Sound mar. biol. Stn.*, **2**, 1-16.
- OTT, A. G. and HORTON, H. F. (1971a). Fertilization of chinook and coho salmon with cryo-preserved sperm. *J. Fish. Res. Bd Can.*, **28**, 745-748.
- OTT, A. G. and HORTON, H. F. (1971b). Fertilization of steelhead trout (*Salmo gairdnerii*) eggs with cryo-preserved sperm. *J. Fish. Res. Bd Can.*, **28**, 1915-1918.
- OTTO, R. G. (1971). Effects of salinity on the survival and growth of pre-smolt coho salmon (*Oncorhynchus kisutch*). *J. Fish. Res. Bd Can.*, **28**, 343-349.
- PAFFENHÖFER, G.-A. (1968). Nahrungsaufnahme, Stoffumsatz und Energiehaushalt des marinen Hydroidpolyphen *Clava multicornis*. *Helgoländer wiss. Meeresunters.*, **18**, 1-44.
- PAFFENHÖFER, G.-A. (1970). Cultivation of *Calanus helgolandicus* under controlled conditions. *Helgoländer wiss. Meeresunters.*, **20**, 346-359.
- PAFFENHÖFER, G.-A. (1971). Grazing and ingestion rates of nauplii, copepodids and adults of the marine planktonic copepod *Calanus helgolandicus*. *Mar. Biol.*, **11**, 286-298.
- PALINCZAR, E. E. (1959). Nutritional effects of nucleic acids and nucleic acid components on cultures of the suctorian *Podophrya collini*. *J. Protozool.*, **6**, 195-201.
- PALINCZAR, E. E. and PALINCZAR, J. S. (1960). The effect of 8-azaguanine and chloramphenicol on the regression-replacement cycle of hydranths. *Biol. Bull. mar. biol. Lab., Woods Hole*, **119**, 329-330.
- PALMER, L. (1937). The shedding reaction in *Arbacia*. *Physiol. Zool.*, **10**, 352-367.
- PANDIAN, T. J. (1975). Mechanisms of heterotrophy. In O. Kinne (Ed.), *Marine Ecology*, Vol. II, Physiological Mechanisms, Part 1. Wiley, London. pp. 61-249.
- PANINA, G. K. (1966). Food of Steller sea lion and seals on Kuril Islands. *Izvestiya TINRO*, **58**, 235-236.
- PAPE, A. (1935). Beiträge zur Naturgeschichte von *Platessa pseudofolesus*, ein Bastard zwischen Scholle und Flunder. *Wiss. Meeresunters.* (Kiel), **22**, 53-88.
- PARKER, G. H. (1910). The reactions of sponges with a consideration of the origin of the nervous system. *J. exp. Zool.*, **8**, 1-41.
- PARKER, J. C. (in press). An intensive culture system for penaeid shrimp. In G. Persoone and E. Jaspers (Eds), *Tenth European Marine Biology Symposium*. Ostend, Belgium, 1975.
- PARSONS, J. (1974). Advantages in tray cultivation of Pacific oysters (*Crassostrea gigas*) in Strangford Lough, N. Ireland. *Aquaculture*, **3**, 221-229.
- PARSONS, T. R., STEPHENS, K. and STRICKLAND, J. D. H. (1961). On the chemical composition of eleven species of marine phytoplankters. *J. Fish. Res. Bd Can.*, **18**, 1007-1016.
- PATASHNIK, M. and KANGAS, P. (1970). Tek-food—a pasteurized whole fish ration for captive marine mammals. *Seattle, Technological Labs, Bur. Comm. Fisheries, U.S. Dept. of Interior*. (Quoted in RIDGWAY, 1972b.)
- PATEL, B. and CRISP, D. J. (1960a). The influence of temperature on the breeding and the moulting activities of some warm-water species of operculate barnacles. *J. mar. biol. Ass. U.K.*, **39**, 667-680.
- PATEL, B. and CRISP, D. J. (1960b). Rate of development of the embryos of several species of barnacles. *Physiol. Zool.*, **33**, 104-119.
- PAULBITSKI, P. A. and MAGUIRE, T. D. (1972). Tagging harbor seals in San Francisco Bay (California, USA). In *Proceedings of the 9th Annual Conference on Biological Sonar and Diving Mammals*. Biological Sonar Laboratory, Fremont, California. pp. 53-72.
- PAULIAN, P. (1960). Sur la taille à la naissance et la durée de l'allaitement chez le Léopard de mer (*Hydrurga leptonyx* DE BLAINVILLE). *Mammalia*, **24**, 468-475.
- PAULSON, T. C. and SCHELTEMA, R. S. (1968). Selective feeding on algal cells by the veliger larvae of *Nassarius obsoletus* (Gastropoda, Prosobranchia). *Biol. Bull. mar. biol. Lab., Woods Hole*, **134**, 481-489.
- PAVILLON, J.-F. (1976). Action de trois substances supposées ectoérines (riboflavine, acide glutamique, glycine) sur la cinétique du développement de l'oeuf et al croissance de la larve de deux espèces d'échinides, *Arbacia lixula* et *Paracentrotus lividus*. *Mar. Biol.*, **34**, 67-75.
- PAVLOVSKAYA, T. W. (1969). Experiments on algal nutrition of some Black Sea ciliates. *Int. Congr. Protozool. (Leningrad)*, **3**, 174.

- PAWSON, D. L. (1966). Ecology of holothurians. In R. A. Booloottian (Ed.), *Physiology of Echinodermata*. Interscience Publishers, New York. pp. 63-71.
- PEARCY, W. C. and FORSS, C. A. (1966). Depth distribution of oceanic shrimps (Decapoda; Natantia) off Oregon. *J. Fish. Res. Bd Can.*, **23**, 1135-1143.
- PEARCY, W. C. and FORSS, C. A. (1969). The oceanic shrimp *Sergestes similis* off the Oregon coast. *Limnol. Oceanogr.*, **14**, 755-765.
- PEARCY, W. C., THEILACKER, G. H. and LASKER, R. (1969). Oxygen consumption of *Euphausia pacifica*: The lack of a diel rhythm or light-dark effect, with a comparison of experimental techniques. *Limnol. Oceanogr.*, **14**, 219-223.
- PEARSE, J. S. (1965). Reproductive periodicities in several contrasting populations of *Odontaster validus* KOHLER, a common antarctic asteroid. *Biology of the Antarctic Seas II. Antarct. Res. Ser.*, **5**, 39-85.
- PEARSE, J. S. and GIESE, A. C. (1966). Food, reproduction and organic constitution of the common Antarctic echinoid *Sterechinus neumayeri* (MEISSNER). *Biol. Bull. mar. biol. Lab., Woods Hole*, **130**, 387-401.
- PEARSE, J. S. and PEARSE, V. B. (1973). Removal of glycine from solution by the sea urchin *Strongylocentrotus purpuratus*. *Mar. Biol.*, **19**, 281-284.
- PEARSE, V. B. (1971). Sources of carbon in the skeleton of the coral *Fungia scutaria*. In H. M. Lenhoff, L. Muscatine and L. V. Davis (Eds), *Experimental Coelenterate Biology*. University of Hawaii Press, Honolulu. pp. 239-245.
- PEARSON, A. K. and ENDERS, R. K. (1951). Further observations on the reproduction of the Alaskan fur seal. *Anat. Rec.*, **111**, 695-712.
- PEARSON, J. C. (1939). The early life histories of some American Penaeidae, chiefly the commercial shrimp *Penaeus setiferus* (LINN.). *Bull. Bur. Fish., Wash.*, **49**, 1-73.
- PEARSON, R. G. and ENDEAN, R. (1969). A preliminary study on the coral predator *Acanthaster planci* (L.) (Asteroidea) on the Great Barrier Reef. *Fish. Notes, Dept. Harbours Marine*, **3**, 27-55.
- PEPPER, R. L. and DEFRAN, R. H. (1975). *Dolphin Trainer's Handbook*, Naval Undersea Center, San Diego, California.
- PÉQUIGNAT, E. (1966a). Skin digestion, and epidermal absorption in regular and irregular urchins. *Nature, Lond.*, **210**, 397-399.
- PÉQUIGNAT, E. (1966b). Observations sur les cellules mobiles d'*Echinocardium cardium* et de *Psammechinus*. *Bull. Soc. linn. Normandie* (10e Sér.), **9**, 210-219.
- PÉQUIGNAT, E. (1969). Absorption d'acides aminés dissous et de particules en suspension par les oursins. *C.r. Séanc. Soc. Biol.*, **163**, 101-104.
- PÉQUIGNAT, E. (1970). Biologie des *Echinocardium* de la Baie de Seine. Nouvelles recherches sur la digestion cutanée des échinides et stellerides. *Forma Functio*, **2**, 121-168.
- PÉQUIGNAT, E. (1972). Some new data on skin-digestion and absorption in urchins and sea-stars (*Asterias* and *Henricia*). *Mar. Biol.*, **12**, 28-41.
- PÉQUIGNAT, E. and TIFFON, Y. (1967). Mise en évidence d'une activité amylolytique cutanée chez les échinides. *C.r. hebd. Séanc. Acad. Sci., Paris*, **364**, 3014-3015.
- PEREZ, C. (1920). Un Élevage de Scyphistomes de *Cyanea capillata*. *Bull. biol. Fr. Belg.*, **54**, 168-178.
- PEREZ-FARFANTE, I. (1970). Sinopsis de batos biológicos sobre el camarón blanco *Penaeus schmitti* BURKENROAD, 1936. *F.A.O. Fish. Rep.*, **57**, 1417-1438.
- PÉREZ PEREZ, D. and ROS, R. M. (1974). Experimental cultivation of post-larvae of the white shrimp *Penaeus schmitti* BURKENROAD. *Ciencias (Invest. Mar.)*, *Habana*, **10**, 1-42.
- PERKINS, E. J. (1958). The food relationships of the microbenthos with particular reference to that found at Whitstable, Kent. *Ann. Mag. nat. Hist.* (Ser. 13), **1**, 64-77.
- PERRIER, E. (1891). Stellérides. *Mission scient. Cap Horn Zool.*, **6**, 6-198.
- PERSOONE, G. and DEFLAECIE, M. (1972). Influence de quelques facteurs écologiques sur la vitesse de reproduction du cilié hypotriche *Euplotes vannus* MULLER. *Protistologica*, **8**, 427-433.
- PERSOONE, G. and SORGELOOS, P. (1972). An improved separator box for *Artemia* nauplii and other phototactic invertebrates. *Helgoländer wiss. Meeresunters.*, **23**, 243-247.
- PETERSON, R. S. (1968). Social behavior in pinnipeds with particular reference to the

- Northern fur seal. In R. J. Harrison, R. C. Hubbard, R. S. Peterson, C. E. Rice and R. J. Schusterman (Eds), *The Behavior and Physiology of Pinnipeds*. Appleton-Century-Crofts, New York. pp. 3-53.
- PETERSON, R. S. and BARTHOLOMEW, G. A. (1967). The natural history and behaviour of the California sea lion. *Am. Soc. Mammal Spec. Publ.*, **1**, 1-79.
- PETTIBONE, M. H. (1963). Marine polychaete worms of the New England region. Part I. *Bull. U.S. natn. Mus.*, **227**, 1-356.
- PFANNENSTIEL, H.-D. (1973). Zur sexuellen Differenzierung von *Ophryotrocha puerilis* (Polychaeta: Eunicidae). *Mar. Biol.*, **20**, 245-258.
- PHILLIPPI, R. A. (1870). Neue Seesterne aus Chile. *Arch. Naturgesch.*, **36**, 268-275.
- PHILLIPS, A. M., JR. (1972). Calorie and energy requirement. In J. E. Halver (Ed.), *Fish Nutrition*. Academic Press, New York. pp. 1-28.
- PHILLIPS, G. C. (1971). Incubation of the English prawn *Palaemon serratus*. *J. mar. biol. Ass. U.K.*, **51**, 43-48.
- PHILLIPS, G. C. (1972). Marking shrimps and prawns by latex injection. *Crustaceana*, **22**, 84-86.
- PIATIGORSKY, J. (1975). Gametogenesis. In G. Czihak (Ed.), *The Sea Urchin Embryo*. Springer-Verlag, Berlin. pp. 42-98.
- PICKFORD, G. E. and ATZ, J. W. (1957). *The Physiology of the Pituitary Gland of Fishes*, Zoological Society of New York, New York.
- PIERCE, S., LEE, J. J., TENTCHOFF, M. and MULLER, W. A. (1961). The influence of nutrition on the morphology of a monothal(a)mic foraminifer. *J. Protozool.*, **8** (Suppl.), 8.
- PIKE, G. C. (1958). Food of the northern sea lion, *Eumetopias jubata*. *Prog. Rep. Pacif. Cst Stns.*, **112**, 18-20.
- PILKINGTON, M. C. and FRETTER, V. (1970). Some factors affecting the growth of prosobranch veligers. *Helgoländer wiss. Meeresunters.*, **20**, 576-593.
- PILLERI, G. (1970). The capture and transport to Switzerland of two live *Platanista gangetica* from the Indus River. In G. Pilleri (Ed.), *Investigations on Cetacea*, Vol. II. Prof. G. Pilleri, Waldau-Berne. pp. 61-68.
- PILLERI, G. (1972). *Poppiana argentinianus* RATHBUN, 1906 (Crustacea, Decapoda) in the stomach contents of *Inia geoffrensis* from the Río Ibaré, Bolivia. In G. Pilleri (Ed.), *Investigations on Cetacea*, Vol. IV. Prof. G. Pilleri, Waldau-Berne. pp. 105-106.
- PILLERI, G. and GIER, M. (1975). On the taxonomy and ecology of the finless black porpoise, *Neophocoena* (Cetacea, Delphinidae). *Mammalia*, **39**, 657-673.
- PILLERI, G. and ZBINDEN, K. (1973-74). Size and ecology of the dolphin population (*Platanista indi*) between the Sukkur and Guddu Barrages, Indus River. In G. Pilleri (Ed.), *Investigations on Cetacea*, Vol. V. Prof. G. Pilleri, Waldau-Berne. pp. 59-69.
- PILSON, M. E. Q. and KELLY, A. L. (1962). Composition of the milk from *Zalophus californianus*, the California sea lion. *Science, N.Y.*, **135**, 104-105.
- PILSON, M. E. Q. and WALLER, D. W. (1970). Composition of milk from spotted and spinner porpoises. *J. Mammal.*, **51**, 74-79.
- PINCEMIN, J. M. (1971). The microbial ecology of the activated sludge process. *Symp. Soc. appl. Bact.*, **1**, 123-147.
- PLAGMANN, J. (1939). Ernährungsbiologie der Garnele (*Crangon vulgaris* FABR.). *Helgoländer wiss. Meeresunters.*, **2**, 113-162.
- POIRIER, L. (1974). Study on the possibilities of mytiliculture and oestreculture development at the Iles de la Madeleine. *Rapp. Annu. Dir. Rech. Dir. Gén., Pêches Marit. (Que. Prov.)*, **1974**, 39-45.
- POIZAT, C. (1972). Méthodes d'élevage des gastéropodes opisthobranches de petites et moyennes dimensions. Mise au point d'un circuit fermé en eau de mer. Premiers résultats. *Tethys*, **4**, 251-268.
- PONOMAREVA, L. A. (1959). Reproduction of Euphausiidae of the Sea of Japan and development of their early larval stages. (Russ.) *Zool. Zh.*, **38**, 1643-1662.
- POPOV, G. V. (1953). Data for a study of the defense reflexes in young fish. *Zh. vjssh. nerv. Deyat.*, **3**. (Quoted in RADAkov, 1972.)
- POPPER, D., GORDIN, H. and KISSIL, G. W. (1973). Fertilization and hatching of rabbitfish, *Siganus rivulatus*. *Aquaculture*, **2**, 37-44.
- POSTON, H. A. and LIVINGSTON, D. L. (1969). The effect of continuous darkness and continuous

- light on the functional sexual maturity of brook trout during their second reproductive cycle. *Cortland (New York) Hatchery Rep.*, **38**, 25-29.
- POULET, S. A. (1974). Seasonal grazing of *Pseudocalanus minutus* on particles. *Mar. Biol.*, **25**, 109-123.
- POULTER, T. C. (1965). Derivation of a simple equation for determination of the weight of a seal or sea lion from measurements of its length and girth. *Progress Report 1965 (Echo Ranging Signals of Sea Lions and Seals)*. Stanford Research Institute, Menlo Park, California.
- POULTER, T. C., PINNER, T. C., JENNINGS, R. and HUBBARD, R. C. (1965). The rearing of Steller sea lions. In C. Rice (Ed.), *Proceedings of the 2nd Annual Conference on Biological Sonar and Diving Mammals*. Stanford Research Institute, Menlo Park, California. pp. 49-62.
- POURBAIX, N. (1931). Contribution à l'étude de la nutrition chez les Spongiaires (Éponges Siliceuses). *Bull. Salammbô*, **23**, 1-19.
- POURBAIX, N. (1932a). Note sur la nutrition bactérienne des Éponges. *Ann. Soc. Roy. Zool. Belg.*, **63**, 11-15.
- POURBAIX, N. (1932b). Nota sobre la nutrición bacteriana de la esponjas. *Notas Resúm. Inst. esp. Oceanogr.* (Ser. 2), **62**, 1-4.
- POURBAIX, N. (1933a). Mecanisme de la nutrition chez le Spongillidae. *Ann. Soc. Roy. Zool. Belg.*, **64**, 11-20.
- POURBAIX, N. (1933b). Recherches sur la nutrition des Spongiaires. *Notas Resúm. Inst. esp. Oceanogr.* (Ser. 2), **69**, 1-42.
- POURNELLE, G. H. (1962). The Northern elephant seal, *Mirounga angustirostris* GILL, in the San Diego Zoo. *Int. Zoo Yb.*, **4**, 32-33.
- POURRIOT, R. (1965a). Sur la déterminism du mode de reproduction chez les Rotifères. *Schweiz. Z. Hydrol.*, **27**, 76-87.
- POURRIOT, R. (1965b). Recherches sur l'écologie des rotifères. *Vie Milieu*, **21** (Suppl.), 1-224.
- POWELL, D. C. (1970). An experimental tank for pelagic sharks at Sea World, San Diego. *Int. Zoo Yb.*, **10**, 62-63.
- POWNALL, P. C. (1974). Port Broughton prawn farm well under way. *Aust. Fish.*, **33**, 11-13.
- PRESCOTT, J. H. and CORNELL, L. H. (1975). Care of pinnipeds in captivity. *Rapp. P.-v. Réun. Cons. int. Explor. Mer*, **169**, 324-326.
- PRIM, P. and LAWRENCE, J. M. (1975). Utilization of marine plants and their constituents by bacteria isolated from the gut of echinoids (Echinodermata). *Mar. Biol.*, **33**, 167-173.
- PRINGSHEIM, E. G. (1956). Micro-organisms from decaying seaweed. *Nature, Lond.*, **178**, 480-481.
- PROUHO, H. (1890). Recherches sur la larve de la *Flustrella hispida* (GRAY). *Archs Zool. exp. gén.* (Sér. 2), **8**, 409-459.
- PROVASOLI, L. (1958). Nutrition and ecology of protozoa and algae. *Ann. Rev. Microbiol.*, **12**, 279-308.
- PROVASOLI, L. (1968). Media and prospects for the cultivation of marine algae. In A. Watanabe and A. Hattori (Eds), *Cultures and Collections of Algae*, Proc. U.S.-Japan Conf. Hakone, September 1966. *Jap. Soc. Plant Physiol.*, pp. 63-75.
- PROVASOLI, L. and GOLD, K. (1959). *Gyrodinium cohnii*, an assay organism for thiamine and biotin. *Preprints, Intern. Oceanogr. Congress, A.A.A.S.* Washington, pp. 931-933.
- PROVASOLI, L. and GOLD, K. (1962). Nutrition of the American strain of *Gyrodinium cohnii*. *Arch. Mikrobiol.*, **42**, 196-203.
- PROVASOLI, L., MCLAUGHLIN, J. J. A. and DROOF, M. R. (1957). The development of artificial media for marine algae. *Arch. Mikrobiol.*, **25**, 392-428.
- PROVASOLI, L. and SHIRAIISHI, K. (1959). Axenic cultivation of the brine shrimp *Artemia salina*. *Biol. Bull. mar. biol. Lab., Woods Hole*, **117**, 347-355.
- PROVASOLI, L., SHIRAIISHI, K. and LANCE, J. R. (1959). Nutritional idiosyncrasies of *Artemia salina* and *Tigriopus* in monoxenic culture. *Ann. N.Y. Acad. Sci.*, **77**, 250-261.
- PROVASOLI, L., YAMASU, T. and MANTON, I. (1968). Experiments on the resynthesis of symbiosis in *Convoluta roscoffensis* with different flagellate cultures. *J. mar. biol. Ass. U.K.*, **48**, 465-479.
- PROVENZANO, A. J., JR. and RICE, A. L. (1964). The larval stages of *Pagurus marshi* BENEDICT (Decapoda, Anomura) reared in the laboratory. *Crustaceana*, **7**, 217-235.

- PRUGININ, Y. (1967a). The culture of carp and *Tilapia* hybrids in Uganda. *F.A.O. Fish. Rep.*, **44**, 223-229.
- PRUGININ, Y. (1967b). Report to the government of Uganda on the experimental fish culture project in Uganda, 1965-1966. *FAO/UNDP (TA)*, **2446**, 1-16.
- PRUGININ, Y., ROTHBARD, S., WOHLFAHRTH, G., HALEVY, A., MOAV, R. and HULATA, G. (1975). All-male broods of *Tilapia nilotica* × *T. aurea* hybrids. *Aquaculture*, **6**, 11-21.
- PRYATHERCH, H. F. (1924). Experiments in the artificial propagation of oysters. *U.S. Bur. Fish. U.S. Comm. Fish.*, **1923** (App. 11), 1-14.
- PRYATHERCH, H. F. (1934). The role of copper in the setting, metamorphosis, and distribution of the American oyster, *Ostrea virginica*. *Ecol. Monogr.*, **4**, 47-107.
- PUCKETT, W. O. (1935). The effects of x-irradiation on the regeneration of the hydroid *Pennaria tiarella*. *Anat. Rec.*, **64**, 30.
- PÜTTER, A. (1914). Der Stoffwechsel der Kieselschwämme. *Z. allg. Physiol.*, **16**, 65-114.
- PULLIN, R. S. V. (1972). The storage of plaice (*Pleuronectes platessa*) sperm at low temperatures. *Aquaculture*, **1**, 279-283.
- PUNNETT, R. C. (1906). Sex-determination in *Hydatina*, with some remarks on parthenogenesis. *Proc. R. Soc. (B)*, **78**, 223-231.
- PURDIE, P. (1885). On the chemical composition of the milk of the porpoise. *Rep. Br. Ass. Advmt Sci.*, **P 1072** (Quoted from ARVY, 1973-74.)
- PURDOM, C. E. (1969). Radiation-induced gynogenesis and androgenesis in fish. *Heredity, Lond.*, **24**, 431-444.
- PURDOM, C. E. and LINCOLN, R. F. (1974). Gynogenesis in hybrids within the Pleuronectidae. In J. H. S. Blaxter (Ed.), *The Early Life History of Fish*. Springer-Verlag, Berlin. pp. 537-544.
- PYEFINCH, K. A. and MOTT, J. C. (1948). The sensitivity of barnacles and their larvae to copper and mercury. *J. exp. Biol.*, **25**, 276-298.
- QASIM, S. Z. (1955). Rearing experiments on marine teleost larvae and evidence of their need for sleep. *Nature, Lond.*, **175**, 217-218.
- QASIM, S. Z. (1959). Laboratory experiments on some factors affecting the survival of marine teleost larvae. *J. mar. biol. Ass. India*, **1**, 13-25.
- QUATREFAGES, D. DE (1842). Sur quelques faits relatifs à l'histoire des animaux invertébrés. *C.r. hebd. Séanc. Acad. Sci., Paris*, **15**, 798.
- QUAYLE, D. B. (1969). Pacific oyster culture in British Columbia. *Bull. Fish. Res. Bd Can.*, **169**, 1-193.
- QUAYLE, D. B. (1971). Pacific oyster raft culture in British Columbia. *Bull. Fish. Res. Bd Can.*, **178**, 1-34.
- RADAKOV, D. V. (1970). *Characteristics of Schooling Behavior in Fish*, 'Nauka' Publishing House, Moscow.
- RADAKOV, D. V. (1972). *Stainost' ryb kak ekologicheskoe yavlenie*, Izdatel' stvo 'Nauka', Moscow. (Translation 1973: *Schooling in the Ecology of Fish*, Wiley & Sons, New York.)
- RAE, B. B. (1960). Seals and the Scottish fisheries. *Mar. Res.*, **2**, 1-39.
- RAJA BAI NAIDU, K. G. (1955). The early development of *Scylla serrata* (FORSK.) DE HAAN and *Neptunus sanguinolentus* (HERBST). *Indian J. Fish.*, **2**, 67-76.
- RAMENOFSKY, M., FAULKNER, D. J. and IRELAND, C. (1974). Effect of juvenile hormone on cirriped metamorphosis. *Biochem. biophys. Res. Commun.*, **60**, 172-178.
- RAND, R. W. (1955). Reproduction in the female Cape fur seal, *Arctocephalus pusillus* (SCHREBER). *Proc. zool. Soc. Lond.*, **124**, 717-740.
- RAND, R. W. (1956). The Cape fur seal, *Arctocephalus pusillus* (SCHREBER): its general characteristics and moult. *Union S. Africa Dept. Comm. Indust. Div. Fish. Invest. Rep.*, **21**, 1-52.
- RAND, R. W. (1959). The Cape fur seal (*Arctocephalus pusillus*), distribution, abundance, and feeding habits off the southwestern coast of the Cape Province. *Union S. Africa Dept. Comm. Indust. Div. Fish. Invest. Rep.*, **34**, 1-75.
- RAO, M. V. N. (1971). Biology of a new species of *Amoeba*. *J. Protozool.*, **18** (Suppl.), 30.
- RAPHAEL, Y. I. (1970). A preliminary report on brackish water pond culture of *Scylla serrata* in Ceylon. *Proc. Indo-Pacif. Fish. Coun. 14th Session*, Document IPFC/C70/Symp. 21.

- RASMONT, R. (1961). Une technique de culture des éponges d'eau douce en milieu contrôlé. *Annls Soc. r. zool. Belg.*, **91**, 147-155.
- RASMONT, R. (1963). Le rôle de la taille et de la nutrition dans le déterminisme de la gemmulation chez les Spongillides. *Devl Biol.*, **8**, 243-271.
- RASMONT, R. (1968a). Porifera: Nutrition and digestion. In M. Florin and B. T. Scheer (Eds), *Chemical Zoology*, Vol. II. Academic Press, New York. pp. 43-51.
- RASMONT, R. (1968b). Porifera: Chemical aspects of hibernation. In M. Florin and B. T. Scheer (Eds), *Chemical Zoology*, Vol. II. Academic Press, New York. pp. 65-77.
- RASMUSSEN, B. (1957). Exploration and protection of the East Greenland seal herds. *Norsk Hvalfangsttid.*, **2**, 45-59.
- RASMUSSEN, B. (1965). On taxonomy and biology of the North Atlantic species of the asteroid genus *Henricia* GRAY. *Meddr Danm. Fisk.-og Havunders.*, **4**, 157-213.
- RASMUSSEN, L. and KLUDT, T. A. (1970). Particulate material as a prerequisite for rapid cell multiplication in *Tetrahymena* cultures. *Expl Cell Res.*, **59**, 457-463.
- RATHBUN, R. (1886). Notes on the lobster culture. *Bull. U.S. Fish Commn*, **6**, 17-32.
- RAUCH, H. E., BOTSFORD, L. W. and SHLESER, R. (1974). The use of estimation theory to predict the growth of crabs and lobsters. Unpublished manuscript, presented at the *Fifth Symposium on Nonlinear Estimation and its Applications*. San Diego, California.
- RAUSCHENPLAT, E. (1901). Über die Nahrung von Tieren aus der Kieler Bucht. *Wiss. Meeresunters. Abt. Kiel*, **5**, 85-151.
- RAY, C. (1966). Discussion remarks to 'Round Table: Practical Problems'. In K. S. Norris (Ed.), *Whales, Dolphins, and Porpoises*. University of California Press, Berkeley. p. 650.
- RAY, C. and FAY, F. H. (1968). Influence of climate on the distribution of walrus, *Odobenus rosmarus* (LINNAEUS). II. Evidence from physiological characteristics. *Zoologica, N.Y.*, **53**.
- RAYMONT, J. E. G. and GROSS, F. (1942). On the breeding and feeding of *Calanus finmarchicus* under laboratory conditions. *Proc. R. Soc. Edinb. (B)*, **62**, 267-287.
- RAYMONT, J. E. G. and MILLER, R. S. (1962). Production of marine zooplankton with fertilization in an enclosed body of sea water. *Int. Revue ges. Hydrobiol.*, **47**, 169-209.
- REDDY, J. R. and EVANS, F. R. (1971). Morphology and life history of a new species of *Euplotes* from Great Salt Lake, Utah. *J. Protozool.*, **18** (Suppl.), 23.
- REED, S. A. (1971). Techniques for raising the planula larvae and newly settled polyps of *Pocillopora damicornis*. In H. M. Lenhoff, L. Muscatine and L. V. Davis (Eds), *Experimental Coelenterate Biology*. University of Hawaii Press, Honolulu. pp. 66-72.
- REES, G. H. (1959). Larval development of the sand crab *Emerita talpoida* (Sax) in the laboratory. *Biol. Bull. mar. biol. Lab., Woods Hole*, **117**, 356-370.
- REES, W. J. (1936). On a new species of hydroid, *Staurocoryne filiformis*, with a revision of the genus *Staurocoryne* ROTCH, 1872. *J. mar. biol. Ass. U.K.*, **21**, 134-142.
- REES, W. J. (1938). Observations on British and Norwegian hydroids and their medusae. *J. mar. biol. Ass. U.K.*, **23**, 1-42.
- REES, W. J. (1939). The hydroid of the medusa *Dipurena halterata* (FORBES). *J. mar. biol. Ass. U.K.*, **23**, 343-346.
- REES, W. J. (1941). Notes on British and Norwegian hydroids and medusae. *J. mar. biol. Ass. U.K.*, **25**, 129-141.
- REES, W. J. (1971). Paths and rates of food distribution in the colonial hydroid *Pennaria*. In H. M. Lenhoff, L. Muscatine and L. V. Davis (Eds), *Experimental Coelenterate Biology*. University of Hawaii Press, Honolulu. pp. 119-128.
- REES, W. J. and RUSSELL, F. S. (1937). On rearing the hydroids of certain medusae, with an account of the methods used. *J. mar. biol. Ass. U.K.*, **22**, 61-82.
- REESE, E. S. (1963). The behavioral mechanisms underlying shell selection by hermit crabs. *Behaviour*, **21**, 78-126.
- REEVE, M. R. (1969a). Growth, metamorphosis and energy conversion in the larvae of the prawn, *Palaemon serratus*. *J. mar. biol. Ass. U.K.*, **49**, 77-96.
- REEVE, M. R. (1969b). The laboratory culture of the prawn *Palaemon serratus*. *Fishery Invest., Lond.*, **26**, 1-38.

- REEVE, M. R. (1969c). The suitability of the English prawn *Palaemon serratus* (PENNANT) for cultivation—a preliminary assessment. *F.A.O. Fish. Rep.*, **57**, 1067–1073.
- REGNAULT, M. (1970). Croissance au laboratoire de *Crangon septemspinosa* SAY (Crustacea, Decapoda, Natantia), de la métamorphose à la maturité sexuelle. *Bull. Mus. natn. Hist. nat., Paris*, **42**, 1108–1126.
- REICH, K. (1935). The cultivation of a sterile amoeba on media without solid food. *J. exp. Zool.*, **69**, 497–500.
- REICH, K. (1936). Studies on the physiology of Amoebae. 1. The relation between nutrient solution, zone of growth and density of population. *Physiol. Zool.*, **9**, 254–263.
- REICHENBACH-KLINKE, H.-H. and OLLENSCHLÄGER, B. (1972). Medikament-Spätschäden bei Fischen. *Z. Wass. Abwass. Forsch.*, **3**, 84–90.
- REILLY, S. M. (1964). Importance of adsorbents in the nutrition of *Paramecium caudatum*. *J. Protozool.*, **11**, 109–113.
- REILLY, S. M., BALLWEG, R. F. and LILLY, D. M. (1962). A simplified medium for axenic cultures of *Paramecium*. *Am. Zool.*, **2**, 441.
- REIMER, A. (1971). Uptake and utilization of ¹⁴C-glycine by *Zoanthus* and its coelenteric bacteria. In H. M. Lenhoff, L. Muscatine and L. V. Davis (Eds), *Experimental Coelenterate Biology*. University of Hawaii Press, Honolulu. pp. 209–217.
- REINECK, M. (1962). The rearing of abandoned sucklings of *Phoca vitulina*. *Int. Zoo Yb.*, **4**, 293–294.
- REISH, D. J. (1953). Description of a new technique for rearing polychaetous annelids to sexual maturity. *Science, N.Y.*, **118**, 363–364.
- REISH, D. J. (1954). The life history and ecology of the polychaetous annelid *Nereis grubei* (KINBERG). *Occ. Pap. Allan Hancock Fdn.*, **14**, 1–75.
- REISH, D. J. (1955). The relation of polychaetous annelids to harbour pollution. *Publ. Hlth. Rep. Wash.*, **70**, 1168–1174.
- REISH, D. J. (1957a). Effects of pollution on marine life. *Ind. Wastes*, **2**, 114–118.
- REISH, D. J. (1957b). The relationship of the polychaetous annelid *Capitella capitata* FABRICIUS to waste discharges of biological origin. In C. M. Tarzwell (Ed.), *Biological Problems in Water Pollution*. Publ. Health Service, Washington. pp. 195–200.
- REISH, D. J. (1957c). The life history of the polychaetous annelid *Neanthes caudata* (DELLE CHIAJE), including a summary of development in the family Nereidae. *Pacif. Sci.*, **11**, 216–228.
- REISH, D. J. (1960). The use of marine invertebrates as indicators of water quality. In E. A. Pearson (Ed.), *Waste Disposal in the Marine Environment*. Pergamon Press, London. pp. 92–103.
- REISH, D. J. (1967). Relationship of polychaetes to varying dissolved oxygen concentrations. *Int. Conf. Wat. Pollut. Res. (Sect. 3)*, **3** (Paper 10), 1–10.
- REISH, D. J. (1970). A critical review of the use of marine invertebrates as indicators of varying degrees of marine pollution. *F.A.O. Techn. Conf. Mar. Poll. Effects on Living Resources and Fishing*, **1970**, 1–12.
- REISH, D. J. and BARNARD, J. L. (1960). Field toxicity tests in marine waters utilizing the polychaetous annelid *Capitella capitata* FABRICIUS. *Pacif. Nat.*, **1**, 1–8.
- REISINGER, E. (1957). Zur Entwicklungsgeschichte und Entwicklungsmechanik von *Craspedacusta* (Hydrozoa, Limnotrachilina). *Z. Morph. Ökol. Tiere*, **45**, 656–698.
- REISWIG, H. M. (1971a). Particle feeding in natural populations of three marine demosponges. *Biol. Bull. mar. biol. Lab., Woods Hole*, **141**, 568–591.
- REISWIG, H. M. (1971b). In situ pumping activities of tropical Demospongiae. *Mar. Biol.*, **9**, 38–50.
- REISWIG, H. M. (1973). Population dynamics of three Jamaican Demospongiae. *Bull. mar. Sci.*, **23**, 191–226.
- REISWIG, H. M. (1974). Water transport, respiration and energetics of three tropical marine sponges. *J. exp. mar. Biol. Ecol.*, **14**, 231–249.
- REITZENSTEIN, A. VON and EICHELBAUM, E. (1913). Das Seemoos und seine Fischerei an der Deutschen Küste. Teile I und II. *Abh. dt. SeefischVer.*, **12**, 1–94.
- REMANE, A. (1940). Einführung in die zoologische Ökologie der Nord- und Ostsee. In *Die Tierwelt der Nord- und Ostsee*, Vol. Ia. Grimpe & Wagler, Leipzig. pp. 1–238.

- RENÉ, F. (1974). Rearing of gilt-head *Sparus auratus*. In J. H. S. Blaxter (Ed.), *The Early Life History of Fish*. Springer-Verlag, Berlin. p. 747.
- RENFRO, W. C. and COOK, H. L. (1963). Early larval stages of the sea-bob *Xiphopeneus kroyeri* (HELLER). *Fishery Bull. Fish Wildl. Serv. U.S.*, **63**, 165-177.
- RENSBERGER, B. (1972). Lobsters grow faster in warm water. *The Evening Telegram (St. John's, Newfoundland)*, **94** (No. 224), 4.
- REVENTLOW, A. (1951). Observations on the walrus (*Odobenus rosmarus*) in captivity. *Zool. Gart., Frankf.*, **18**, 227-234.
- REYNOLD, G. S. (1968). *A Primer of Operant Conditioning*, Scott, Foresman, Glenview, Illinois.
- RHODES, E. W. and LANDERS, W. S. (1972). Growth of oyster larvae, *Crassostrea virginica*, of various sizes in different concentrations of the chrysophyte, *Isochrysis galbana*. *Proc. natn. Shellfish Ass.*, **63**, 53-59.
- RICE, A. L. and WILLIAMSON, D. I. (1970). Methods for rearing larval decapod Crustacea. *Helgoländer wiss. Meeresunters.*, **20**, 417-434.
- RICE, D. W. (1964). The Hawaiian monk seal. *Nat. Hist., N.Y.*, **73**, 48-55.
- RICHARDS, W. J. and PALKO, B. J. (1969). Methods used to rear the thread herring, *Opisthonema oglinum*, from fertilized eggs. *Trans. Am. Fish. Soc.*, **98**, 527-529.
- RICHMAN, S. and ROGERS, J. N. (1969). The feeding of *Calanus helgolandicus* on synchronously growing populations of the marine diatom *Ditylum brightwellii*. *Limnol. Oceanogr.*, **14**, 701-709.
- RICKETTS, E. F. and CALVIN, J. (1939). *Between Pacific Tides*, Stanford University Press, Stanford.
- RIDGWAY, S. H. (1966). Experiments on diving depth and duration in *Tursiops truncatus*. In *Proceedings of the 3rd Conference of Bio-Sonar and Diving Mammals*. Stanford Research Institute, Palo Alto, California. pp. 151-158.
- RIDGWAY, S. H. (Ed.) (1972a). *Mammals of the Sea*, C. C. Thomas, Springfield.
- RIDGWAY, S. H. (1972b). Homeostasis in the aquatic environment. In S. H. Ridgway (Ed.), *Mammals of the Sea*. C. C. Thomas, Springfield. pp. 590-747.
- RIGDON, R. H. and DRAGER, G. A. (1955). Thiamine deficiency in sea lions (*Otaria californianus*) fed only frozen fish. *J. Am. vet. med. Ass.*, **127**, 453-455.
- RILEY, J. D. (1966). Marine fish culture in Britain. VII. Plaice (*Pleuronectes platessa* L.) post-larval feeding on *Artemia salina* L. nauplii and the effects of varying feeding levels. *J. Cons. perm. int. Explor. Mer*, **30**, 204-221.
- RILEY, J. D., ROWE, R. J. and HIDU, H. (1972). Oysters: reattachment as method of rearing cultchless hatchery oysters. *Comm. Fish. Rev.*, **34**, 41-43.
- RILEY, J. D. and THACKER, G. T. (1969). New intergeneric cross within the Pleuronectidae, dab × flounder. *Nature, Lond.*, **221**, 484-486.
- ROBERTS, M. H., JR. (1970). Larval development of *Pagurus longicarpus* SAY reared in the laboratory. I. Description of larval instars. *Biol. Bull. mar. biol. Lab., Woods Hole*, **139**, 338-351.
- ROBERTS, M. H., JR. (1971a). Larval development of *Pagurus longicarpus* SAY reared in the laboratory. II. Effects of reduced salinity on larval development. *Biol. Bull. mar. biol. Lab., Woods Hole*, **140**, 104-116.
- ROBERTS, M. H., JR. (1971b). Larval development of *Pagurus longicarpus* SAY reared in the laboratory. III. Behavioral responses to salinity discontinuities. *Biol. Bull. mar. biol. Lab., Woods Hole*, **140**, 489-501.
- ROBERTS, M. H., JR. (1971c). Larval development of *Pagurus longicarpus* SAY reared in the laboratory. IV. Aspects of the ecology of the megalopa. *Biol. Bull. mar. biol. Lab., Woods Hole*, **141**, 162-166.
- ROBERTS, M. H., JR. (1974). Larval development of *Pagurus longicarpus* SAY reared in the laboratory. V. Effect of diet on survival and molting. *Biol. Bull. mar. biol. Lab., Woods Hole*, **146**, 67-77.
- ROBERTSON, P. B. (1968). The complete larval development of the sand lobster, *Scyllarus americanus* (SMITH), (Decapoda, Scyllaridae) in the laboratory, with notes on larvae from the plankton. *Bull. mar. Sci.*, **18**, 294-342.

- ROBERTSON, T. B. (1921). The influence of mutual contiguity upon reproduction rate and the part played therein by the 'x-factor' in bacterized infusions which stimulate the multiplication of infusoria. *Biochem. J.*, **15**, 1240-1247.
- ROBERTSON, T. B. (1924). Allelocatalytic effect in cultures of *Colpidium* in hay-infusion and in synthetic media. *Biochem. J.*, **18**, 612-619.
- ROCH, F. (1924). Experimentelle Untersuchungen an *Cordylophora caspia* (PALLAS) (=lacustris ALLMAN) über die Abhängigkeit ihrer geographischen Verbreitung und ihrer Wuchsform von den physikalisch-chemischen Bedingungen des umgebenden Mediums. *Z. Morph. Ökol. Tiere*, **2**, 350-426.
- RODENHOUSE, I. and GUBERLET, J. E. (1946). The morphology and behavior of the cushion star *Pteraster tesselatus*. *Univ. Wash. Publ. Biol.*, **12**, 21-48.
- ROELS, O. A. (in press). Growth of the European oyster, *Ostrea edulis* LINNÉ, in the St. Croix artificial upwelling mariculture system and in natural waters. In *Proceedings of the National Shellfish Association, 66th Joint Annual Meeting*.
- ROELS, O. A. and GERARD, R. D. (1970). Artificial upwelling. In H. W. Youngken (Ed.), *Food-drugs from the Sea Conference, 1969, University of Rhode Island. Marine Technology Society, Washington*. pp. 103-112.
- ROELS, O. A., HAINES, K. C. and SUNDERLIN, J. B. (in press). The potential yield of artificial upwelling mariculture. In G. Persoone and E. Jaspers (Eds), *Tenth European Marine Biology Symposium*. Ostend, Belgium, 1975.
- RÖTTGER, R. (1972a). Die Kultur von *Heterostegina depressa* (Foraminifera, Nummulitidae). *Mar. Biol.*, **15**, 150-159.
- RÖTTGER, R. (1972b). Die Bedeutung der Symbiose von *Heterostegina depressa* (Foraminifera, Nummulitidae) für hohe Siedlungsdichte und Karbonatproduktion. *Verh. Dtsch. Zool. Ges.*, **35**, 42-47.
- RÖTTGER, R. (1972c). Analyse von Wachstumskurven von *Heterostegina depressa* (Foraminifera, Nummulitidae). *Mar. Biol.*, **17**, 228-242.
- RÖTTGER, R. (1974). Larger Foraminifera: reproduction and early stages of development in *Heterostegina depressa*. *Mar. Biol.*, **26**, 5-12.
- RÖTTGER, R. and BERGER, W. H. (1972). Benthic Foraminifera: morphology and growth in clone cultures of *Heterostegina depressa*. *Mar. Biol.*, **15**, 89-94.
- ROLLEFFSEN, G. (1939). Artificial rearing of the fry of sea water fish. Preliminary communication. *Rapp. P.-v. Réun. Cons. int. Explor. Mer*, **109**, 1-133.
- ROMASHOV, D. D. and BELYAEVA, V. N. (1965). Increased yield of diploid gynogenetic loach larvae (*Misgurnus fossilis* L.) induced by temperature shock. (Russ.) *Byull. mosk. Obsch. Ispyt. Priv. (Biol. Ser.)*, **70**, 93-109.
- ROMASHOV, D. D., NIKOLYUKIN, N. I., BELYAEVA, V. N. and TIMOFEEVA, N. A. (1963). Possibilities of producing diploid radiation-induced gynogenesis in sturgeons. *Radiobiology*, **3**, 145-154.
- RONALD K. and MANSFIELD, A. W. (Eds) (1975). Biology of the seal. *Rapp. P.-v. Réun. Cons. int. Explor. Mer*, **169**, 1-557.
- ROOT, F. M. (1914). Reproduction and reactions to food in the suctorian *Podophrya collini* n. sp. *Arch. Protistenk.*, **35**, 164-196.
- ROSE, S. M. (1957). Polarized inhibitory effects during regeneration in *Tubularia*. *J. Morphol.*, **100**, 187-205.
- ROSE, S. M. (1959). Failure of survival of slowly growing members of a population. *Science*, **N. Y.**, **129**, 1026.
- ROSE, S. M. (1960). A feedback mechanism of growth control in tadpoles. *Ecology*, **41**, 188-199.
- ROSENTHAL, H. (1966). Beobachtungen über das Verhalten der Seezungenbrut. *Helgoländer wiss. Meeresunters.*, **13**, 213-228.
- ROSENTHAL, H. (1968a). Schwimmverhalten und Schwimmgeschwindigkeit bei den Larven des Herings *Clupea harengus*. *Helgoländer wiss. Meeresunters.*, **18**, 453-486.
- ROSENTHAL, H. (1968b). Beobachtungen über die Entwicklung des Schwarmverhaltens bei den Larven des Herings *Clupea harengus*. *Mar. Biol.*, **2**, 73-76.
- ROSENTHAL, H. (1969a). Untersuchungen über das Beutefangverhalten bei Larven des Herings *Clupea harengus*. *Mar. Biol.*, **3**, 208-221.

- ROSENTHAL, H. (1969b). Verdauungsgeschwindigkeit, Nahrungswahl und Nahrungsbedarf bei den Larven des Herings *Clupea harengus* L. *Ber. dt. wiss. Komm. Meeresforsch.*, **20**, 60-96.
- ROSENTHAL, H. and ALDERDICE, D. F. (1976). Sublethal effects of environmental stressors, natural and pollutional, on marine fish eggs and larvae. *J. Fish. Res. Bd Can.*, **33**, 2047-2065.
- ROSENTHAL, H. and FONDS, M. (1973). Biological observations during rearing experiments with the garfish *Belone belone*. *Mar. Biol.*, **21**, 203-218.
- ROSENTHAL, H. and HEMPEL, G. (1970). Experimental studies in feeding and food requirements of herring larvae (*Clupea harengus* L.). In J. H. Steele (Ed.), *Marine Food Chains*. Oliver & Boyd, Edinburgh. pp. 344-364.
- ROSENTHAL, H. and PAFFENHÖFER, G.-A. (1972). On the digestion rate and calorific content of food and feces in young garfish. *Naturwissenschaften*, **59**, 274-275.
- ROSENTHAL, H. and SPERLING, K.-R. (1974). Effects of cadmium on development and survival of herring eggs. In J. H. S. Blaxter (Ed.), *The Early Life History of Fish*. Springer-Verlag, Berlin. pp. 383-396.
- ROSS, C. A. (1972). Biology and ecology of *Marginopora vertebralis* (Foraminiferida), Great Barrier Reef. *J. Protozool.*, **19**, 181-192.
- ROTH, J. S. (1963). Partial purification and some properties of a ribonuclease from *Tetrahymena pyriformis* W. *J. Protozool.*, **10** (Suppl.), 24.
- ROTRAMEL, G. (1975). Filter-feeding by the marine boring isopod *Sphaeroma quoyanum* H. MILNE EDWARDS, 1840 (Isopoda, Sphaeromatidae). *Crustaceana*, **28**, 7-10.
- RUBINOFF, I. (1958). Raising the atherinid fish, *Menidia menidia*, in the laboratory. *Copeia*, **2**, 146-147.
- RUDZINSKA, M. A. (1951). The influence of amount of food on the reproduction rate and longevity of a suctorian (*Tokophrya infusorium*). *Science, N.Y.*, **113**, 10-11.
- RUE, G. R. LA (1937). Tubificidae. In J. G. Needham (Ed.), *Culture Methods for Invertebrate Animals*. Comstock Publishing Co., New York. pp. 194-195.
- RULLIER, F. (1955). Développement du serpulien *Mercierella enigmata* FAUVEL. *Vie et Milieu*, **6**, 225-240.
- RUMIANZEFF, A. (1923). Zur Frage über den Einfluß der aktuellen Bakterien des Mediums auf die Geschlechtsbestimmung bei *Brachionus urceolaris*. (Quoted from HALBACH and HALBACH-KEUP, 1972.)
- RUNNELS, R. A. (1954). *Animal Pathology*, Iowa State College Press, Ames.
- RUNNSTRÖM, J. (1933). Züchtung der Echinodermen. In E. Aberhalden (Ed.), *Handbuch der biologischen Arbeitsmethoden*, Abtlg. 9, Teil 5, Bd 1. Urban & Schwarzenberg, Berlin. pp. 404-442.
- RUNNSTRÖM, J. and IMMERS, J. (1971). Treatment with lithium as a tool for the study of animal-vegetal interactions in sea urchin embryos. *Wilhelm Roux Arch. EntwMech. Org.*, **167**, 222-242.
- RUNNSTRÖM, J. and KRISZAT, G. (1950). Action of periodate on the surface reactions attending the activation of the egg of the sea urchin, *Psammechinus miliaris*. *Expl Cell Res.*, **1**, 355-370.
- RUNNSTRÖM, J., NUZZOLO, C. and CITRO, G. (1972). Ribosomes and polyribosomes in sea urchin development, particularly in embryos undergoing animalization or vegetalization. *Expl Cell Res.*, **72**, 252-256.
- RUSSELL, F. S. (1936). On the first stage of the medusa *Echeilota clausa* (HINCKS) (= *E. hartlanubi* RUSSELL). *J. mar. biol. Ass. U.K.*, **21**, 131-133.
- RUSSELL, F. S. (1970). *The Medusae of the British Isles*, Volume II, Pelagic Scyphozoa, with a supplement to the first volume on Hydromedusae, Cambridge University Press, London.
- RUSSELL, F. S. and REES, W. J. (1936). On rearing the hydroid *Zanclaea implexa* (ALDER) and its medusa *Zanclaea gemmosa* McCRADY, with a review of the genus *Zanclaea*. *J. mar. biol. Ass. U.K.*, **21**, 107-130.
- RUTHERFORD, C. L., HESSINGER, D. and LENHOFF, H. M. (1965). Induction of rhythmic differentiation of ovaries in *Chlorohydra viridissima*. *Am. Zool.*, **5**, 722.
- RUTHERFORD, J. C. (1973). Reproduction, growth and mortality of the holothurian *Cucumaria pseudoaurata*. *Mar. Biol.*, **22**, 167-176.

- RUTHVEN, J. A. and CAIRNS, J., JR. (1973). Response of fresh-water protozoan artificial communities to metals. *J. Protozool.*, **20**, 127-135.
- RYAN, E. P. (1966). Pheromone: evidence in a decapod crustacean. *Science, N.Y.*, **151**, 340-341.
- RYDER, J. A. (1883). Rearing oysters from artificially fertilized eggs, together with notes on pond culture, etc. *Bull. U.S. Fish Commn.*, **3**, 281-294.
- RYLAND, J. S. (1959). Experiments on the selection of algal substrates by polyzoan larvae. *J. exp. Biol.*, **36**, 613-631.
- RYLAND, J. S. (1962). The association between Polyzoa and algal substrata. *J. anim. Ecol.*, **31**, 331-338.
- RYLAND, J. S. and STEBBING, A. R. D. (1971). Settlement and orientated growth in epiphytic and epizoid bryozoans. In D. J. Crisp (Ed.), *Fourth European Marine Biology Symposium*. Cambridge University Press, London. pp. 105-123.
- SABAUT, J. J. and LUQUET, P. (1973). Nutritional requirements of the gilthead bream *Chryso-phrys aurata*. Quantitative protein requirements. *Mar. Biol.*, **18**, 50-54.
- SADYKHOVA, I. A. (1973). The cultivation and some biological characteristics of bivalve molluscs. (Russ.) *Itogi Nauki i Tekh. Zool. Bespozvonochnykh*, **2**, 102-154.
- SAGARA, J. (1958a). Artificial discharge of reproductive elements of certain bivalves caused by treatment of sea water and by injection with NH₄OH. (Jap.; Engl. abstract.) *Bull. Jap. Soc. scient. Fish.*, **23**, 505-510.
- SAGARA, J. (1958b). On the optimum temperature and salinity for the development of hard clam, *Meretrix meretrix lusoria* (RÖDING). *Bull. Tokai reg. Fish. Res. Lab.*, **22**, 27-32.
- SAISHO, T. (1966a). Studies on the phyllosoma larvae with reference to the oceanographical conditions. *Mem. Fac. Fish. Kagoshima Univ.*, **15**, 177-239.
- SAISHO, T. (1966b). A note on the phyllosoma stages of spiny lobster. *Inf. Bull. Planktol. Japan*, **13**, 69-71.
- SAKSENA, V. P. and HOUDE, E. D. (1972). Effect of food level on the growth and survival of laboratory-reared larvae of bay anchovy (*Anchoa mitchilli* VALENCIENNES) and scaled sardine (*Harengula pensacolae* GOODE and BEAN). *J. exp. mar. Biol. Ecol.*, **8**, 249-258.
- SALVINI-PLAWEN, L. V. (1972). Cnidaria as food-sources for marine invertebrates. *Cah. Biol. mar.*, **13**, 385-400.
- SAMAIN, J. F. and BOUCHER, J. (in press). Signification biologique des activités des enzymes digestives et des teneurs protéiques d'*Artemia salina*—aspects d'application à l'étude de la nutrition. In G. Persoone and E. Jaspers (Eds), *Tenth European Marine Biology Symposium*. Ostend, Belgium, 1975.
- SAMUELSEN, T. J. (1972). Larvae of *Pagurus variabilis* MILNE-EDWARDS & BOUVIER (Decapoda, Anomura) reared in the laboratory. *Sarsia*, **48**, 1-11.
- SANDERS, H. L., GOUDSMIT, E. M., MILLS, E. L. and HAMPSON, G. E. (1962). A study of the intertidal fauna of Barnstable harbor, Massachusetts. *Limnol. Oceanogr.*, **7**, 63-79.
- SANDIFER, P. A. (1973). Effects of temperature and salinity on larval development of grass shrimp, *Palaemonetes vulgaris* (Decapoda, Caridea). *Fish. Bull. natn. oceanic Atmos. Adm.*, **71**, 115-121.
- SANDISON, E. E. (1954). The identification of the nauplii of some South African barnacles with notes on their life histories. *Trans. R. Soc. S. Afr.*, **34**, 69-101.
- SAROJINI, K. K. (1954). The food and feeding habits of the grey mullets, *Mugil parsia* HAMILTON and *M. speigleri* BLEEKER. *Indian J. Fish.*, **1**, 67-93.
- SARS, M. (1844). Über die Entwicklung der Seesterne. Fragment aus meinen Beiträgen zur Fauna von Norwegen. *Arch. Naturgesch.*, **10**, 169-178.
- SARS, M. (1846). Beschreibung und Abbildungen neuer oder wenig bekannter Seethiere, nebst Beobachtungen über die Organisation, Lebensweise und Entwicklung derselben. *Fauna littoralis Norvegiae*, **1**, 1-731.
- SARS, M. (1857). Bidrag til Kundskaben om Middelhavets Littoral-Fauna, Rejsebemaerkninger fra Italien. *Nyt. Mag. Naturvid.*, **9**, 57-155.
- SASSER, J. N. and JENKINS, W. R. (Eds) (1960). *Nematology*, University of North Carolina Press, Chapel Hill.
- SASTRY, A. N. (1970a). Culture of brachyuran crab larvae using a recirculating sea water system in the laboratory. *Helgoländer wiss. Meeresunters.*, **20**, 406-416.

- SASTRY, A. N. (1970b). Environmental regulation of oocyte growth in the bay scallop *Aequipecten irradians* LAMARCK. *Experientia*, **26**, 1371-1372.
- SATIA, B. P. (1974). Quantitative protein requirements of rainbow trout. *Progve Fish Cult.*, **36**, 80-85.
- SATO, S. (1958). Studies on larval development and fishery biology of king crab, *Paralithodes camtschatica* (TILESIUS). *Bull. Hokkaido reg. Fish. Res. Lab.*, **17**, 1-102.
- SATO, T. (1967). *Oyster culture, Aquaculture* (Jap.), Koseisha-Koseikaku, Tokyo.
- SAWAYA, P. (1962). On a bioassay for acetylcholine and on some properties of the longitudinal muscles of *Holothuria grisea* (Echinodermata). *Bolm Fac. Filos. Ciênc. Univ. S Paulo (Zool.)*, **24**, 5-10.
- SAWAYA, P. and ANCONA LOPEZ, A. A. (1959). Sôbre a fisiologia dos músculos longitudinais de *Holothuria grisea*. *Bolm Fac. Filos. Ciênc. Univ. S Paulo (Zool.)*, **22**, 75-97.
- SAWYER, T. K. (1971). *Acanthamoeba griffini*, a new species of marine amoeba. *J. Protozool.*, **18**, 650-654.
- SAZHINA, L. I. (1968a). A method for keeping marine pelagic Copepoda in the laboratory. (Russ.; Engl. summary.) *Zool. Zh.*, **47**, 1713-1716.
- SAZHINA, L. I. (1968b). On hibernating eggs of marine Calanoida. *Zool. Zh.*, **47**, 1554-1556.
- SCARRATT, D. J. and RAINE, G. E. (1967). Avoidance of low salinity by newly hatched lobster larvae. *J. Fish. Res. Bd Can.*, **24**, 1403-1406.
- SCHACH, H. (1939). Die künstliche Aufzucht von *Clupea harengus* L. *Helgoländer wiss. Meeresunters.*, **1**, 359-372.
- SCHÄPERCLAUS, W. (1933). Textbook of pond culture. *Fishery Leaf. Fish Wildl. Serv. U.S.*, **31**.
- SCHÄPERCLAUS, W. (1954). *Fischkrankheiten*, Akademie Verlag, Berlin.
- SCHÄPERCLAUS, W. (1961). Einfluß der Injektionen oder Verfütterung antibiotischer Mittel auf das Wachstum von Karpfen. *Z. Fisch.*, **10**, 549.
- SCHAEFFER, T. H. and SPERRY, C. C. (1931). Food habits of the Pacific harbor seal (*Phoca richardi*). *J. Mammal.*, **12**, 214-226.
- SCHAEFFER, V. B. (1958). *Seals, Sea Lions, and Walruses*, Stanford University Press, California.
- SCHAEFFER, V. B. and NEFF, J. A. (1948). Food of California sea lions. *J. Mammal.*, **29**, 67-68.
- SCHAEFFER, V. B. and SLIPP, J. W. (1944). The harbor seal in Washington State. *Am. Midl. Nat.*, **32**, 373-416.
- SHELTEMA, A. H. (1969). Pelagic larvae of New England gastropods. IV. *Anachis translirata* and *Anachis avara* (Columbellidae, Prosobranchia). *Vie Milieu (Ser. A)*, **20**, 94-104.
- SHELTEMA, R. S. (1961). Metamorphosis of the veliger larvae of *Nassarius obsoletus* (Gastropoda) in response to bottom sediment. *Biol. Bull. mar. biol. Lab., Woods Hole*, **120**, 92-109.
- SHELTEMA, R. S. (1962). Pelagic larvae of New England intertidal gastropods. I. *Nassarius obsoletus* SAY and *Nassarius vibex* SAY. *Trans. Am. microsc. Soc.*, **81**, 1-11.
- SHELTEMA, R. S. (1965). The relationship of salinity to larval survival and development in *Nassarius obsoletus* (Gastropoda). *Biol. Bull. mar. biol. Lab., Woods Hole*, **129**, 340-354.
- SHELTEMA, R. S. (1967). The relationship of temperature to the larval development of *Nassarius obsoletus* (Gastropoda). *Biol. Bull. mar. biol. Lab., Woods Hole*, **132**, 253-265.
- SHELTEMA, R. S. and SHELTEMA, A. H. (1963). Pelagic larvae of New England intertidal gastropods. II. *Anachis avara*. *Hydrobiologia*, **22**, 85-91.
- SHELTEMA, R. S. and SHELTEMA, A. H. (1965). Pelagic larvae of New England intertidal gastropods. III. *Nassarius trivittatus*. *Hydrobiologia*, **25**, 321-329.
- SCHIMMEL, S. C. and HANSEN, D. J. (1975). An automatic brine shrimp feeder for aquatic bioassays. *J. Fish. Res. Bd Can.*, **32**, 314-316.
- SCHLIEFER, C. (Ed.) (1968). *Methoden der meeresbiologischen Forschung*, VEB Gustav Fischer Verlag, Jena.
- SCHMIDT, O. (1863). Auszug aus dem Berichte des Professor Dr. O. Schmidt über die im Auftrage der Triester Handels- und Gewerbekammer in Dalmatien angestellten Versuche über die künstliche Schwammzucht. *Z. Akklimatisation*, **1**, 290-295.
- SCHMITT, W. L. (1910). *Crustaceans*. In: Smithsonian Series. Series Publishers, New York. pp. 96-248.
- SCHMOLLER, H. (1965). Die Anreicherung von Kulturamöben mit dem Ziel ihrer partikelfreien Ernährung. *Zentbl. Bakt. ParasitKde*, **1** (Suppl.), 117-122.

- SCHMOLLER, H. and SCHWARZ, W. (1964). Untersuchungen über die Nahrungsansprüche einiger mariner Amöben. *Z. allg. Mikrobiol.*, **4**, 313-325.
- SCHNEIDER, D. (1955). Phototropisches Wachstum der Zoide und Rhizoide von *Bugula avicularia*. *Naturwissenschaften*, **42**, 48-49.
- SCHNEIDER, D. (1959). Der Aufbau der *Bugula*-Tierstöcke und seine Beeinflussung durch Aussenfaktoren. *Biol. Zbl.*, **78**, 250-283.
- SCHNEIDER, D. (1963). Normal and phototropic growth reactions in the marine bryozoan *Bugula avicularia*. In E. C. Dougherty (Ed.), *The Lower Metazoa*. University of California Press, pp. 357-371.
- SCHNEIDER, T. and ZAHRADNIK, J. W. (1974). *An Approach to the Aquaculture of Lobsters*, University of Massachusetts, Aquacultural Engineering Laboratory, Wareham, Publ., **008-6-74**.
- SCHÖNE, C. (1971). Über den Einfluß von Nahrung und Substratsalinität auf Verhalten, Fortpflanzung und Wasserhaushalt von *Enchytraeus albidus* HENLE (Oligochaeta). *Oecologia (Berl.)*, **6**, 254-266.
- SCHÖNE, H. (1961). Complex behavior. In T. H. Waterman (Ed.), *The Physiology of Crustacea*, Vol. II. Academic Press, New York, pp. 465-520.
- SCHÖNE, H. (1974). *Orientierung im Raum*, Wissenschaftliche Verlags-Gesellschaft, Stuttgart.
- SCHÖNE, H. (1975). Orientation in space: Animals. General introduction. In O. Kinne (Ed.), *Marine Ecology*, Vol. II, Physiological Mechanisms, Part 2. Wiley, London, pp. 499-553.
- SCHOENER, A. (1971). On the importance of pelagic species of copepods to the diet of some benthic invertebrates (Ophiuroidea). *Crustaceana*, **21**, 153-160.
- SCHOENER, T. W. (1971). Theory of feeding strategies. *Annual Review of Ecology and Systematics*, **2**, 369-404.
- SCHOLANDER, P. F., IRVING, L. and GRINNELL, S. W. (1942). On the temperature and metabolism of the seal during diving. *J. cell. comp. Physiol.*, **19**, 67-78.
- SCHOLANDER, P. F. and SCHEVILL, W. E. (1955). Counter-current vascular heat exchange in the fins of whales. *J. appl. Physiol.*, **8**, 279-292.
- SCHOLANDER, P. F., WALTERS, V., HOCK, R. and IRVING, L. (1950). Body insulation of some arctic and tropical mammals and birds. *Biol. Bull. mar. biol. Lab., Woods Hole*, **99**, 225-236.
- SCHOLZ, A. J. (1973). Preliminary evaluation of oyster seed holding-trays. *Proc. natn. Shellfish. Ass.*, **63**, 10.
- SCHROEDER, C. R. and WEDGEFORTH, H. M. (1935). The occurrence of gastric ulcers in sea mammals of the California coast, their aetiology and pathology. *J. Am. vet. med. Ass.*, **87**, 333-342.
- SCHRÖDER, G. (1886). *Anatomisch-histologische Untersuchung von Nereis diversicolor* O. FR. MÜLL. Inaugural-Dissertation Kiel, Rathenow.
- SCHULTE, E. H. (in press). The laboratory culture of the palaemonid shrimp *Leander squilla*. In G. Persoone and E. Jaspers (Eds), *Tenth European Marine Biology Symposium*. Ostend, Belgium, 1975.
- SCHULZ, D. (1975). Salinitätspräferenzen bei Glasaalen und jungen Gelbaalen (*Anguilla anguilla*). *Helgoländer wiss. Meeresunters.*, **27**, 199-210.
- SCHULZ, W. (1916). Zur Biologie von *Enchytraeus albidus* HENLE, I. Ökologie. *Z. wiss. Zool.*, **158**, 31-78.
- SCHULZE, F. E. (1878). Untersuchungen über den Bau und die Entwicklung der Spongien. *Z. wiss. Zool.*, **31**, 262-295.
- SCHUSTER, W. H. (1960). Synopsis of biological data on milkfish *Chanos chanos* (FORSKÅL) 1775. *F.A.O. Fish. Synopses*, **4**, 1-65.
- SCHUUR, A. M., ALLEN, P. G. and BOTSFORD, L. W. (1974). An analysis of three facilities for the commercial production of *Homarus americanus*. *Am. Soc. Agricultural Engineers., St. Joseph, Michigan. Paper 74-5617*.
- SCHUURMANS STEKHOVEN, J. H. (1933). Die Nahrung von *Oncholaimus dujardini* DE MAN. *Zool. Anz.*, **101**, 167-168.
- SCHWARZ, S. (1963). Produktionsbiologische Untersuchungen am Zooplankton der

- Rügenschen, Hiddenseer und Darßer Boddengewässer (1953-1955). *Z. Fisch.*, **11**, 641-672.
- SEELEMANN, U. (1967). Rearing experiments on the amphibian slug *Alderia modesta*. *Helgoländer wiss. Meeresunters.*, **15**, 128-134.
- SEGAL, E. (1970). Light: Animals—Invertebrates. In O. Kinne (Ed.), *Marine Ecology*, Vol. I, Environmental Factors, Part 1. Wiley, London. pp. 159-211.
- SE GROVE, F. (1941). The development of the serpulid *Pomatoceros triqueter* L. Q. *Jl microsc. Sci.*, **82**, 467-540.
- SEILACHER, A. (1951). Der Röhrenbau von *Lanice conchilega* (Polychaeta). Ein Beitrag zur Deutung fossiler Lebensspuren. *Senckenbergiana*, **32**, 267-280.
- SELTZ, J. (1974). Attempt at young eel rearing in a closed circulation system. Growth test. *Mem. CTGREF, Bordeaux*, **3**, 1-51.
- SEN, P. R. and CHATTERJEE, D. K. (1976). Enhancing production of Indian major carp fry and fingerlings by use of growth promoting substances. *FAO Technical Conference on Aquaculture*. Kyoto, Japan. FIR:AQ/Conf./76/E.66, 1-12.
- SENTZ-BRACONNOT, E. (1964). Sur le développement des serpulidæ *Hydroïdes norvegica* (GUNNERUS) et *Serpula concharum* LANGERHANS. *Cah. Biol. mar.*, **5**, 385-389.
- SERFLING, S. A., OLST, J. C. VAN and FORD, R. F. (1974a). A recirculating culture system for larvae of the American lobster, *Homarus americanus*. *Aquaculture*, **3**, 303-309.
- SERFLING, S. A., OLST, J. C. VAN and FORD, R. F. (1974b). An automatic feeding device and the use of live and frozen *Artemia* for culturing larval stages of the American lobster, *Homarus americanus*. *Aquaculture*, **3**, 311-314.
- SERGEANT, D. E. (1962). The biology of the pilot or pothead whale *Globicephala melaena* (TRAILL) in Newfoundland waters. *Bull. Fish. Res. Bd Can.*, **132**, 32-67.
- SERGEANT, D. E. (1966). Reproductive rates of harp seals, *Pagophilus groenlandicus* (ERXLEBEN). *J. Fish. Res. Bd Can.*, **23**, 757-766.
- SERGEANT, D. E. (1969). Feeding rates of Cetacea. *Fisk Dir. Skr. Ser. Havundersøkelser*, **15**, 246-258.
- SETOGUCHI, I. (1957). Basic studies on the propagation of *Pteria macroptera* (I). (Jap.) *Kagoshima Fish. exp. Sta.*, **1956**, 1-33.
- SETOGUCHI, I. (1958). Basic studies on the propagation of *Pteria macroptera* (II). (Jap.) *Kagoshima Fish. exp. Sta.*, **1957**, 1-259.
- SETOGUCHI, I. (1959). On the artificial fertilization and early development of *Pinctada margaritifera*. (Jap.) *Kagoshima Fish. exp. Sta.*, **1959**, 1-137.
- SETTE, O. E. (1943). Biology of the Atlantic mackerel (*Scomber scombrus*) of North America. Part I: Early life history, including the growth drift and mortality of the egg and larval populations. *Fishery Bull. Fish Wildl. Serv. U.S.*, **50**, 149-237.
- SUGUROS, P. L., MEYERS, S. P. and SIMMS, J. (1962). Role of marine fungi in the biochemistry of the oceans. I. Establishment of quantitative technique for the cultivation, growth measurement and production of inocula. *Mycologia*, **54**, 521-535.
- SHAPIRO, H. (1935). The validity of the centrifug⁸ method for estimating aggregate cell volume in suspensions of the egg of the sea urchin, *Arbacia punctulata*. *Biol. Bull. mar. biol. Lab., Woods Hole*, **68**, 363, 377.
- SHAW, E. (1962). The schooling of fishes. *Scient. Am.*, **206**, 128-138.
- SHAW, E. (1967). Some new thoughts on the schooling of fishes. *FAO Conf. Fish Behavior, Bergen*, ER:FB (67) R-11.
- SHAW, E. and SACHS, B. D. (1967). Development of the optomotor response in the schooling fish, *Menidia menidia*. *J. comp. physiol. Psychol.*, **63**, 385-388.
- SHAW, H. M., SAUNDERS, R. L., HALL, H. C. and HENDERSON, E. B. (1975a). Effect of dietary sodium chloride on growth of Atlantic salmon (*Salmo salar*). *J. Fish. Res. Bd Can.*, **32**, 1813-1819.
- SHAW, H. M., SAUNDERS, R. L. and HALL, H. C. (1975b). Environmental salinity: its failure to influence growth of Atlantic salmon (*Salmo salar*) PARR. *J. Fish. Res. Bd Can.*, **32**, 1821-1824.
- SHEARER, C. (1912). The problem of sex determination in *Dinophilus gyrociliatus*. I. The sexual cycle. *Q. Jl microsc. Sci.*, **57**, 329-371.
- SHEHADEH, Z. H. (1972). Controlled breeding of culturable species of fish. A review of progress

- and current problems. In T. V. R. Pillay (Ed.), *Coastal Aquaculture in the Indo-Pacific Region*. Fishing News (Books) Ltd., Surrey. pp. 180-194.
- SHEHADEH, Z. H. (1973). Induced breeding techniques. A review of progress and problems. *FAO, EIFAC Workshop on Controlled Reproduction of Cultivated Fishes*. Hamburg.
- SHEHADEH, Z. H., CHING-MING, K. and NASH, C. F. (1973d). Establishing brood stock of grey mullet (*Mugil cephalus* L.) in small ponds. *Aquaculture*, **2**, 379-384.
- SHEHADEH, Z. H. and ELLIS, J. N. (1970). Induced spawning of the striped mullet *Mugil cephalus* L. *J. Fish Biol.*, **2**, 355-360.
- SHEHADEH, Z. H., KUO, C.-M. and MILISEN, K. K. (1973a). Induced spawning of grey mullet *Mugil cephalus* L. with fractional salmon pituitary extract. *J. Fish Biol.*, **5**, 471-478.
- SHEHADEH, Z. H., KUO, C.-M. and MILISEN, K. K. (1973b). Validation of an *in vivo* method for monitoring ovarian development in the grey mullet (*Mugil cephalus* L.). *J. Fish Biol.*, **5**, 489-496.
- SHEHADEH, Z. H., MADDEN, W. D. and DOHL, T. P. (1973c). The effect of exogenous hormone treatment on spermiation and vitellogenesis in the grey mullet, *Mugil cephalus* L. *J. Fish Biol.*, **5**, 479-487.
- SHELBOURNE, J. E. (1953). The feeding habits of plaice post-larvae in the Southern Bight. *J. mar. biol. Ass. U.K.*, **32**, 149-159.
- SHELBOURNE, J. E. (1962). A predator-prey size relationship for plaice larvae feeding on *Oikopleura*. *J. mar. biol. Ass. U.K.*, **42**, 243-252.
- SHELBOURNE, J. E. (1963). A marine fish-rearing experiment using antibiotics. *Nature, Lond.*, **198**, 74-75.
- SHELBOURNE, J. E. (1964). The artificial propagation of marine fish. *Adv. mar. Biol.*, **2**, 1-83.
- SHELBOURNE, J. E. (1969). In J. D. Costlow, JR. (Ed.), *Marine Biology, V, Proceedings of the Fifth Interdisciplinary Conference on Marine Biology*. Gordon and Breach, New York.
- SHELBOURNE, J. E., RILEY, J. D. and THACKER, G. T. (1963). Marine fish culture in Britain. I. Plaice rearing in closed circulation at Lowestoft, 1957-1960. *J. Cons. int. Explor. Mer*, **28**, 50-69.
- SHELL, E. W. (1967). Monosex culture of male *Tilapia nilotica* in ponds stocked at three rates. *F.A.O. Fish. Rep.*, **44**, 354-356.
- SHEN, C. J. (1939). The larval development of some Peiping Caridea—the Caridina (Atyidae), the Palaemonetes and the Palaemon (Palaemonidae). *40th Anniv. Pap. Nat. Univ. Peking*, **1**, 169-201.
- SHEN, T. H. (1936). Beiträge zum Studium der Geschlechtsbestimmung bei *Dinophilus apatris*. *Zool. Jb. (Allg. Zool. Physiol. Tiere)*, **56**, 219-238.
- SHIFRINE, M., OUSTERHOUT, L. E., GRAW, C. R. and VAUGHN, R. H. (1959). Toxicity to chicks of histamine formed during microbial spoilage of tuna. *Appl. Microbiol.*, **7**, 45-50.
- SHIGUENO, K. (1970). *Problems of Prawn Culture in Japan*, Oversea Technical Cooperation Agency, Tokyo.
- SHIMAYA, M., KANAZAWA, A. and KASHIWADA, K.-I. (1967). Studies on the utilization of marine yeast. I. Culture of *Artemia* and *Daphnia* by marine yeast. (Jap.; Engl. summary.) *Mem. Fac. Fish. Kagoshima Univ.*, **16**, 34-39.
- SHIRAIISHI, K. (1966). Bacteria-free culture and nutrition of microcrustacea. (Jap.; Engl. abstract.) *Inf. Bull. Planktol. Japan*, **13**, 49-54.
- SHIRAIISHI, K. and PROVASOLI, L. (1959). Growth factors as supplements to inadequate algal foods for *Tigriopus japonicus*. *Tohoku J. Agr. Res.*, **10**, 89-96.
- SHIRAIISHI, Y. (1965a). The influence of photoperiodicity on the maturation of ayu-fish, *Plecoglossus altivelis*. IV. The effect of wave length and of conversion of darkness and light on the maturation. *Bull. Freshwat. Fish. Res. Lab., Tokyo*, **15**, 77-84.
- SHIRAIISHI, Y. (1965b). The influence of photoperiodicity on the maturation of ayu-fish, *Plecoglossus altivelis*. V. The effect of removal of eye on the maturation. *Bull. Freshwat. Fish. Res. Lab., Tokyo*, **15**, 85-90.
- SHIRAIISHI, Y. and FUKUDA, Y. (1966). The relation between the day length and the maturation in four species of salmonid fish. *Bull. Freshwat. Fish. Res. Lab., Tokyo*, **16**, 103-111.
- SHELESER, R. A. (in press). Development of crustacean aquaculture. In G. Persoone and E. Jaspers (Eds), *Tenth European Marine Biology Symposium*. Ostend, Belgium, 1975.

- SELESER, R. A. (in press). An interdisciplinary approach to the development of decapod mariculture. In G. Persoone and E. Jaspers (Eds), *Tenth European Marine Biology Symposium*. Ostend, Belgium, 1975.
- SHOKITA, S. (1970). Studies on the multiplication of the fresh water prawn *Macrobrachium formosense* BATE. I. The larval development reared in the laboratory. (Jap.; Engl. summary.) *Biol. Mag. Okinawa*, **6**, 1-12.
- SHUDO, K., NAKAMURA, K., ISHIKAWA, S. and KITABAYASHI, K. (1971). Studies on formula feed for Kuruma prawn. IV. On the growth-promoting effects of both squid liver oil and cholesterol. (Jap.; Engl. abstract.) *Bull. Tokai reg. Fish. Res. Lab.*, **65**, 129-137.
- SHULL, A. F. (1910a). The artificial production of the parthenogenetic and sexual phases of the life cycle of *Hydatina senta*. *Am. Nat.*, **44**, 146-150.
- SHULL, A. F. (1910b). Studies in the life cycle of *Hydatina senta*. I. *J. exp. Zool.*, **8**, 311-354.
- SHULL, A. F. (1911). Studies in the life cycle of *Hydatina senta*. II. *J. exp. Zool.*, **10**, 117-166.
- SHULL, A. F. (1915). Periodicity in the production of males in *Hydatina senta*. *Biol. Bull. mar. biol. Lab., Woods Hole*, **28**, 187-197.
- SHULL, A. F. (1929). Determination of types of individuals in aphids, rotifers and Cladocera. *Biol. Rev.*, **4**, 218-248.
- SICK, L. V. (1976). Nutritional effect of five species of marine algae on the growth, development, and survival of the brine shrimp *Artemia salina*. *Mar. Biol.*, **35**, 69-78.
- SICK, L. V., ANDREWS, J. W. and WHITE, D. B. (1972). Preliminary studies of selected environmental and nutritional requirements for the culture of penaeid shrimp. *Fish. Bull. U.S.*, **70**, 101-109.
- SICK, L. V., WHITE, D. and BAPTIST, G. (1973). The effect of duration of feeding, amount of food, light intensity, and animal size on rate of ingestion of pelleted food by juvenile penaeid shrimp. *Proeve Fish Cult.*, **35**, 22-26.
- SIMPSON, A. C., HOWELL, B. R. and WARREN, P. J. (1970). Synopsis of biological data on the shrimp *Pandalus montagui* LEACH, 1814. *F.A.O. Fish. Rep.*, **57**, 1225-1249.
- SIMPSON, J. G. and LEATHERWOOD, J. S. (1970). Development and testing of prepared ration for porpoises, seals and sea lions. *NUC Technical Report*. (Quoted in RIDGWAY, 1972b.)
- SIMPSON, J. J. and BROWN, R. N. R. (1910). Asteroidea of Portuguese East Africa, collected by J. J. Simpson. *Proc. R. phys. Soc. Edinb.*, **17**, 45-60.
- SIMPSON, T. L. (1963). The biology of the marine sponge *Microciona prolifera* (ELLIS and SOLANDER). I. A study of cellular function and differentiation. *J. exp. Zool.*, **154**, 135-152.
- SIMPSON, T. L. (1968). The biology of the marine sponge *Microciona prolifera* (ELLIS and SOLANDER). II. Temperature-related, annual changes in functional and reproductive elements with a description of larval metamorphosis. *J. exp. mar. Biol. Ecol.*, **2**, 252-277.
- SINGH, B. N. (1946). A method of estimating the number of soil protozoa, especially amoeba, based on their differential feeding on bacteria. *Ann. appl. Biol.*, **33**, 112-119.
- SINGH, B. N. (1950). A culture method for growing small free-living amoebae for the study of their nuclear division. *Nature, Lond.*, **165**, 65-66.
- SINNHUBER, R. O., LAW, D. K., YU, T. C., MCKEE, T. B., HUBLON, W. F. and WOOD, J. W. (1961). *Res. Briefs Fish Commn Ore.* (Quoted in FRIEDMAN and SHIBKO, 1972.)
- SIVERTSEN, E. (1936). Über die chemische Zusammensetzung von Robbenmilch. *Nytt. Mag. Naturvid.*, **75**, 183-185.
- SIVERTSEN, E. (1941). On the biology of the harp seal, *Phoca groenlandica* ERXL. *Hvalråd. Skr.*, **26**, 1-166.
- SLADEN, W. P. (1879). On the Asteroidea and Echinoidea of the Korean Seas. *J. Linn. Soc. (Zool.)*, **14**, 424-445.
- SLAVIN, J. W. (1963). Freezing and cold storage. In M. E. Stansby (Ed.), *Industrial Fishery Technology*. Reinhold Publishing Corp., New York. pp. 288-308.
- SLEPTSOV, M. M. (1943). On the biology of reproduction of Pinnipedia of the Far East. *Zool. Zh.*, **22**, 109-128.
- SLIJPER, E. J. (1956). Some remarks on gestation and birth in Cetacea and other aquatic mammals. *Hvalråd. Skr.*, **41**, 1-62.
- SLIJPER, E. J. (1962). *Whales*, Hutchinson, London. (Transl. from Dutch by A. J. Pomerans.)

- SLIJPER, E. J. (1966). Functional morphology of the reproductive system in Cetacea. In K. S. Norris (Ed.), *Whales, Dolphins, and Porpoises*. University of California Press, Berkeley. pp. 277-319.
- SLOBODKIN, L. B. (1964). Experimental populations of Hydrida. *J. Anim. Ecol.*, **33** (Suppl.), 131-148.
- SLOBODKIN, L. B. (1968). Aspects of the future of ecology. *Biol. Sci., Tokyo*, **18**, 16-23.
- SLUITER, C. (1889). Die Evertebraten aus der Sammlung des Kgl. Naturwissenschaftlichen Vereins in Niederländisch-Indien in Batavia. Echinodermen; III. Asteroïdes. *Natuurk. Tijdschr. Ned.-Indië*, **48**, 297-313.
- SMITH, E. A. (1876). Descriptions of species of Asteriidae and Ophiuridae from Kerguelen's Island. *Ann. Mag. nat. Hist.* (Ser., 4), **17**, 105-113.
- SMITH, E. A. (1879). Echinodermata. *Phil. Trans. R. Soc.*, **168** (Suppl.), 564-568.
- SMITH, E. A. (1964). *A Seals Symposium*, Nature Conservancy, Edinburgh.
- SMITH, E. H. (1962). Studies of *Cucumaria curata* COWLES 1907. *Pacif. Nat.*, **3**, 233-246.
- SMITH, G. (1907). The fixation of the cypris larva of *Sacculina carcini* (THOMPSON) upon its host, *Carcinus maenas*. *Q. Jl Microsc. Sci.*, **51**, 625-632.
- SMITH, G. (1940). Factors limiting distribution and size in the starfish. *J. Fish. Res. Bd Can.*, **5**, 84-103.
- SMITH, G. J. D. and GASKIN, D. E. (1973). The diet of harbour porpoises (*Phocoena phocoena* L.) in coastal waters of eastern Canada, with special reference to the Bay of Fundy. *Can. J. Zool.*, **52**, 777-783.
- SMITH, H. W. (1936). The composition of urine in the seal. *J. cell. comp. Physiol.*, **7**, 465-474.
- SMITH, L. S. (1961). Clam-digging behavior in the starfish, *Pisaster brevispinus* (STIMPSON 1857). *Behaviour*, **18**, 148-153.
- SMITH, R. A., HOLMAN, J. A. and KRAMER, R. H. (1974). Automatic brine shrimp feeder. *Progve Fish Cult.*, **36**, 133.
- SMITH, W. C. and CREGEEN, T. N. (1935). An experiment in lobster rearing. *Proc. Trans. Lpool biol. Soc.*, **48**, 61-64.
- SMITH, W. L. and CHANLEY, H. M. (Eds) (1975). *Culture of Marine Invertebrate Animals*, Plenum Press, New York.
- SNEED, K. E. and CLEMENS, H. P. (1959). The use of human chorionic gonadotrophin to spawn warm-water fishes. *Progve Fish Cult.*, **21**, 17-20.
- SNIESZKO, S. F. (1957). Use of antibiotics in the diet of salmonid fishes. *Progve Fish Cult.*, **19**, 81-84.
- SNIESZKO, S. F. (1972). Nutritional fish diseases. In J. E. Halver (Ed.), *Fish Nutrition*. Academic Press, New York. pp. 404-437.
- SOH, C. L. and LAM, T. J. (1973). Induced breeding and early development of the rabbit-fish *Siganus oramin* (SCHNEIDER). *Proc. Symp. Biol. Res. Nat. Dev. Singapore*, **1973**, 49-56.
- SOKOLOV, V. YE. (1961). Determining the phase of the reproductive cycle in female *Delphinus delphis* L. by vaginal smears. (Russ.) In *Proceedings of Meetings of the Ichthyological Commission of the Academy of Sciences, USSR*, **12**, 68-82.
- SOKOLOV, V. YE. (1971). Cetacean research in the USSR. In G. Pilleri (Ed.), *Investigations on Cetacea*, Vol. III, Part 2. Prof. G. Pilleri, Waldau-Berne, Switzerland. pp. 317-346.
- SOKOLOVA, M. N. (1957). The feeding of some carnivorous deep-sea benthic invertebrates of the Far Eastern seas and the northwest Pacific Ocean. *Trans. Inst. Oceanol.*, **20**, 279-301. (Quoted from Transl. published 1959 by *Am. Inst. Biol. Sci.*, 227-244.)
- SOLDO, A. T. (1963). Axenic culture of *Paramecium*—some observations on the growth behavior and nutritional requirements of a particle-bearing strain of *Paramecium aurelia*. *Ann. N. Y. Acad. Sci.*, **108**, 380-388.
- SOLDO, A. T. (1967). The nutritional requirements of *Paramecium aurelia*. *J. Protozool.*, **14** (Suppl.), 12.
- SOLDO, A. T. and MERLIN, E. J. (1971). The cultivation of marine ciliates in axenic medium. *J. Protozool.*, **18** (Suppl.), 26.
- SOLDO, A. T. and MERLIN, E. J. (1972). The cultivation of symbiont-free marine ciliates in axenic medium. *J. Protozool.*, **19**, 519-524.
- SOLDO, A. T. and WAGTENDONK, W. J. VAN (1967). A method for the mass collection of axenically cultivated *Paramecium aurelia*. *J. Protozool.*, **14**, 497-498.

- SOLDO, A. T. and WAGTENDONK, W. J. VAN (1969). The nutrition of *Paramecium aurelia*, STOCK 299. *J. Protozool.*, **16**, 500-506.
- SOLEIM, P. A. (1940). Sildelarvene på vårsildfeltet. (En foreløbig meddelelse.) *FiskDir. Skr., Ser. Havundersøkelser*, **6**, 39-55.
- SOLEIM, P. A. (1942). Årsaker til rike og fattige årganger av sild. *FiskDir. Skr., Ser. Havundersøkelser*, **7**, 1-39.
- SOLLAUD, E. (1923). Le développement larvaire des Palaemoninae. I. Partie descriptive. La condensation progressive de l'ontogénèse. *Bull. biol. Fr. Belg.*, **57**, 509-603.
- SORGELOOS, P. (1972). The influence of light on the growth rate of larvae of the brine shrimp, *Artemia salina* L. *Biol. Jb. Dodonaea*, **40**, 317-322.
- SORGELOOS, P. (1973a). High density culturing of the brine shrimp *Artemia salina* L. *Aquaculture*, **1**, 385-391.
- SORGELOOS, P. (1973b). The influence of algal food preparation on its nutritional efficiency for *Artemia salina* L. larvae. In *Proceedings of the Conference on Marine Invertebrate Larvae*. Rovinj, Yugoslavia.
- SORGELOOS, P. (1973c). First report on the triggering effect of light on the hatching mechanism of *Artemia salina* dry cysts. *Mar. Biol.*, **22**, 75-76.
- SORGELOOS, P., BENIJTS, F. and PERSOONE, G. (in press). Current research on the culture of the brine shrimp *Artemia salina* L. at the State University of Ghent (Belgium). In G. Persoone and E. Jaspers (Eds), *Tenth European Marine Biology Symposium*. Ostend, Belgium, 1975.
- SORGELOOS, P. and PERSOONE, G. (1973). A culture system for *Artemia*, *Daphnia*, and other invertebrates, with continuous separation of the larvae. *Arch. Hydrobiol.*, **72**, 133-138.
- SORGELOOS, P. and PERSOONE, G. (1975). Technological improvements for the cultivation of invertebrates as food for fishes and crustaceans. II. Hatching and culturing of the brine shrimp *Artemia salina* L. *Aquaculture*, **6**, 290-305.
- SOROKIN, YU. I. (1971). Bacterial populations as components of oceanic ecosystems. *Mar. Biol.*, **11**, 101-105.
- SOROKIN, YU. I. (1973). On the feeding of some scleractinian corals with bacteria and dissolved organic matter. *Limnol. Oceanogr.*, **18**, 380-385.
- SOROKIN, YU. I. (in press). Decomposition of organic matter and nutrient regeneration. In O. Kinne (Ed.), *Marine Ecology*, Vol. IV, Dynamics. Wiley, London.
- SPANGENBERG, D. B. (1964). New observations on the larval stages of *Aurelia aurita*. *Trans. Am. microsc. Soc.*, **83**, 448-455.
- SPANGENBERG, D. B. (1965). Cultivation of the life stages of *Aurelia aurita* under controlled conditions. *J. exp. Zool.*, **159**, 303-318.
- SPANGENBERG, D. B. (1968). Recent studies of strobilation in jellyfish. *Oceanogr. Mar. Biol. Ann. Rev.*, **6**, 231-247.
- SPAULDING, D. J. (1964). Comparative feeding habits of the fur seal, sea lion, and harbour seal on the British Columbia coast. *Bull. Fish. Res. Bd Can.*, **146**, 1-52.
- SPECTOR, W. S. (1956). *Handbook of Biological Data*, Saunders, Philadelphia.
- SPINDLER, M. and RÖTTGER, R. (1973). Der Kammerbauvorgang der Grossforaminifere *Heterostegina depressa* (Nummulitidae). *Mar. Biol.*, **18**, 146-159.
- SPITTLER, P. (1969). Zucht- und Fütterungsversuche an einigen Rädertierarten der Hiddenseer Gewässer. *Limnologica*, **7**, 207-211.
- SPRAGUE, J. B. (1969). Measurement of pollutant toxicity to fish. I. Bioassay methods for acute toxicity. *Water Research*, **3**, 793-821.
- SPRAGUE, J. B. (1970). Measurement of pollutant toxicity to fish. II. Utilizing and applying bioassay results. *Water Research*, **4**, 3-32.
- SPRAGUE, J. B. (1971). Measurement of pollutant toxicity to fish. III. Sublethal effects and 'safe' concentrations. *Water Research*, **5**, 245-266.
- ST. AMANT, L. S., CORKUM, K. C. and BROOM, J. G. (1963). Studies on growth dynamics of the brown shrimp, *Penaeus aztecus*, in Louisiana Waters. *Proc. Gulf Caribb. Fish. Inst.*, **15**, 14-26.
- STANCYK, S. E. (1973). Development of *Ophiolepis elegans* (Echinodermata: Ophiuroidea) and its implications in the estuarine environment. *Mar. Biol.*, **21**, 7-12.

- STANLEY, J. G. and SNEED, K. E. (1974). Artificial gynogenesis and its application in genetics and selective breeding of fishes. In J. H. S. Blaxter (Ed.), *The Early Life History of Fish*. Springer-Verlag, Berlin. pp. 527-536.
- STARK, J. N. (1959). *Nereis succinea* in the Sea of Azov. (Russ.) *Zool. Zh.*, **38**, 1634-1648.
- STEELE, J. H. (1974). *The Structure of Marine Ecosystems*, Harvard University Press, Cambridge, Massachusetts.
- STEELE, J. H. (1976). The role of predation in ecosystem models. *Mar. Biol.*, **35**, 9-11.
- STEINBERG, M. (1954). Studies on the mechanism of physiological dominance in *Tubularia*. *J. exp. Zool.*, **127**, 1-26.
- STEPHENS, G. C. (1972). Amino acid accumulation and assimilation in marine organisms. In J. W. Campbell and L. Goldstein (Eds), *Nitrogen Metabolism and the Environment*. Academic Press, London. pp. 155-184.
- STEPHENS, G. C. and SCHINSKE, R. A. (1961). Uptake of amino acids by marine invertebrates. *Limnol. Oceanogr.*, **6**, 175-181.
- STEPHENS, G. C. and VIRKAR, R. A. (1966). Uptake of organic material by aquatic invertebrates. IV. The influence of salinity on the uptake of amino acids by the brittle star *Ophiactis arenosa*. *Biol. Bull. mar. biol. Lab., Woods Hole*, **131**, 172-185.
- STEPHENSON, T. A. (1931). Development and the formation of colonies in *Pocillopora* and *Porites*. Part I. *Scient. Rep. Gt Barrier Reef Exped.*, **3**, 113-134.
- STEPHENSON, T. A. and STEPHENSON, A. (1933). Growth and asexual reproduction in corals. *Scient. Rep. Gt Barrier Reef Exped.*, **3**, 167-217.
- STERBA, G. (1967). *Aquarium Care*, Studio Vista, London.
- STERBENZ, F. J. (1956a). The axenic culture of *Paramecium caudatum*. *J. Protozool.*, **3** (Suppl.), 13.
- STERBENZ, F. J. (1956b). A demonstration of the need for thioctic acid for the growth of *Paramecium caudatum* in axenic culture. *J. Protozool.*, **3** (Suppl.), 14.
- STERBENZ, F. J. and LILLY, D. M. (1956). Factors influencing abnormal growth in suctorian Protozoa. *Trans. N.Y. Acad. Sci. (Ser. II)*, **18**, 522-530.
- STEVENSON, J. C. (1962). Distribution and survival of herring larvae (*Clupea pallasii* VALENCIENNES) in British Columbia Waters. *J. Fish. Res. Bd Can.*, **19**, 735-810.
- STILES, S. S. and LONGWELL, A. C. (1973). Fertilization, meiosis and cleavage in eggs from large mass spawnings of *Crassostrea virginica* GMELIN, the commercial American oyster. *Caryologia*, **26**, 253-262.
- STILLWELL, R. H. (1962). A stimulatory effect on the growth of *Paramecium caudatum* by products of *Colpidium campylum*. M.S. Dissertation, St. John's University.
- STILLWELL, R. H. (1967). *Colpidium*-produced RNA as a growth stimulant for *Tetrahymena*. *J. Protozool.*, **14**, 19-22.
- STILLWELL, R. H. and LILLY, D. M. (1962). Stimulation of growth in *Paramecium caudatum* by products of *Colpidium campylum*. *Am. Zool.*, **2**, 562.
- STILLWELL, R. H. and LILLY, D. M. (1964). The production of a growth stimulating factor by *Colpidium* in a chemically defined medium. *Am. Zool.*, **4**, 341.
- STIRLING, I. (1975). Factors affecting the evolution of social behaviour in the Pinnipedia. *Rapp. P.-v. Réun. Cons. int. Explor. Mer*, **169**, 205-212.
- STRATHMANN, R. (1973). Function of lateral cilia in suspension feeding of Lophophorates (Brachiopoda, Phoronida, Ectoprocta). *Mar. Biol.*, **23**, 129-136.
- STREET, R. J. (1964). Feeding habits of the New Zealand fur seal, *Arctocephalus forsteri*. *New Zealand Marine Dep. Fish., Tech. Rep.*, **9**, 1-20.
- STREHLER, B. L. (1964). Studies on the comparative physiology of aging. III. Effects of x-irradiation dosage on age-specific mortality rates of *Drosophila melanogaster* and *Campanularia flexuosa*. *J. Geront.*, **18**, 23-28.
- STRUHSAKER, J. W. (1966). Breeding, spawning, spawning periodicity and early development in the Hawaiian *Littorina*: *L. pintade* (WOOD), *L. picta* PHILIPPI and *L. scabra* (LINNAEUS). *Proc. malac. Soc. Lond.*, **37**, 137-166.
- STRUHSAKER, J. W. and COSTLOW, J. D., JR. (1968). Larval development of *Littorina picta* (Prosobranchia, Mesogastropoda), reared in the laboratory. *Proc. malac. Soc. Lond.*, **38**, 153-160.

- STRUHSAKER, J. W., HASHIMOTO, D. Y., GIRARD, S. M., PRIOR, F. T. and COONEY, T. D. (1973). Effect of antibiotics on survival of carangid fish larvae (*Caranx mate*), reared in the laboratory. *Aquaculture*, **2**, 53-88.
- STUDER, T. (1885). Die Seesterne Süd-Georgiens nach der Ausbeute der deutschen Polarstation in 1882 und 1883. *Mitt. naturh. Mus. Hamb.*, **2**, 141-166.
- SUBRAHMANYAM, C. B. and OPPENHEIMER, C. H. (1969). Food preferences and growth of grooved penaeid shrimp. In H. W. Youngken, Jr. (Ed.), *Food-drugs from the Sea*. (Proc. Mar. Technol. Soc., Wash. D.C., 1969, 65-75.)
- SUBRAHMANYAM, C. B. and OPPENHEIMER, C. H. (1970). The influence of feed levels on the growth of grooved penaeid shrimp in mariculture. *Proceedings of the Annual Workshop of the World Mariculture Society*, **1**, 91-100.
- SUGIL, K. and KINUMAKE, T. (1968). Distribution of vitamin E in a few species of fish. *Bull. Jap. Soc. scient. Fish.*, **34**, 420-428.
- SUGIURA, Y. (1963). On the life-history of rhizostome medusae. I. *Mastigias papua* L. AGASSIZ. *Annotnes zool. jap.*, **36**, 194-202.
- SUGIURA, Y. (1966). On the life-history of rhizostome medusae. IV. *Cephea cephea*. *Embryologia*, **9**, 105-122.
- SULKIN, S. D. (1975). The significance of diet in the growth and development of larvae of the blue crab, *Callinectes sapidus* RATHBUN, under laboratory conditions. *J. exp. mar. Biol. Ecol.*, **20**, 119-135.
- SULKIN, S. D. and EPIFANIO, C. E. (1975). Comparison of rotifers and other diets for rearing early larvae of the blue crab, *Callinectes sapidus* RATHBUN. *Estuar. coast. mar. Sci.*, **3**, 109-113.
- SULKIN, S. D. and MINASIAN, L. L. (1973). Synthetic sea water as a medium for raising crab larvae. *Helgoländer wiss. Meeresunters.*, **25**, 126-134.
- SULKIN, S. D. and NORMAN, K. (1976). A comparison of two diets in the laboratory culture of the zoeal stages of the brachyuran crabs *Rhithropanopeus harrisi* and *Neopanope* sp. *Helgoländer wiss. Meeresunters.*, **28**, 183-190.
- SUMICH, J. L. and McCAULEY, J. E. (1973). Growth of a sea urchin, *Allocentrotus fragilis*, off the Oregon Coast. *Pacif. Sci.*, **27**, 156-167.
- SUND, O. (1924). Snow and the survival of cod fry. *Nature, Lond.*, **113**, 163-164.
- SUNDARARAJ, B. I. and VASAL, S. (1973). Photoperiodic regulation of reproductive cycle in the catfish, *Heteropneustes fossilis* (BLOCH). In *Proceedings of IV International Congress on Endocrinology*. Washington, D.C., Ser. **273**, 180-184.
- SUNDARARAJ, B. I. and VASAL, S. (1976). Photoperiod and temperature control in the regulation of reproduction in the female catfish *Heteropneustes fossilis*. *J. Fish. Res. Bd Can.*, **33**, 959-973.
- SUNDERLIN, J. B., BRENNER, M., CASTAGNA, M., HIROTA, J., MENZEL, R. W. and ROELS, O. A. (in press). Comparative growth of hard shell clams (*Mercenaria mercenaria* LINNE and *Mercenaria campechiensis* GMELIN) and their F₁ cross in temperate, subtropical, and tropical natural waters and in tropical artificial upwelling mariculture system. *Proceedings of the 6th Annual Workshop of the World Mariculture Society*.
- SUTCLIFFE, W. H., JR. (1957). Observations on the growth rate of the immature Bermuda spiny lobster, *Panulirus argus*. *Ecology*, **38**, 526-529.
- SUTTON, M. F. (1957). The feeding mechanism, functional morphology and histology of the alimentary canal of *Terebella lapidaria* L. (Polychaeta). *Proc. zool. Soc. Lond.*, **129**, 487-523.
- SUZUKI, K. (1965). Biology of striped mullet, *Mugil cephalus* LINNÉ. I. Food contents of young. *Rep. Fac. Fish. prefect. Univ. Mie*, **5**, 295-305.
- SWAN, E. F. (1961). Some observations on the growth rate of sea urchins in the genus *Strongylocentrotus*. *Biol. Bull. mar. biol. Lab., Woods Hole*, **120**, 420-427.
- SWAN, E. F. (1966). Growth, anatomy, and regeneration. In R. A. Booloootian (Ed.), *Physiology of Echinodermata*. Interscience Publishers, New York. pp. 397-434.
- SWINGLE, H. S. (1961). Commercial fishworm production. Agricultural Experiment Station, Auburn University. *Progress Report Series No. 62* (unpaginated).

- TAKANO, H. (1971a). Breeding experiments of a marine littoral copepod *Tigriopus japonicus* MORI. *Bull. Tokai reg. Fish. Res. Lab.*, **64**, 71-79.
- TAKANO, H. (1971b). Notes on raising of an estuarine copepod *Gladioferens imparipes* THOMSON. *Bull. Tokai reg. Fish. Res. Lab.*, **64**, 81-87.
- TAKEDA, N. (1939). Sex determination and sex differentiation in the marine copepod, *Tigriopus japonicus* MORI. The influence of potassium chlorate (a preliminary note). *Zool. Mag.*, **51**, 1-13.
- TAKEDA, N. (1941a). Sex determination and sex differentiation in the marine copepod, *Tigriopus japonicus* MORI. I. The influence of potassium chlorate and potassium chloride. *Zool. Mag.*, **53**, 22-31.
- TAKEDA, N. (1941b). Sex determination and sex differentiation in the marine copepod, *Tigriopus japonicus* MORI. II. The influence of chlorotone, chloral hydrate and diiodotyrosin. *Zool. Mag.*, **53**, 158-170.
- TAKEDA, N. (1948). Experimental studies on the external influence on the sexuality of the marine copepod *Tigriopus japonicus* MORI. III. Effect of temperature. *Seibutu*, **3**, 12-21.
- TAKEDA, N. (1950). Experimental studies on the effect of external agencies on the sexuality of a marine copepod. *Physiol. Zool.*, **23**, 288-301.
- TAKEDA, N. (1954). Thermal adaptation in the marine copepod, *Tigriopus japonicus* MORI. *Seiri-Seitai*, **6**, 49-54.
- TAMPI, P. R. S. (1958). On the food of *Chanos chanos* (FORSKÅL). *Indian J. Fish.*, **5**, 107-117.
- TANAKA, Y. (1958). Feeding and digestive processes of *Stichopus japonicus*. *Bull. Fac. Fish. Hokkaido Univ.*, **9**, 14-28.
- TANAKA, Y. and INOUE, H. (1965). On redox potential of bottom materials in culture pond of the 'Kuruma' prawn, *Penaeus japonicus* BATE. *Bull. Jap. Soc. scient. Fish.*, **31**, 991-998.
- TANG, Y.-A. (1964). Induced spawning of striped mullet by hormone injection. *Jap. J. Ichthyol.*, **12**, 23-28.
- TARAKANOV, V. I. (1967). Contemporary view on the possibility of cultivating nematodes in vitro until the reproductive stage. *Temat sb rab po gel'mintol sel-kokhoz zhivotn*, **13**, 298-318. (Transl.: *Biol. Zh.*, **1968**, 7K85.)
- TARANTOLA, V. A. and WAGTENDONK, W. J. VAN (1959). Further nutritional requirements of *Paramecium aurelia*. *J. Protozool.*, **6**, 189-195.
- TARDENT, P. (1963). Regeneration in the Hydrozoa. *Biol. Rev.*, **38**, 293-333.
- TARDENT, P. and TARDENT, R. (1956). Wiederholte Regeneration bei *Tubularia*. *Pubbl. Staz. zool. Napoli*, **288**, 367-396.
- TARUSKI, A. G., OLNEY, C. E. and WINN, H. E. (1975). Chlorinated hydrocarbons in cetaceans. *J. Fish. Res. Bd Can.*, **32**, 2205-2209.
- TAUSON, A. O. (1925). Wirkung des Mediums auf das Geschlecht des Rotators *Asplanchna intermedia* HUDS. *Int. Rev. Hydrobiol.*, **13**, 130-170, 282-325.
- TAUSON, A. O. (1926). Über die Wirkung des Mediums auf das Geschlecht des Rotators *Asplanchna intermedia* HUDS. *Wilhelm Roux Arch. EntwMech. Org.*, **107**, 355-391.
- TAUSON, A. O. (1927). Über die Wirkung des Mediums auf das Geschlecht des Rotators *Asplanchna intermedia* HUDS. *Wilhelm Roux Arch. EntwMech. Org.*, **109**, 342-361.
- TAVOLGA, M. C. and ESSAPIAN, F. S. (1957). The behavior of the bottle-nosed dolphin (*Tursiops truncatus*): mating, pregnancy, parturition and mother-infant behavior. *Zoologica, N. Y.*, **42**, 11-31.
- TAYLOR, D. C. (1971). Killer whales *Orcinus orca* at Flamingo Park Zoo, and Cleethorpes Marineland and Zoo. *Int. Zoo Yb.*, **11**, 205-206.
- TEMPLEMAN, W. (1934). Lobster investigations in 1933. (Lobster hatching; effect of food, light, salinity and temperature on survival of lobster larvae). *Ann. Rep. biol. Bd Can.*, **1933**, 37-39.
- TEMPLEMAN, W. (1936a). Fourth stage larvae of *Homarus americanus* intermediate in form between normal third and fourth stages. *J. biol. Bd Can.*, **2**, 349-354.
- TEMPLEMAN, W. (1936b). The influence of temperature, salinity, light and food conditions on the survival and growth of the larvae of the lobster (*Homarus americanus*). *J. biol. Bd Can.*, **2**, 485-497.
- TERAMOTO, K. and KINOSHITA, S. (1961). Some information on the culture of *Artemia*. *Bull. Jap. Soc. scient. Fish.*, **27**, 801-804.

- TESCH, F.-W. (1975). Orientation in space: Animals. Fishes. In O. Kinne (Ed.), *Marine Ecology*, Vol. II, Physiological Mechanisms, Part 2. Wiley, London. pp. 657-707.
- TESCH, F.-W. (1977). *The Eel*, Chapman and Hall, London.
- THAMDRUP, H. M. (1935). Beiträge zur Ökologie der Wattenfauna auf experimenteller Grundlage. *Meddr. Kommn Danm. Fisk.-og Havunders. (Fiskeri)*, **10**, 1-125.
- THÉEL, H. (1886). Reports on the results of dredging by the United States coast survey steamer 'Blake' XXX Report on the Holothuroidea. *Bull. Mus. comp. Zool. Harv.*, **13**, 1-22.
- THEILACKER, G. H. and LASKER, R. (1974). Laboratory studies of predation by euphausiid shrimps on fish larvae. In J. H. S. Blaxter (Ed.), *The Early Life History of Fish*. Springer-Verlag, Berlin. pp. 287-299.
- THEILACKER, G. H. and MCMASTER, M. F. (1971). Mass culture of the rotifer *Brachionus plicatilis* and its evaluation as a food for larval anchovies. *Mar. Biol.*, **10**, 183-188.
- THOMAS, H. J. (1969). Lobster rearing. *Scott. Fish. Bull.*, **31**, 11-14.
- THOMAS, J. G. (1940). *Pomatoceros, Sabella and Amphitrite*. *L.M.B.C. Mem. typ. Br. mar. Pl. Anim.*, **33**, 1-88.
- THOMAS, L. P. (1960). A note on the feeding habits of the West Indian sea star *Orcaster reticulatus* (LINNAEUS). *Q. Jl Fla Acad. Sci.*, **23**, 167-168.
- THOMAS, M. M. (1972). Growth of the spiny lobster, *Panulirus homarus* (LINNAEUS), in captivity. *Indian J. Fish.*, **19**, 125-129.
- THOMSON, C. W. (1877). *The Voyage of the 'Challenger'*. *The Atlantic*, Vol. II, MacMillan, London.
- THOMSON, C. W. (1878). Notice of some peculiarities in the mode of propagation of certain echinoderms of the southern sea. *J. Linn. Soc. Zool.*, **13**, 55-79.
- THORHAUG, A., DEVANY, T. and MURPHY, B. (1971). Refining shrimp culture methods: the effect of temperature on early stages of the commercial pink shrimp. *Proc. Gulf Caribb. Fish. Inst.*, **23**, 125-132.
- THORSON, G. (1946). Reproduction and larval development of Danish marine bottom invertebrates, with special reference to the planctonic larvae in the Sound (Øresund). *Meddr Kommn Danm. Fisk.-og Havunders. (Plankton)*, **4**, 1-523.
- THUN, W. VON (1968). Autökologische Untersuchungen an freilebenden Nematoden des Brackwassers. Ph.D. Thesis, University of Kiel.
- THURBERG, F. P., DAWSON, M. A. and COLLIER, R. S. (1973). Effects of copper and cadmium on osmoregulation and oxygen consumption in two species of estuarine crabs. *Mar. Biol.*, **23**, 171-175.
- TICKELL, W. L. N. (1970). The exploitation and status of the common seal (*Phoca vitulina*) in Shetland. *Biol. Conserv.*, **2**, 179-184.
- TJETJEN, J. H. (1967). Observations on the ecology of the marine nematode *Monhystera filicaudata* ALLGEN, 1929. *Trans. Am. microsc. Soc.*, **86**, 304-306.
- TJETJEN, J. H. and LEE, J. J. (1972). Life cycles of marine nematodes. Influence of temperature and salinity on development of *Monhystera denticulata* TIMM. *Oecologia (Berl.)*, **10**, 167-176.
- TJETJEN, J. H. and LEE, J. J. (1973). Life history and feeding habits of the marine nematode, *Chromadora macrolaimoides* STEINER. *Oecologia (Berl.)*, **12**, 303-314.
- TJETJEN, J. H., LEE, J. J., MASTROPAOLO, C. and RULLMAN, J. (1971). Nutrition and life histories of salt marsh epiphytic nematodes: observations on *Chromadora axi* and *Chromadora macrolaimoides*. *Am. Soc. Limnol. Oceanogr.* (Abstracts.)
- TJETJEN, J. H., LEE, J. J., RULLMAN, J., GREENGART, A. and TROMPETER, J. (1970). Gnotobiotic culture and physiological ecology of the marine nematode *Rhabditis marina* BASTIAN. *Limnol. Oceanogr.*, **15**, 535-543.
- TIEWS, K. (1954). Die biologischen Grundlagen der Büsumer Garnelenfischerei. *Ber. dt. wiss. Komm. Meeresforsch.*, **13**, 235-269.
- TIEWS, K. (1970). Synopsis of biological data on the common shrimp *Crangon crangon* (LINNAEUS, 1758). *F.A.O. Fish. Rep.*, **57**, 1167-1224.
- TIEWS, K., GROPP, J. and KOOPS, H. (1975). On the development of optimal rainbow trout pellet feeds. *Coun. Meet. int. Coun. Explor. Sea (C.M.—I.C.E.S.)*, **E**: **5**, 1-30 (Mimeo).

- TIGHE-FORD, D. J. (1967). Possible mechanism for the endocrine control of breeding in a cirripede. *Nature, Lond.*, **216**, 920-921.
- TIGHE-FORD, D. J., POWER, M. J. D. and VAILE, D. C. (1970). Laboratory rearing of barnacle larvae for antifouling research. *Helgoländer wiss. Meeresunters.*, **20**, 393-405.
- TIMM, R. W. (1956). Marine nematodes from the Bay of Bengal. I. Phasmidea. *J. Bombay nat. Hist. Soc.*, **54**, 87-90.
- TOKUNAGO, T. (1970). Trimethylamine oxide and its decomposition in the bloody muscle of fish. *Bull. Jap. Soc. scient. Fish.*, **36**, 502-515.
- TOMILIN, A. G. (1950). Fin-thermoregulation organs in Cetacea. (Russ.) *Ryb. Khoz.*, **12**, 50.
- TOMILIN, A. G. (1951). On the thermoregulation in Cetacea. (Russ.) *Priroda, Mosk.*, **6**, 55-58.
- TOTH, S. E. (1965). Cultivation of marine hydroids. *Bios, Genova*, **36**, 63-65.
- TOURNIER, H. (1972). Acclimation conditions of shrimps, *Penaeus kerathurus* and *P. japonicus* in Languedocian coast waters. *Sci. Pêche*, **213**, 1-13.
- TOWNSEND, C. H. (1914). The porpoise in captivity. *Zoologica, N.Y.*, **16**, 289-299.
- TRAUT, W. (1966a). Eine Mutante mit vergrößerten Männchen-Eiern bei *Dinophilus gyro-ciliatus* (Archannelida). *Experientia*, **22**, 237-238.
- TRAUT, W. (1966b). Über die Kopulation bei *Dinophilus gyro-ciliatus* (Archannelida). *Zool. Anz.*, **177**, 402-411.
- TRAUT, W. (1968). Genetische Analyse zweier Mutanten von *Dinophilus gyro-ciliatus* (Archannelida) mit veränderter Eigröße. *Helgoländer wiss. Meeresunters.*, **18**, 296-316.
- TRAVIS, D. F. (1954). The molting cycle of the spiny lobster, *Panulirus argus* (LATREILLE). I. Molting and growth in laboratory-maintained individuals. *Biol. Bull. mar. biol. Lab., Woods Hole*, **107**, 433-450.
- TREAT, D. A. (1937). A comparative study of barnacle larvae. M.A. Thesis (unpublished), Western Reserve University, USA.
- TRIFONOVA, A. N. (1937). La physiologie de la différenciation et de la croissance. I. L'équilibre Pasteur-Meyerhof dans le développement des poissons. *Acta zool., Stockh.*, **18**, 375-445.
- TRIGT, H. VAN (1919). A contribution to the physiology of the freshwater sponges (Spongillidae). *Tijdschr. Diergeneesk. (Ser. 2)*, **17**, 1-220.
- TRUSCOTT, B., IDLER, D. R., HOYLE, R. J. and FREEMAN, H. C. (1968). Sub-zero preservation of Atlantic salmon sperm. *J. Fish. Res. Bd Can.*, **25**, 363-372.
- TRUSCOTT, B. and IDLER, D. R. (1969). An improved extender for freezing salmon spermatozoa. *J. Fish. Res. Bd Can.*, **26**, 3254-3258.
- TSOY, R. M. (1972). Chemical gynogenesis of *Salmo irideus* and *Coregonus peled*. *Genetika*, **8**, 185-188.
- TSUDA, R. T. and BRYAN, P. G. (1973). Food preferences of juvenile *Siganus rostratus* and *S. spinus* in Guam. *Copeia*, **1973**, 604-606.
- TSUDA, R. T., BRYAN, P. G., FITZGERALD, W. J. and TOBIAS, W. J. (1974). Juvenile-adult rearing of *Siganus* (Pisces: Siganidae) in Guam. SPC *Seventh Technical Meeting on Fisheries, NUKU' ALOFA, Tongo*. (Manuscript report.)
- TSUJITANI, J. (1898). Über die Reinkultur der Amöben. *Zentbl. Bakt. I*, **24**, 666-670.
- Tsunoda, N., Terao, Y., Nakamura, T. and Inoue, Y. (1970). Growth and food intake of artificially developed *Strongylocentrotus pulcherrimus*. *Aquiculture*, **17**, 155-165.
- TURNBULL, F. (1876). On the anatomy and habits of *Nereis virens*. *Trans. Conn. Acad. Arts Sci.*, **3**, 265-281.
- TUSOV, J. and DAVIS, L. V. (1971). Influence of environmental factors on the growth of *Bougainvillia* sp. In H. M. Lenhoff, L. Muscatine and L. V. Davis (Eds), *Experimental Coelenterate Biology*. University of Hawaii Press, Honolulu. pp. 52-65.
- TUTTLE, R. C. and LOEBLICH, A. R., III. (1975). An optimal growth medium for the dinoflagellate *Cryptothecodinium cohnii*. *Phycologia*, **14**, 1-8.
- TUZET, O. and FONTAINE, M. (1937). Sur la spermatogénèse de l'Anguille argentée (*Anguilla vulgaris* CUV.). *Arch. Zool. exp. gén.*, **78**, 199-215.
- TYLER, A. (1948). Fertilization and immunity. *Physiol. Rev.*, **28**, 180-219.
- TYLER, A. (1949). A simple, non-injurious method for inducing repeated spawning of sea urchins and sand dollars. *Collect. Net.*, **19**, 19-20.
- TYLER, A. (1953). Prolongation of life-span of sea urchin spermatozoa, and improvement of the

- fertilization reaction, by treatment of spermatozoa and eggs with metal-chelating agents (amino acids, versene, DEDTC, oxine, cupron). *Biol. Bull. mar. biol. Lab., Woods Hole*, **104**, 224-239.
- TYLER, A. and ROTHSCHILD, Lord (1951). Metabolism of sea urchin spermatozoa and induced anaerobic motility in solutions of amino acids. *Proc. Soc. exp. Biol. Med.*, **76**, 52-58.
- TYLER, A. and TYLER, B. S. (1966a). The gametes; some procedures and properties. In R. A. Boolootian (Ed.), *Physiology of Echinodermata*. Interscience Publishers, New York. pp. 639-682.
- TYLER, A. and TYLER, B. S. (1966b). Physiology of fertilization and early development. In R. A. Boolootian (Ed.), *Physiology of Echinodermata*. Interscience Publishers, New York. pp. 683-741.
- TZONIS, K. (1938). Beeinflussung der Geschlechtsverhältnisse bei *Dinophilus apatris* KORSCH. durch Aussenbedingungen. *Zool. Jb. (Allg. Zool. Physiol. Tiere)*, **58**, 539-550.
- UBISCH, L. VON (1953). Über die Zahl der Flossenstrahlen bei *Pleuconectes platessa*, *Pl. flesus* und der Bastard und Rückkreuzungen zwischen beiden Arten. *Zool. Anz.*, **151**, 75-86.
- UCHIYAMA, K. (1965). Californian sea-lion twins at Tokuyama Zoo. *Int. Zoo Yb.*, **5**, 111.
- UHLIG, G. (1963). Untersuchungen über die Folliculiniden (Ciliata; Heterotricha) der Deutschen Bucht. *Veröff. Inst. Meeresforsch. Bremerh.*, **1** (Sonderbd.), 115-121.
- UHLIG, G. (1965). Die mehrgliedrige Kultur litoraler Folliculiniden. *Helgoländer wiss. Meeresunters.*, **12**, 52-60.
- UHLIG, G. (1972a). Entwicklung von *Noctiluca miliaris*. *Inst. wiss. Film, Göttingen*, Film C897, 1-15.
- UHLIG, G. (1972b). *Metafolliculina andrewsi* (Ciliata). Fortpflanzung. FILM E 649/1964. *Publ. zu Wiss. Filmen* (Sekt. Biol.), **5**, 400-411.
- UKELES, R. (1971). Nutritional requirements in shellfish culture. In *Proceedings of the Conference on Artificial Propagation of Commercially Valuable Shellfish—Oysters*. Collège of Marine Studies, University Delaware, Newark.
- ULMER, F. A., JR. (1962). The Southern elephant seal *Mirounga leonina* in captivity. *Int. Zoo Yb.*, **4**, 26-32.
- UNGER, H. (1962). Experimentelle und histologische Untersuchungen über Wirkfaktoren aus dem Nervensystem von *Asterias glacialis*. *Zool. Jb.*, **69**, 481-536.
- URRY, D. L. (1965). Observations on the relationship between the food and survival of *Pseudocalanus elongatus* in the laboratory. *J. mar. biol. Ass. U.K.*, **45**, 49-58.
- USHAKOV, B. P. (1968). Cellular resistance adaptation to temperature and thermostability of somatic cells with special reference to marine animals. *Mar. Biol.*, **1**, 153-160.
- USUI, A. (1974). *Eel Culture* (Translated from the Japanese), Fishing News (Books) Ltd., Surrey.
- VACQUIER, V. D. (1971). The effects of glucose and lithium chloride on the appearance of β -1,3 glucano-hydrolase activity in sand dollar plutei. *Devl Biol.*, **26**, 11-16.
- VAHLKAMPF, E. (1905). Beiträge zur Biologie und Entwicklungsgeschichte von *Amoeba limax* einschließlich der Züchtung auf künstlichen Nährböden. *Arch. Protistenk.*, **5**, 167-220.
- VALENTINČIĆ, T. (1973). Food finding and stimuli to feeding in the sea star *Marthasterias glacialis*. *Neth. J. Sea Res.*, **7**, 191-199.
- VALLE, M. R. DEL (1960). The nematode as an assay organism for staphylococcal enterotoxin. M.S. Thesis, University of Wisconsin.
- VALLET, F., BERHAUT, J., LERAY, C., BONNET, B. and PIC, C. (1970). Preliminary experiments on the artificial feeding of Mugilidae. *Helgoländer wiss. Meeresunters.*, **20**, 610-619.
- VANDERZANT, C., MROZ, E. and NICKELSON, R. (1970). Microbial flora of Gulf of Mexico and pond shrimp. *Milk Fd Technol.*, **33**, 346-350.
- VANEY, C. (1907). Échinodermes Holothuriés. In *Expédition Antarctique Française (1903-1905)*, Masson, Paris.
- VANEY, C. (1914). Holothuries. In *Deuxième Expédition Antarctique Française (1908-1910)*, Masson, Paris.
- VANEY, C. (1925). L'incubation chez les Holothuries. *Trav. Stn zool. Wimereux*, **9**, 254-274.
- VARIKUL, V., PHUMIPHOL, S. and HONGPROMYART, M. (1970). Preliminary experiment on pond rearing and some biological studies of *Scylla serrata*. *Proc. Indo-Pacif. Fish. Coun. 14th Session*, Document IPFC/C70/Sym.49.

- VASIL'eva, G. L. and OKUNEVA, G. L. (1961). Experiments on rearing the rotifer *Brachionus rubens* EHRRG. as food for young fish. (Russ.) *Vop. Ikhtiolog.*, **1**, 752-761.
- VASSILEVA-DRYANOVSKA, O. and BELCHEVA, R. (1965). Radiation gynogenesis in *Salmo irideus* GIBB. *C.r. Acad. bulg. Sci.*, **18**, 359-362.
- VAZ-FERREIRA, R. (1975). Behavior of the southern sea lion, *Otaria flavescens* (SHAW), in the Uruguayan islands. *Rapp. P.-v. Résum. Cons. int. Explor. Mer*, **169**, 219-227.
- VEDAVYASA RAO, P. (1970). Synopsis of biological data on the penaeid prawn *Parapenaeopsis styliifera* (H. MILNE EDWARDS, 1837). *F.A.O. Fish. Rep.*, **57**, 1575-1605.
- VEDAVYASA RAO, P. and KATHIRVEL, M. (1973). On the breeding of a penaeid prawn *Metapenaeus dobsoni* in the brackish water medium. *Indian J. Fish.*, **20**, 228-230.
- VEDROS, N. A., SMITH, A. W., SCHONEWALD, J., MIGAKI, G. and HUBBARD, R. C. (1971). Leptospirosis epizootic among California sea lions. *Science, N.Y.*, **172**, 1250-1251.
- VEILLET, A. (1943). Note sur le dimorphisme des larves de *Lernaeodiscus galathea* NORMAN et SCOTT et sur la nature des 'mâles larvaires' des Rhizocéphales. *Bull. Inst. océanogr. Monaco*, **841**, 1-4.
- VEILLET, A. (1947). Métamorphose de la larve cypris du Rhizocéphale *Septosaccus cuenoti* DUB. parasite du pagure *Diogenes pugilator*. *C.r. heb. Séanc. Acad. Sci., Paris*, **224**, 957-959.
- VEILLET, A. (1951). Sur l'élevage des larves des Rhizocéphales. *Bull. Inst. océanogr. Monaco*, **990**, 1-7.
- VEILLET, A. (1952). Métamorphose de la larve cypris du Rhizocéphale *Gemmosaccus sulcatus* LILLJEBORG. *C.r. heb. Séanc. Acad. Sci.*, **234**, 1310-1312.
- VEITCH, F. P. and HIDU, H. (1971). Gregarious setting in the American oyster *Crassostrea virginica* GMELIN. I. Properties of a partially purified 'setting factor'. *Chesapeake Sci.*, **12**, 173-178.
- VENABLES, U. M. and VENABLES, L. S. V. (1957). Mating behaviour of the seal *Phoca vitulina* in Shetland. *Proc. zool. Soc. Lond.*, **128**, 387-396.
- VENABLES, U. M. and VENABLES, L. S. V. (1959). Vernal coition of the seal *Phoca vitulina* in Shetland. *Proc. zool. Soc. Lond.*, **132**, 665-669.
- VENKATARAMIAH, A. (1971). Dry feed for postlarval shrimp. *F.A.O. Aquaculture Bull.*, **3**, 4.
- VENKATARAMIAH, A. and LAKSHMI, G. J. (1973). Plastic wading pools for holding and raising penaeid shrimp under laboratory conditions. In *Proceedings 3rd Annual Workshop of the World Mariculture Society, 1972*. Louisiana State University, Baton Rouge, Louisiana. pp. 255-265.
- VENKATARAMIAH, A., LAKSHMI, G. J. and GUNTER, G. (1973a). The effects of salinity, temperature and feeding levels on the food conversion, growth and survival rates of the shrimp *Penaeus aztecus*. In *Proceedings 3rd Food-Drugs from the Sea Conference, 1972*. Marine Technology Society, Washington, D.C. pp. 29-42.
- VENKATARAMIAH, A., LAKSHMI, G. J. and GUNTER, G. (1973b). The effects of salinity and feeding levels on the growth rate and food conversion efficiency of the shrimp *Penaeus aztecus*. In *Proceedings 3rd Annual Workshop of the World Mariculture Society, 1972*. Louisiana State University, Baton Rouge, Louisiana. pp. 267-283.
- VENKATARAMIAH, A., LAKSHMI, G. J. and GUNTER, G. (1975). Effect of protein level and vegetable matter on growth and food conversion efficiency of brown shrimp. *Aquaculture*, **6**, 115-125.
- VENKATARAMIAH, A., LAKSHMI, G. J. and GUNTER, G. (in press). The effects of some environmental and nutritional factors in brown shrimp *Penaeus aztecus* IVES culture in the laboratory. In G. Persoone and E. Jaspers (Eds), *Tenth European Marine Biology Symposium*. Ostend, Belgium, 1975.
- VERNBERG, W. B. and VERNBERG, J. (1972). The synergistic effects of temperature, salinity and mercury on survival and metabolism of the adult fiddler crab, *Uca pugilator*. *Fish. Bull. U.S.*, **70**, 415-420.
- VERRILL, A. E. (1873). Report upon the invertebrate animals of Vineyard Sound and the adjacent waters, with an account of the physical characters of the region. *Rep. U.S. Commr. Fish. 1871-1872*, 295-747.
- VERRILL, A. E. (1914). Monograph of the shallow-water starfishes of the North Pacific coast from the Arctic Ocean to California. *Harriman Alaska Exped. (Smithsonian Instn)*, **14**, 1-408.

- VERWEY, J. (1958). Orientation in migrating marine animals and a comparison with that of other migrants. *Archs néerl. Zool.*, **13** (Suppl.), 418-445.
- VEVERS, H. G. (1956). Observations on feeding mechanisms in some echinoderms. *Proc. zool. Soc. Lond.*, **126**, 484-485.
- VIGLIERCHIO, D. R. and JOHNSON, R. N. (1971). On the maintenance of *Deontostoma californicum*. *J. Nematology*, **3**, 86-88.
- VILELA, M. H. (1969). The life cycle of *Tisbe* sp. (Copepoda, Harpacticoida) under laboratory conditions. *Notas Estud. Inst. Biol. mar., Lisb.*, **36**, 1-16.
- VILLADOLID, D. V. (1957). The food habits of fry and fingerlings of milkfish (*Chanos chanos* FORSKÅL). *Aranata J. Agric.*, **4**, 1-23.
- VILLADOLID, D. V. and VILLALUZ, D. K. (1951). The cultivation of Sugpo (*Penaeus monodon* FABRICIUS) in the Philippines. *Philipp. J. Fish.*, **1**, 16-28.
- VILLANI, P. and LUMARE, F. (1975). Nota sull'accrescimento ovarico indotta in *Anguilla anguilla* (L.). *Investigación pesq.*, **39**, 187-197.
- VINCENCIO, Z. T. (1964). Studies on the algal food habits of milkfish *Chanos chanos* (FORSKÅL). M.S. Thesis, University of the Philippines.
- VOLKMANN-ROCCO, B. and FAVA, G. (1969). Two sibling species of *Tisbe* (Copepoda, Harpacticoida): *Tisbe reluctans* and *T. persimilis* n. sp. Research on their morphology and population dynamics. *Mar. Biol.*, **3**, 159-164.
- VUILLEMIN, S. (1968). Élevage de serpulines (Annélides Polychètes). (Engl. summary.) *Vie Milieu*, **19** (1A), 195-199.
- WADA, K. (1971). Food and feeding habit of Northern fur seals along the coast of Sanriku. *Bull. Tokai reg. Fish. Res. Lab.*, **64**, 1-37.
- WADA, S. (1942). On the artificial fertilization and development of *Pinctada maxima* (JAMESON). (Jap.) *Kagakunanyo*, **4**, 26-43.
- WADA, S. (1947). Artificial fertilization of *Pinctada martensii* by ammoniated water. *Bull. Jap. Soc. scient. Fish.*, **13**, 59.
- WAGNER, A. (1960). Maintenance of a marine snail in the laboratory. *J. Parasit.*, **46**, 186.
- WAGNER, E. (1954). The effects of antibiotics and arsanilic acid on the growth of rainbow trout fingerlings. *Progre Fish. Cult.*, **16**, 30-38.
- WAGTENDONK, W. J. VAN (1955). The nutrition of ciliates. In S. H. Hutner and A. Lwoff (Eds), *Biochemistry and Physiology of Protozoa*, Vol. II. Academic Press, New York. pp. 57-90.
- WAGTENDONK, W. J. VAN (Ed.) (1974). *Paramecium, A Current Survey*, Elsevier Scientific Publication Co., Amsterdam.
- WAGTENDONK, W. J. VAN, CONNER, R. L., MILLER, C. A. and RAO, M. R. R. (1953). Growth requirements of *Paramecium aurelia* var. 4, stock 51.7 sensitive and killers to axenic medium. *Ann. N.Y. Acad. Sci.*, **56**, 929-937.
- WAGTENDONK, W. J. VAN and HACKETT, P. L. (1949). The culture of *Paramecium aurelia* in the absence of other living organisms. *Proc. natn. Acad. Sci. U.S.A.*, **35**, 155-159.
- WAGTENDONK, W. J. VAN and SOLDI, A. T. (1970). Nitrogen metabolism in protozoa. In J. W. Campbell (Ed.), *Comparative Biochemistry of Nitrogen Metabolism*, Vol. I. Academic Press, New York. pp. 1-56.
- WAINWRIGHT, S. A. (1963). Skeletal organization in the coral *Pocillopora damicornis*. *Q. Jl microsc. Sci.*, **104**, 169-183.
- WALKER, G. (1973). Frontal horns and associated gland cells of the nauplii of the barnacles, *Balanus hameri*, *Balanus balanoides* and *Elminius modestus* (Crustacea: Cirripedia). *J. mar. biol. Ass. U.K.*, **53**, 455-463.
- WALKER, G., RAINBOW, P. S., FOSTER, P. and CRISP, D. J. (1975). Barnacles: possible indicators of zinc pollution? *Mar. Biol.*, **30**, 57-65.
- WALKER, I. (1975). The effect of saline concentration on the dynamics of the fission rate in the marine ciliate *Keronomopsis rubra* EHRENBERG (Hypotricha, Oxytrichidae). *Revue suisse Zool.*, **82**, 349-367.
- WALKER, M. G. (1971). Effect of starvation and exercise on the skeletal muscle fibres of the cod (*Gadus morhua* L.) and coalfish (*Gadus virens* L.), respectively. *J. Cons. int. Explor. Mer.*, **33**, 421-427.
- WALKER, W. A. (1975). Review of the live-capture fishery for smaller cetaceans taken in Southern California waters for public display, 1966-73. *J. Fish. Res. Bd Can.*, **32**, 1197-1211.

- WALLIS, A. P. L. (1973). The maintenance of satisfactory water conditions in dolphinarium. *Aquatic Mammals*, **1**, 19–25.
- WALNE, P. R. (1956). Bacteria in experiments on rearing oyster larvae. *Nature, Lond.*, **178**, 91.
- WALNE, P. R. (1958). The importance of bacteria in laboratory experiments on rearing the larvae of *Ostrea edulis*. *J. mar. biol. Ass. U.K.*, **37**, 415–425.
- WALNE, P. R. (1965). Observations on the influence of food supply and temperature on the feeding and growth of the larvae of *Ostrea edulis* L. *Fishery Invest., Lond.* (Ser. II), **24**, 1–45.
- WALNE, P. R. (1966). Experiments in the large-scale culture of the larvae of *Ostrea edulis* L. *Fishery Invest., Lond.* (Ser. II), **25**, 1–53.
- WALNE, P. R. (1967). The food value of 13 species of unicellular algae to *Artemia salina*. *Coun. Meet. int. Coun. Explor. Sea (C.M.—I.C.E.S.)*, **E: 5**.
- WALNE, P. R. (1970a). Present problems in the culture of the larvae of *Ostrea edulis*. *Helgoländer wiss. Meeresunters.*, **20**, 514–525.
- WALNE, P. R. (1970b). Studies on food value of nineteen genera of algae to juvenile bivalves of the genera *Ostrea*, *Crassostrea*, *Mercenaria* and *Mytilus*. *Fishery Invest., Lond.* (Ser. II), **26**, 1–62.
- WALNE, P. R. (1974a). *Culture of Bivalve Molluscs, 50 years' Experience at Conwy*, Fishing News (Books) Ltd., Surrey.
- WALNE, P. R. (1974b). Shellfish culture. In F. R. Harden Jones (Ed.), *Sea Fisheries Research*. Elek, London. pp. 379–398.
- WALNE, P. R. and SPENCER, B. E. (1971a). Further experiments on the growth of the spat of *Ostrea edulis* L. in a closed water system. *Coun. Meet. int. Coun. Explor. Sea (C.M.—I.C.E.S.)*, **K:24**.
- WALNE, P. R. and SPENCER, B. E. (1971b). The introduction of the Pacific oyster (*Crassostrea gigas*) into the United Kingdom. *Shellfish Information Leaflet*, **21**.
- WALSBY, J. R. (1970). Energy flow in the salt marsh ecosystem of Georgia. *Ecology*, **43**, 614–624.
- WANGERSKY, P. J. (in press). Production of dissolved organic matter. In O. Kinne (Ed.), *Marine Ecology*, Vol. IV, Dynamics. Wiley, London.
- WARBURTON, F. E. (1958a). The manner in which the sponge *Cliona* bores in calcareous objects. *Can. J. Zool.*, **36**, 555–562.
- WARBURTON, F. E. (1958b). Reproduction of fused larvae in the boring sponge *Cliona celata* GRANT. *Nature, Lond.*, **181**, 493–494.
- WARBURTON, F. E. (1966). The behaviour of sponge larvae. *Ecology*, **47**, 672–674.
- WARD, J. A. (1965). An investigation on the swimming reaction of the anemone *Stomphia coccinea*. II. Histological location of a reacting substance in the asteroid *Dermasterias imbricata*. *J. exp. Biol.*, **158**, 365–372.
- WARD, W. W. (1974). Aquarium systems for the maintenance of ctenophores and jellyfish and for the hatching and harvesting of brine shrimp (*Artemia salina*) larvae. *Chesapeake Sci.*, **15**, 116–118.
- WARE, S. (1968). Porifera together with Archaeocyatha. *Zool. Rec.*, **102**, 1–23.
- WARTZOK, D., RAY, G. C. and MARTIN, H. B., III. (1975). A recording instrument package for use with marine mammals. *Rapp. P.-v. Réun. Cons. int. Explor. Mer*, **169**, 445–450.
- WASSERTHAL, W. (1973). Zur Ei- und Embryonalentwicklung des Hydroidpolypen *Eudendrium armatum*. *Helgoländer wiss. Meeresunters.*, **25**, 93–125.
- WATERMAN, A. J. (1934). Observations on reproduction, prematuration, and fertilization in *Sabellaria vulgaris*. *Biol. Bull. mar. biol. Lab., Woods Hole*, **67**, 97–114.
- WATERMAN, T. H. and CHASE, F. A., JR. (1960). General crustacean biology. In T. H. Waterman (Ed.), *Physiology of Crustacea*, Vol. I. Academic Press, New York. pp. 1–33.
- WATSON, A. T. (1890). The tube-building habits of *Terebella littoralis*. *Jl R. microsc. Soc.*, **1890**, 685–689.
- WATSON, A. T. (1891). The protective device of an annelid. *Nature, Lond.*, **44**, 507–508.
- WATSON, A. T. (1907). Habits of tube-building worms. *Rep. Br. Ass. Advmt Sci.*, **1907**, 599.
- WATZKA, M. (1928). Die Rotatorienfauna der Cakowitzer Zuckerfabriksteiche und Versuche über das Auftreten von Rotatorien-Männchen und über die Entwicklungszeit der Dauerier. *Int. Revue ges. Hydrobiol.*, **19**, 430–451.

- WEBBER, H. H. (1970). The development of a maricultural technology for the penaeid shrimps of the Gulf and Caribbean Region. *Helgoländer wiss. Meeresunters.*, **20**, 455-463.
- WEEL, P. B. VAN (1949). On the physiology of the tropical freshwater sponge *Spongilla proliferans* ANNAND. I. Ingestion, digestion, and excretion. *Physiologia comp. Oecol.*, **1**, 110-126.
- WEESE, A. (1926). The food and digestive processes of *Strongylocentrotus droebachiensis*. *Publ. Puget Sound mar. biol. Stn.*, **5**, 165-179.
- WEILER-STOLT, B. (1960). Über die Bedeutung der interstitiellen Zellen für die Entwicklung und Fortpflanzung mariner Hydroiden. *Wilhelm Roux Arch. EntwMech. Org.*, **152**, 398-454.
- WELLER, C. and CHEW, K. (1973). Experiments in oyster raft culture at Clam Bay, Washington. *Proc. natn. Shellfish. Ass.*, **63**, 11.
- WELLS, G. P. (1945). The mode of life of *Arenicola marina* L. *J. mar. biol. Ass. U.K.*, **26**, 170-207.
- WELLS, G. P. (1949). The behaviour of *Arenicola marina* L. in sand, and the role of spontaneous activity cycles. *J. mar. biol. Ass. U.K.*, **28**, 447-464.
- WELLS, G. P. (1963). Barriers and speciation in lugworms. Speciation in the sea. *Systematics Association, London, Publ.*, **5**, 79-98.
- WELLS, G. P. (1964). Temperature, taxonomic technique and the zoogeography of lugworms (Arenicolidae, Polychaeta). *Helgoländer wiss. Meeresunters.*, **10**, 404-410.
- WELLS, G. P. and DALES, R. P. (1951). Spontaneous activity patterns in animal behaviour: the irrigation of the burrow in the polychaetes, *Chaetopterus variopedatus* RENIER and *Nereis diversicolor* O. F. MÜLLER. *J. mar. biol. Ass. U.K.*, **29**, 661-680.
- WELLS, H. W., WELLS, M. J. and GRAY, I. E. (1961). Food of the sea-star *Astropecten articulatus*. *Biol. Bull. mar. biol. Lab., Woods Hole*, **120**, 265-271.
- WELLS, W. F. (1920). Growing oysters artificially. *Conservationist*, **3**, 151.
- WELLS, W. F. (1926). A new chapter in shellfish culture. *N.Y. St. Conserv.*, **15**, 1-36.
- WELLS, W. F. (1927). Report of the experimental shellfish station. *N.Y. St. Conserv.*, **16**, 1-22.
- WELSH, J. H. (1954). Marine invertebrate preparations useful in the bioassay of acetylcholine and 5-hydroxytryptamine. *Nature, Lond.*, **173**, 955-956.
- WERMUTH, J. F. and BARNES, C. D. (1967). The effects of x-irradiation of stolon growth in *Campanularia flexuosa*. *J. gen. Physiol.*, **50**, 2505.
- WERMUTH, J. F. and BARNES, C. D. (1969). Differential radioprotection by glutathione of two growth functions in the hydroid *Campanularia flexuosa*. *Biol. Bull. mar. biol. Lab., Woods Hole*, **137**, 375-383.
- WERNER, B. (1951). Über die Bedeutung der Wasserstromerzeugung und Wasserstromfiltration für die Nahrungsaufnahme der ortsgewundenen Meeresschnecke *Crepidula fornicata* L. (Gastropoda Prosobranchia). *Zool. Anz.*, **146**, 97-113.
- WERNER, B. (1953a). Beobachtungen über den Nahrungserwerb und die Metamorphose der Metatrochophora von *Chaetopterus variopedatus* RENIER u. CLAPARÈDE (Polychaeta Sedentaria). *Helgoländer wiss. Meeresunters.*, **4**, 225-238.
- WERNER, B. (1953b). Über den Nahrungserwerb der Calyptraeidae (Gastropoda Prosobranchia). Morphologie, Histologie und Funktion der am Nahrungserwerb beteiligten Organe. *Helgoländer wiss. Meeresunters.*, **4**, 260-315.
- WERNER, B. (1954a). Eine Beobachtung über die Wanderung von *Arenicola marina* L. (Polychaeta Sedentaria). *Helgoländer wiss. Meeresunters.*, **5**, 93-102.
- WERNER, B. (1954b). Über die Winterwanderung von *Arenicola marina* L. (Polychaeta Sedentaria). *Helgoländer wiss. Meeresunters.*, **5**, 353-378.
- WERNER, B. (1955a). On the development and reproduction of the anthomedusan *Margelopsis haeckeli* HARTLAUB. *Ann. N.Y. Acad. Sci.*, **62**, 1-30.
- WERNER, B. (1955b). Über die Fortpflanzung der Anthomeduse *Margelopsis haeckeli* HARTLAUB durch Subitan- und Dauereier und die Abhängigkeit ihrer Bildung von äußeren Faktoren. *Zool. Anz.*, **18** (Suppl.), 124-133.
- WERNER, B. (1956). Über die entwicklungsphysiologische Bedeutung des Fortpflanzungswechsels der Anthomeduse *Rathkea octopunctata* M. SARS. *Zool. Anz.*, **156**, 159-177.
- WERNER, B. (1958). Die Verbreitung und das jahreszeitliche Auftreten der Anthomeduse *Rathkea octopunctata* (M. Sars) sowie die Temperaturabhängigkeit ihrer Entwicklung und Fortpflanzung. *Helgoländer wiss. Meeresunters.*, **6**, 137-170.

- WERNER, B. (1959). Das Prinzip des endlosen Schleimfilters beim Nahrungserwerb wirbelloser Meerestiere. *Int. Revue ges. Hydrobiol.*, **44**, 181-215.
- WERNER, B. (1961). Morphologie und Lebensgeschichte sowie Temperaturabhängigkeit der Verbreitung und des jahreszeitlichen Auftretens von *Bougainvillia superciliaris* (L. AGASSIZ) (Anthomedusae). *Helgoländer wiss. Meeresunters.*, **7**, 206-237.
- WERNER, B. (1963). Experimentelle Beobachtungen über die Wirksamkeit von Außenfaktoren in der Entwicklung von Hydrozoen und Erörterung ihrer Bedeutung für die Evolution. *Veröff. Inst. Meeresforsch. Bremerh.*, **1** (Sonderbd.), 153-177.
- WERNER, B. (1966). *Stephanoscyphus* (Scyphozoa, Coronatae) und seine direkte Abstammung von den fossilen Conulata. *Helgoländer wiss. Meeresunters.*, **13**, 317-347.
- WERNER, B. (1967). Morphologie, Systematik und Lebensgeschichte von *Stephanoscyphus* (Scyphozoa, Coronatae) sowie seine Bedeutung für die Evolution der Scyphozoa. *Verh. dt. Zool. Ges. Göttingen 1966, Zool. Anz.*, **30** (Suppl.), 297-319.
- WERNER, B. (1968). Polypengeneration und Entwicklungsgeschichte von *Eucheilota maculata* (Thecata-Leptomedusae). Mit einem Beitrag zur Methodik der Kultur mariner Hydroiden. *Helgoländer wiss. Meeresunters.*, **18**, 136-168.
- WERNER, B. (1970a). Weitere Untersuchungen über die Entwicklungsgeschichte von *Stephanoscyphus* (Scyphozoa, Coronatae) und seine Bedeutung für die Evolution der Scyphozoa. *Verh. dt. zool. Ges. Würzburg 1969, Zool. Anz.*, **33** (Suppl.), 159-165.
- WERNER, B. (1970b). Contribution to the evolution in the genus *Stephanoscyphus* (Scyphozoa, Coronatae) and ecology and regeneration qualities of *Stephanoscyphus racemosus*. *Publ. Seto mar. biol. Lab.*, **18**, 1-20.
- WERNER, B. (1971). *Stephanoscyphus planulophorus* n. spec., ein neuer Scyphopolyp mit einem neuen Entwicklungsmodus. *Helgoländer wiss. Meeresunters.*, **22**, 120-140.
- WERNER, B. (1973a). Spermatozeugmen und Paarungsverhalten bei *Tripedalia cystophora* (Cubomedusae). *Mar. Biol.*, **18**, 212-217.
- WERNER, B. (1973b). New investigations on systematics and evolution of the class Scyphozoa and the phylum Cnidaria. *Publ. Seto mar. biol. Lab.*, **20**, 35-61.
- WERNER, B. (1974). *Stephanoscyphus eumedusoides* n. spec. (Scyphozoa, Coronatae), ein Höhlenpolyp mit einem neuen Entwicklungsmodus. *Helgoländer wiss. Meeresunters.*, **26**, 434-463.
- WERNER, B. (1975). Bau und Lebensgeschichte des Polypen von *Tripedalia cystophora* (Cubozoa, class. nov., Carybdeidae) und seine Bedeutung für die Evolution der Cnidaria. *Helgoländer wiss. Meeresunters.*, **27**, 461-504.
- WERNER, B., CUTRESS, C. E. and STUDEBAKER, J. P. (1971). Life cycle of *Tripedalia cystophora* CONANT (Cubomedusae). *Nature, Lond.*, **232**, 582-583.
- WERNER, E. (in press). Preliminary experiments and feasibility studies on holothurian (sea cucumber) mariculture. In G. Persoone and E. Jaspers (Eds), *Tenth European Marine Biology Symposium*. Ostend, Belgium, 1975.
- WEST, D. L. and RENSHAW, R. W. (1970). The life-cycle of *Clytia attenuata*. (Calyptoblastea: Campanulariidae). *Mar. Biol.*, **7**, 332-339.
- WESTERNHAGEN, H. VON (1973a). A preliminary study on the food preferences of *Siganus concatenata* (CUVIER and VALENCIENNES). *Philipp. J. Sci.*, **10**, 61-73.
- WESTERNHAGEN, H. VON (1973b). The natural food of the rabbitfish *Siganus oramin* and *S. striolata*. *Mar. Biol.*, **22**, 367-370.
- WESTERNHAGEN, H. VON (1974a). Food preferences in cultured rabbitfishes (Siganidae). *Aquaculture*, **3**, 109-117.
- WESTERNHAGEN, H. VON (1974b). Rearing *Siganus striolata* in a closed seawater system. *Aquaculture*, **4**, 97-98.
- WESTERNHAGEN, H. VON and DETHLEFSEN, V. (1975). Combined effects of cadmium and salinity on development and survival of flounder eggs. *J. mar. biol. Ass. U.K.*, **55**, 945-957.
- WESTERNHAGEN, H. VON, DETHLEFSEN, V. and ROSENTHAL, H. (1975). Combined effects of cadmium and salinity on development and survival of garpike eggs. *Helgoländer wiss. Meeresunters.*, **26**, 416-433.
- WESTERNHAGEN, H. VON and ROSENTHAL, H. (1975). Rearing and spawning siganids (Pisces: Teleostei) in a closed seawater system. *Helgoländer wiss. Meeresunters.*, **27**, 1-18.
- WESTERNHAGEN, H. VON and ROSENTHAL, H. (1976). Predator-prey relationship between Pacific herring, *Clupea harengus pallasi*, larvae and a predatory hyperiid amphipod, *Hyperoche medusarum*. *Fish. Bull. U.S.*, **74**, 669-674.

- WESTERNHAGEN, H. VON, ROSENTHAL, H. and SPERLING, K. R. (1974). Combined effects of cadmium and salinity on development and survival of herring eggs. *Helgoländer wiss. Meeresunters.*, **26**, 416-433.
- WEYMOUTH, F. W., LINDNER, M. J. and ANDERSON, W. W. (1933). Preliminary report on the life history of the common shrimp *Penaeus setiferus* (LINN.). *Bull. U.S. Bur. Fish.*, **48**, 1-26.
- WHITE, G. C. (1972). *Handbook of Chlorination*, Van Nostrand Reinhold Co., New York.
- WHITE, J. R. (1970). Thiamine deficiency in an Atlantic bottle-nosed dolphin (*Tursiops truncatus*) on a diet of raw fish. *J. Am. vet. med. Ass.*, **157**, 559-562.
- WHITELOCK, O. v. St. (Ed.) (1959). Axenic culture of invertebrate Metazoa: A goal. *Ann. N.Y. Acad. Sci.*, **77**, 25-406.
- WHITNEY, D. D. (1907). Determination of sex in *Hydatina senta*. *J. exp. Zool.*, **5**, 1-26.
- WHITNEY, D. D. (1914a). The production of males and females controlled by food conditions in *Hydatina senta*. *Science, N.Y.*, **39**, 832-833.
- WHITNEY, D. D. (1914b). The influence of food in controlling sex in *Hydatina senta*. *J. exp. Zool.*, **17**, 545-558.
- WHITNEY, D. D. (1915). The production of males and females controlled by food conditions in the English *Hydatina senta*. *Biol. Bull. mar. biol. Lab., Woods Hole*, **29**, 41-45.
- WHITNEY, D. D. (1916). The control of sex by food in five species of rotifers. *J. exp. Zool.*, **20**, 263-296.
- WHITNEY, D. D. (1917). The relative influence of food and oxygen in controlling sex in rotifers. *J. exp. Zool.*, **24**, 101-138.
- WHITNEY, D. D. (1919). The ineffectiveness of oxygen as a factor in causing male-production in *Hydatina senta*. *J. exp. Zool.*, **28**, 469-492.
- WHITNEY, D. D. (1929). Male production in crowded and uncrowded cultures of the rotifer *Hydatina senta*. *Physiol. Zool.*, **2**, 269-274.
- WHITTAKER, R. H. and FEENEY, P. P. (1971). Allelochemics: Chemical interactions between species. *Science, N.Y.*, **171**, 757-770.
- WHITTLE, K. J. and BLUMER, M. (1970a). A predator-prey relationship. Sea stars-bivalves. The chemical basis of the response of *Asterias vulgaris* to *Crassostrea virginica*. *Tech. Rep. Woods Hole oceanogr. Instrn.*, **70/20**.
- WHITTLE, K. J. and BLUMER, M. (1970b). Interaction between organisms and dissolved substances in the sea. Chemical attraction of starfish *Asterias vulgaris* to oysters. In D. W. Hood (Ed.), *Organic Matter in Natural Waters*. Alaska Institute of Marine Sciences, Alaska. pp. 495-509.
- WHITTOW, G. C., MATSUURA, D. T. and LIN, Y. C. (1970). Responses of the California sea lion to different environmental temperatures. *Physiologist, Wash.*, **13**, 339.
- WHITTOW, G. C., MATSUURA, D. T. and LIN, Y. C. (1972). Temperature regulation in the California sea lion (*Zalophus californianus*). *Physiol. Zool.*, **45**, 68-77.
- WHITTOW, G. C., MATSUURA, D. T. and OHATA, C. A. (1975). Physiological and behavioural temperature regulation in the California sea lion (*Zalophus californianus*). *Rapp. P.-v. Réun. Cons. int. Explor. Mer*, **169**, 479-480.
- WICHTERMAN, R. (1967). Mating types, breeding system, conjugation and nuclear phenomena in the marine ciliate *Euplotes cristatus* KAHL from the Gulf of Naples. *J. Protözoöl.*, **14**, 49-58.
- WICKINS, J. F. (1972). The food value of brine shrimp, *Artemia salina* L., to larvae of the prawn, *Palaemon serratus* PENNANT. *J. exp. mar. Biol. Exp.*, **10**, 151-170.
- WICKINS, J. F. and BEARD, T. W. (1974). Observations on the breeding and growth of the giant freshwater prawn *Macrobrachium rosenbergii* (DE MAN) in the laboratory. *Aquaculture*, **3**, 159-174.
- WIESER, W. (1953). Die Beziehung zwischen Mundhöhlengestalt, Ernährungsweise und Vorkommen bei freilebenden marinen Nematoden. *Ark. Zool.*, **4**, 439-484.
- WIESER, W. (1959). Free-living marine nematodes. IV. General Part. *Acta Univ. lund.*, **55**, 1-109.
- WIESER, W. (1960). Benthic studies in Buzzards Bay. II. The meiofauna. *Limnol. Oceanogr.*, **5**, 121-137.
- WIESER, W. and KANWISHER, J. (1960). Growth and metabolism in a marine nematode, *Enoplus communis* BASTIAN. *Z. vgl. Physiol.*, **43**, 29-36.

- WIESER, W. and KANWISHER, J. (1961). Ecological and physiological studies on marine nematodes from a small salt marsh near Woods Hole, Massachusetts. *Limnol. Oceanogr.*, **6**, 262-271.
- WILBER, C. G. (1972). Turbidity: Animals. In O. Kinne (Ed.), *Marine Ecology*, Vol. I, Environmental Factors, Part 2. Wiley, London. pp. 1181-1189.
- WILCKE, D. E. (1952). Beobachtungen über den Bau und die Funktion des Röhren- und Kammersystems der *Pectinaria koreni* MALMGREN. *Helgoländer wiss. Meeresunters.*, **4**, 130-137.
- WILKE, F. (1957). Food of sea otters and harbor seals at Amchitka Island. *J. Wildl. Mgmt.*, **21**, 241-242.
- WILKE, F. and KENYON, K. W. (1952). Notes on the food of fur seal, sea lion and harbor porpoise. *J. Wildl. Mgmt.*, **16**, 396-397.
- WILKIE, D. W., BELL, G. B. and COLES, J. S. (1968). A method of dolphin transport and its physiological evaluation. *Int. Zoo Yb.*, **8**, 198-202.
- WILKINS, N. P. (1967). Starvation of the herring, *Clupea harengus* L.: survival and some gross biochemical changes. *Comp. Biochem. Physiol.*, **23**, 506-518.
- WILLIAMS, B. G. (1968). Laboratory rearing of the larval stages of *Carcinus maenas* (L.) (Crustacea: Decapoda). *J. nat. Hist.*, **2**, 121-126.
- WILLIAMS, L. W. (1904). Lobster culture. *32nd Rep. Rhode Isl. Commrs inld Fish.*, 35-53, 57-85.
- WILLIAMSON, D. I. (1972). Larval development in a marine and a freshwater species of *Macrobrachium* (Decapoda, Palaemonidae). *Crustaceana*, **23**, 282-298.
- WILLIAMSON, H. C. (1901). On the larval stages of decapod Crustacea. The shrimp (*Crangon vulgaris* FABR.). *Ann. Rep. Fish. Bd Scotl.*, **19**.
- WILSON, D. P. (1929). The larvae of the British sabellarians. *J. mar. biol. Ass. U.K.*, **15**, 221-269.
- WILSON, D. P. (1932). The development of *Nereis pelagica* LINNAEUS. *J. mar. biol. Ass. U.K.*, **18**, 203-217.
- WILSON, D. P. (1941). Oyster rearing on the River Yealm. *J. mar. biol. Ass. U.K.*, **25**, 125-127.
- WILSON, D. P. (1951). A biological difference between natural sea water. *J. mar. biol. Ass. U.K.*, **30**, 1-26.
- WILSON, D. P. (1952). The influence of the nature of the substratum on the metamorphosis of the larvae of marine animals, especially of *Ophelia bicornis* SAVIGNY. *Annls Inst. océanogr., Monaco*, **27**, 49-156.
- WILSON, D. P. (1953a). The settlement of *Ophelia bicornis* SAVIGNY larvae. The 1951 experiments. *J. mar. biol. Ass. U.K.*, **31**, 413-438.
- WILSON, D. P. (1953b). The settlement of *Ophelia bicornis* SAVIGNY larvae. The 1952 experiments. *J. mar. biol. Ass. U.K.*, **32**, 209-233.
- WILSON, D. P. (1954). The attractive factor in the settlement of *Ophelia bicornis* SAVIGNY. *J. mar. biol. Ass. U.K.*, **33**, 361-380.
- WILSON, D. P. (1955). The role of micro-organisms in the settlement of *Ophelia bicornis* SAVIGNY. *J. mar. biol. Ass. U.K.*, **34**, 531-543.
- WILSON, D. P. (1968a). Long-term effects of low concentrations of an oil-spill remover ('detergent'): studies with the larvae of *Sabellaria spinulosa*. *J. mar. biol. Ass. U.K.*, **48**, 177-182.
- WILSON, D. P. (1968b). Temporary adsorption on a substrate of an oil-spill remover ('detergent'): tests with larvae of *Sabellaria spinulosa*. *J. mar. biol. Ass. U.K.*, **48**, 183-186.
- WILSON, D. P. and ARMSTRONG, F. A. J. (1952). Further experiments on biological differences between natural sea water. *J. mar. biol. Ass. U.K.*, **31**, 335-349.
- WILSON, E. A. (1907). Weddell's seal. *Mammalia*, **2**, 1-66. (*Nat'l. Antarctic Exped. 1901-04.*)
- WILSON, H. V. (1907). A new method by which sponges may be artificially reared. *Science, N.Y.*, **25**, 912.
- WILSON, H. V. (1908). Development of sponges from tissue cells outside the body of the parent. *Bull. Bur. Fish., Wash.*, **28**, 1265-1271.
- WILSON, H. V. (1910). Development of sponges from dissociated tissue cells. *Bull. Bur. Fish., Wash.*, **30**, 3-30.
- WILSON, H. V. (1937). Notes on the cultivation and growth of sponges from reduction bodies,

- dissociated cells, and larvae. In J. G. Needham (Ed.), *Culture Methods for Invertebrate Animals*, Comstock Publishing Co., New York. pp. 137-139.
- WILSON, K. W. (1972). Toxicity of oil-spill dispersants to the embryos and larvae of some marine fish. In M. Ruivo (Ed.), *Marine Pollution and Sea Life*. Fishing News (Books), London. pp. 318-322.
- WILSON, K. W. (1974). The ability of herring and plaice larvae to avoid concentrations of oil dispersants. In J. H. S. Blaxter (Ed.), *The Early Life History of Fish*. Springer-Verlag, Berlin. pp. 589-602.
- WILSON, T. M. (1966). Behavior and husbandry methods for captive northern fur seal pups. M.S. Thesis, Cornell University, New York.
- WILTZIUS, W. J. (1973). Selected bibliography on the collection, fertilization, vitality, storage and cryopreservation of gametes—particularly salmonids. *Colo. Dep. Nat. Resour., Fish. Inf. Leafl.*, **23**, 1-4.
- WINTER, J. E. (1969). Über den Einfluß der Nahrungskonzentration und anderer Faktoren auf Filtrierleistung und Nahrungsausnutzung der Muscheln *Arctica islandica* und *Modiolus modiolus*. *Mar. Biol.*, **4**, 87-135.
- WINTER, J. E. (1970). Filter feeding and food utilization in *Arctica islandica* L. and *Modiolus modiolus* L. at different food concentrations. In J. H. Steele (Ed.), *Marine Food Chains*. University of California Press, Berkeley. pp. 196-206.
- WINTER, J. E. (1973). The filtration of *Mytilus edulis* and its dependence on algal concentration, measured by a continuous automatic recording apparatus. *Mar. Biol.*, **22**, 317-328.
- WINTER, J. E. (in press). Feeding experiments with *Mytilus edulis* L. at small laboratory scale. Part II. The influence of suspended silt in addition to algal suspensions on growth. In G. Persoone and E. Jaspers (Eds), *Tenth European Marine Biology Symposium*. Ostend, Belgium, 1975.
- WINTER, J. E. and LANGTON, R. W. (in press). Feeding experiments with *Mytilus edulis* L. at small laboratory scale. I. The influence of the total amount of food ingested and food concentration on growth. In G. Persoone and E. Jaspers (Eds), *Tenth European Marine Biology Symposium*. Ostend, Belgium, 1975.
- WISELY, B. (1958). The development and settling of a serpulid worm, *Hydroides norvegica* GUNNERUS (Polychaeta). *Aust. J. Freshwat. Res.*, **9**, 351-361.
- WISELY, B. (1960). Experiments on rearing the barnacle *Elminius modestus* DARWIN to the settling stage in the laboratory. *Aust. J. mar. Freshw. Res.*, **11**, 42-54.
- WITTING, L. A. and HORWITT, M. K. (1964). Effects of dietary selenium, methionine, fat level and tocopherol on rat growth. *J. Nutr.*, **84**, 351-360.
- WOELKE, C. E. (1966). Bioassay with bivalve larvae. *Rep. Pacif. mar. Fish. Commn.*, **18**, 33-35.
- WOOD, E. M. (1953). A century of American fish culture, 1853-1953. *Proqve Fish Cult.*, **15**, 147-162.
- WOOD, F. G. (1973). *Marine Mammals and Man—The Navy's Porpoises and Sea Lions*, Robert B. Luce, Washington.
- WOOD, F. G. and RIDGWAY, S. H. (1967). Project SEALAB Report; SEALAB II Project group. Office of Naval Research, Washington, D.C.
- WOOTTON, D. (1949). The development of *Thyonepsolus nutriens*. Ph.D. Thesis, Stanford University, Stanford.
- WORMHOUDT, A. VAN and CECCALDI, J. (in press). Influence of the light quality in intensive culture of *Palaemon serratus* PENNANT. In G. Persoone and E. Jaspers (Eds), *Tenth European Marine Biology Symposium*. Ostend, Belgium, 1975.
- WÜLKER, G. (1911). Die Technik der Amöbenzüchtung. *Zentbl. Bakt. (Abt. I)*, **50**, 577-610.
- WYTTENBACH, C. R. (1968). The dynamics of stolon elongation in the hydroid *Campanularia flexuosa*. *J. exp. Zool.*, **167**, 333-352.
- WYTTENBACH, C. R. (1969). Genetic variations in the mode of stolon growth in the hydroid *Campanularia flexuosa*. *Biol. Bull. mar. biol. Lab., Woods Hole*, **137**, 547-556.
- WYTTENBACH, C. R., CROWELL, S. and SUDDITH, R. L. (1965). The cyclic elongation of stolons and uprights in the hydroid, *Campanularia*. *Biol. Bull. mar. biol. Lab., Woods Hole*, **129**, 429.
- WYTTENBACH, C. R., CROWELL, S. and SUDDITH, R. L. (1973). Variations in the mode of stolon

- growth among different genera of colonial hydroids and their evolutionary implications. *J. Morphol.*, **139**, 363-375.
- YABLONSKAYA, E. A. (1953). Feeding of *Nereis succinea* in the Caspian Sea. In *Acclimatization of Nereis in the Caspian Sea*. (Russ.) *Mater. Pozn. Faunij Florij SSSR, M.O.I.P., N.S. Zool.*, **33** (48), 285-351.
- YAMADA, M. (1961). Polyp and medusa of *Podocoryme hartlaubii* NEPPI and STIASNY (Hydrozoa) from the Gulf of Naples. *Pubbl. Staz. zool. Napoli*, **32**, 134-143.
- YAMAGUCHI, M. (1973). Early life histories of coral reef asteroids with special reference to *Acanthaster planci*. In O. A. Jones and R. Endean (Eds), *Biology and Geology of Coral Reefs*, Vol. 2, Biology 1. Academic Press, New York. pp. 369-387.
- YAMAGUCHI, M. (1974a). Growth of juvenile *Acanthaster planci* (L.) in the laboratory. *Pacif. Sci.*, **28**, 123-138.
- YAMAGUCHI, M. (1974b). Effect of elevated temperature on the metabolic activity of the coral reef asteroid *Acanthaster planci* (L.). *Pacif. Sci.*, **28**, 139-146.
- YAMAMOTO, K., MORIOKA, T., HIROI, O. and OMORI, M. (1974). Artificial maturation of Japanese eels by the injection of salmonid pituitary. *Bull. Jap. Soc. scient. Fish.*, **40**, 1-7.
- YAMAMOTO, K. and YAMAUCHI, K. (1974). Sexual maturation of Japanese eel and production of eel larvae in the aquarium. *Nature, Lond.*, **251**, 220-222.
- YAMAZAKI, F. (1976). Application of hormones in fish culture. *J. Fish. Res. Bd Can.*, **33**, 948-958.
- YANAGIMACHI, R. (1953). A note on the so-called 'boring movement' of sea urchin spermatozoa. (Jap.) *Zool. Mag., Tokyo*, **62**, 22-26.
- YANAGIMACHI, R. (1961). The use of cetyl alcohol in the rearing of the rhizocephalan larvae. *Crustaceana*, **2**, 37-39.
- YASHOUV, A. (1969). Preliminary report on induced spawning of *Mugil cephalus* (L.) reared in captivity in freshwater ponds. *Bamidgeh*, **21**, 19-24.
- YASUGI, R. (1937). On the free-swimming larvae of *Mitella mitella* L. *Botany Zool., Tokyo*, **5**, 792-796.
- YASUMASU, I. (1958). Hatching enzyme of the sea urchins, *Hemicentrotus pulcherrimus* and *Heliocidaris crassispina*. *Bull. biol. Stn Asamushi*, **9**, 83-84.
- YASUMASU, I. (1961). Crystallization of hatching enzyme of the sea urchin *Anthocidaris crassispina*. *Scient. Pap. Coll. gen. Educ. Tokyo*, **11**, 275-280.
- YASUNAGA, Y. (1971). Studies on the feeding habit and growth of the plaice, *Paralichthys olivaceus*, in the larval stage. *Bull. Tokai Reg. Fish. Res. Lab.*, **68**, 31-43.
- YOKOE, Y. and YASUMASU, I. (1964). The distribution of cellulase in invertebrates. *Comp. Biochem. Physiol.*, **13**, 323-338.
- YONE, Y. and FUJII, M. (1974). Studies on nutrition of red sea bream. 10. Qualitative requirements for water-soluble vitamins. *Rep. Fish. Res. Lab. Kyushu Univ.*, **1974**, 25-32.
- YONE, Y., SAKAMOTO, S. and FURUICHI, M. (1974). Studies on nutrition of Red Sea bream. 9. The basal diet for nutrition studies. *Rep. Fish. Res. Lab. Kyushu Univ.*, **1974**, 13-24.
- YONGE, C. M. (1938). Evolution of ciliary feeding in the Prosobranchia, with an account of feeding in *Capulus ungaricus*. *J. mar. biol. Ass. U.K.*, **22**, 453-468.
- YONGE, C. M. (1949). *The Sea Shore*, Collins, London.
- YONGE, C. M. (1960). The oyster. *New Nat., Spec. Vol.*, **18**.
- YOSHIDA, M. (1952). Some observations on the maturation of the sea-urchin, *Diadema setosum*. *Annotes zool. jap.*, **25**, 265-271.
- YOSHIDA, M. (1966). Photosensitivity. In R. A. Booloottian (Ed.), *Physiology of Echinodermata*. Interscience Publishers, New York. pp. 435-464.
- YOUNG, M. W. (1926). The food and feeding habits of starfishes. *N.Z. Jl Sci. Technol.*, **8**, 282-285.
- YOUNG, S. D. (1971). Organic matrices associated with CaCO₃ skeletons of several species of hermatypic corals. In H. M. Lenhoff, L. Muscatine and L. V. Davis (Eds), *Experimental Coelenterate Biology*. University of Hawaii Press, Honolulu. pp. 260-264.
- ZAFIRIOU, O. (1972). Responses of *Asterias vulgaris* to chemical stimuli. *Mar. Biol.*, **17**, 100-107.
- ZAFIRIOU, O., WHITTLE, K. J. and BLUMER, M. (1972). Response of *Asterias vulgaris* to bivalves and bivalve tissue extracts. *Mar. Biol.*, **13**, 137-145.
- ZAMPETTI-BOSSELER, F., HUEZ, G., and BRACHET, J. (1973). Effects of several inhibitors of

- macromolecule synthesis upon maturation of marine invertebrate oocytes. *Exptl Cell Res.*, **78**, 383-393.
- ZAUGG, W. S. and McLAIN, L. R. (1969). Inorganic salt effects on growth, salt water adaptation, and gill ATPase of Pacific salmon. In J. E. Halver and O. W. Neuhaus (Eds), *Fish in Research*. Academic Press, New York. pp. 293-306.
- ZAWADOWSKY, M. (1916). Delay in the formation of the egg and the determination of sex in *Diglena volvocicola*. *J. Zool. Věst.*, **2**, 287-310.
- ZEIN-ELDIN, Z. P. (1962). Experimental growth studies with postlarval brown shrimp. *Circ. Fish Wildl. Serv., Wash.*, **161**, 61-62.
- ZEIN-ELDIN, Z. P. (1963). Effect of salinity on growth of post-larval penaeid shrimp. *Biol. Bull. mar. biol. Lab., Woods Hole*, **125**, 188-196.
- ZEIN-ELDIN, Z. P. and ALDRICH, D. V. (1965). Growth and survival of postlarval *Penaeus aztecus* under controlled conditions of temperature and salinity. *Biol. Bull. mar. biol. Lab., Woods Hole*, **129**, 199-216.
- ZEIN-ELDIN, Z. P. and GRIFFITH, G. W. (1966). The effect of temperature upon the growth of laboratory-held postlarval *Penaeus aztecus*. *Biol. Bull. mar. biol. Lab., Woods Hole*, **131**, 186-196.
- ZEITOUN, I. H., HALVER, J. E., ULLREY, D. E. and TACK, P. I. (1973). Influence of salinity on protein requirements of rainbow trout (*Salmo gairdneri*) fingerlings. *J. Fish. Res. Bd Can.*, **30**, 1867-1873.
- ZEITOUN, I. H., ULLREY, D. E., HALVER, J. E., TACK, P. I. and MAGEE, W. T. (1974). Influence of salinity on protein requirements of coho salmon (*Oncorhynchus kisutch*) smolts. *J. Fish. Res. Bd Can.*, **31**, 1145-1148.
- ZELNY, C. (1905). The rearing of serpulid larvae with notes on the behavior of the young animals. *Biol. Bull. mar. biol. Lab., Woods Hole*, **8**, 308-312.
- ZENKOVICH, B. A. (1938). Milk of large-sized cetaceans. *Dokl. Akad. Nauk SSSR*, **20**, 203-205.
- ZIEGELMEIER, E. (1952). Beobachtungen über den Röhrenbau von *Lanice conchilega* (PALLAS) im Experiment und am natürlichen Standort. *Helgoländer wiss. Meeresunters.*, **4**, 107-129.
- ZIEGELMEIER, E. (1964). Über die Wohnbau-Form von *Arenicola marina* L. (Freilegen von Gängen *in situ* mit Hilfe eines Stechkastens). *Helgoländer wiss. Meeresunters.*, **11**, 157-160.
- ZIEGELMEIER, E. (1969a). Neue Untersuchungen über die Wohnröhren-Bauweise von *Lanice conchilega* (Polychaeta, Sedentaria). *Helgoländer wiss. Meeresunters.*, **19**, 216-229.
- ZIEGELMEIER, E. (1969b). Wohnröhrenbauweise von *Lanice conchilega* (Polychaeta, Sedentaria). *Zool. Anz. (Suppl.)*, **33**, 639-642.
- ZILLIOUX, E. J. (1968). Ingestion and assimilation in *Acartia*. *31st A. Mtg Am. Soc. Limnol. Oceanogr.*, **1968**.
- ZILLIOUX, E. J. (1969a). A continuous recirculating culture system for planktonic copepods. *Mar. Biol.*, **4**, 215-218.
- ZILLIOUX, E. J. (1969b). In J. D. Costlow (Ed.), *Marine Biology*. V. In *Proceedings of the Fifth Interdisciplinary Conference on Marine Biology*. Gordon and Breach, New York.
- ZILLIOUX, E. J., FOULK, H. R., PRAGER, J. C. and CARDIN, J. A. (1973). Using *Artemia* to assay oil dispersant toxicities. *J. Wat. Pollut. Control Fed.*, **45**, 2389-2396.
- ZILLIOUX, E. J. and GONZALEZ, J. G. (1972). Egg dormancy in a neritic calanoid copepod and its implications to overwintering in boreal waters. In B. Battaglia (Ed.), *Fifth European Marine Biology Symposium*, Venice. Piccin Editore, Padova. pp. 217-230.
- ZILLIOUX, E. J. and WILSON, D. F. (1964). On the survival and propagation of *Acartia tonsa* in laboratory culture. *27th Annual Meeting Am. Soc. Limnol. Oceanogr.* Miami Beach, Fla., 1964.
- ZILLIOUX, E. J. and WILSON, D. F. (1966). Culture of a planktonic calanoid copepod through multiple generations. *Science, N. Y.*, **151**, 996-998.
- ZIMMERMANN, M. A. and McCLEAVE, J. D. (1975). Orientation of elvers of American eels (*Anguilla rostrata*) in weak magnetic and electric fields. *Helgoländer wiss. Meeresunters.*, **27**, 175-189.
- ZIMMERMAN, S. T. (1973). The transformation of energy by *Lucifer chacei*. *Pacif. Sci.*, **27**, 247-259.
- ZSCHIECHE, A. (1909). Untersuchungen über die Metamorphose von *Alcyonidium mytili*. *Zool. Jb. (Anat. Ontogenie Tiere)*, **28**, 1-72.

AUTHOR INDEX

Numbers in italics refer to those pages on which the author's work is stated in full.

- AARONSON, S., 590, 601, *1166, 1168*
ABDERHALDEN, E., 584, *1124*
ABE, I., 1018, *1126*
ABE, N., 662, *1124*
ACKMAN, R. G., 1114, *1124*
ADACHI, R., 679, 685, 686, *1124*
ADAMS, C. A., 1005, *1124, 1137*
ADAMS, J. A., 791, *1124*
ADELUNG, D., 875, *1146*
ADRON, J. W., 980, 1013-1015, 1017, *1124, 1142*
AI, T., 898, 899, *1124*
AIZAWA, Y., 858, *1124*
ÅKESSON, B., 729-731, 736, *1124*
AKIMUSHKIN, I. I., 1108, *1124*
ALBERTINI-BERHAUT, J., 1007, *1124*
ALBERTS, J., 628, *1171*
ALBRECHT, M.-L., 1009, *1124*
ALCOCK, A., 950, 951, *1124*
ALDERDICE, D. F., 969, 970, 1033, *1125, 1205*
ALDRICH, D. V., 857, *1229*
ALLEMAND, A., 632, 638, *1125*
ALLEN, D. M., 857, *1141*
ALLEN, E. J., 584, 770, 940-942, *1125*
ALLEN, P. G., 870, *1208*
ALVING, T., 1107, *1125*
AMANO, K., 1083, *1125*
AMBACHE, N., 966, *1125*
AMOROSO, E. C., 1103, 1117, 1119, *1125*
AMUNDIN, M., 1060, *1125*
ANCONA LOPEZ, A. A., 966, *1207*
ANDERLINI, V. C., 1120, *1187*
ANDERSEN, H. T., 1053, *1125*
ANDERSEN, S. H., 1042, 1044, 1052, 1058, 1060-1062, 1065, 1069, 1072, 1075, 1078-1081, 1089, 1090, 1092, 1110, 1113, *1125*
ANDERSON, E. D., 758, *1125*
ANDERSON, J. M., 944, 948, 950, 952, 954, *1125*
ANDERSON, W. W., 858, *1181, 1225*
ANDREWS, J. W., 824, 833, 834, 836, 882, 1019, *1125, 1211*
ANDREWS, P. M., 962, *1137*
ANEMIYA, I., 1093, *1125*
ANGER, K., 723, *1127*
ANICETE, B., 956, *1139*
ANONYMOUS, 583, 1028, 1068, *1125*
ANRAKU, M., 767, 791, 795, *1126*
AOE, H., 1018, *1126*
AOKI, M., 765, *1169*
APELT, G., 668, 669, 671, 674-678, *1126*
APPEL, Z., 701, 708, 712, *1172*
APPELLÖF, A., 661, *1126*
ARAI, S., 1015, 1017, 1018, *1126, 1162*
ARANA, M. F., 843, *1126*
ARMSTRONG, F. A. J., 965, *1226*
ARNDT, A., 591, *1126*
ARNDT, E. A., 651, 656, 657, *1126*
ARNDT, W., 630, 637, 638, *1126*
ARNOLD, Z. M., 596, 597, 599, *1126*
ARONSON, M., 965, *1191*
ARSENIYEV, V. A., 1097, *1126*
ARTHUR, D. K., 981, *1126*
ARVIDSSON, J., 952, *1150*
ARVY, L., 1111, *1126*
ASHLEY, L. M., 1017, *1126*
ASHWORTH, U. S., 1103, 1105, *1126*
ASPER, E. D., 1037, 1040, 1041, 1107, *1126, 1135*
ATEMA, J., 580, *1126*
ATKINSON, C., 954, *1126*
ATODA, K., 662, *1127*
ATZ, J. W., 968, 990, 1023, 1028, 1076, *1127, 1139, 1198*
AUBERT, M., 616, *1127*
AUGUSTIN, A., 723, *1127*
AURICH, H., 584, *1175*
AUSTIN, W., 954, *1127*
AYLING, A. M., 801, *1127*
AYMES, Y., 715, *1127*
BAAB, J. S., 582, *1127*
BAADE, R. T., 1093, 1095, *1187*
BAAS BECKING, L. G. M., 745, *1127, 1132, 1170*
BABENKO, V. V., 1075, *1127*
BACCI, G., 731, 956, *1127*
BACKHOUSE, K. M., 1065, *1127*
BACQ, Z. M., 965, *1127*
BAE, G. M., 930, *1127*
BAHAMONDE, N., 879, *1127*
BAHN, C. H., 1075, *1169*
BAILEY, R. E., 1060, *1128*
BAINES, G. A., 1093, 1095, 1096, *1150*
BAKER, A. DE C., 809, 810, *1128*
BAKER, B. E., 1103, 1112, *1141, 1179*
BAKER, H., 590, 620, *1168*
BAKER, W. F., 634, *1159*
BALAZS, G. H., 824, 837, *1128*
BALBONTIN, F., 1017, *1132*
BALL, G. T., 1017, *1142*
BALLWEG, R. F., 602, *1202*

- BANG, K. S., 853, *1128*
 BANK, O., 1008, *1128*
 BAPTIST, G., 836, *1211*
 BAPTIST, G. J., 824, *1125*
 BARBOUR, M. L., 1097, *1171*
 BARDACH, J. E., 845, 846, 855, 859, 871, 873,
 886, 889, 895, 896, 902, 924, 931, 933, 1005,
 1006, 1009-1012, 1020, *1128*
 BAREN, C. F., 589, 622, *1157*
 BARKER, H. A., 591, 622, *1128*
 BARNABÉ, G., 621, *1128*
 BARNARD, J. L., 736, *1202*
 BARNES, C. D., 655, *1223*
 BARNES, E. W., 859, *1128*
 BARNES, H., 728, 742, 786, 802, 804-806,
1128, 1176
 BARNES, M., 802, 804, 805, *1128*
 BARNES, R. D., 813, *1128*
 BARR, M. W., 765, 769, 789, *1128*
 BARRET, I., 976, 978, *1176*
 BARRETT, L., 949, 950, *1184*
 BARTHOLOMEW, G. A. (JR.), 1074, 1117-1119,
1128, 1129, 1198
 BARTMANN, W., 1077, 1090, 1108, *1129*
 BASSINDALE, R., 799, *1129*
 BATHAM, E. J., 799, *1129*
 BATTAGLIA, B., 765, 766, 777, 789, *1129*
 BAUER, J. C., 954, *1190*
 BAUGHMAN, J. L., 901, *1129*
 BAWAB, F. M., 857, *1186*
 BAYNE, B. L., 919, 924, *1129*
 BAZIRE, M., 686, *1129*
 BEARD, T. W., 833, 844, 848, *1152, 1225*
 BEARDEN, C. M., 858, *1184*
 BEATTY, R. A., 1031, *1129*
 BEAUCHAMP, M. P., 734, *1129*
 BEAUCHAMP, P. DE, 679, *1129*
 BEAUMONT, A. R., 903, 925, 926, *1159*
 BECHER, S., 957, *1129*
 BEDFORD, F. P., 949, *1129*
 BEER, G. R. DE, 642, 659, *1129, 1168*
 BEKLEMISHEV, K. V., 728, *1129*
 BELAR, K., 592, *1129*
 BELCHEVA, R., 1031, *1220*
 BELL, G. B., 1045-1047, *1226*
 BELLAN, G., 736, *1130*
 BELYAEVA, V. N., 1031, *1204*
 BENAYOUN, G., 934, *1152*
 BENCHLEY, F. J., 1102, *1130*
 BENIJTS, F., 744, 745, 759, 761, *1130, 1213*
 BENNETT, E. W., 949, 951, *1130*
 BENNETT, J., 950, 955, *1149*
 BENOIT, D., 758, *1130*
 BENOIT, P., 661, *1130*
 BEN-TUVIA, A., 1007, *1130*
 BERGER, W. H., 600, *1204*
 BERGH, W. VAN DEN, 1068, *1130*
 BERGQUIST, P. R., 631, 635, *1130*
 BERHAUT, J., 1013, *1219*
 BERNARD, M., 777, *1130*
 BERNHARD, M., 964, 965, *1130*
 BERRILL, N. J., 652, 654, 659-661, *1130, 1144*
 BERTRAM, G. C. L., 1097, 1098, 1117, 1118,
1130
 BERTRAM, R., 620, *1131*
 BERTRAND, E., 1028, *1152*
 BETOUHIM-EL, T., 789, *1130*
 BEUTLER, R., 661, *1131*
 BHATTACHARYYA, R. N., 981, *1131*
 BICK, H., 620, *1131*
 BIDDER, H. P., 630, *1131*
 BIERBACH, M., 651, 658, *1131*
 BIÉTRIX, E., 971, 976-978, *1149*
 BIGEJ, R. G., 1022, *1140*
 BIGG, M. A., 1041, *1131*
 BIRKY, C. W., 685, 690, 691, *1131*
 BISHAI, H. M., 976-978, *1131*
 BISHOP, J. L., 917, *1192*
 BLAIR, A., 980, 1013-1015, *1124, 1142*
 BLAXTER, J. H. S., 969, 970, 976-978, 981,
 982, 986, 987, 989, 991, 994, 996-998, 1017,
 1021, 1029, 1030, *1131, 1132*
 BLEGVAD, H., 725, 726, 728, 949-951, *1132*
 BLOUNT, R. F., 737, *1132*
 BLUMER, M., 966, *1225, 1228*
 BLUNDO, C. M., 857, *1183*
 BOAS, J. E. V., 886, *1132*
 BOCQUET, C., 765, 766, *1132*
 BOGOMOLOVA, E. M., 991, *1132*
 BOGUCKI, M., 726, *1132*
 BOND, R. M., 744, 747, 763, 770, *1132*
 BONNET, B., 1013, *1219*
 BONNOT, P., 1096, *1132*
 BOOKHOUT, C. G., 760, 799, 803, 874, 883,
1132, 1142
 BOOLOOTIAN, R. A., 937, 950, 955, 957, 960,
1132, 1149, 1156, 1158
 BOONE, E., 745, *1132*
 BORJA, P. C., 856, *1132*
 BOROJEVIC, R., 633, *1132*
 BORTESI, O., 731, *1127*
 BOSCHMA, H., 661, 956, *1132*
 BOTSFORD, L. W., 870, 883, *1132, 1201, 1208*
 BOUCHER, J., 761, *1206*
 BOUGIS, P., 942, *1132*
 BOURNE, G. H., 1117, 1119, *1125*
 BOVERI, T., 938, *1132, 1133*
 BOWBEER, A., 859, 870, *1133*
 BOYD, J., 748, *1133*
 BOYDEN, C. R., 934, *1133*
 BOYER, B. C., 669, *1133*
 BRACHET, J., 955, *1228*

- BRADSHAW, J. S., 596, 597, *1133*
 BRAEKKAN, O. R., 1085, *1133*
 BRAEM, F., 713, *1133*
 BRAFIELD, A. E., 728, *1174*
 BRAND, T. VON, 728, *1133*
 BRANDL, Z., 785, *1133*
 BRANHAM, J. M., 952, *1133*
 BRAUER, R. M., 966, *1133*
 BRAUM, E., 996, *1133*
 BRAVERMAN, M. H., 651, 652, 660, *1133*
 BREDER C. M., 990, 1021, *1133*
 BREESE, W. P., 927, *1133*
 BREITSPRECHER, B., 1009, *1124*
 BRÉLAND, K., 1059, *1134*
 BRÉLAND, M., 1059, *1134*
 BRENKO, M. HRS., 906, *1134*
 BRENNER, M., 582, *1215*
 BRERETON, A., 934, *1134*
 BRETT, G. R., 970, *1125*
 BRETT, J. R., 1004, 1019, 1021, *1134*
 BRICK, R. W., 879, *1134*
 BRIEN, P., 627, *1134*
 BRIGHTWELL, L. R., 726, 1054, *1134*
 BRINCKMANN, A., 651, *1134*
 BRINCKMANN-VOSS, A., 651, *1164*
 BROAD, A. C., 817-819, 849-851, 856, *1134*,
1167
 BROCK, M. A., 651, 655, *1134*
 BRODY, B., 735, *1146*
 BROEKEMA, M. M. M., 841, *1134*
 BROOKS, E. R., 771-773, 783-786, 791, 794,
1191, *1192*
 BROOKS, J. W., 1096, *1134*
 BROOKS, W. K., 841, *1134*
 BROOM, J. G., 855, 856, *1134*, *1213*
 BROWN, A., 728, *1141*
 BROWN, A., JR., 853, *1135*
 BROWN, C., 917, *1135*, *1192*
 BROWN, D. H., 1038, 1049, 1053, 1093, 1107,
1121, *1135*
 BROWN, R. D., 665, 744, 745, 748, 755, 756,
1180
 BROWN, R. N. R., 950, 951, 1098, *1135*, *1211*
 BROWN, W. D., 1083, *1135*
 BROWNE, E. T., 650-654, *1135*
 BRUUN, A. F., 950, *1135*
 BRYAN, P. G., 1007, *1135*, *1218*
 BUCHAL, G., 659, 666, *1191*
 BUCHANAN, J. B., 954, *1135*
 BUCHNER, H., 679, 684, 685, 690, 691, *1135*
 BUDD, P. L., 976, 977, *1135*
 BUDDENBROCK, W. VON, 722, *1135*
 BÜCKMANN, A., 977, 978, *1136*
 BUHR, K.-J., 725, *1136*
 BULL, H. O., 950, 951, 954, *1136*
 BULLIVANT, J. S., 717, *1136*
 BULNHEIM, H.-P., 584, *1175*
 BURDEN, P., 1077, *1149*
 BURGESS, K., 1054, 1088, *1136*
 BURKHOLDER, P. R., 616, *1136*
 BURLA, H., 945, *1136*
 BURNETT, A. L., 952, *1136*
 BURROWS, R. E., 1022, *1140*
 BUSCH, F. C., 1016, *1154*
 BUTENANDT, A., 616, *1173*
 BUTLER, D. P., 583, 836, *1188*
 BUTLER, T. H., 879, *1136*
 BUTTON, C. E., 1061, *1182*
 BUZNIKOV, G. A., 970, *1136*
 CACES, P. B., 856, *1136*
 CAIN, T. D., 906, *1136*
 CAIRNS, J., JR., 620, *1206*
 CALABRESE, A., 905, 906, 934, *1134*, *1136*,
1144
 CALDER, D. R., 644-646, *1136*
 CALDWELL, D. K., 1035, 1036, 1056, 1118,
1121, *1136*
 CALDWELL, M. C., 1035, 1036, 1059, 1118,
1121, *1136*
 CALLAMAND, O., 1028, *1152*
 CALVIN, J., 959, *1203*
 CAMBELL, K., 1028, *1136*
 CAMERON, R. A., 942, *1136*
 CAMPBELL, R. D., 652, *1136*, *1137*
 CAMPBELL, R. J., 583, 833, 915, *1172*
 CANAGARATNAM, P., 1016, *1137*
 CANSDALE, G., 1076, 1087, *1137*
 CARBINE, W. P., 1006, *1137*
 CARCELES, A., 949, *1137*
 CARDIN, J. A., 747, *1229*
 CARLISLE, J. G., JR., 889, 898, *1137*
 CARLUCCI, A. F., 612, *1137*
 CARR, W. E. S., 1005, *1137*
 CARRICK, R., 1117, 1119, 1120, *1137*
 CARRIKER, M. R., 914, *1137*
 CARUELLE, F., 736, *1130*
 CASTAGNA, M., 582, 919, *1137*, *1215*
 CASTILLA, J. C., 966, *1137*
 CASTRO, P., 945, *1137*
 CAWTHORN, M. W., 1108, *1154*
 CAZAUX, C., 734, *1137*
 CECCALDI, J., 848, *1227*
 CEFALU, R. C., 697, 704, 706, 710-712, *1167*,
1188
 CELLARIUS, O., 1027, *1188*
 CHAET, A. B., 961, 962, 965, *1137*, *1138*, *1162*,
1187
 CHAMBERS, E. L., 940, *1138*
 CHAMBERS, R., 940, *1138*
 CHANG, S. L., 595, 596, *1138*
 CHANG, T. M. S., 583, *1138*

- CHANLEY, M. H., 867, *1138*
 CHANLEY, P. E., 901, 911, 913, 916, *1138, 1183*
 CHANLY, H. M., 584, *1212*
 CHAO, L. N., 1005, *1138*
 CHAPMAN, D. G., 1117, 1120, *1174*
 CHAPMAN, S. S., 652, *1138*
 CHAPSKII, K. K., 1117, *1138*
 CHASE, F. A., JR., 813, *1222*
 CHATTON, E., 592, *1138*
 CHAYANOVA, L. A., 785, *1138*
 CHEN, T. P., 1006, *1138*
 CHERBONNIER, G., 957, *1138*
 CHESHER, R. H., 952, *1138*
 CHEUNG, T. S., 846, *1138*
 CHEVREUX, E., 726, *1138*
 CHEW, K., 930, *1223*
 CHIA, F. S., 663, 958, *1138*
 CHIDAMBARAM, K., 1006, *1138*
 CHING-MING, K., 1007, *1210*
 CHIPPERFIELD, P. N. J., 898, *1138*
 CHITTLEBOROUGH, R. G., 883, *1138*
 CHITWOOD, B. G., 685, 691, 696, 698, 700,
 702, 704, 710, 711, *1138, 1146*
 CHITWOOD, M. B., 691, *1138*
 CHOE, S., 854, 948, *1139*
 CHOUDHURY, P. C., 842, 843, *1139*
 CHRISTENSEN, A. M., 944, 949, 950, 954, 966,
 1139, 1150
 CHRISTIANSEN, M. E., 881, *1139*
 CHU, A., 582, *1127*
 CHU, G. W. T. C., 897, *1139*
 CITRO, G., 940, *1205*
 CLARK, A. H., 948-950, *1139*
 CLARK, A. M., 948, *1139*
 CLARK, H. E. S., 949-951, *1139*
 CLARK, H. L., 957-959, *1139*
 CLARK, J. R., 977, *1145*
 CLARK, R. B., 728, *1139*
 CLAUSEN, C., 662, *1139*
 CLEGG, D. J., 802, *1143*
 CLEGG, J. S., 745, *1139*
 CLELAND, K. W., 938, *1139*
 CLEMENS, H. P., 1030, *1212*
 CLEMENTE, L., 956, *1139*
 COATES, C. W., 1067, 1076, 1107, *1139*
 COBB, N. A., 697, *1139*
 COE, W. R., 897, 898, 953, *1140*
 COFFIN, H. G., 874, 879, *1140, 1152, 1169*
 COLE, H. A., 901, *1140*
 COLES, J. S., 1045-1047, *1226*
 COLES, S. L., 664, *1140*
 COLLIER, R. S., 880, 934, *1136, 1140, 1217*
 COLOGER, C. P., 803, 807, *1152*
 COLWIN, L. H., 963, *1140*
 COMBS, B. D., 1022, *1140*
 COMITA, G. W., 763, 764, 788, *1140*
 COMITA, J. J., 763, 764, 788, *1140*
 CONANT, F. S., 648, *1140*
 CONBOY, M. E., 1060, *1140*
 CONES, H. N., JR., 643, 644, *1140*
 CONGER, N., 617, *1148*
 CONKLIN, E. G., 734, *1140*
 CONNELL, J. J., 1083, *1140*
 CONNER, R. L., 602, *1221*
 CONOVER, R. J., 584, 628, 629, 684, 761, 769,
 774, 777, 783, 792, 811, 885, 886, 890, 891,
 893, 897, 899-901, 937, 946, 968, 974, 975,
 981, 986, 1005, *1140, 1178*
 COOK, C. B., 665, 857, *1140*
 COOK, H. L., 837, 847, 858, *1140, 1141, 1181,*
 1203
 COOK, H. W., 1103, *1141*
 COONEY, T. D., 999, 1001, 1003, 1004, *1215*
 COPELAND, M., 728, *1141*
 CORKETT, C. J., 767, 770, 782, 783, 786, 793,
 794, *1141, 1185*
 CORKUM, K. C., 856, *1213*
 CORLISS, J. O., 585, 601, 602, *1141*
 CORNELL, L. H., 1069, *1199*
 CORNER, E. D. S., 747, 774, 786, 792, 807, *1141*
 CORY, R. L., 728, *1141*
 COSTELLO, D. P., 940, 965, *1141*
 COSTELLO, T. J., 857, *1141*
 COSTLOW, J. D., JR., 584, 760, 799, 803, 806,
 854, 874, 881, 883, 889, 894, *1132, 1139,*
 1141, 1142, 1214
 COTTE, J., 628, 630, 639, 640, *1142*
 COULSON, J. C., 1117, 1120, *1142*
 COUPIN, H., 726, *1142*
 COWEY, C. B., 826, 828, 833, 848, 980, 1013-
 1017, *1124, 1142*
 COWLES, R. P., 724, *1142*
 COX, K. W., 851, 852, *1189*
 CRANDALL, L. S., 1036, 1064, 1076, *1142*
 CRANFIELD, H. J., 919, *1143*
 CRAWFORD, B. J., 663, *1138*
 CRAWSHAY, L. R., 770, *1143*
 CREGEEN, T. N., 859, *1212*
 CREUTZBERG, F., 743, 877, *1143*
 CRISP, D. J., 801, 802, 805, 807, 966, *1137,*
 1143, 1152, 1196, 1221
 CROLL, N. A., 706, *1143*
 CROWELL, S., 651, 652, 655, *1143, 1227*
 CROZIER, W. J., 948, *1143*
 CRUICKSHANK, E. M., 1085, *1143*
 CRUMP, L. M., 616, *1144*
 CRYER, E. F., 1075, *1185*
 CSORDAS, S. E., 1095, 1117, 1119, 1120, *1137,*
 1143
 CULLINEY, J. L., 926, 927, *1143*
 CUNNINGHAM, J. T., 859, 977, *1143*
 CUNNINGHAM, P. A., 934, *1143*

- CURTIS, A. S. G., 632, 633, *1143*
 CURTIS, L., 733, 1067, 1088, *1143*
 CŪRY, A., 590, *1168*
 CUSHING, D. H., 781, *1144*
 CASTILLA, J. C., 943, *1137*
 CUTLER, D. W., 616, *1144*
 CUTRESS, C. E., 648, 649, *1224*
 CZIHAK, G., 937, 940, 942, 955, *1144*
- D'AGOSTINO, A. S., 948, *1144*
 DAHLSTÖM, W. A., 879, *1144*
 DAHM, E., 841, *1144*
 DAKIN, W. J., 949, *1144*
 DALES, R. P., 734, 742, *1144, 1223*
 DAN, K., 955, *1144*
 DANIEL, A., 802, 803, *1144*
 DANIELSSEN, D. C., 959, *1176*
 DANNEVIG, A., 859, 977, *1144*
 DARLING, F., 1054, *1144*
 DARLING, H. M., 709, *1149*
 D'ASARO, C. N., 737, *1144*
 DAVID, L. R., 976, *1144*
 DAVIDSON, M. E., 661, 940, 965, *1141, 1144*
 DAVIES, P. A., 802, 805, *1143*
 DAVIS, H. C., 901, 903-906, 908, 910-913, 916,
 918, 924-928, *1136, 1144, 1183*
 DAVIS, L. V., 641, 651, 652, 654, 655, 665, 666,
 975, *1144, 1180, 1218*
 DAWSON, M. A., 880, *1140, 1217*
 DAYKIN, P. N., 970, *1144*
 DAYTON, P. K., 954, *1144*
 DECOPAS, F., 1076, *1144*
 DEFRAN, R. H., 1060, *1197*
 DELAGE, Y., 806, *1144*
 DELAP, M. J., 642, 648, *1145*
 DELAVAUULT, R., 956, *1145*
 D'ELLA, C., 628, *1171*
 DELMENDO, M. N., 856, *1145*
 DELMONTE, P. J., 976-978, *1145*
 DELONG, R. L., 1120, *1145, 1187*
 DEMAR-GERVAIS, C., 621, *1145*
 DEOLALKAI, S. T., 1085, *1145*
 DEPLAECIE, M., 604, 624, *1197*
 DERBÈS, M., 938, *1145*
 DESHIMARU, O., 824, 827-833, 837, 852, *1145*
 DETHLEFSEN, V., 1032, 1033, *1224*
 DEUEL, D. G., 977, *1145*
 DEVANY, T., 857, *1217*
 DEWEY, V. C., 602, *1174*
 DE WINTER, F., 604, 621, 623, 625, *1145*
 DEXTER, D. M., 815, 816, 873, *1145*
 DICKERSON, B. L., 610, 625, *1145*
 DICKIE, L. M., 949, 1010, *1145, 1163*
 DIDZIC, A., 1042, *1125*
 DIETRICH, G., 744, 746, *1145*
 DIETZ-ELBRÄCHTER, G., 600, *1145*
- DISALVO, L. H., 662, *1145*
 DIX, T. G., 954, *1145*
 DIXON, D. R., 725, *1145*
 DJAKONOV, A., 949, 959, *1145, 1146*
 DOBKIN, S., 843, 847, 849, 851, 857, *1146, 1147*
 DODD, J. M., 1023, *1146*
 DÖRJES, J., 674, *1146*
 DOEZEMA, P., 944, *1146*
 DOHL, T. P., 1024, 1027, *1210*
 DONALDSON, E. M., 1024, *1146*
 DONALDSON, H. A., 859, *1146*
 DOREY, A. E., 669, 670, *1146*
 DOUGHERTY, E. C., 685, 686, 691, 700, 735,
 1146, 1161, 1193, 1194
 DOUMENGE, F., 858, *1146*
 DOYLE, J., 591, 622, *1147*
 DRABEK, C. M., 1103, 1104, *1176*
 DRAGER, G. A., 1086, *1203*
 DRAPER, H. H., 1084, *1146*
 DRIES, M., 875, *1146*
 DRINNAN, R. E., 652, *1161*
 DROBECK, K. G., 906, *1184*
 DROOP, M. R., 584, 586, 587, 591-597, 611,
 612, 620, 622, 626, 684, *1147, 1199*
 DUDOK VAN HEEL, W. H., 1042, 1043, 1046-
 1048, 1054, 1062, 1067, 1080, 1107, 1113,
 1115, 1118, *1147*
 DUNATHAN, J. P., 914, *1147*
 DUNBAR, M. J., 1099, *1147*
 DUNHAM, P. B., 607, *1173*
 DUPREE, H. K., 1013, 1018, *1147*
 DUPUY, J. L., 921, *1147*
 DURCHON, M., 734, *1147*
 DURWOOD, M. D., 843, *1147*
 DUTRIEU, J., 753, *1148*
 DYCHE, L. L., 1096, *1148*
 DYE, H. M., 1024, *1146*
 DZWILLO, M., 1029, *1148*
- EATON, C. A., 1114, *1124*
 EBERT, J. D., 938, *1148*
 EBERT, T. A., 952, *1148*
 ECKELBARGER, K. J., 733, 734, *1148*
 ECKERT, R., 622, *1148*
 EDEL, R. K., 1004, 1028, *1148*
 EDMONDSON, C. H., 662, *1148*
 EDMONDSON, W. T., 684, 690, *1148*
 EFREMOVA, S. M., 630, *1148*
 EGAMI, N., 777, *1148*
 EGGERS, A., 940, 965, *1141*
 EGUSA, S., 1007, *1148*
 EHLERS, K., 1092, *1148*
 EHRENBAUM, E., 841, 859, 860, *1148*
 EHRlich, K. F., 987, *1131*
 EIBL-EIBESFELDT, I., 990, *1148*
 EICHEL, H. J., 617, *1148*

- EICHELBAUM, E., 650, 949, 951, 953, *1148*,
1202
- EICHELBERGER, L., 1112, 1113, *1148*
- EKMAN, S., 957, 958, *1148*
- ELBRÄCHTER, M., 587, 622, *1148*
- ELDRED, B., 843, *1169*
- ELLIOT, P. D., 1120, *1187*
- ELLIS, J. N., 1023, *1210*
- ELMHIRST, R., 661, 954, *1148*
- ELSNER, R. W., 1060, *1148*
- ELVEHJEM, C. A., 1086, *1180*
- EMLEN, J. M., 986, *1148*
- EMMERSON, W., 837, *1149*
- ENDEAN, R., 952, *1197*
- ENDERS, H. E., 742, *1149*
- ENDERS, R. K., 1117, *1149*, *1197*
- ENGSTROM, D. G., 580, *1126*
- EPIFANIO, C. E., 689, 822, 839, 876, 936,
1149, *1162*, *1190*, *1215*
- EPPLEY, R. W., 945, *1149*
- ERMAN, L. A., 690, *1149*
- ERWIN, J., 601, *1166*
- ESCRITOR, G. L., 878, *1149*
- ESSAPIAN, F. S., 1121, *1216*
- ETIENNE, N., 1027, *1149*
- EVANS, D. O., 1021, 1022, *1185*
- EVANS, F. R., 616, *1149*, *1201*
- EVANS, R. M., 1003, *1149*
- EWALD, J. J., 847, 857, *1149*
- FABRE-DOMERGUE, A., 971, 976-978, *1149*
- FAGERLUND, U. H. M., 944, *1149*
- FAHEY, W. E., 977, *1149*
- FAIR, G. M., 1077, *1149*
- FARMANFARMAIAN, A., 946, 948, 950, 953,
955, *1144*, *1149*, *1156*, *1158*
- FAULKNER, D. J., 881, *1157*, *1200*
- FAULKNER, G. H., 742, *1149*
- FAULKNER, L. R., 709, *1149*
- FAVA, G., 765, 789, *1129*, *1221*
- FAXON, W. A., 849, *1149*
- FAY, F. F., 1117, *1149*
- FAY, F. H., 1073, 1074, *1201*
- FEDER, H. M., 944, 949, 950, 952, 954, 966,
975-977, 987, *1150*, *1179*
- FEDER, W. A., 692-694, 704, 709-711, *1188*
- FEENY, P. P., 616, *1225*
- FELBER, F., 651, 656, 657, *1126*
- FELL, H. B., 944, 947, 949, 956, 959, *1150*
- FELL, J. W., 704, 710-712, *1167*
- FELTS, W. J. L., 1048, *1150*
- FENCHEL, T., 603, 604, 613, 614, 624, 950,
1150, *1179*
- FERGUSON, J. C., 937, 944-946, 948, 952, 953,
1150
- FERLIN, V., 945, *1136*
- FERRAL, D. J., 685, 735, *1146*
- FETCHER, E. S., 1112, 1113, *1148*
- FIELD, G. A., 926, *1150*
- FIELDER, D. R., 843, 879, *1150*
- FIELDING, J. R., 858, *1171*
- FIGUEIREDO, M. J. DE, 870, *1150*
- FIGUEROA, F., 617, *1148*
- FINCO, G., 765, 789, *1129*
- FISCHER, A., 723, 724, 732, *1150*, *1163*
- FISCHER, E. C., 610, 625, *1145*
- FISCUS, C. H., 1093-1097, *1150*, *1171*
- FISH, J. D., 948, *1150*
- FISHELSON, L., 977, 978, *1151*
- FISHER, H. D., 1075, 1076, 1097-1099, 1119,
1121, *1144*, *1151*, *1162*
- FISHER, K. C., 1076, *1169*
- FISHER, W. K., 950, 951, 958-960, *1151*
- FITZGERALD, G. P., 1081, *1151*
- FITZGERALD, W. J., 1007, *1218*
- FLEMER, D. A., 776, *1164*
- FLEMING, R. H., 589, *1184*
- FLÜCHTER, J., 621, 975, 981, 993, 1022, *1151*
- FØYN, B., 651, 656, 732, *1151*
- FOGG, G. E., 616, *1151*
- FOL, H., 938, *1151*
- FONDS, M., 994, *1205*
- FONTAINE, A. R., 954, *1151*
- FONTAINE, M., 616, 1023, 1027, 1028, *1151*,
1152, *1218*
- FORBES, L., 801, *1152*
- FORD, R. F., 758, 851, 861, 863, 864, *1209*
- FORD, T. B., 857, *1152*
- FORDHAM, M. G. C., 733, *1152*
- FORET, J.-P., 736, *1130*
- FORET-MONTARDO, P., 736, *1130*
- FORRESTER, C. R., 976, *1152*
- FORSS, C. A., 858, 879, *1152*, *1197*
- FORSTER, J. R. M., 826, 828, 833, 836, 848,
1142, *1152*
- FOSTER, P., 807, *1221*
- FOULK, H. R., 747, *1229*
- FOWLER, S. W., 934, *1152*
- FOX, H. M., 955, 961, *1152*
- FOX, M. H., 940, 965, *1141*
- FOXTON, P., 858, *1152*
- FRANK, J. R., 877, *1152*
- FRANKENBERG, D., 728, *1152*
- FRANKLAND, A., 1112, *1152*
- FRASER, J. H., 763, *1152*
- FRASER, L. C., 763, 788, *1152*
- FREEMAN, H. C., 1029, 1030, *1218*
- FREIBERGER, A., 803, 807, *1152*
- FRETTER, V., 887, 889, 891-894, *1152*, *1198*
- FREUDENTHAL, H. D., 596, 597, 605, 702,
1152, *1180*
- FRICKE, H. W., 945, *1152*

- FRIEDL, H., 713, 715, *1152*
 FRIEDMAN, L., 1006, 1008, *1152*
 FROSCH, P., 591, *1153*
 FRY, W. G., 627, 634, 635, *1153*
 FÜLLER, H., 728, *1153*
 FUJI, A., 952-955, *1153*
 FUJII, M., 1017, *1228*
 FUJIMOTO, A., 1093, *1192*
 FUJIMURA, T., 845, 846, *1153*
 FUJINAGA, M., 835, 852, *1153*
 FUJITA, A., 1085, *1153*
 FUJITA, S., 977, 978, 1007, *1153*
 FUJIYA, M., 901, 929-932, 934, *1153*
 FUKASE, H., 965, *1170*
 FUKUDA, Y., 1022, *1210*
 FULLER, J. L., 770, 791, *1153*
 FULTON, C., 651, 652, 656, 657, 744, *1153*
 FURUICHI, M., 1005, 1012, 1017, *1228*
 FURUKAWA, I., 679, 689, 853, *1153*
 FUSELER, J. W., 960, 964, *1153*
- GABBOTT, P. A., 583, 746, 833, 915, *1153*,
1171, 1172
 GALE, E. F., 1003, *1153*
 GALLUCCI, V. F., 900, *1168*
 GALTSOFF, P. S., 584, 585, 631, 633, 859, 860,
 901, 925, 926, 945, 949, 962, *1154*
 GARBER, B. I., 785, *1154*
 GAROFA, T., 1023, *1188*
 GARROD, L. P., 1003, *1154*
 GARSIDE, E. T., 970, 971, *1154*
 GARSTANG, W., 975, *1154*
 GASKIN, D. E., 1108, 1113, *1154, 1212*
 GAUDENZI, B., 690, *1154*
 GAUDY, R., 767, 768, 790, 792, 794, 796, 798,
1154
 GAULD, D. T., 791, 794, 809, *1154*
 GAUSE, G. F., 616, *1154*
 GAYLORD, H. R., 1016, *1154*
 GEILING, E. M. K., 1112, 1113, *1148*
 GEMMILL, J. F., 661, 951, 952, 960, 961, *1154*,
1155
 GEORGE, J. D., 723, 736, 766, *1155*
 GEORGE, M. J., 847, *1155*
 GERACI, J. R., 1076, 1082-1086, 1093, 1100,
 1102, 1106, *1155*
 GERARD, R. D., 582, *1155, 1204*
 GERASIMOV, V. V., 990, 991, *1155*
 GERLACH, S. A., 692, 700, 701, 703, 704,
 706-708, 710-712, *1155*
 GERSTMANN, K. E., 1083, *1155*
 GEWALT, W., 1038, 1041, 1044, 1047, 1062,
 1065, 1067, 1072, 1087-1089, *1155, 1156*
 GIBBNEY, L. F., 1117, *1156*
 GIBSON, G. G., 930, *1156*
 GIBSON, V. R., 786, *1158*
- GIESA, S., 671, 672, *1156*
 GIESE, A. C., 944, 945, 950, 952, 953, 955,
1149, 1156, 1158, 1179, 1197
 GIHR, M., 1092, 1110, *1156, 1198*
 GILAT, E., 763, 788, *1156*
 GILBERT, J. J., 684, 685, 687, 690, 691, *1131*,
1156
 GILCHRIST, B. M., 745, *1156*
 GILLET, D., 765, *1156*
 GILMARTIN, W. G., 1120, *1145, 1187*
 GILPIN-BROWN, J. B., 726, *1156*
 GIRARD, S. M., 999, 1001, 1003, 1004, *1215*
 GIESA, I. I., 991, *1156*
 GIERVIN, D., 1120, *1187*
 GISLÉN, T., 950, *1156*
 GJØEN, I., 732, *1151*
 GLYNN, P. W., 952, *1156*
 GNEWUCH, W. T., 919, *1185*
 GNITETSKY, N. A., 1075, *1127*
 GOERKE, H., 726-729, *1156*
 GOLD, K., 585, 586, 588-591, 603, 605, 611,
 612, 620, 622, 624-627, *1157, 1185, 1199*
 GOLDSBERRY, D. G., 1053, 1054, 1088, 1111,
 1113, *1158*
 GOLOVINSKAYA, K. A., 1031, *1157*
 GOMEZ, E. D., 881, *1157*
 GONOR, J. J., 956, *1157*
 GONZALEZ, J. G., 769, 786, 790, *1229*
 GOOCH, J. L., 1029, *1157*
 GOPALAKRISHNAN, K., 812, *1157*
 GOPALAKRISHNAN, V., 638, *1171*
 GORDIN, H., 1007, *1198*
 GOREAU, T. F., 949, *1157*
 GOSLINE, J. M., 665, *1157*
 GOSSELCK, F., 656, *1157*
 GOTTHOLD, M. L., 735, *1146*
 GOTTLIEB, D., 1003, *1157*
 GOUDSMIT, E. M., 948, *1206*
 GOULD, H. N., 898, *1157*
 GRABERT, B., 600, *1184*
 GRAEFFE, E., 638, *1157*
 GRAF, V., 898, 900, *1187*
 GRANGUARD, R., 1085, *1157*
 GRAS, P., 917, *1157*
 GRAUPNER, H., 713, 714, 716, *1157*
 GRAVE, B. H., 716, 724, 727, *1157*
 GRAW, C. R., 1083, *1210*
 GRAY, I. E., 949, 951, *1223*
 GRAY, J. S., 620, 734, 735, *1158*
 GRAY, W. B., 1067, 1069, 1087, 1089, *1158*
 GRAYBILL, J. R., 1030, *1158*
 GREENFIELD, L., 953, 955, *1156, 1158*
 GREENGART, A., 698, 702, 703, 709, 712, *1217*
 GREENWOOD, A. G., 1047, 1060, *1158*
 GRILL, K. G., 596, 597, *1158*
 GREVE, W., 975, *1158*

- GRICE, G. D., 777, 786, *1158*
 GRIEG, J. A., 950, 951, *1158*
 GRIFFIN, E. I., 1046, 1053, 1054, 1088, 1111, 1113, *1158*
 GRIFFITH, G. W., 857, 884, *1158*, *1229*
 GRIMMER, W., 1112, *1159*
 GRINNELL, S. W., 1073, 1074, *1208*
 GROOM, T. T., 799, *1159*
 GROPP, J., 1006, *1217*
 GROSS, A. O., 728, *1159*
 GROSS, F., 590, 622, 747, 770, 779, 786, 976, 977, *1159*, *1201*
 GROSSMAN, R., 596, 597, *1180*
 GRUBE, A. E., 959, 960, *1159*
 GRUFFYDD, LL. D., 634, 859, 901, 903, 925, 926, *1159*
 GUBERLET, J. E., 726, 951, *1159*, *1204*
 GÜNTHER, R. T., 929, *1159*
 GÜNZL, H., 651, 658, *1159*
 GUÉRIN, J.-P., 724, 765, *1156*, *1159*
 GUILLARD, R. R., 908, 910, *1144*
 GUILLARD, R. R. L., 612, 626, *1159*
 GULLAND, J. A., 971, *1159*
 GUNTER, G., 820, 824, 825, 827, 833, 838, 857, *1220*
 GURNEY, R., 849, 858, *1159*
 GUSTAFSON, T., 938, 940, *1159*
 GUTTMAN, H. N., 690, *1178*

 HABERKORN, E.-D., 1067, *1156*
 HACKETT, P. L., 602, *1221*
 HADLEY, P. B., 859, *1159*
 HAGENBECK, C.-H., 1107, *1159*
 HAGMEIER, A., 584, 641, 642, 647, 650, 654, 661, 725, 859, 860, 862, 901, *1160*
 HAIN, J. H. W., 1004, *1160*
 HAINES, K. C., 582, *1127*, *1204*
 HALBACH, U., 685, 689, 690, 691, *1160*
 HALBACH-KEUP, G., 685, 689, 690, *1160*
 HALE, J., 758, *1130*
 HALE, L. J., 651, 652, *1160*
 HALEVY, A., 1032, *1200*
 HALL, D. N. F., 847, *1160*
 HALL, H. C., 1017, *1209*
 HALL, R. P., 585, *1160*
 HALSBAND, E., 1033, *1160*
 HALVER, J. E., 968, 1005, 1009, 1012, 1013, 1015-1019, *1160*, *1182*, *1229*
 HAMADA, S., 949, *1169*
 HAMANN, O., 949, *1160*
 HAMBLY, A., 1112, *1152*
 HAMDORF, K., 970, *1160*
 HAMILTON, J. E., 1096, 1097, 1117, *1160*
 HAMILTON, R. D., 612, 626, *1160*
 HAMM, G. L., 582, *1127*
 HAMMETT, F. S., 652, 659, *1160*, *1161*

 HAMOND, R., 734, *1161*
 HAMPSON, G. E., 948, *1207*
 HANAOKA, H., 747, 764, 789, *1161*
 HANCOCK, D. A., 652, 945, 949, 950, *1161*
 HAND, C., 652, *1161*
 HANNA, B. A., 613, 614, 626, *1161*
 HANSEN, D. J., 758, 759, *1207*
 HANSEN, E. L., 691, *1193*
 HAQ, S. M., 777, 779-782, 793, *1161*
 HARDER, W., 977, 978, *1136*
 HARDING, G. C. H., 795, *1161*
 HARDY, A. C., 981, *1161*
 HARGITT, G. T., 648, *1161*
 HARGITT, W., 648, *1161*
 HARLEY, M. B., 725-728, *1161*
 HARRIS, L. G., 685, 686, *1146*, *1161*
 HARRIS, W. N., 652, *1161*
 HARRISON, R. J., 1044, 1047, 1054, 1060, 1073-1075, 1093, 1115, 1117-1119, 1121, 1125, 1151, *1158*, *1161*, *1162*
 HART, J. F. L., 874, *1162*
 HART, J. S., 1074-1076, *1144*, *1162*, *1169*
 HARTLAUB, C., 650, 651, 653, 654, *1162*
 HARTMAN, H. B., 962, *1162*
 HARTMAN, M., 936, *1162*
 HARTMANN, M., 731, *1162*
 HARVEY, E. B., 938, 939, 945, 953, 963, 964, *1162*
 HARVEY, H. W., 791, 955, *1162*
 HASHIMOTO, D. Y., 999, 1001, 1003, 1004, *1215*
 HASHIMOTO, Y., 1015-1018, *1162*
 HASKINS, C. P., 669, *1168*
 HASPER, M., 713, 715, *1162*
 HASTINGS, W. H., 836, 1010, *1162*, *1188*
 HATANAKA, M., 901, 949, *1163*, *1169*
 HAUENSCHILD, C., 584, 651, 653, 658, 713, 722, 723, 731, 734, 760, *1163*
 HAVEN, D. S., 919, *1137*
 HAVENS, W. K., JR., 914, *1147*
 HAVINGA, B., 1119, *1163*
 HAWES, R. S. J., 585, 592, *1185*
 HAZLETT, B. A., 581, *1163*
 HEAD, R. N., 774, *1141*
 HEBB, D. O., 1121, *1184*
 HEBLING, N. J., 654, *1193*
 HEDLEY, R. H., 597, *1163*
 HEEGAARD, P., 858, *1163*
 HEINEN, A., 727, *1163*
 HEINLE, D. R., 768, 769, 775-777, 790, 793, *1164*
 HELM, M. M., 916, 923, *1164*
 HEMLAY, D. W., 949, 950, *1168*
 HEMMINGS, C. C., 990, *1164*
 HEMPEL, C., 740, *1164*
 HEMPEL, G., 977, 978, 981-983, 987, 992, 995-997, *1131*, *1132*, *1136*, *1164*, *1205*

- HEMPELMANN, F., 728, 1164
 HENDERSON, E. B., 1017, 1209
 HENLEY, C., 940, 965, 1141
 HENRIQUEZ, G., 879, 1127
 HENTIG, R. VON, 745, 747, 751, 1164
 HENTSCHEL, E., 638, 713, 715, 1164
 HENTSCHEL, H., 981, 1164
 HERBST, B. A., 617, 1181
 HERBST, C., 940, 1164
 HERDMAN, W. A., 859, 951, 1164
 HERLANT, M., 1027, 1195
 HERRIN, R., 726, 728, 1164
 HERRICK, F. H., 841, 860, 861, 1134, 1164
 HERRING, P. J., 858, 880, 954, 1164
 HERRMANN, K., 659, 921, 1164
 HERTEL, E. W., 690, 1164
 HERTLING, H., 968, 971, 976, 1164
 HERTWIG, O., 938, 1164, 1165
 HERTWIG, R., 938, 1165
 HERZ, L. E., 803, 1165
 HESS, W. N., 738, 1165
 HESSINGER, D., 666, 1205
 HESSLER, R. R., 954, 1144
 HEUTS, M. J., 978, 1165
 HEWATT, W. G., 950, 1165
 HEWER, H. R., 1117, 1119, 1120, 1165
 HEWLETT, K. G., 1088, 1111, 1165
 HEYDORN, A. E. F., 1068, 1165
 HIATT, R. W., 854, 1006, 1165
 HICKLING, C. F., 1031, 1032, 1117, 1120, 1165
 HICKLING, G., 1117, 1120, 1142
 HIDAKA, K., 679, 689, 1153
 HIDU, H., 906, 913, 919, 920, 922, 1165, 1184, 1203, 1220
 HIGUCHI, J., 977, 1189
 HILDEBRANDT, A. C., 696, 1172
 HILL, B. J., 879, 1165
 HINCHCLIFFE, P. H., 760, 1165
 HINDLEY, J. P. R., 858, 1165
 HINEGARDNER, R. T., 938-944, 964, 965, 1136, 1165
 HIRANO, R., 806, 975-977, 1165, 1173
 HIRATA, H., 679, 818, 820, 837, 853, 1166, 1190
 HIRAYAMA, K., 679, 682, 683, 689, 1166
 HIROI, O., 1028, 1228
 HIROSE, K., 1028, 1166
 HIROTA, J., 582, 1215
 HJORT, J., 971, 972, 1166
 HOAR, W. S., 977, 978, 1185
 HOCK, R., 1075, 1208
 HODGINS, H. O., 1030, 1166
 HOEL, P. G., 1117, 1119, 1129
 HÖRSTADIUS, S., 937, 938, 940, 1166
 HOEY, A., 1065, 1166
 HOFMANN, D. K., 651, 658, 723, 724, 731, 732, 1131, 1163, 1166
 HOGG, J. J., 631, 635, 1130
 HOLDEN, A. V., 1036, 1166
 HOLLAND, D. L., 804, 923, 1164, 1166
 HOLLAND, N. D., 955, 1166
 HOLLIDAY, F. G. T., 986, 1022, 1132
 HOLLING, C. S., 984, 985, 995, 1166
 HOLMAN, J. A., 757, 1212
 HOLTHUIS, L. B., 842, 843, 1166
 HOLTMANN, A., 862, 866, 1053, 1061, 1086, 1087, 1118, 1120
 HOLZ, G. G., JR., 601, 602, 607, 1166, 1173
 HOMESTEAD, R., 1043, 1166
 HONGPROMYART, M., 879, 1219
 HOOD, M. A., 882, 1166
 HOPE, W. D., 692, 1167
 HOPLEY, S., 954, 1126
 HOPPENHEIT, M., 765, 1167
 HOPPER, B. E., 697, 698, 704, 706, 707, 709-712, 1167, 1188
 HORI, J., 901, 1167
 HORNELL, J., 727, 1167
 HOROWITZ, L., 602-604, 606, 621, 623-625, 1172
 HORTON, H. F., 1029, 1030, 1158, 1167, 1196
 HORWITT, M. K., 1086, 1227
 HOUDE, E. D., 978, 982, 987, 988, 1167, 1206
 HOURSTON, A. S., 1029, 1167
 HOWELL, B. R., 879, 980, 1167, 1211
 HOYLE, R. J., 1029, 1030, 1167, 1218
 HUANG, H., 953, 1156
 HUANG, T. L., 1023, 1027, 1181
 HUBBARD, R. C., 1052-1054, 1064, 1073, 1075, 1076, 1087, 1093, 1102, 1104, 1106, 1120, 1121, 1161, 1167, 1185, 1199, 1220
 HUBLON, W. F., 1005, 1006, 1179, 1211
 HUBSCHMAN, J. H., 849-851, 1134, 1167
 HUDINAGA, M., 803, 818, 837, 847, 852-854, 1167
 HUDSON, R. C. L., 652, 1167
 HUET, M., 1010, 1168
 HUEZ, G., 955, 1228
 HUGHES, E., 901, 1168
 HUGHES, J. T., 861, 863-865, 870, 1168
 HUGHES, R. H., 900, 1168
 HULATA, G., 1032, 1200
 HULINGS, N. C., 949, 950, 1168
 HULL, R. W., 615, 1168
 HUMPHREYS, T., 631, 1168
 HUNT, O. D., 743, 949, 950, 1168
 HUNTER, J. R., 973, 980, 982-984, 990, 992-997, 1034, 1168
 HUTH, W., 731, 1162, 1168
 HUTNER, S. H., 585, 589, 590, 620, 622, 669, 1168, 1174
 HUXLEY, J. S., 631, 642, 659, 1129, 1168
 HWANG, P. C., 1029, 1030, 1191

- HYLLEBERG, J., 900, *1168*
 HYMAN, L. H., 679, 709, 884, 937, 938, 943,
 944, 952, 955, 956, *1168, 1169*

 IBRAHIM, K. H., 1023, *1169*
 ICHIHARA, T., 1119, *1169*
 IDLER, D. R., 1029, 1030, *1167, 1191, 1218*
 IDYLL, C. P., 857, *1169*
 IIDA, T., 965, *1169*
 IKEDA, H., 956, *1195*
 IKEDA, T., 766, 798, *1169*
 IKEGAMI, S., 962, *1169*
 IMAI, T., 898, 901, 916, 926, *1169*
 IMLER, R. H., 1099, *1169*
 IMMERS, J., 940, *1205*
 INASE, M., 735, 739, *1169*
 INGHAM, S. E., 1117, 1119, 1120, *1136*
 INGLE, R. M., 843, 914, *1147, 1169*
 INO, T., 898, 899, 949, *1169*
 INOUE, H., 854, *1216*
 INOUE, M., 765, 898, 899, *1169*
 INOUE, Y., 952, 953, *1218*
 IRELAND, C., 881, *1157, 1200*
 IRVINE, A. B., 1047, 1060, *1169*
 IRVINE, J., 874, 879, *1169*
 IRVING, L., 1073-1076, *1162, 1169, 1208*
 ISHIDA, J., 941, *1169*
 ISHIDA, R., 1028, *1166*
 ISHIDA, S., 806, *1169*
 ISHIKAWA, M., 938, 940, *1169*
 ISHIKAWA, N., 952, *1195*
 ISHIKAWA, S., 824, 827, 828, 832, *1175, 1211*
 ITO, T., 684, 690, 788, *1169*
 IVANCHENKO, L. A., 978, *1169*
 IVANCHENKO, O. F., 978, *1169*
 IVKER, F. B., 658, *1170*
 IVLEV, V. S., 986, *1170*
 IVLEVA, I. V., 753, *1170*
 IWANAGA, N., 1018, *1195*
 IWASAKI, H., 786, *1170*
 IWASAKI, T., 755, *1192*
 IWATA, K. S., 926, 927, 963, 965, *1170*

 JACOBI, E. F., 745, *1170*
 JACOBS, J., 786, *1170*
 JACOBS, S. A., 1120, *1187*
 JÄGERSTEN, G., 735, *1170*
 JARVIS, C., 1054, *1170*
 JATZKE, P., 867-870
 JEBRAM, D., 713, 715, 718, 719, *1170, 1171*
 JENKINS, W. R., 691, *1206*
 JENNINGS, H. S., 949, *1171*
 JENNINGS, J. B., 671, *1171*
 JENNINGS, R., 1087, 1104, 1106, *1199*
 JENNINGS, R. H., 745, *1171*
 JERDE, G. W., 809-811, *1171*

 JHINGRAN, V. G., 638, 1023, *1171*
 JOB, T. J., 856, *1174*
 JØRGENSEN, C. B., 629, *1171*
 JOHANNES, R. E., 620, 628, *1171*
 JOHANSEN, A. C., 970, *1171*
 JOHN, D. D., 957, 958, 960, *1171*
 JOHNSON, B. W., 1064, *1171*
 JOHNSON, M. C., 858, *1171*
 JOHNSON, M. L., 1097, *1171*
 JOHNSON, M. W., 734, 765, 789, *1171*
 JOHNSON, R. N., 703, *1221*
 JOHNSON, W. H., 585, *1171*
 JONCH, A., 1067, 1089, *1171*
 JONES, A. J., 745, 748, 751, 752, *1171*
 JONES, D. A., 583, 746, 833, 915, *1153, 1171,*
1172
 JONES, J. A., 954, *1190*
 JONES, L. M., 1086, *1172*
 JONES, L. W., 696, *1172*
 JONES, M. L., 652, 1054, 1055, 1058, *1161,*
1172
 JONES, W. C., 633, 635, 636, *1172*
 JORDAN, M. R., 966, *1133*
 JOSEPHSON, R. K., 661, *1172*
 JUST, E. E., 727, *1172*
 JUTARE, T., 954, *1190*

 KABATA, Z., 975, *1172*
 KÄHLER, H. H., 735, *1172*
 KÄNDLER, R., 725, 901, *1160, 1172*
 KAGAN, I. G., 896, *1172*
 KAHAN, D., 602-604, 606, 621, 623-625, 701,
 708, 712, 789, *1130, 1172*
 KAIM-MALKA, R. A., 736, *1130*
 KAISLING, K.-E., 713, 716, *1172*
 KAJIMURA, H., 1094, *1150*
 KAKINO, J., 1018, *1195*
 KAKINUMA, Y., 651, *1172*
 KALK, M., 949, *1185*
 KALLE, K., 744, 746, *1145*
 KALLMAN, K. D., 1031, *1172*
 KAMIGAKI, M., 785, *1173*
 KANATANI, H., 962, *1172, 1194*
 KANAZAWA, A., 746, 820, 835, *1172, 1210*
 KANEKO, K., 953, *1192*
 KANELLIS, A., 651, 658, *1163*
 KANESHIRO, E. S., 607, *1173*
 KANGAS, P., 1104, *1196*
 KANNER, M., 745, *1127*
 KAN-NO, H., 888, 889, 898, 899, *1173*
 KANWISHER, J., 691, 1075, *1173, 1225, 1226*
 KANWISHER, J. W., 628, *1173*
 KARANDE, A. A., 801, 804, 806, *1173*
 KARBE, L., 651, 665, *1173*
 KARLSON, P., 616, *1173*
 KARST, H., 990, *1177*

- KARSTENS, W. K. H., 745, *1127*
 KASAHARA, H., 803, *1167*
 KASAHARA, S., 785, 786, 975-977, *1173*
 KASHIWADA, K., 835, *1172*
 KASHIWADA, K.-I., 746, *1210*
 KATHIRVEL, M., 847, *1220*
 KATO, H., 755, *1192*
 KATONA, S. K., 775-777, 781, 782, 793, 794, *1173*
 KAUFMAN, G. W., 1118, *1173*
 KAUSCH, H., 1021, *1173*
 KAWAGUTI, S., 662, *1173*
 KAWAMURA, K., 945, *1173*
 KAWANO, T., 820, *1195*
 KAWASAKI, M., 835, *1172*
 KAWATSU, H., 1017, *1126*
 KAY, D. G., 728, *1173, 1174*
 KAZAROVITSKII, L. M., 991, *1132*
 KELLER, D. E., 589, 590, *1174*
 KELLER, S. E., 589, 590, 622, *1174*
 KELLY, A. L., 1103, *1198*
 KENK, R., 668, *1174*
 KENSLER, C. B., 859, *1174*
 KENYON, K. W., 1095, 1099, 1117, 1120, *1174, 1226*
 KERNEIS, A., 727, *1174*
 KESSLER, M., 725, *1174*
 KESTEVEN, G. L., 856, *1174*
 KEYES, M. C., 1077, 1084, 1093-1095, 1102, 1103, 1105-1107, *1126, 1174*
 KHLEBOVITCH, V. V., 728, *1174*
 KIDDER, G. W., 585, 602, 616, *1174*
 KIECHLE, H., 690, 691, *1135*
 KIKUCHI, S., 888, 889, 897-900, *1173, 1174*
 KILIAN, E. F., 629, *1174*
 KILVINGTON, C. C., 774, *1141*
 KIM, J. D., 888, 892, 895, *1174*
 KING, C. E., 691, *1174*
 KING, J., 1093, 1097, 1098, 1119, *1174*
 KINGSTON, P., 906, *1174*
 KINNE, E. M., 970, *1175*
 KINNE, O., 579, 581, 584, 643, 651, 655-657, 665, 677, 683, 709, 713, 748, 749, 751, 752, 808, 838, 845, 847, 870, 877, 878, 901, 917, 937, 952, 953, 955, 963, 968, 970, 972, 1021, 1033, 1036, 1051, 1053, 1054, 1060, 1062, 1077, 1081, 1093, 1106, 1121, 1122, *1174, 1175*
 KINNEAR, J. E., 976, 978, *1176*
 KINOSHITA, S., 747, *1216*
 KINOSHITA, T., 926, *1175*
 KINUMAKE, T., 1085, *1215*
 KINZIE, R. A., 628, *1171*
 KIRBY, H., 585, 592, *1175*
 KIRK, R. G., 1032, *1175*
 KISCH, B. S., 949, *1175*
 KISSIL, G. W., 1007, *1130, 1198*
 KITABAYASHI, K., 823, 827, 828, 832, *1175, 1211*
 KITAJIMA, C., 786, 787, *1175*
 KITAMORI, R., 736, *1175*
 KITAMURA, S., 1018, *1126*
 KITATAKA, J., 819, 853, 854, *1167, 1175*
 KJERSKOG-AGERSBORG, H. P., 951, *1176*
 KLEPAL, W., 804, *1176*
 KLIMA, E. F., 976, 978, *1176*
 KLÖCKNER, K., 732, 736, *1176*
 KLÖS, H.-G., 1067, *1176*
 KLOSEK, R. Č., 602, *1181*
 KLUDT, T. A., 601, *1201*
 KLYUCHAREV, K. V., 785, *1176*
 KNIGHT, A. P., 859, *1176*
 KNIGHT-JONES, E. W., 800, 801, *1191*
 KNIPOWITSCH, N., 886, *1176*
 KNOWLTON, R. E., 841, 849, *1176*
 KNOX, D., 1017, *1142*
 KOBAYASHI, S., 926, *1176*
 KOEHLER, R., 959, *1176*
 KOGA, F., 762, 788, *1176*
 KOMAKI, Y., 809-811, *1176*
 KOO, J. H., 888, 892, 895, *1174*
 KOOPS, H., 1006, *1217*
 KOOYMAN, G. L., 1060, 1073-1075, 1093, 1103, 1104, 1117-1119, *1161, 1176*
 KOPAC, M. J., 941, *1176*
 KOREN, J., 959, *1176*
 KORRINGA, P., 901, *1176*
 KORSCHULT, E., 734, *1176*
 KOSAKA, M., 949, *1163*
 KOSSOY, V., 596, 597, *1180*
 KOTTHAUS, A., 977, *1176*
 KOZLOFF, E. N., 672, 673, *1177*
 KOZLOV, L. F., 1075, *1127*
 KRAMER, D., 976, *1177*
 KRAMER, R. H., 757, *1212*
 KRAUS, C., 1092, *1156*
 KREMER, B. P., 671, *1177*
 KRETCHMER, N., 1104, *1177*
 KRISHNAN, S., 946, *1177*
 KRISZAT, G., 940, *1205*
 KRÍŽENEČKY, J., 735, *1177*
 KROGH, A., 970, 1104, *1171, 1177*
 KROLL, W. R., 1039, *1177*
 KRÜGER, F., 721, 722, *1177*
 KUBO, K., 958, 960, *1177*
 KUBOTA, H., 955, *1144*
 KÜHLMANN, H. H., 990, *1177*
 KÜHNHOLD, W. W., 1033, *1177*
 KUENEN, D. J., 759, *1177*
 KÜSTER, E., 588, *1177*
 KUHLMANN, H., 1004, *1177*
 KUNITSYN, YU., 969, *1177*

- KUNJU, M. M., 879, *1177*
 KUNZE, S., 620, *1131*
 KUO, C.-M., 1022-1024, *1177, 1193, 1210*
 KUPELWIESER, H., 713, 715, *1178*
 KURATA, H., 827, 828, 976-978, *1175, 1178, 1271*
 KURIYAN, G., 1006, *1138*
 KUROKI, K., 832, *1145*
 KUSAKABE, D., 901, *1167*
 KUSANO, T., 679, 682, 683, 689, *1166*
 KUWATANI, Y., 906, *1178*
 KWASIKPUI, D. B., 685, *1178*
- LAALE, H. W., 989, *1178*
 LADERMAN, A. D., 686, 690, *1178, 1193*
 LAKSHMI, G. J., 820, 824, 825, 827, 833, 837, 838, 857, *1220*
 LALLI, C. M., 885, 886, 890, 891, 893, 897, 899, 900, *1140, 1178*
 LALLIER, R., 940, 965, *1178*
 LAM, T. J., 1007, *1212*
 LAMBERT, R. J., 654, *1178*
 LAMPERT, K., 957, *1178*
 LANCE, J. R., 763, 788, *1199*
 LANDE, R., 1005, *1178*
 LANDENBERGER, D. E., 951, *1178*
 LANDERS, W., 919
 LANDERS, W. S., 912-914, *1203*
 LANDRY, M. R., 986, *1178*
 LANGTON, R. W., 924, *1227*
 LARSON, G., 748, *1178*
 LASKER, R., 682, 809-812, 945, 952, 953, 975-977, 979, 987, 1022, 1023, *1149, 1156, 1171, 1178, 1179, 1181, 1197, 1217*
 LAUBENFELS, M. W. DE, 639, *1179*
 LAUCKNER, G., 585, 667, 973, 1036, 1062, 1070, 1084, *1179*
 LAUER, B. H., 1112, *1179*
 LAURENCE, G. C., 984, 988, *1179*
 LAW, D. K., 1005, 1006, *1179, 1211*
 LAWRENCE, J. M., 944, 945, *1179, 1199*
 LAWS, R. M., 1074, 1098, 1117, 1119, 1120, *1179*
 LAZZARETTO-COLOMBERA, I., 765, 789, *1179*
 LEATHERWOOD, J. S., 1105, *1211*
 LEBOUR, M. V., 791, 858, 874, 889, 900, 975, *1159, 1179*
 LEDEBUR-VILLIGER, M. VON, 940, *1179*
 LEE, C. C., 603, 604, 624, *1179*
 LEE, D. J., 1016, *1179*
 LEE, H., 1045, 1053, *1179*
 LEE, J. J., 596-600, 605, 613, 626, 691, 692, 695, 696, 698-700, 702, 703, 706, 708-712, *1179, 1180, 1191, 1198, 1217*
 LEHMANN, F. E., 733, *1180*
 LEICK, V., 601, *1180*
- LEIGHTON, D. L., 888, 889, 892, 898, 899, 952, *1180*
 LEIVESTAD, H., 1075, *1173*
 LENDENFELD, R. VON, 630, *1180*
 LENHOFF, H. M., 641, 655, 666, 744, 745, 748, 755, *1180, 1183, 1205*
 LEONG, R., 1022, *1180*
 LEOSCHKE, W. L., 1086, *1180*
 LERAY, C., 1013, *1219*
 LESHCHEVA, T. S., 991, *1180*
 LESH-LAURIE, G. E., 656, *1181*
 LESLIE, G., 1087, *1181*
 LEUNG TACK, K., 736, *1130*
 LEWINSKY, G. VON, 731, *1162*
 LEWIS, A. G., 775, 792, *1181*
 LEWIS, C. A., 806, *1181*
 LEWIS, D. B., 728, *1181*
 LEWIS, F., 1094, *1181*
 LEWIS, J. B., 843, *1181*
 LIAO, I. C., 1023, 1025, 1027, *1181*
 LIEBERKIND, I., 958, *1181*
 LIEBERKÜHN, N., 630, *1181*
 LIGUORI, V. R., 585, 586, 622, *1157*
 LILLELUND, K., 975, 979, *1181*
 LILLIE, F. R., 938, 940, 941, *1181*
 LILLY, D. L., 610, 625, *1193*
 LILLY, D. M., 602, 610, 613-618, 625, 626, *1145, 1161, 1181, 1202, 1214*
 LILLY, J. C., 1045, 1062, *1181*
 LIN, M. C., 1023, 1027, *1181*
 LIN, S. Y., 1010, *1181*
 LIN, Y. C., 1073, 1075, *1225*
 LINCOLN, R. F., 1031, *1200*
 LINDBERG, R. G., 872, *1181*
 LINDNER, M. J., 857, 858, *1141, 1181, 1225*
 LINDROTH, A., 728, *1182*
 LINDSEY, A. A., 1117, *1182*
 LINDSTEDT, K. J., 665, *1182*
 LINFORD, M. B., 692, *1182*
 LING, J. K., 1060, 1061, 1073, *1182*
 LING, S. W., 817, 818, 844-846, *1182*
 LISTON, J., 1083, *1182*
 LITTLE, E. E., 581, *1182*
 LITTLE, G., 848, *1182*
 LITTLEFORD, R. A., 648, *1182*
 LIVINGSTON, D. L., 1022, *1199*
 LOCK, A. R., 783, 794, *1182*
 LOEBLICH, A. R., III., 590, *1218*
 LOGAN, C. M., 936, *1149*
 LOISEL, G., 630, *1182*
 LONG, D. C. DE, 1013, *1182*
 LONGWELL, A. C., 904, *1182, 1214*
 LOOMIS, W. F., 665, 744, *1183*
 LOOSANOFF, V. L., 737, 889, 901, 903, 904, 906, 908, 911-913, 916, 918, 919, 924-928, 945, 949, 962, 966, *1144, 1154, 1183, 1185*

- LOOSLI, J. K., 1086, *1187*
 LOPEZ, E., 1028, *1152*
 LOPEZ, N. N., 955, *1190*
 LOPP, R. J., 1093, 1095, *1187*
 LORD, H., 934, *1134*
 LU, Y. J., 1023, 1027, *1181*
 LUCAS, C. E., 616, *1183*
 LUCAS, F. A., 1095, *1183*
 LUDWIG, H., 949, 957-960, *1183*
 LUDWIG, H. W., 724, *1183*
 LUDWIG, W., 724, *1183*
 LUEKEN, W. W., 603, 624, *1183*
 LUMARE, F., 857, 1028, *1183, 1221*
 LUND, D. S., 913, 914, 930, *1156, 1183*
 LUNTZ, A., 679, 685, 690, *1183, 1184*
 LUNZ, G. R., 858, *1184*
 LUQUET, P., 1013, *1206*
 LUTZ, R. A., 906, *1184*
 LUTZE, G. F., 600, *1184*
 LWOFF, A., 601, 765, *1184*
 LYMAN, J., 589, *1184*
 LYNCH, D. D., 1094, *1185*
 LYNCH, W. F., 715, *1184*
 LYTLE, C. F., 652, *1184*
- MAAS, O., 630, 631, 635, *1184*
 MACANDREW, R., 949, 950, *1184*
 MCARTHUR, R. H., 987, *1184*
 MCBRIDE, A. F., 1121, *1184*
 MCBRIDE, E. W., 957, 959, *1184*
 MCCALLION, D. J., 989, *1178*
 MCCAULEY, J. E., 954, *1215*
 MCCCLARY, A., 652, *1184*
 MCCLEAVE, J. D., 1004, *1229*
 MCCLOSKEY, L. R., 728, *1184*
 MCCONNAUGHY, R. A., 961, *1137*
 MCCONNELL, S. C., 1023, *1193*
 MACDONALD, R., 810, *1185*
 MCENERY, M., 596-598, 605, 702, 706, 708,
 1180
 MCGEER, P. L., 1053, *1193*
 MACGINITIE, G. E., 742, 948-952, *1185*
 MACGINITIE, N., 949-952, *1185*
 MCGINN, M. P., 590, 591, 622, *1185*
 MCGINNES, S. M., 1073, 1075, *1185*
 MACHIN, D., 859, *1159*
 MCINERNEY, J. E., 1021, 1022, *1185*
 MACINNES, J. R., 934, *1136*
 MACINTOSH, F. C., 583, 1076, *1138, 1169*
 MCINTOSH, W. C., 727, *1185*
 MCKEE, T. B., 1005, 1006, *1179, 1211*
 MACKENZIE, B. A., 1097, 1098, *1151*
 MACKENZIE, C. L., JR., 919, 932, 933,
 1185
 MACKIE, G. O., 652, 660, 661, *1172, 1185*
 MACKINNON, D. L., 585, 592, *1185*
- MCLAIN, L. R., 1017, *1229*
 MCLAREN, I. A., 767, 782, 783, 786, 794,
 1054, 1099, 1117, 1119, *1141, 1182, 1185*
 MCLARNEY, W. O., 845, 846, 855, 859, 871,
 873, 886, 889, 895, 896, 901, 902, 924, 931,
 933, 1005, 1006, 1009-1012, 1020, *1123*
 MCLAUGHLIN, J. J. A., 586, 587, 596, 597,
 611, 612, 622, 626, *1180, 1199*
 MCMMASTER, M. F., 679-683, 689, *1217*
 MCMYNN, R. G., 977, 978, *1185*
 MACNAE, W., 949, *1185*
 MCNALLY, J., 1094, *1185*
 MCQUEEN, A., 1017, *1132*
 MCV EY, J. P., 978, 1007, 1023, *1187*
 MADDEN, W. D., 1024, 1027, *1210*
 MADSEN, F. J., 950, 951, *1185, 1186*
 MAGEE, W. T., 1013, *1229*
 MAGGENTI, A. R., 685, *1146*
 MAGNUS, D. B. E., 948, *1186*
 MAGUIRE, T. D., 1037, *1196*
 MALEK, S. R. A., 857, *1186*
 MALORNY, G., 1083, *1186*
 MALSEN, H. F. VON, 734, *1186*
 MAMKAEV, I. V., 671, *1186*
 MANACOP, P. R., 1007, *1186*
 MANN, H., 1008, *1186*
 MANN, K. H., 946, *1189*
 MANSFIELD, A. W., 1036, 1117, *1186, 1204*
 MANSUETI, A. J., 977, *1145*
 MANTON, I., 670, 1131, *1199*
 MANTON, V. J. A., 1068, 1078, 1080, *1186*
 MAPSTONE, G. M., 894, *1186*
 MARCUS, E., 713, 715, *1186*
 MARISCAL, R. N., 664, *1186*
 MARR, J. C., 971, *1186*
 MARSH, M. C., 1016, *1154*
 MARSHALL, S. M., 661, 770, 771, 791, *1186*
 MARTEN, G. G., 986, *1186*
 MARTIN, H. B., III, 1060, *1222*
 MARTIN, J. H., 1120, *1187*
 MASON, J., 901, *1187*
 MASON, S. G., 583, *1138*
 MAST, E. C., 616, 617, *1187*
 MASTROPAOLO, C., 696, *1217*
 MASTROPAOLO, C. A., 613, 626, 1118, *1180*
 MASUDA, I., 1018, *1126*
 MATHISEN, O. A., 1093, 1095, *1187*
 MATSUURA, D. T., 1073, 1075, *1187, 1225*
 MATTHEWS, A., 662, *1187*
 MATTHEWS, D. C., 652, *1187*
 MATTHEWS, L. H., 1103, 1117, 1119, *1125,*
 1162, 1187
 MATTHIESSEN, G. C., 901, *1187*
 MATUTANI, K., 945, *1190*
 MAUPAS, E., 679, 690, *1187*
 MAXWELL, P. D., 1054, *1187*

- MAY, R. C., 968, 972, 976-978, 987, 1007, 1023, 1179, 1187
MAYER, M., 585, 1187
MAYER, P., 849, 1187
MAYNARD, L. A., 1086, 1187
MEAD, A. D., 859, 864, 949, 1187
MECKLENBURG, T. A., 965, 1187
MEDCOF, J. C., 949, 1147
MEDEM, F., 898, 900, 1187
MEDNIKOV, B. M., 777, 1187
MEEK, A., 859, 1187
MEIXNER, R., 842, 930, 1187, 1188
MENDELSON, L., 954, 1126
MENGE, B. A., 958, 960, 1188
MENON, N. R., 716-718, 1188
MENU-MARQUE, S. A., 849, 851, 1188
MENZEL, R. W., 582, 1215
MERCADO, P., 843, 1188
MERGNER, H., 627, 1188
MERICAN, A. B. O., 844, 1182
MERLIN, E. J., 602, 606-610, 625, 626, 1212
MERTZ, E. T., 1013, 1015, 1182, 1188
MESKE, C., 1027, 1188
MESTER, R., 1023, 1188
METZ, C. B., 964, 1188
MEYER, D. L., 948, 1188
MEYERS, S. P., 583, 692-694, 697, 698, 706, 707, 709-711, 836, 882, 1166, 1167, 1188, 1209
MEYER-WAARDEN, P. F., 841, 1188, 1189
MICHELSON, E. H., 895, 1189
MIGAKI, G., 1120, 1220
MILISEN, K. K., 1023, 1024, 1210
MILKMAN, R., 970, 1189
MILLER, C. A., 602, 1189, 1221
MILLER, H. M., 679, 686, 1189
MILLER, J. E., 880, 1140
MILLER, R., 651, 1189
MILLER, R. J., 946, 1189
MILLER, R. M., 1110, 1189
MILLER, R. S., 785, 1201
MILLER, W. S., 906, 913, 916, 1183
MILLIGAN, H. N., 949, 950, 1189
MILLS, E. L., 948, 1206
MINASIAN, L. L., 877, 878, 1215
MINER, R. W., 728, 1189
MITCHELL, C. W., 679, 690, 1189
MITCHELL, E. D., 1114, 1124
MITO, S., 977, 1189
MITSON, R. B., 755, 1189
MIURA, T., 881, 1189
MIYAMURA, M., 837, 852, 854, 1167
MIYAZAKI, I., 925, 926, 1189
MIZUNO, M., 1018, 1195
MOAV, R., 1032, 1297
MOCK, C. R., 753, 814, 837, 853, 1189
MODIN, J. C., 851, 852, 1189
MÖLLER, T. H., 583, 833, 915, 1172
MÖEWUS, L., 607, 1189
MOHAMED, K. H., 856, 858, 1189
MOHR, E., 1054, 1117, 1119, 1189
MOKRETSOVA, N. D., 937, 1189
MONROE, R. J., 881, 1139
MONROY, A., 938, 1189
MONTGOMERY, M. C., 894, 1152
MOODIE, C. F., 776, 781, 782, 794, 1173
MOORE, D. V., 895, 1190
MOORE, H. B., 954, 955, 1190
MOORE, H. F., 638-640, 901, 1190
MOORE, J. A., 661, 1190
MOOTZ, C. A., 839, 876, 936, 1149, 1190
MORALES, P., 858, 1190
MORGAN, R. P., II, 877, 1152
MORGAN, T. H., 661, 1190
MORI, S., 945, 1190
MORI, Y., 679, 818, 820, 837, 853, 1166, 1190
MORIMOTO, Y., 820, 1190
MORIOKA, T., 1028, 1228
MORO, L., 690, 1190
MORRIS, D., 1054, 1170
MORRIS, J. C., 1077, 1149
MORRIS, R. W., 968, 971, 976-978, 1190
MORSE, M., 661, 1190
MORTENSEN, T., 938, 949-951, 953, 955, 957, 959, 960, 963, 1190, 1191
MOTOMURA, I., 940, 1191
MOTT, J. C., 807, 1200
MOUNIB, M. S., 1029, 1030, 1191
MOUSSATCHÉ, H., 965, 1191
MOYSE, J., 800, 801, 806, 1191
MROZ, E., 857, 1219
MÜLLER, H., 731, 1191
MÜLLER, W. A., 651, 659, 666, 667, 1191
MULLER, W. A., 596-599, 605, 702, 706, 708, 1180, 1191, 1198
MULLIN, M. M., 771-773, 783-786, 791, 792, 794, 1191, 1192
MUNDEY, G. R., 859, 1192
MUNFORD, J. G., 583, 746, 833, 915, 1172
MURAKAMI, S., 959, 1192
MURAYAMA, S., 889, 898, 1192
MURCHELANO, R. A., 917, 1192
MURDOCH, W. W., 985, 986, 1192, 1194
MURKEN, J., 924, 936, 1192
MURPHY, B., 857, 1217
MURPHY, D. G., 692, 696, 698, 700, 704, 710, 711, 1138, 1167
MURPHY, H. E., 786, 1192
MURPHY, M. A., 837, 884, 1141, 1158
MURRAY, J. W., 596, 1192
MUSCATINE, L., 641, 665, 666, 1180
MUSICK, R. S., JR., 962, 1137

- MUUS, B. J., 726, *1192*
 MUUS, K., 651, *1192*
 MYERS, E. H., 596, 597, *1192*

 NACHTSHEIM, H., 734, *1192*
 NAGAI, S., 664, *1192*
 NAGAI, Y., 664, 953, *1192*
 NAGAO, Z., 651, *1192*
 NAKAJIMA, M., 1093, *1192*
 NAKAMURA, K., 823, 827, 828, 832, *1175, 1211*
 NAKAMURA, T., 952, 953, *1192, 1218*
 NAKANISHI, Y. H., 755, *1192*
 NAPOLITANO, R., 610, 625, *1193*
 NARCHI, W., 654, *1193*
 NASH, C. E., 745, 754, 755, 1022-1024, *1177, 1178, 1193*
 NASH, C. F., 1007, *1210*
 NASSOGNE, A., 763, 767, 777-781, 785, 790, 793, *1193*
 NASSONOV, N. B., 630, *1193*
 NATHAN, H. A., 590, 686, *1168, 1193*
 NEAL, R. A., 814, *1189*
 NEEHDAM, J. G., 584, 585, 738, 901, *1193*
 NEEDLER, A. W. H., 949, *1193*
 NEFF, J. A., 1093, 1096, *1207*
 NELSON, D. A., 934, *1136*
 NELSON, E. W., 584, 770, 940-942, *1125*
 NELSON, T. C., 926, *1193*
 NESTEROV, G. A., 1093, 1095, *1193*
 NEUGEBAUER, W., 1104, 1107, 1119, *1193*
 NEUNES, H. W., 684, 763, 777, 778, 793, *1193*
 NEWELL, G. E., 722, 727, *1193*
 NEWMAN, H. H., 964, *1193*
 NEWMAN, M. A., 1053, 1088, 1111, *1165, 1193*
 NEWMAN, V. A., 848, *1193*
 NEWMAN, W. A., 881, *1157*
 NEZ, M. M., 896, *1172*
 NICHOLAS, W. L., 691, *1193*
 NICHOLS, D., 937, 939, 948, *1193*
 NICHOLS, D. H., 915, *1153*
 NICKELSON, R., 857, *1219*
 NICOL, E. A. T., 742, *1193*
 NIKITINSKAYA, I. V., 978, *1193*
 NIKOLYUKIN, N. I., 1031, *1204*
 NIMURA, Y., 744, 745, 753, *1193*
 NISHII, T., 906, *1178*
 NISHIKAWA, N., 926, *1169*
 NISHIWAKI, M., 1041, 1053, 1093-1097, 1099, 1109, 1121, *1193, 1194*
 NONNENMACHER-GODET, J., 691, *1194*
 NORMAN, K., 823, *1215*
 NORMANDIN, R. F., 913, *1138*
 NORRIS, K. S., 1036, 1038, 1039, 1042, 1053, 1060, 1110, 1121, *1135, 1194*
 NORTON, T. A., 713, 715, *1194*
 NOSE, T., 1015, 1017, 1028, *1126, 1162, 1194*
 NOUMURA, T., 962, *1172, 1194*
 NOUVEL, L., 841, *1194*
 NOVIKOFF, A. E., 733, *1194*
 NOWAK, W. S. W., 860, *1194*
 NOYES, B., 679, *1194*
 NUSSBAUM, M., 679, 690, *1194*
 NUZZOLO, C., 940, *1205*
 NYHOLM, K.-G., 597, *1194*

 OATEN, A., 985, *1194*
 ŌBA, T., 889, 897, 898, *1194*
 O'BRIEN, P. E., 919, *1165*
 OCHIAI, A., 1028, *1194*
 O'CONNELL, C. P., 982, 1034, *1194*
 O'CONNOR, C., 937, *1194*
 ODA, T., 1093, *1192*
 ODELL, D. K., 1118, *1194*
 ODUM, E. P., 628, *1194*
 ODUM, H. T., 628, *1194*
 OEHLER, R., 591, 595, *1194, 1195*
 ØRITSLAND, T., 1117, *1195*
 OGAWA, M., 1028, *1194*
 OGAWA, S., 679, 682, 689, *1166*
 OGINO, C., 1018, *1195*
 OGLESBY, L. C., 726, *1195*
 O'GRADY, F., 1003, *1154*
 OHATA, C. A., 1073, 1075, *1225*
 OHSHIMA, H., 956-958, *1195*
 OHSHIMA, Y., 952, 975-977, *1173, 1195*
 OKADA, H., 916, *1169*
 OKADA, K., 940, *1195*
 OKADA, Y. K., 648, *1195*
 OKAMOTO, R., 977, 979, *1195*
 OKAZAKI, K., 938, 941, *1195*
 OKIGAKI, T., 755, *1192*
 OKUNEVA, G. L., 679, *1220*
 OLCOTT, H. S., 1083, *1135, 1182*
 OLIVEREAU, M., 1027, *1195*
 OLLENSCHLÄGER, B., 1008, *1202*
 OLNEY, C. E., 1036, *1216*
 OLSEN, D. A., 1067, *1195*
 OLSON, J. B., 765, 789, *1171*
 OLST, J. C. VAN, 758, 851, 861, 863, 864, *1209*
 OMORI, M., 769, 772, 785, 792, 817, 858, 1028, *1195, 1228*
 ONBÉ, T., 785, 786, *1173*
 ONG, K. S., 846, 847, 871-873, 878, *1195*
 OOSAWA, T., 820, *1195*
 OPPENHEIMER, C. H., 837, 998, 1001, *1195, 1215*
 ORCUTT, H. G., 976, 977, *1195*
 ORON, R., 602-604, 606, 621, 623-625, *1172*
 ORR, A. P., 770, 771, 791, *1186*
 ORTON, J. H., 650, 897, *1195*
 OSANAI, K., 939, 940, 943, 965, *1195*

- OSTENSON, B. T., 1097, *1171*
 OSTERUD, H. L., 950, 958, 960, *1196*
 OTA, H., 1028, *1194*
 OTT, A. G., 1029, 1030, *1167, 1196*
 OTTO, R. G., 1016, *1196*
 OUSTERHOUT, L. E., 1083, *1210*

 PABST, B., 945, *1136*
 PACE, D. M., 616, 617, *1187*
 PAFFENHÖFER, G.-A., 651, 655, 772, 774, 785,
 791, 980, *1175, 1196, 1205*
 PAGE, J. W., 1019, *1125*
 PALINCSAR, E. E., 615, 651, *1196*
 PALINCSAR, J. S., 651, *1196*
 PALKO, B. J., 977, 978, *1203*
 PALMER, L., 961, 964, 965, *1196*
 PANDIAN, T. J., 585, 628, 742, 772, 838, 900,
 935, 937, 944, 946, 948, 954, 981, 986,
 1019, *1196*
 PANINA, G. K., 1093, 1095, *1196*
 PAPE, A., 1031, *1196*
 PARKER, G. H., 630, *1196*
 PARKER, J. C., 814, *1196*
 PARODIZ, G., 949, *1137*
 PARSONS, J., 931, *1196*
 PARSONS, T. R., 595, *1196*
 PATASHNIK, M., 1104, *1196*
 PATEL, B., 802, *1143, 1196*
 PAULBITSKI, P. A., 1037, 1038, *1196*
 PAULIAN, P., 1117, *1196*
 PAULSON, T. C., 894, *1196*
 PAVILLON, J.-F., 946, *1196*
 PAVLOVSKAYA, T. W., 603, 620, *1196*
 PAWSON, D. L., 948, *1197*
 PEARCY, W. C., 858, *1197*
 PEARCY, W. G., 812, *1197*
 PEARSE, J. S., 946, 950, 953, *1197*
 PEARSE, V. B., 662, 946, *1197*
 PEARSON, A. K., 1117, *1149, 1197*
 PEARSON, J. C., 858, 952, *1197*
 PEARSON, O. P., 1117, *1149*
 PEARSON, R. G., 952, *1197*
 PENNOCK, J. F., 591, 622, *1147*
 PEPPER, R. L., 1060, *1197*
 PÉQUIGNAT, E., 946, 947, *1197*
 PEREZ, C., 648, *1197*
 PEREZ-FARFANTE, I., 858, *1197*
 PÉREZ PEREZ, D., 858, *1197*
 PERKINS, E. J., 726, *1197*
 PERRIER, E., 958, *1197*
 PERSOONE, G., 604, 621, 623-625, 744-746,
 748, 750-753, 756, 759, *1145, 1197, 1213*
 PERTZOFF, V., 633, *1154*
 PETERSON, R. S., 1054, 1075, 1117, 1118,
 1121, *1161, 1169, 1197, 1198*
 PETTIBONE, M. H., 728, *1198*

 PEYTON, L. J., 1075, *1169*
 PFANNENSTIEL, H.-D., 731, *1198*
 PFISTER, R. N., 585, 586, 622, *1157*
 PHIBBS, F. D., 927, *1133*
 PHILLEO, W. W., 1024, *1146*
 PHILLIPPI, R. A., 958, *1198*
 PHILLIPS, A. M., JR., 1016, *1198*
 PHILLIPS, G. C., 847, 848, 1010, *1198*
 PHILLIPS, J., 946, *1149*
 PHUMIPHOL, S., 879, *1219*
 PIANKA, E. R., 987, *1184*
 PIATIGORSKY, J., 955, *1198*
 PIC, C., 1013, *1219*
 PICKFORD, G. E., 1023, 1028, *1127, 1198*
 PIERCE, S., 596, 597, 605, 702, *1152, 1180, 1198*
 PIKE, G. C., 1095, *1198*
 PILKINGTON, M. C., 887, *1198*
 PILKINGTON, M. C., 889, 891-893, *1198*
 PILLERI, G., 1049, 1058, 1089, 1092, 1110,
 1111, *1156, 1198*
 PILSON, M. E. Q., 1103, 1111, 1112, *1198*
 PINCEMIN, J. M., 616, *1198*
 PINNER, T. C., 1087, 1104, 1106, *1199*
 PLAGMANN, J., 841, *1198*
 PLESNER, P., 601, *1180*
 POIRIER, L., 924, *1198*
 POIZAT, C., 895, *1198*
 POLO, G., 765, 789, *1179*
 POMEROY, L. R., 628, *1171*
 PONGOLINI, G.-F., 684, 763, 777, 778, 788,
 793, *1193*
 PONOMAREVA, L. A., 811, *1198*
 POPE, J., 980, 1013, *1142*
 POPE, J. A., 1015, *1142*
 POPOV, G. V., 991, *1198*
 POPPER, D., 978, 1007, 1023, *1130, 1187, 1198*
 POSTON, H. A., 1022, *1199*
 POULET, S. A., 783, *1199*
 POULTER, T. C., 1045, 1087, 1104, 1106, *1199*
 POURBAIX, N., 628, 629, *1199*
 POURNELLE, G. H., 1064, 1077, 1092, *1199*
 POURRIOT, R., 686, 690, *1199*
 POWELL, H. T., 806, *1128*
 POWER, M. J. D., 799, 800, 805, 807, *1218*
 POWNALL, P. C., 858, *1199*
 PRAGER, J. C., 747, *1229*
 PRAMER, D., 612, *1137*
 PRESCOTT, J. H., 1047, 1069, *1199*
 PRESLAN, J. E., 612, 626, *1160*
 PRIM, P., 945, *1199*
 PRINGSHEIM, E. G., 431, 585, 588, *1199*
 PRIOR, F. T., 999, 1001, 1003, 1004, *1215*
 PROUHO, H., 713, 715, *1199*
 PROVASOLI, L., 585-588, 596, 597, 611, 612,
 620, 622, 626, 669, 670, 672, 756, 763, 775,
 788, *1168, 1199, 1210*

- PROVENZANO, A. J., JR., 581, 877, 1163, 1199
 PRUDER, G., 936, 1149, 1162
 PRUGININ, Y., 1032, 1200
 PRYTHERCH, H. F., 901, 906, 1200
 PUCKETT, W. O., 660, 1200
 PÜTTER, A., 630, 1200
 PULLIN, R. S. V., 1030, 1200
 PUNNETT, R. C., 690, 1200
 PURDIE, P., 1112, 1200
 PURDOM, C. E., 1031, 1200
 PYEFINCH, K. A., 807, 1200

 QASIM, S. Z., 976, 977, 1200
 QUATREFAGES, D. DE, 959, 1200
 QUAYLE, D. B., 901, 930, 932, 1200

 RABANAL, H. R., 856, 1145
 RADAKOV, D. V., 990, 991, 1200
 RAE, B. B., 1097, 1200
 RAINBOW, P. S., 807, 1221
 RAINE, G. E., 861, 877, 1207
 RAJA BAI NAIDU, K. G., 878, 1200
 RAMAIAH, G. D., 1103, 1105, 1126
 RAMENOFKY, M., 881, 1200
 RAND, R. W., 1093, 1094, 1103, 1117, 1119, 1200
 RAO, M. R. R., 602, 1221
 RAO, M. V. N., 592, 1200
 RAPHAEL, Y. I., 878, 1200
 RASALAN, S. B., 856, 1132, 1136
 RASMONT, R., 627, 629, 635, 1201
 RASMUSSEN, B., 950, 952, 1117, 1201
 RASMUSSEN, L., 601, 1166
 RATHBÜN, R., 859, 1201
 RAUCH, H. E., 883, 1132, 1201
 RAUSCHENPLAT, E., 726, 728, 743, 1201
 RAY, C., 1038, 1039, 1042, 1073, 1074, 1201
 RAY, G. C., 1060, 1222
 RAYMOND, L. P., 982, 1034, 1194
 RAYMONT, J. E. G., 770, 779, 785, 786, 1201
 RAYNOR, J., 597, 1180
 REDDY, J. R., 616, 1201
 REED, S. A., 663, 1201
 REES, G. H., 876, 1201
 REES, W. J., 651, 652, 660, 1201, 1205
 REESE, E. S., 581, 1201
 REEVE, M. R., 847, 1201, 1202
 REGNAULT, M., 842, 1202
 REIBENBACH, Z., 602-604, 606, 621, 623-625, 1172
 REICH, K., 591, 1202
 REICHENBACH-KLINKE, H.-H., 1008, 1202
 REICHLÉ, R., 1118, 1173
 REILLY, S. M., 602, 1202
 REIMER, A., 663, 1202
 REINECK, M., 1107, 1202
 REISH, D. J., 734, 736, 1130, 1202
 REISINGER, E., 652, 658, 1202
 REISWIG, H. M., 628-630, 1202
 REITZENSTEIN, A. VON, 650, 1202
 REMANE, A., 725, 1202
 RENÉ, F., 621, 1203
 RENFRO, W. C., 847, 1203
 RENSBERGER, B., 859, 1203
 RENSHAW, R. W., 651, 652, 665, 666, 1224
 REVENTLOW, A., 1107, 1203
 REYNOLD, G. S., 1060, 1203
 RHODES, E. W., JR., 912-914, 1203
 RIBI, G., 945, 1136
 RICE, A. L., 814, 877, 1199, 1203
 RICE, C. E., 1054, 1121, 1161
 RICE, D. W., 1098, 1203
 RICHARDS, W. J., 977, 978, 1167, 1203
 RICHMAN, S., 770, 1203
 RICKETTS, E. F., 959, 1203
 RIDGWAY, G. J., 1030, 1166
 RIDGWAY, S. H., 1036-1038, 1040, 1044, 1047, 1053, 1060, 1067, 1070, 1071, 1093, 1108, 1110, 1121, 1162, 1189, 1203, 1227
 RIEMANN, F., 692, 1155
 RIESER, R. A., 859, 1159
 RIETBROCK, N., 1083, 1186
 RIGDON, R. H., 1086, 1203
 RIKER, A. J., 696, 1172
 RILEY, J. D., 748, 749, 751, 752, 922, 1031, 1203, 1210
 RILEY, J. P., 760, 1165
 RIVKIN, S., 921, 1147
 RISEBROUGH, R. W., 1120, 1187
 ROBERTS, J. M., 1117, 1162
 ROBERTS, M. H. JR., 821, 824-826, 877, 1203
 ROBERTS, R. J., 1017, 1132
 ROBERTSON, P. B., 871, 873, 1203
 ROBERTSON, T. B., 616, 1204
 ROCH, F., 651, 656, 1204
 RODENHOUSE, I., 951, 1204
 ROELS, O. A., 582, 1127, 1155, 1204, 1215
 RÖTTGER, R., 596, 600, 601, 1204, 1213
 ROGERS, J. N., 770, 1203
 ROLLEFSEN, G., 747, 968, 1204
 ROMASHOV, D. D., 1031, 1204
 RONALD, K., 1036, 1204
 ROOT, F. M., 615, 1204
 ROS, R., 1023, 1188
 ROS, R. M., 858, 1197
 ROSE, J. A., 849, 1167
 ROSE, R. A., 962, 1138
 ROSE, S. M., 661, 989, 1204
 ROSEN, D. E., 1021, 1133
 ROSENBAUM, N., 601, 1166
 ROSENTHAL, H., 969, 975, 980, 982, 983, 986, 991-997, 1007, 1008, 1024, 1029, 1032, 1033, 1167, 1204, 1205, 1224, 1225

- ROSS, C. A., 601, *1205*
 ROSS, L. A., 884, *1158*
 ROTH, J. S., 617, *1205*
 ROTHBARD, S., 1032, *1200*
 ROTHSCHILD, LORD, 940, *1219*
 ROTRAMEL, G., 808, *1205*
 ROTHHAUWE, H.-W., 878, *1175*
 ROWE, R. J., 922, *1203*
 ROWLANDS, I. W., 1117, 1119, *1125*
 RUBIN, H., 596, 597, *1180*
 RUBINOFF, I., 976-978, *1145, 1205*
 RUBINOFF, R. W., 976-978, *1145*
 RUDZINSKA, M. A., 615, *1205*
 RUE, G. R., LA, 739, *1205*
 RULLIER, F., 724, *1205*
 RULLMAN, J., 596-598, 696, 698, 702, 703, 706, 708, 709, 712, *1180, 1217*
 RUMIANZEFF, A., 690, *1205*
 RUNNELS, R. A., 1086, *1205*
 RUNNSTRÖM, J., 939, 940, 943, *1205*
 RUSSELL, F. S., 645, 651, 652, *1201, 1205*
 RUTHERFORD, C. L., 666, *1205*
 RUTHERFORD, J. C., 957, *1205*
 RUTHVEN, J. A., 620, *1206*
 RYAN, E. P., 580, 897, *1139, 1206*
 RYDER, J. A., 901, *1206*
 RYLAND, J. S., 713-715, *1206*
 RYTHER, J. H., 612, 626, 845, 846, 855, 859, 871, 873, 886, 889, 895, 896, 901, 902, 924, 931, 933, 1005, 1006, 1009-1012, 1020, *1128, 1159*

 SAAKYAN, S. A., 991, *1132*
 SABAUT, J. J., 1013, *1206*
 SACHS, B. D., 990, *1209*
 SADYKHOVA, I. A., 901, *1206*
 SAGARA, J., 926, 927, 949, *1169, 1206*
 SAISHO, T., 873, 1018, *1206*
 SAITO, T., 1018, *1126*
 SAKAI, S., 901, 916, *1169*
 SAKAMOTO, S., 1005, 1012, 1017, *1228*
 SAKSENA, V. P., 982, *1206*
 SALVINI-PLAWEN, L. v., 667, *1206*
 SAMAIN, J. F., 761, *1206*
 SAMUELSEN, T. J., 877, *1206*
 SANDERS, H. L., 948, *1206*
 SANDIFER, P. A., 849, *1206*
 SANDISON, E. E., 799, *1206*
 SARBER, H. R., 1099, *1169*
 SAROJINI, K. K., 1007, *1206*
 SARS, M., 949, 958, 960, *1206*
 SASSER, J. N., 691, *1206*
 SASTRY, A. N., 874, 875, *1206, 1207*
 SATIA, B. P., 1013, 1014, *1207*
 SATO, H., 889, *1290*
 SATO, R., 901, *1169*
 SATO, S., 787, 879, 880, *1207*
 SATO, T., 934, *1207*
 SAUNDERS, R. L., 1017, *1209*
 SAWAURA, K., 1093, *1192*
 SAWAYA, P., 966, *1125, 1207*
 SAWYER, T. K., 592, *1207*
 SAZHINA, L. I., 785, *1207*
 SCARRATT, D. J., 861, 877, *1207*
 SCHACH, H., 977, *1207*
 SCHÄPERCLAUS, W., 1008, 1010, *1207*
 SCHATZ, A., 669, *1168*
 SCHEFFER, T. H., 1098, *1207*
 SCHEFFER, V. B., 1054, 1073, 1093, 1096, 1117, 1120, *1174, 1207*
 SCHELTEMA, A. H., 890, 891, *1207*
 SCHELTEMA, R. S., 889-891, 894, 895, 897, *1196, 1207*
 SCHER, S., 590, *1168*
 SCHEVILL, W. E., 1075, *1208*
 SCHIMMEL, S. C., 758, 759, *1207*
 SCHINSKE, R. A., 946, *1214*
 SCHLIEPER, C., 584, *1207*
 SCHMIDT, O., 638, *1207*
 SCHMITT, W. L., 809, *1207*
 SCHMOLLER, H., 592, *1207, 1208*
 SCHNEIDER, D., 713, 715, 716, 718, *1208*
 SCHNEIDER, T., 867, *1208*
 SCHÖNE, C., 735, *1208*
 SCHÖNE, H., 743, *1208*
 SCHOENER, A., 954, *1208*
 SCHOENER, T. W., 582, *1208*
 SCHOLANDER, P. F., 1073-1075, *1208*
 SCHOLZ, A. J., 931, *1208*
 SCHONEWALD, J., 1120, *1220*
 SCHRAGE, M., 700, 701, 703, 704, 706-708, 710-712, *1155*
 SCHRANDT, R., 652, *1133*
 SCHROEDER, C. R., 1103, *1208*
 SCHRÖDER, G., 726, *1208*
 SCHULTE, E. H., 842, *1208*
 SCHULZ, D., 1004, *1208*
 SCHULZ, W., 735, *1208*
 SCHULZE, F. E., 630, *1208*
 SCHUSTER, W. H., 1006, *1208*
 SCHUSTERMAN, R. J., 1054, 1121, *1161*
 SCHUUR, A. M., 870, *1208*
 SCHUURMANS STEKHOVEN, J. H., 697, *1208*
 SCHWARZ, S., 684, *1208*
 SCHWARZ, W., 592, *1208*
 SEELEMANN, U., 887, 896, *1209*
 SEGAL, E., 943, 1021, *1209*
 SEGROVE, F., 732, *1209*
 SEIBOLD, E., 600, *1184*
 SEILACHER, A., 725, *1209*
 SELTZ, J., 1004, *1209*
 SENTZ-BRACONNOT, E., 724, *1209*

- SERAVIN, L. N., 671, *1186*
 SERFLING, S. A., 758, 851, 861, 863, 864, *1209*
 SERGEANT, D. E., 1091, 1118, 1119, *1209*
 SETOGUCHI, I., 926, *1209*
 SETTE, O. E., 971, *1209*
 SEWARD, M. J. B., 801, *1152*
 SGUROS, P. L., 692, *1209*
 SHANG, S. L., 1077, *1149*
 SHAPIRO, H., 938, *1209*
 SHAW, E., 990 *1209*
 SHAW, H. M., 1017, *1209*
 SHAW, P. D., 1003, *1157*
 SHEARER, C., 734, *1209*
 SHEHADEH, Z. H., 1007, 1022-1024, 1027, 1030, *1177, 1178, 1209, 1210*
 SHELBORNE, J. E., 748, 749, 751-755, 968, 977, 981, 998, 1001, 1004, 1019, *1134, 1210*
 SHELL, E. W., 1032, *1210*
 SHEN, C. J., 849, *1210*
 SHEN, T. H., 734, *1210*
 SHIBKO, S. I., 1006, 1008, *1152*
 SHIFRINE, M., 1083, *1210*
 SHIGENO, K., 824, 827-832, 837, 838, 852, *1145, 1210*
 SHIMAYA, M., 746, 835, *1172, 1210*
 SHIPLEY, D. D., 966, *1183*
 SHIRAIISHI, K., 756, 763, 788, *1199, 1210*
 SHIRAIISHI, Y., 1022, *1210*
 SHLESER, R., 883, *1201*
 SHLESER, R. A., 859, 861, 863-865, 868, 870, 883, *1132, 1163, 1210, 1211*
 SHOKITA, S., 846, *1211*
 SHOOP, C. T., 1004, *1134*
 SHORT, R. B., 896, *1172*
 SHUDO, K., 823, 827, 828, 832, *1175, 1211*
 SHULL, A. F., 679, 690, 691, *1211*
 SIBUYA, S., 926, *1175*
 SICK, L. V., 754, 824, 833, 834, 836, 882, *1125, 1211*
 SIMIZU, Z., 926, *1175*
 SIMMS, J., 692, *1209*
 SIMPSON, A. C., 879, *1211*
 SIMPSON, B., 1016, *1154*
 SIMPSON, J., 1053
 SIMPSON, J. G., 957, 1104, 1120, *1145, 1184, 1211*
 SIMPSON, J. J., 950, 951, *1211*
 SIMPSON, T. L., 628, 630, *1211*
 SINCLAIR, M. E., 631, 635, *1130*
 SINGH, B. N., 595, *1211*
 SINIFF, D. B., 1118, *1173*
 SINNHUBER, R. O., 1005, 1016, *1179, 1211*
 SIRINE, G. F., 583, *1188*
 SIVERTSEN, E., 1103, 1119, 1120, *1211*
 SLADEN, W. P., 949, *1211*
 SLAVIN, J. W., 1084, *1211*
 SLEPTSOV, M. M., 1117, 1119, *1211*
 SLIJPER, E. J., 1111, 1118, 1119, *1211, 1212*
 SLIPP, J. W., 1054, *1207*
 SLOBODKIN, L. B., 664, 760, *1212*
 SLOPER, J. C., 1117, 1119, *1125*
 SLUITER, C., 950, *1212*
 SMITH, A. W., 1120, *1220*
 SMITH, E. A., 958, 959, 1117, *1212*
 SMITH, E. H., 957, *1212*
 SMITH, G., 806, *1212*
 SMITH, G. J. D., 1113, *1212*
 SMITH, H. W., 1076, *1212*
 SMITH, K. L., JR., 728, *1152*
 SMITH, L. L., JR., 758, *1125*
 SMITH, L. S., 950, *1212*
 SMITH, P. B., 906, 913, 916, *1183*
 SMITH, R. A., 757, *1212*
 SMITH, R. H., 962, *1137*
 SMITH, W. C., 859, *1212*
 SMITH, W. L., 584, *1212*
 SNEED, K. E., 1013, 1030, 1031, *1147, 1212, 1214*
 SNIESZKO, S. F., 1008, 1017, *1212*
 SOH, C. L., 1007, *1212*
 SOHONIE, K., 1085, *1145*
 SOKOLOV, V. YE., 1075, 1121, *1212*
 SOKOLOVA, M. N., 951, *1212*
 SOLBERG, B., 685, 686, 735, *1146*
 SOLDI, A. T., 602, 606-610, 625, 626, *1212, 1213, 1221*
 SOLEIM, P. A., 971, 977, *1213*
 SOLLAUD, E., 849, *1213*
 SORGELOOS, P., 744-748, 750-753, 756, 759, 761, *1130, 1197, 1213*
 SOROKIN, YU. I., 629, 664, 981, *1213*
 SOTTILE, W., 628, *1171*
 SOUTHWARD, A. J., 807, *1141*
 SOUTHWARD, E. C., 807, *1141*
 SPANGENBERG, D. B., 642, 643, *1213*
 SPARROW, B. W., 747, 786, 807, *1141*
 SPAULDING, D. J., 1093, 1094, 1099, *1213*
 SPECTOR, W. S., 1112, *1213*
 SPENCER, B. E., 916, 921, 930, *1164, 1222*
 SPERLING, K. R., 1032, *1205, 1225*
 SPERRY, C. C., 1098, *1207*
 SPINDLER, M., 600, *1213*
 SPITTLER, P., 684, *1213*
 SPRAGUE, J. B., 1032, *1213*
 ŠRNA, R., 936, *1149, 1162*
 ST. AMANT, L. S., 856, 857, *1153, 1213*
 STACEY, N., 1029, *1167*
 STAINES, M. E., 994, 997, 998, *1132*
 STANBURY, F. A., 786, *1128*
 STANCYK, S. E., 954, 956, 963, *1213*
 STANLEY, J. G., 1031, *1214*
 STANSBY, M. E., 1083, *1135, 1182*

- STARK, J. N., 728, *1214*
 STEBBING, A. R. D., 713-715, *1206*
 STEELE, J. H., 791, 986, *1124, 1214*
 STEINBERG, M., 661, *1214*
 STEPHENS, G. C., 946, *1214*
 STEPHENS, K., 595, *1196*
 STEPHENSON, A., 661, *1214*
 STEPHENSON, R. R., 923, *1164*
 STEPHENSON, T. A., 661, *1186, 1214*
 STERBA, G., 621, *1214*
 STERBENZ, F. J., 602, 615, *1181, 1214*
 STEVENSON, J. C., 971, 972, *1214*
 STILES, S. S., 901, 904, *1182, 1214*
 STILLWELL, R. H., 616, 617, *1181, 1214*
 STIRLING, I., 1118, *1214*
 STONE, R. J., 596-598, 702, 706, 708, *1180*
 STONE, R. L., 802, 804, *1128*
 STRATHMANN, R., 718, *1214*
 STREET, R. J., 1094, *1214*
 STREHLER, B. L., 651, 655, *1134, 1214*
 STRICKLAND, J. D. H., 595, *1196*
 STRUHSAKER, J. W., 889, 894, 999, 1001,
 1003, 1004, *1214, 1215*
 STUDEBAKER, J. P., 648, 649, *1224*
 STUDER, T., 958, *1215*
 SUBRAHMANYAM, C. B., 837, *1215*
 SUDDITH, R. L., 652, 655, *1143, 1227*
 SUGII, K., 1085, *1215*
 SUGIURA, Y., 643, 644, *1215*
 SULKIN, S. D., 689, 822, 823, 877, 878, *1152,*
 1215
 SULLIVAN, J. J., 870, *1168*
 SUMICH, J. L., 954, *1215*
 SUND, O., 971, *1215*
 SUNDARARAJ, B. I., 1021, *1215*
 SUNDERLIN, J. B., 582, *1204, 1215*
 SUNDNES, G., 1075, *1173*
 SUNSHINE, P., 1104, *1177*
 SUSSEX, I. M., 938, *1148*
 SUTCLIFFE, W. H., JR., 871, *1215*
 SUTHERLAND, D. B., 1004, *1134*
 SUTTON, M. F., 734, *1215*
 SUZUKI, K., 1006, *1215*
 SWAN, E. F., 954, *1215*
 SWINGLE, H. S., 738, *1215*
 SYRETT, R., 758, *1130*

 TABB, D. C., 857, *1169*
 TACK, P. I., 1013, *1229*
 TAKAHASHI, R. M., 881, *1189*
 TAKANO, H., 763-766, 788, *1216*
 TAKEDA, N., 765, 777, *1216*
 TAKI, J., 945, 954, *1173*
 TAMAKAWA, M., 949, *1169*
 TAMPI, P. R. S., 1006, *1216*
 TAMURA, S., 962, *1169*

 TANAKA, K., 889, *1194*
 TANAKA, Y., 854, 948, *1216*
 TANAKA, Z., 952, *1195*
 TANAKAWA, N., 835, *1172*
 TANG, Y.-A., 1023, *1216*
 TAPPEL, A. L., 1083, *1135*
 TARAKANOV, V. I., 691, *1216*
 TARANTOLA, V., 615, *1181*
 TARANTOLA, V. A., 602, *1216*
 TARDENT, P., 660, 661, *1216*
 TARDENT, R., 661, *1216*
 TARUSKI, A. G., 1036, *1216*
 TAUSON, A. O., 691, *1216*
 TAVOLGA, M. C., 1121, *1216*
 TAYLOR, D. C., 1088, *1216*
 TCHOBANOGLOUS, G., 861, 863-865, *1168*
 TEMPLEMAN, W., 859-862, *1216*
 TENTCHOFF, M., 596, 597, *1180, 1198*
 TERAMOTO, K., 747, *1216*
 TERAQ, Y., 952, 953, *1218*
 TERRY, O. W., 867, *1138*
 TESCH, F.-W., 990, 991, 1005, 1022, *1217*
 TESHIMA, S., 835, *1172*
 THACKER, G. T., 748, 749, 751, 752, 1031,
 1203, *1210*
 THAMDRUP, H. M., 722, 726, *1217*
 THÉEL, H., 957, *1217*
 THEILACKER, G. H., 679-683, 689, 809-812,
 975-977, 987, *1179, 1197, 1217*
 THOMAS, C. D. B., 1073, *1182*
 THOMAS, G. L., 982, 983, 1034, *1168*
 THOMAS, H. J., 859, *1217*
 THOMAS, J. G., 732, 733, *1217*
 THOMAS, L. P., 950, *1217*
 THOMAS, M. K., 801, 804, *1173*
 THOMAS, M. M., 871, *1217*
 THOMPSON, R. J., 924, *1129*
 THOMSON, C. W., 958, 959, *1217*
 THORHAUG, A., 857, *1217*
 THORNTON, I., 934, *1133, 1134*
 THORNTON, K. R., 1065, *1166*
 THORSON, G., 742, *1217*
 THUN, W. VON, 700, 704, 705, 710, 711, *1217*
 THURBERG, F. P., 880, *1217*
 THURLEY, K. W., 1061, *1162*
 TICKELL, W. L. N., 1120, *1217*
 TIEBOR, J., 1048, *1147*
 TIEFENBACHER, L., 690, 691, *1135*
 TIETJEN, J. H., 596-598, 613, 626, 691, 692,
 695, 696, 698-703, 706, 708-712, *1180, 1217*
 TIEWS, K., 841, 842, 1006, 1013, *1217*
 TIEFFON, Y., 947, *1197*
 TIGHE-FORD, D. J., 799, 800, 802, 805, 807,
 1218
 TIMM, R. W., 702, 706, *1138, 1218*
 TIMOFEEVA, N. A., 1031, *1204*

- TOBIAS, W. J., 1007, 1218
 TOKUNAGO, T., 1083, 1218
 TOMLIN, A. G., 1075, 1218
 TOMLINSON, J. D. W., 1073, 1074, 1162
 TOTH, S. E., 651, 1218
 TOURNIER, H., 854, 1218
 TOWNSEND, C. H., 1045, 1218
 TOYAMA, T., 889, 1194
 TOYODA, T., 1018, 1126
 TRAUT, W., 734, 1218
 TRAVIS, D. F., 871, 872, 1218
 TREAT, D. A., 799, 1218
 TRIFONOVA, A. N., 970, 1218
 TRIGT, H. VAN, 628, 1218
 TRIPP, M. R., 934, 1143
 TROMMSDORFF, H., 1022, 1151
 TROMPETER, J., 698, 702, 703, 709, 712, 1217
 TRUSCOTT, B., 1029, 1030, 1218
 TSOY, R. M., 1031, 1218
 TSUDA, R. T., 1007, 1218
 TSUE, K. M., 692-694, 704, 709-711, 1188
 TSUJITANI, J., 591, 1218
 TSUNODA, N., 952, 953, 1218
 TURK, C., 936, 1149
 TURNBULL, F., 728, 1218
 TUSOV, J., 651, 654, 655, 1218
 TUTTLE, R. C., 590, 1218
 TUZET, O., 1027, 1218
 TYLER, A., 938, 940, 964, 965, 1218, 1219
 TYLER, B. S., 938, 965, 1219
 TZONIS, K., 734, 1219

 UBISCH, L. VON, 1031, 1219
 UCHIYAMA, K., 1120, 1219
 UENO, M., 1007, 1153
 UHLIG, G., 590, 602, 603, 622, 624, 625, 1219
 UKAWA, M., 977, 1189
 UKELES, R., 913, 923, 1165, 1219
 UKI, N., 897, 898, 900, 1174
 ULLREY, D. E., 1013, 1229
 ULMER, F. A., JR., 1092, 1117, 1219
 UMEDA, S., 1028, 1194
 UNGER, H., 962, 1219
 URRY, D. L., 782, 786, 793, 1141, 1219
 USHAKOV, B. P., 972, 1219
 USUI, A., 689, 1219
 UYE, S., 786, 1173

 VACQUIER, V. D., 940, 1219
 VAHLKAMPF, E., 591, 1219
 VAILE, D. C., 799, 800, 805, 807, 1218
 VALENTINČIČ, T., 952, 1219
 VALLE, M. R. DEL, 707, 1219
 VALLET, F., 1013, 1219
 VANDERZANT, C., 857, 1219

 VANNEY, C., 957, 1219
 VANVOORDE, E., 761, 1130
 VARIKUL, V., 879, 1219
 VASAL, S., 1021, 1215
 VASIL'eva, G. L., 679, 1220
 VASSILEVA-DRYANOVSKA, O., 1031, 1220
 VAUGHN, R. H., 1083, 1210
 VAZ-FERREIRA, R., 1118, 1220
 VEDAVYASA RAO, P., 847, 879, 1220
 VEDROS, N. A., 1120, 1220
 VEILLET, A., 806, 1220
 VEITCH, F. P., 919, 920, 1165, 1220
 VELSEN, F. P. J., 969, 1125
 VENABLES, L. S. V., 1119, 1220
 VENABLES, U. M., 1119, 1220
 VENKATARAMIAH, A., 820, 824, 825, 827, 833, 837, 838, 857, 1220
 VENOLIA, A. W., 1083, 1135
 VENTILLA, R. J., 620, 1158
 VERNBERG, J., 880, 1220
 VERNBERG, W. B., 880, 1220
 VERRILL, A. E., 728, 958, 1220
 VERWEY, J., 841, 1221
 VEVERS, H. G., 951, 954, 1221
 VIGLIERCHIO, D. R., 703, 706, 1143, 1221
 VILELA, M. H., 765, 870, 1150, 1221
 VILLADOLID, D. V., 856, 978, 1221
 VILLALUZ, D. K., 856, 1221
 VILLANI, P., 857, 1028, 1183, 1221
 VINCENCIO, Z. T., 1006, 1221
 VIRKAR, R. A., 946, 1214
 VLYMEN, L. L., 682, 1179
 VOLKMANN-ROCCO, B., 765, 789, 1129, 1221
 Vos, B. J., 1112, 1113, 1148
 VUILLEMIN, S., 724, 1221

 WADA, K., 1082, 1221
 WADA, S., 926, 1221
 WAGNER, A., 896, 1221
 WAGNER, E., 1008, 1221
 WAGTENDONK, W. J. VAN, 602, 608, 1189, 1212, 1213, 1216, 1221
 WAINWRIGHT, S. A., 628, 662, 1173, 1221
 WAKEFIELD, J. ST., 597, 1163
 WALKER, G., 800, 804-807, 1166, 1221
 WALKER, I., 606, 625, 1036, 1040, 1041, 1050, 1053, 1221
 WALKER, W. A., 1037, 1054, 1221
 WALLER, D. W., 1111, 1112, 1198
 WALLIS, A. P. L., 1066, 1068, 1081, 1222
 WALNE, P. R., 747, 894, 901, 904, 906-909, 911-919, 921-924, 930, 1222
 WALSBY, J. R., 728, 1222
 WALTERS, V., 1075, 1208
 WANGERSKY, P. J., 946, 981, 1222
 WARBURTON, F. E., 632, 633, 635, 1222

- WARD, J., 843, *1181*
 WARD, J. A., 950, *1222*
 WARD, W. W., 748, 749, *1222*
 WARE, S., 630, *1222*
 WARREN, P. J., 879, *1211*
 WARTZOK, D., 1060, *1222*
 WASSERTHAL, W., 651, 660, *1222*
 WATANABE, K., 682, 683, 689, *1166*
 WATANABE, M., 818, 820, 837, 853, *1166*
 WATANABE, T., 1018, *1195*
 WATERMAN, A. J., 733, *1222*
 WATERMAN, T. H., 813, *1222*
 WATLING, H., 934, *1133*
 WATSON, A. T., 725, 742, *1222*
 WATZKA, M., 690, *1222*
 WEBB, J. S., 934, *1134*
 WEBBER, H. H., 855, *1223*
 WEDGEFORTH, H. M., 1103, *1208*
 WEEL, P. B. VAN, 629, *1223*
 WEESE, A., 945, *1223*
 WEIL, I., 1077, *1149*
 WEILER-STOLT, B., 651, *1223*
 WELLER, C., 930, *1223*
 WELLS, G. P., 720, 722, 742, *1223*
 WELLS, H. W., 949, 951, *1223*
 WELLS, M. J., 949, 951, *1223*
 WELLS, W. F., 901, 911, *1223*
 WELSH, J. H., 966, *1223*
 WERMUTH, J. F., 655, *1223*
 WERNER, B., 641, 645, 647-649, 651-654,
 658, 665, 666, 722, 742, 760, 897, 937,
 1223, *1224*
 WERNER, E., 937, *1224*
 WEST, D. L., 651, 652, 665, 666, *1224*
 WESTERNHAGEN, H. VON, 970, 975, 993, 1007,
 1008, 1023, 1032, *1224*, *1225*
 WEYMOUTH, F. W., 858, *1225*
 WHITAKER, D. M., 745, *1171*
 WHITCOMB, J. B., 919, *1137*
 WHITE, D. B., 833, 834, 836, 882, *1211*
 WHITE, G. C., 1077, *1225*
 WHITE, J. R., 1086, *1225*
 WHITELOCK, O. v. ST., 685, *1225*
 WHITNEY, D. D., 679, 686, 690, 691, *1225*
 WHITNEY, P. J., 728, *1181*
 WHITTAKER, R. H., 616, *1225*
 WHITTING, H. W., 1047, *1158*
 WHITTLE, K. J., 966, *1225*, *1228*
 WHITTOW, G. C., 1073, 1075, *1187*, *1225*
 WICHTERMAN, R., 603, *1225*
 WICKETT, W. P., 970, *1125*
 WICKINS, J. F., 759, 760, 815, 844, 848, *1225*
 WIEBE, W., 628, *1171*
 WIEMAN, H. L., 728, *1141*
 WIESER, W., 691, *1225*, *1226*
 WILBER, C. G., 616, *1226*
 WILCKE, D. E., 742, *1226*
 WILKE, F., 1074, 1095, 1099, *1129*, *1226*
 WILKIE, D. W., 1045-1047, *1226*
 WILKINS, N. P., 987, *1226*
 WILLIAMS, B. G., 875, *1226*
 WILLIAMS, L. W., 859, *1226*
 WILLIAMSON, D. I., 814, 843, *1203*, *1226*
 WILLIAMSON, H. C., 841, *1226*
 WILSON, D. F., 768, 791, *1229*
 WILSON, D. P., 725, 734, 737, 901, 965, *1226*
 WILSON, E. A., 1117, *1226*
 WILSON, H. V., 631, 633, *1226*
 WILSON, K. W., 1033, *1227*
 WILTZIUS, W. J., 1029, *1227*
 WINN, H. E., 1036, *1216*
 WINTER, J. E., 921, 924, *1227*
 WISELY, B., 724, 800, 804, 805, *1227*
 WITTING, L. A., 1086, *1227*
 WOELKE, C. E., 934, *1227*
 WOHLFAHRTH, G., 1032, *1200*
 WOLFF, T., 950, *1135*
 WOLMAN, A. A., 1041, *1131*
 WOOD, E. M., 1010, *1227*
 WOOD, F. G., 1036, 1040, 1060, *1227*
 WOOD, J. W., 1006, *1211*
 WOOTTON, D., 958, *1227*
 WORMHOUDT, A. VAN, 848, *1227*
 WU, J. H., 696, *1172*
 WÜLKER, G., 591, *1227*
 WYTTENBACH, C., 652, 655, *1143*, *1227*
 YABLONSKAYA, E. A., 726, *1228*
 YACOWITZ, S., 954, *1126*
 YAMADA, M., 651, *1228*
 YAMADO, K., 1083, *1125*
 YAMAGUCHI, M., 949, 952, *1228*
 YAMAMOTO, K., 1028, *1228*
 YAMASU, T., 670, *1199*
 YAMAUCHI, K., 1028, *1228*
 YAMAZAKI, F., 1004, 1023, 1024, *1146*, *1228*
 YANAGIMACHI, R., 806, 940, *1228*
 YANG, W. T., 857, *1169*
 YASHOUV, A., 1023, *1228*
 YASUGI, R., 806, *1169*, *1228*
 YASUMASU, I., 941, 948, *1228*
 YASUNAGA, Y., 991, *1228*
 YOKOE, Y., 948, *1228*
 YONE, Y., 1005, 1012, 1017, *1228*
 YONGE, C. M., 725, 897, 901, *1228*
 YOSHIDA, M., 943, 955, *1228*
 YOSHIDA, T., 916, *1169*
 YOSHINAGA, H., 952, *1192*
 YOUNG, M. W., 949, *1228*
 YOUNG, S. D., 662, *1228*
 YU, T. C., 1005, 1006, *1179*, *1211*
 YUKI, R., 901, 926, *1169*, *1176*

- ZAFIRIOU, O., 966, 1228
ZAHRADNIK, J. W., 867, 868, 1208
ZALCMAN, D., 602, 604, 606, 621, 623-625, 1172
ZAMPETTI-BOSSELER, F., 955, 1228
ZAUGG, W. S., 1017, 1229
ZAWADOWSKY, M., 690, 1229
ZBINDEN, K., 1110, 1198
ZEIN-ELDIN, Z. P., 856, 857, 1229
ZEITOUN, I. H., 1013, 1229
ZELENY, C., 724, 1229
ZENKOVICH, B. A., 1112, 1229
ZIEGELMEIER, E., 722, 725, 742, 1229
ZILLIOUX, E. J., 747, 767-769, 786, 790, 791,
1185, 1229
ZIMMERMAN, S. T., 838, 839, 1229
ZIMMERMANN, M. A., 1004, 1229
ZSCHIECHE, A., 713, 715, 1229
ZUCKER, W., 600, 1180
ZUNARELLI, R., 690, 1154
ZWEIFEL, J. R., 976, 1177

TAXONOMIC INDEX

- abalones, 821, 886, 888, 889, 892, 895, 896, 900, 1169, 1174, 1180, 1192, 1194
- Abramis brama*, 1031
- Acanthamoeba*, 1166
- A. griffini*, 592, 1207
- Acanthaster*, 1156
- A. planci*, 949, 952, 1133, 1138, 1157, 1197, 1228
- Acanthephyra*, 858, 879, 1164
- A. purpurea*, 1152
- Acanthocephala*, 1168
- Acanthoecopsis* sp., 585-587, 622
- Acanthonchus cobbi*, 704
- Acartia*, 767-769, 820, 1229
- A. clausi*, 762, 767-769, 785-787, 790, 983, 1141, 1154
- A. longiremis*, 769
- A. tonsa*, 768, 769, 776, 785, 790, 791, 1229
- Acaulidae, 1130
- Acaulis*, 1130
- A. ilonae*, 651, 1134
- Aceola (aceols), 668, 669, 672, 677, 1126, 1133, 1146, 1177
- Achirus lineatus*, 987, 988
- Achnanthes*, 1007
- A. brevipes*, 596, 673
- Acropora*, 952
- A. bruggemanni*, 1127
- A. nasuta*, 952
- Actinomycetales, 999
- Actinotrocha branchiata*, 659, 1164
- Adamsia palliata*, 661, 1155
- Adoncholaimus thalassophygas*, 705, 710
- Aeolidiidae, 935
- Aequipecten irradians*, 701, 1206
- Aequorea coerulescens*, 651
- Aerobacillus colistinus*, 999
- Aerobacter aerogenes*, 592, 595, 602, 603, 624
- Aetea* sp., 718
- Aiptasia*, 1157
- A.* sp., 665, 1140
- akule, 1098
- Alcaligenes (Alkaligenes) faecalis*, 695
- Alcyonidium*, 713, 715, 716, 718
- A. hirsutum*, 715, 718
- A. mytili*, 1229
- A. polyorum*, 715, 718
- A.* sp., 716, 718
- Alcyonium digitatum*, 662, 1187
- Alderia modesta*, 887, 896, 1209
- alewives, 1084
- algae, 582, 584, 585, 591-594, 596, 597, 599-603, 605, 606, 611, 612, 620, 622, 626, 628, 630, 631, 634, 635, 650, 664, 665, 669-671, 678-680, 682-686, 691, 693-696, 698-703, 706, 709, 711, 715, 717, 718, 722, 724-726, 728, 729, 731, 734, 739, 746, 752, 753, 756, 757, 760, 761, 763, 764, 766-769, 774, 776-781, 783, 790, 795, 796, 798, 800, 801, 806, 807, 809, 814, 815, 817-819, 821, 878, 881, 884, 887, 889, 892-896, 901, 908-915, 917, 921-925, 935-937, 942, 943, 945, 947, 951-954, 967, 975-979, 1006, 1007, 1070, 1081, 1164, 1165, 1177, 1180, 1192, 1196, 1199, 1206, 1210, 1211, 1213, 1222, 1227
- algae, blue-green, 700, 701, 977, 978, 1006
- algae, brown, 952, 954
- algae, green, 690, 713, 719, 724, 731, 735, 785, 925, 952, 954, 978, 1006, 1189
- algae, red, 671, 945 952-954
- Allocentrotus fragilis*, 953, 1156, 1215
- Allogromia laticollaris*, 597-599, 1126, 1180
- A.* sp., 596
- allogromiids, 1180
- Alnus* sp., 808
- Alosa pseudoharengus*, 979
- A. sapidissima*, 1092
- Alpheidae (Crangonidae), 841, 1176
- Alpheus* (syn.: *Crangon*), 841, 1164
- A. armillatus*, 841
- A. heterochaelis*, 841, 1176
- A. normani*, 841
- Alternaria* sp., 694
- Ammodytes lanceolatum*, 1120
- A. tobianus*, 1089, 1120
- Ammonia beccarii tepida*, 596
- Amnodytidae, 1177
- amoebae, 591-596, 616, 618, 623, 1138, 1147, 1153, 1200, 1202, 1207, 1208, 1211, 1218, 1227
- Amoeba limax*, 1219
- Amorphina* sp., 637
- Amphacanthus oramin*, 1186
- amphibians, 1209
- Amphidinium*, 596, 619, 1148
- A. höfleri*, 587, 588, 622
- A. klebsii*, 821, 826
- Amphinema dinema*, 651
- A. rugosum*, 651
- amphineurans, 949
- Amphipholis squamata*, 959
- Amphiphora*, 1007
- Amphipleura*, 1006

- Amphipoda (amphipods), 653, 661, 726, 808, 881, 947, 975, 1007, 1099, 1224
Amphiprora paludosa, 596
A. paludosa var. *duplex*, 673
Amphitrite, 733, 1217
Amphiura chiajei, 954, 1135
A. filiformis, 1135
A. squamata, 1184
A. stimpsonii, 959
Amphora, 599, 978, 1006
A. purpusilla, 596
A. sp., 600, 695
Anabaena, 688
Anachis avara, 891, 1207
A. translirata, 891, 1207
Anadara broughtonii, 888, 892, 895, 926, 936, 1173, 1174
A. granosa, 936
A. subcrenata, 927, 936
Anaitides maculata, 726, 727
Analcidometra caribbea, 948
Anasterias, 958
A. antarctica, 958
A. studeri, 958
Anchoa mitchilli, 982, 987, 988, 1206
anchoveta, 1176
anchovy, 689, 854, 973, 982, 983, 994, 1010, 1034, 1085, 1094, 1096, 1100, 1109, 1168, 1177, 1217
anchovy, bay, 982, 987, 1206
anchovy, northern, 975, 1022, 1180, 1194
angler, 1179
Anguilla anguilla, 1004, 1005, 1015, 1027, 1149, 1152, 1162, 1177, 1188, 1208, 1221
A. japonica, 1015, 1017, 1028, 1126, 1162
A. rostrata, 1160, 1229
A. vulgaris, 1218
Anguillicula sp., 978
Ankistrodesmus, 688
Annelida (annelids), 583, 656, 720-742, 766, 815, 818, 853, 875, 878, 932, 935, 948, 952, 953, 979, 1007, 1033, 1096, 1130, 1146, 1147, 1153, 1159, 1163, 1164, 1166, 1167, 1171, 1175, 1177, 1185, 1202, 1221, 1222
Anochanus sinensis, 959
Anomia simplex, 901
Anomura, 813, 1162, 1199, 1206
anostracans, 743
Anseropoda *placenta*, 949
Antedon, 947
A. bitida, 1193
Anthocidaris crassispina, 941, 1228
Anthomedusae (anthomedusans), 651, 1134, 1223, 1224
Anthopleura midorii, 664
Anthozoa (anthozoans), 641, 661-665
Anticoma pellucida, 707
Anuraea aculeata, 684
Aphelenchoides marinus, 692, 694, 710
aphids, 1211
Aphrodite aculeata, 733, 1152
Apistonema sp., 593, 789
Aplacophora, 884
Aplysia aerophoba, 630
Aporocidaris milleri, 959
appendicularians, 981
Arachnidium hippothooides, 713
Arbacia, 964, 1162, 1176, 1196
A. lixula, 946, 964, 965, 1130, 1196
A. punctulata, 799, 804, 807, 941, 942, 945, 953, 961, 964, 965, 1209
A. sp., 874, 883, 977
Arca transversa, 901, 926
Archaeocyatha, 1222
A. angulatus, 600
A. sp., 599
Archaphanostoma agile, 668, 674, 677, 678
Archaster typicus, 955, 1139, 1195
Archannelida (archannelids), 734, 736, 1158, 1164, 1218
Archosargus rhomboidalis, 987, 988
Arctica islandica, 1227
Arctocephalus australis australis, 1055
A. australis galapagonensis, 1055
A. doriferus, 1055, 1094
A. forsteri, 1094, 1214
A. philippii townsendi, 1055
A. pusillus, 1055, 1090, 1094, 1103, 1116, 1200
A. tropicalis gazella, 1005, 1094
Arenicola cristata, 737
A. marina, 720-722, 737, 742, 821, 822, 826, 1177, 1193, 1223, 1229
Arenicolidae, 1223
Aristichthys nobilis, 845
ark, 1174
Armandia cirrosa, 724, 1159
A. salina, 583, 641-644, 652-658, 660-665, 669, 731, 743-761, 768, 781, 783, 791, 793, 794, 802, 803, 808-812, 815-828, 838-843, 847-849, 851, 853, 856, 857, 864, 871, 873-877, 879, 881-883, 977, 979-983, 993-997, 1007, 1020, 1023, 1127, 1130, 1132, 1139, 1148, 1152, 1156, 1164, 1165, 1170, 1171, 1177, 1178, 1189, 1190, 1192, 1193, 1197, 1199, 1206, 1210, 1211, 1213, 1216, 1222, 1225, 1229
Arthrobacter, 635
A. sp., 701, 711
Arthropoda (arthropods), 826
Aschelminthes (aschelminths), 1146, 1168
Ascidia (ascidians), 977, 1109
Ascomycetes, 692, 694

- Ascophora, 1171
Aselomaris, 1130
Aspergillus luchuensis, 694
Aspidisca angulata, 614, 615
Asplanchna, 690, 691, 1131, 1135
A. amphora, 1189
A. brightwelli, 1156
A. intermedia, 1216
A. sieboldi, 1156
Astarte sp., 1096
Astasia, 1136
Asterias, 951, 966, 1197
A. amurensis, 949, 962, 1163, 1169
A. forbesi, 931, 945, 946, 949, 960, 962, 1136, 1137, 1150, 1154, 1183, 1187
A. forreri, 1171
A. glacialis, 1219
A. grönlandica, 1181
A. rubens, 943, 945, 947, 949, 950, 952, 960, 961, 963, 966, 1136, 1137, 1154
A. sp., 977
A. vulgaris, 931, 946, 949, 1225, 1228
 asterids, 1155
 Asteroiidae, 1212
Asterina exigua, 960
A. gibbosa, 949, 956, 960
A. pectinifera, 949
A. regularis, 949
Asterinopsis aucklandensis, 949
Asterionella japonica, 768, 790, 792, 794, 797, 801, 807
 Asteroidea (asteroids), 937-939, 941-952, 954-956, 958, 960, 964, 966, 967, 1124, 1132, 1139, 1150, 1151, 1181, 1185, 1189, 1197, 1201, 1211, 1212, 1222, 1228
Astroclamys bruneus, 959
Astrometis sertulifera, 949
Astropecten, 1137
A. acanthifer, 949
A. aranciacus, 945, 1136
A. armatus, 949
A. articularis, 949, 951, 1223
A. auranciacus, 949
A. bispinosus, 949
A. cingulatus, 949, 1137
A. formosus, 949
A. granulatus, 949
A. irregularis, 949, 1175
A. javanicus, 949
A. polyacanthus, 945, 1190
Astropyga radiata, 953
Athecata, 651, 1126, 1134, 1175
Atheresthes stomias, 1010
Atrina japonica, 936
 Atyidae, 1210
Aulorhynchus flavidus, 979
Aurelia aurita, 642, 643, 647, 1129, 1145, 1213
Austrocidaris canaliculata, 959
 Autolytinae, 1161
Autolytus brachycephalus, 734
A. pictus, 734
A. prolifer, 722, 723, 1163
Axinella foveolaria, 637
A. polypoides, 637
 ayu, 1022, 1028, 1166, 1210
 Bacillariophyceae, 593, 594, 910
 bacillus, 615
Bacillus megatherium, 695
B. polymyxa, 999
B. subtilis, 595
 bacteria, 580, 581, 583, 585, 586, 588, 591, 592, 595, 596, 599-603, 606, 611-613, 615, 616, 620, 624-626, 628-630, 635, 659, 662-664, 666, 667, 670, 672, 678, 685, 686, 688, 689, 692-696, 698, 700-704, 706, 708-712, 715, 718, 719, 731, 734, 739, 740, 746, 753, 756, 763, 766, 769, 776, 777, 781, 788, 795, 800, 804, 807, 808, 848, 857, 864, 870, 882, 883, 889, 894, 897, 908, 911, 913-918, 921, 940, 942, 945, 953, 954, 975, 997, 999-1003, 1008, 1062, 1069, 1072, 1079, 1080, 1083, 1085, 1121, 1135, 1137, 1145, 1164, 1191, 1192, 1195, 1199, 1202, 1210, 1211, 1213, 1222
Bairdiella chrysur, 979, 1005, 1124
B. icistia, 1023
Balaenoptera acutorostrata, 1035
B. musculus, 809
B. physalus, 828, 1179
Balanus, 662, 802, 803, 1142
B. algicola, 799
B. amphitrite, 802, 803
B. amphitrite albicostatus, 977, 1169
B. amphitrite amphitrite, 1173
B. amphitrite communis, 801, 806, 1173
B. amphitrite denticulata, 799, 803, 1142
B. amphitrite hawaiiensis, 803, 1167
B. amphitrite niveus, 803, 1142
B. amphitrite variegatus, 803
B. balanoides, 799-802, 804, 805, 807, 952, 977, 983, 1128, 1129, 1143, 1166, 1176, 1221
B. balanus, 802, 804, 1128
B. crenatus, 802-804, 1128, 1165
B. eburneus, 799, 803
B. glandula, 977
B. hameri, 800, 1221
B. improvisus, 803, 1141, 1142
B. maxillaris, 799
B. perforatus, 799, 802-804
B. porcatus, 1143

- B. tintinnabulum*, 806
B. tintinnabulum tintinnabulum, 803
B. trigonus, 799, 803, 806, 1127
B. variegatus, 804, 1173
Barbus gonionotus, 845
barnacles, 799–801, 803, 805–807, 884, 934, 945, 949–951, 1020, 1127–1129, 1141, 1144, 1152, 1165, 1166, 1173, 1191, 1196, 1200, 1206, 1218, 1221, 1227
barnacle, acorn, 1152
barnacle, gooseneck, 806
barracouta, 1094
bass, 1128
bass, white, 1084
Bathylaster loripes obesus, 949
Bathycrinus, 947
Bathyploetes natans, 957
Batillaria minima, 896
bdelloids, 685, 686, 1161
Belone belone, 969, 980, 994, 995, 1032, 1205
beluga, 1038, 1042, 1044, 1047, 1058, 1072, 1090, 1109, 1155, 1179
Berardius bairdi, 1109
Beroë ovata, 648
Biddulphia, 1141
B. mobiliensis, 976
B. sinensis, 774
birds, 580, 583, 1021, 1041, 1094, 1208
Bittium sp., 877
Bivalvia (bivalves), 641, 648, 654, 724, 726, 853, 871, 873, 884–886, 895, 897, 898, 900–936, 949, 951, 952, 979, 1028, 1076, 1085, 1093, 1095, 1136, 1138, 1149, 1150, 1153, 1168, 1183, 1192, 1193, 1206, 1222, 1225, 1227, 1228
Blenniidae, 1151
Blennius pavo, 1151
bluefish, 1145
blue runner, 1089, 1110
Bolina sp., 647
Boloceroides, 1182
B. sp., 665
bonita (bonito), 788, 1088, 1107, 1111
bonita, Pacific, 1096, 1097
Botrylloides sp., 662
Bougainvillia, 654, 1130
B. carolinensis, 651
B. muscus, 650, 651
B. ramosa, 650
B. sp., 651, 654, 655, 1218
B. superciliaris, 658, 1192, 1224
boute, 1035
Bowerbankia caudata, 718
B. gracilis, 713, 718
B. imbricata, 713, 718
box jellies—see Cubozoa
Brachidontes senhousia, 927
Brachiomonas submarina, 593, 594, 725, 892
B. submarina var. *pulsifera*, 593, 892
Brachionus, 690, 691, 978, 1154
B. angularis, 684, 689
B. bakeri, 684, 1184
B. calyciflorus, 688, 689, 1149, 1156, 1160
B. calyciflorus var. *pala*, 687
B. pala, 684, 1190
B. plicatilis, 679–684, 688, 689, 691, 809, 822, 879, 977, 979, 980, 982–984, 996, 1007, 1153, 1166, 1170, 1190, 1217
B. rubens (*Monostyla quadridentata*), 686–689, 979, 1178, 1220
B. urceolaris, 684, 1205
B. urceolaris sericus, 686, 687
B. variabilis, 686
Brachipoda, 1168
Brachiopoda (brachiopods), 949, 1214
Brachydanio rerio, 1178
Brachyura (brachyurans), 813, 874, 1142, 1162, 1179, 1206, 1215
Branchinecta, 743
Brachiopoda (brachiopods), 580, 742–761
Branchipus, 743
Brania (*Grubea*) *clavata*, 723
bream, black sea, 1165
bream, gilthead, 1013, 1206
bream, red sea, 1005, 1012, 1017, 1195, 1228
bream, sea, 979, 987, 1195
Brisingella coronata, 949
Brissopsis lyrifera, 953
brittle-stars, 937, 939, 950, 956, 966, 1189, 1214
Bryozoa (bryozoans), 583, 697, 709–720, 950, 954, 1127, 1136, 1152, 1162, 1170, 1171, 1188, 1206, 1208
Buccinum, 726
B. undatum, 727, 1150
buffalo fish, 1084
Bugula, 713, 716, 1127, 1208
B. avicularia, 716, 1172, 1208
B. flabellata, 716, 1157
B. neritina, 718, 1184
B. sp., 718
B. stolonifera, 718
B. turrita, 716, 1157
Bulimina, 596
Bulla gouldiana, 977, 978
Bursosaphia baltalimaniaformis, 688, 669, 677, 678
butterfish, 1089, 1101, 1110
Caenorhabditis briggsae, 1193, 1194
Calanipedia aquae-dulcis, 1154
Calanoida (calanoids), 766, 768, 785, 1141, 1158, 1164, 1173, 1207, 1229

- Calanus*, 769–775, 820, 1162, 1191
C. cristatus, 769, 785, 792, 1195
C. finmarchicus, 769–771, 779, 791, 954, 1124, 1132, 1153, 1179, 1186, 1201
C. helgolandicus, 768–774, 785, 791, 792, 796, 1141, 1192, 1196, 1203
C. hyperboreus, 769, 774, 792, 954, 1140
 Calcareae, 637
Callinectes sapidus, 689, 728, 760, 822, 874, 1215
Callorhinus ursinus, 1039, 1055, 1074, 1076, 1082, 1094, 1103, 1116, 1119, 1120, 1129
Calpasoma dactyloptera, 1187
Calvasterias laevigata, 949
C. suteri, 949
 Calyptoblastea, 1224
Campanularia, 1130, 1138, 1143, 1168, 1189, 1227
C. calceolifera, 651
C. flexuosa, 651, 655, 1214, 1223, 1227
C. johnstoni, 722
 Campanularidae (campanulids), 665, 1130, 1224
Cancer irroratus, 874, 875, 880
C. pagurus, 821, 953
 capelin, 1094, 1095, 1097, 1100, 1109
Capitella, 723, 1175
C. capitata, 723, 736, 742, 765, 1127, 1130, 1202
C. sp., 723
Capulus ungaricus, 1228
 carangids, 1001, 1215
Caranx crysos, 1110
C. mate, 999–1003, 1215
Carassius auratus, 1004
Carcinus maenas, 647, 728, 808, 821, 833, 875, 953, 978, 1146, 1212, 1226
Cardium, 726
C. edule, 728, 934, 1174
C. glaucum, 1174
C. groenlandicum, 1096
 Caridea (carideans), 665, 813, 1164, 1166, 1176, 1193, 1206, 1210
 Caridina, 1210
 Carnivora, 1035
 carp, 664, 1008, 1017, 1018, 1023, 1028, 1029, 1084–1086, 1126, 1128, 1157, 1195, 1200
 carp, big head, 845
 carp, grass, 845
 carp, silver, 845
 carrion, 1097
Carteria chuii, 936
C. sp., 669, 670, 910
Carybdea rostoni, 648, 1195
 Carybdeidae, 1124
Caspiolosa sp., 1096
 catfish, 808, 875, 1008, 1009, 1013, 1017, 1019, 1084, 1088, 1125, 1215
 catfish, Channel, 1018, 1019, 1147
 catla, 845
Calla buchanani, 1109
C. catla, 845
Caulerpa prolifera, 945
 Centricae, 673
Centropages furcatus, 785
C. hamatus, 786, 983
C. kroyeri, 785
C. typicus, 768, 785, 792, 796, 1154
 Cephalocarida, 743
 Cephalopoda (cephalopods), 884, 1094, 1095, 1097, 1098
Cephalorhynchus commersoni, 1109
Cephalosporium sp., 1000
Cephea cephea, 643, 1215
Ceramium, 597
Ceratostoma burnetti, 931
Cerianthus lloydii, 661
Ceratium, 981
 Cetacea (cetaceans), 1038, 1044, 1048, 1059, 1111, 1121, 1126, 1135, 1136, 1147, 1156, 1169, 1173, 1198, 1209, 1211, 1212, 1216, 1218, 1221, 1229
Cetengraulis mysticetus, 1176
Chaetoceros, 853, 978
C. calcitrans, 892, 910, 915, 922
C. ceratosporum, 817
C. curvisetus, 774, 791
C. danicus, 778, 780, 781, 793
C. rigidus, 820
C. simplex, 820, 1172
C. sp., 769, 790, 793, 976
 Chaetognatha (chaetognaths), 653, 665, 815, 816, 818, 873, 975, 1168
Chaetomorpha, 978, 1006
Chaetopterus, 1185
C. variopedatus, 733, 740–742, 1149, 1223
Chalina oculata, 637
Chalinula fertilis, 630
C. montagui, 630
Chanos chanos, 845, 856, 978, 1006, 1165, 1208, 1216, 1221
 Cheilostomata, 1171
Childia, 1133
C. groenlandica, 669
Chilomonas paramecium, 616, 1187
C. sp., 943
Chiridota rotifera, 957, 1139
Chirocephalus, 743
 chironomids, 726, 845, 980
 chitons, 884, 949
Chlamydomonas, 596, 619, 669, 688, 732, 818, 911

- C. coccooides*, 922
C. moewusi, 618
C. parkeae, 892
C. pulsatilla, 593
C. reinhardii, 769, 790, 793
C. sp., 732, 760, 771, 791, 794, 799, 803, 807, 910, 911, 976
C. sphagnicolo, 754
C. spreta, 593
C. subehrengerii, 695
Chlamys farreri nipponensis, 900
Chlorella, 679, 682, 683, 685, 686, 688, 689, 815, 884, 912, 1169
C. autotrophica, 922
C. ellipsoidea, 593, 594
C. marina, 909
C. pyrenoidosa, 684, 686
C. sp., 682, 683, 686, 722, 731, 753, 764, 787-789, 803, 817, 847, 879, 906, 909-913, 916, 976, 978, 979
C. stigmata, 976
C. stigmatophora, 770, 771, 801, 909, 922
C. vulgaris, 943
Chlorococcales, 593, 594, 726
Chlorococcum sp., 599, 695, 910, 915
Chlorodendron subsalsum, 731
Chlorohydra viridissima, 1205
Chlorophyceae (chlorophytes), 694, 695, 710, 726, 909, 1007
Choanoflagellida (choanoflagellates), 585-587, 612, 1157
Chondrosia reniformis, 637
Chone teres, 977
Chordaria flagelliformis, 728
Choromytilus choros, 901
Chromadora axi, 696, 708, 1217
C. macrolaimoides, 692-696, 698, 704, 710, 1217
C. quadrillinea, 708
C. sp., 708
chromadorids, 696
Chromadorina epidemos, 704
Chromadorita tenuis, 705, 710
Chromulina pleiades, 909-911, 915
C. pusilla, 976
Chroococcus, 1006
Chroömonas, 763, 788
Chrysocra hysocella, 648
C. isosceles, 1145
C. quinquecirrha, 643, 644, 1140
Chrysochromulina, 909
C. brevifilum, 801, 807
C. ericina, 801, 807
chrysonomads, 619
Chrysophrys aurata, 1013, 1014, 1206
C. major, 1005, 1012, 1013, 1017
Chrysophyceae (chrysophytes), 593, 594, 909, 1203
Chthamalus, 801
C. dentatus, 799
C. stellatus, 799-804, 1128, 1129
chub, 1084, 1085
Cibicides lobatulus, 1194
cidarids, 1190
cidaroids, 1166
Ciliata (ciliates), 601-618, 620, 621, 623, 624, 668, 669, 678, 696, 697, 700, 701, 706, 711, 712, 723, 731, 769, 781, 897, 934, 1145, 1150, 1157, 1160, 1166, 1172-1174, 1179-1181, 1183, 1189, 1195, 1196, 1212, 1219, 1221, 1225
Cirratulus cirratus, 736, 1155
Cirriformia tentaculata, 736, 1155
Cirripedia (cirripedes), 728, 742, 798-807, 815, 979, 1128, 1143, 1159, 1181, 1191, 1200, 1218, 1221
Cladocera (cladocerans), 726, 743, 977, 1006, 1211
Cladonema radiatum, 651
Cladophora, 1006, 1007
C. rupestris, 728
Cladosporium herbarium, 694
clams, 582, 821, 853, 871, 900, 910, 933, 936, 937, 945, 949-951, 1084, 1097, 1101, 1107, 1136, 1144, 1162, 1183, 1212
clam, bloody, 1169
clam, butter, 1133
clam, coot, 1136
clam, giant, 935
clam, hard, 1136, 1137
clam, hard shell, 1165, 1215
clam, short-necked, 664, 818, 824, 827, 853, 854, 882
Clathria coralloides, 637, 638
Clausocalanus acucornis, 785
Clava multicornis, 651, 655, 656, 1175, 1196
C. squamata, 651, 1151
Clavelinicea lepadiformis, 742
Clavidae, 1175
Clibanarius zebra, 581
Clinocardium nuttalli, 1096
Cliona, 1222
C. celata, 632, 637, 1222
C. stationis, 630
Clione limacina, 886, 897, 900, 1140, 1176, 1178
C. sp., 642
C. stationes, 1193
Clostridium perfringens, 1053
Clupea harengus, 808, 953, 969, 970, 974, 979, 982, 983, 987, 991, 992, 994, 995, 997, 998, 1017, 1029, 1030, 1032, 1086, 1132, 1134, 1155, 1176, 1204, 1205, 1207, 1224, 1226

- C. harengus pallasi*(i), 1028, 1193
C. pallasi, 972, 1010, 1170, 1214
C. sp., 1096
C. sprattus, 1089, 1120
 Clupeidae, 1100
 clupeiformes, 1085
 clupeoids, 981, 982, 992
Clupeonella sp., 1096
Clytia attenuata, 651, 666, 1224
C. johnstoni, 650, 651, 1160, 1167
 Cnidaria (cnidarians), 583, 602, 641-668, 760,
 935, 953, 1033, 1134, 1175, 1206, 1224
 coalfish, 1221
 coccolithophores, 629
 coccolithophorids, 785
Coccolithus hualeyi, 778, 779
Coccomyxa sp., 909
Cocconeis, 978
 cockles, 871
 cod, 826, 832, 971, 980, 991, 1083, 1084, 1089,
 1094, 1095, 1097-1099, 1109, 1110, 1125,
 1215, 1221
 cod, Arctic, 1097
 cod, Atlantic, 1100, 1191
 cod, black, 1095
 cod, ling, 1111
 cod, Pacific, 1152
 codfish, 1099, 1100
Coelastrum sp., 688
 Coelenterata (coelenterates), 641, 1138-1140,
 1144, 1145, 1180, 1182, 1186, 1197, 1201,
 1202, 1218, 1228
 Coelomate, 1168
Colpidium, 617, 620, 1204, 1214
C. campylum, 617, 1214
C. colpoda, 1144
Colpoda, 616
 Columbelloidea, 1207
Colurella colurus, 684, 689
Comactinia echinoptera, 948
Comanthus japonica, 955, 1144
 comasterids, 947
 comatulids, 947, 948
 conch, queen, 582
Condyllostoma patulum, 614, 615
C. sp., 602, 624
Conopeum reticulum, 718
C. seurati, 718
Conus striatus, 935
Convoluta, 669-671
Convoluta convoluta (syn.: *C. paradoxa*), 671,
 674, 676, 677, 1186
C. roscoffensis, 669, 670, 678, 1177, 1199
 Convolutidea, 668
 Copepoda (copepods), 580, 624, 641, 645, 648,
 650, 653, 654, 656, 662, 668, 723, 726, 728,
 742, 761-798, 808, 810, 815, 818, 820, 847,
 879, 881, 947, 954, 974, 975, 977-979, 981,
 982, 996, 1006, 1007, 1020, 1033, 1034, 1126,
 1128-1130, 1132, 1133, 1138, 1140, 1141,
 1148, 1154-1156, 1158, 1161, 1164, 1167,
 1169-1171, 1173, 1175, 1176, 1179, 1181,
 1182, 1184-1186, 1191-1193, 1195, 1196,
 1207, 1216, 1221, 1229
 corals, 600, 606, 627-629, 645, 661-664, 666,
 798, 948, 949, 952-954, 1124, 1127, 1132,
 1133, 1138, 1140, 1145, 1148, 1156, 1157,
 1171, 1173, 1184, 1186, 1194, 1197, 1213,
 1214, 1221, 1228
Corbicula japonica, 927
Cordylophora, 657, 1153, 1181
C. caspia (syn.: *C. lacustris*), 651, 656, 657,
 665, 666, 726, 727, 1126, 1157, 1175,
 1204
Coregonus albula, 1096
C. peled, 1218
 cormophytes, 726
 Cornacuspongida, 637
 Coronatae, 1224
Corymorpha palma, 1137
Coryne, 1130
C. tubulosa, 651
 coryneforms, 857
Coscinasterias, 951
C. calamaria, 949
Coscinodiscus, 978
C. angstii, 810
C. asterompharus, 770, 792
C. centralis, 770, 771
C. concinnus, 976
C. lineatus, 770, 792
C. radiatus, 976
C. sp., 981
C. wailesii, 783, 794
Cosmarium, 978
 crabs, 664, 727, 760, 812, 841, 815, 821, 839,
 859, 873-879, 882, 883, 949, 951, 978, 979,
 1010, 1095, 1097, 1099, 1109, 1111, 1152,
 1165, 1179, 1201, 1206, 1215, 1217
 crab, blue, 689, 1215
 crab, common, 1095
 crab, Dungeness, 1084
 crab, fiddler, 1220
 crab, hermit, 581, 660, 726, 1097, 1134, 1163,
 1201
 crab, king, 879, 1084, 1207
 crab, mud, 1139, 1140, 1142, 1149
 crab, sand, 876, 1201
 crab, shore, 854, 978, 1165
 crab, spider, 1096
 crab, stone, 839, 876
Crangon, 841, 842

- C. crangon*, 707, 708, 808, 833, 841, 842, 871, 1134, 1144, 1155, 1187, 1194, 1217
C. septemspinosa, 842, 1202
C. vulgaris, 1148, 1188, 1189, 1198, 1226
Craspedacusta, 1184, 1202
C. sowerbyi, 652, 658, 1184, 1187
Crassostrea, 908, 934, 1222
C. angulata, 902, 919, 933
C. commercialis, 902, 933
C. edulis, 920
C. eradelie, 902, 1200
C. gigas, 901, 902, 915, 919, 921, 927, 930, 931, 933, 936, 977, 1127, 1133, 1134, 1187, 1188, 1196, 1222
C. rhizophorae, 902, 933
C. virginica, 632, 821, 822, 825, 901–904, 906, 910, 912, 914, 916, 917, 919, 921, 924, 925, 928, 932–934, 936, 912, 1135–1137, 1143, 1144, 1147, 1154, 1165, 1182, 1184, 1192, 1203, 1214, 1220, 1225
crawfish, 1084
crayfish, 812, 1126, 1182
Crepidula, 897, 898, 935, 1140, 1195
C. adunca, 897
C. formicata, 726, 728, 742, 887, 892–894, 897, 898, 1138, 1186, 1223
C. plana, 897, 1157
C. sp., 977
C. williamsi, 897, 1140
Cribrilina punctata, 718
Cricosphaera carterae, 717–719, 892, 894, 922
C. elongata, 593, 595
Crinoidea (crinoids), 937, 939, 943, 944, 947, 948, 955–957, 966, 967, 1139, 1150, 1171, 1186, 1188, 1190
Crisia, 713
C. sp., 718
Cristigera, 616, 620
C. sp., 616
Crithidia fasciculata, 618
Croomonas salina, 936
Crossaster papposus, 950, 951
Crustacea (crustaceans), 580, 582, 583, 623, 641, 642, 648, 655, 661, 671, 678, 728, 737, 739, 742–884, 932, 947–954, 981, 1006, 1033, 1085, 1093, 1094, 1096, 1097, 1099, 1108–1110, 1128, 1134, 1140, 1141, 1154, 1156–1161, 1164, 1166, 1169, 1172, 1176, 1178, 1187, 1188, 1195, 1198, 1202, 1203, 1206–1208, 1210, 1213, 1221, 1222, 1226
Cryptasterias, 958
Crypthecodinium cohnii (syn.: *Gyrodinium cohnii*), 588–590, 620, 622, 1174, 1218
Cryptochrysis rubens, 909
Cryptomonas, 717
C. acuta, 909
C. maculata, 976
C. ovata, 618
C. sp., 602, 624, 625, 716, 718, 719, 801, 910, 922, 942
Cryptophyceae, 593, 909
Cryptosula pallasiana, 718, 1171
Crystophora cristata, 1056
Ctenocalanus vanus, 785
Ctenocidaris geliberti, 959
C. nutrix, 959
C. perrieri, 959
C. spinosa, 959
Ctenodiscus australis, 958
C. crispatus, 950
Ctenopharyngodon idella, 845
ctenophorans, 648
ctenophores, 644, 815, 816, 873, 975, 1222
Cubomedusae, 648, 1140, 1224
Cubozoa, 641, 648, 649, 1224
Cucumaria coatsi, 957
C. crocea, 957
C. curata, 957, 1212
C. elongata, 948, 1150
C. glacialis, 957, 1190
C. ijimai, 957
C. joubini, 957
C. laevigata, 957
C. lamperti, 957
C. lateralis, 957
C. parva, 957
C. planci, 957
C. pseudocurata, 957, 1205
C. pseudopopulifera, 948
C. saxicola, 941
C. vaneyi, 957, 1138
Culcita schmideliana, 950
Culcitania achrasporea, 694
cumaceans, 726
cunner, 1005, 1138
cushion-stars, 1189, 1204
cuttlefish, 1089, 1097, 1098
Cyanea capillata, 647, 1197
C. lamarki(i), 648, 1145
Cyanophyceae (cyanophyceans), 726, 909, 1007
Cyclidium, 616
Cyclopoidea (cyclopoids), 785
Cyclops sp., 980
Cyclotella, 821
C. cryptica, 763, 788
C. nana, 763, 776, 783, 788, 791–794, 894, 910, 915, 1159
C. sp., 596, 910
Cylindrotheca closterium, 599, 600, 695, 710
C. fusiformis, 673, 695
Cynoscion nebulosus, 1005, 1124

- C. regalis*, 1092
Cyphastrea ocellina, 664
 Cyphonantes, 709, 1178
 cypriniformes, 1085
 cyprinodonts, 683, 1175
Cyprinus carpio, 664, 981, 1030, 1031
Cystophora cristata, 1092, 1097, 1103, 1116, 1148, 1189
Cytophaga, 999

 dab, 1031, 1203
Dactylometra quinquecirrha, 648, 1182
 dangit, 1186
Danio malabaricus, 708
Daphnia, 743, 1210, 1213
D. magna, 656, 756
D. pulex, 977
D. sp., 977, 980
 Daphnidae (daphnids), 743, 980
 dead men's fingers, 662
 Decapoda (decapods), 808, 812–884, 979, 1139, 1140, 1146, 1147, 1150, 1152, 1159, 1160, 1163, 1164, 1166, 1167, 1169, 1175, 1176, 1186, 1187, 1195, 1197–1199, 1202, 1203, 1206, 1211, 1226
Delesseria sanguinea, 728
D. sp., 735
Delphinapterus leucas, 1038, 1039, 1041, 1042, 1044, 1045, 1047, 1053, 1058, 1072, 1075, 1077, 1088, 1090, 1091, 1108, 1109, 1112, 1129, 1155, 1179
 Delphinidae (delphinids), 1038, 1042, 1052, 1058, 1061, 1071, 1078, 1109, 1198
 Delphinoidea, 1091
Delphinus, 1162
D. delphis, 1040, 1041, 1043, 1050, 1109, 1121, 1212
 Demospongiae, 629, 631, 638, 1130, 1202
Dendroaster eccentricus, 977
Dendryphiella arenaria, 692, 694, 697, 710, 711
D. sp., 694
Dentalium, 950
Denticula seminae, 770, 792
Deontostoma californicum, 703, 706, 1221
Dermasterias imbricata, 950, 1222
Desmodora scaldensis, 704, 706, 707, 710
Desmonales sp., 596
Detonula confervacea, 1159
 Deuteromycetes, 692, 694
Diadema, 1152
D. setosum, 945, 953, 955, 1228
Diapoliculina rotunda, 602, 603, 624
Diaphanoeca grandis, 585–587, 612, 622
Diaschiza, 690
 diatoms, 582, 596, 600, 601, 615, 629, 632, 668, 671–673, 678, 694, 696, 697, 700, 703, 706, 710–713, 719, 724, 726–728, 733, 734, 739, 768, 770, 772, 774, 777, 779, 783, 785, 787, 791, 799–801, 806, 808, 809, 817, 818, 820, 821, 847, 853, 888, 892, 893, 895, 897, 910, 918, 934, 936, 942, 944, 947, 948, 950, 951, 953, 976–979, 1006, 1007, 1135, 1159, 1166, 1172, 1190, 1203
Dicentrarchus labrax, 1128, 1156
Dicrateria gilva, 909, 915
D. inornata, 771, 909, 910, 915, 922
D. sp., 777, 778, 793, 910
Diglena, 690
D. volvocola, 1229
 dinoflagellates, 587, 588, 590, 591, 605, 619, 625, 629, 689, 700, 701, 711, 716, 723, 731, 772, 774, 777, 785, 821, 897, 934, 947, 975, 978, 982, 983, 1128, 1148, 1174, 1218
Dinophilus, 734, 1129, 1140, 1192
D. apatris, 1176, 1186, 1210, 1219
D. gyrociliatus, 734, 736, 742, 1209, 1218
Diogenes pugilator, 1220
Diophrys scutum, 614, 615
Diplanthera wrightii, 945
Diplasterias, 958
D. brandti (= *Lütkeni*), 958
D. brucei, 958
D. meridionalis, 958
D. octoradiata, 958
Diplolaimella ocellata (syn.: *D. schneideri*), 696, 697, 705, 710
Diplolaimelloides islandica, 705, 710
D. oschei, 705, 710
D. sp., 704, 711
Diploneis, 1006
 dipterans, 726
Dipurena halterata, 651, 1201
D. reesi, 651, 658, 1159
Discorbis, 596
Discorinopsis aguayoi, 1126
D. vadescens, 1126
Ditylum, 815, 884
D. brightwellii, 768, 770, 771, 783–785, 790–792, 794, 801, 807, 875, 976, 1203
 dogfish, 1010, 1097
 dolphins, 1035, 1039–1041, 1045, 1047–1052, 1054, 1059, 1060, 1062, 1065, 1067–1072, 1075, 1078–1081, 1086, 1093, 1110, 1112, 1115, 1125, 1127, 1136, 1147, 1148, 1150, 1155, 1156, 1173, 1181, 1186, 1189, 1192, 1194, 1195, 1197, 1198, 1201, 1212, 1226
 dolphin, Amazon, 1058, 1109, 1111, 1143
 dolphin, blue-white, 1109
 dolphin, bottle-nosed, 1040, 1047, 1052, 1058, 1072, 1109, 1124, 1171, 1184, 1216, 1225
 dolphin, Commerson's, 1109
 dolphin, common, 1040, 1109

- dolphin, Irrawaddy, 1110
dolphin, Ganges, 1058, 1109
dolphin, Gill's bottle-nosed, 1058, 1109
dolphin, Indus, 1092, 1109, 1156
dolphin, Northern right-whale, 1040, 1053, 1109
dolphin, Pacific white-sided, 1040, 1058, 1109
dolphin, Risso's, 1058, 1110
dolphin, spotted, 1058
dolphin, white-beaked, 1109
dolphin, white-sided, 1054
Dorvillea articulata, 736, 742
drill, 931, 933
drill, oyster, 1185
Drosophila, 737
D. melanogaster, 1214
ducks, 1069
dudong, 1050
Dugesia tigrina, 1174
Dunaliella, 596, 682, 688, 689, 766, 815, 821, 884, 923
D. euchlora, 631, 906, 910, 913, 922
D. marina, 725
D. parva, 599, 604, 625, 695
D. primolecta, 593, 602, 604, 624, 625, 789, 801, 809, 810, 875, 892, 976
D. quartolecta, 695
D. salina, 599, 602, 604, 624, 625, 695, 724, 746, 976
D. sp., 590, 596, 602, 615, 624, 625, 669, 679-681, 716, 733, 747, 752, 768, 775, 787, 789, 790, 792-795, 809, 821, 826, 887, 910, 922, 923, 942, 954, 976
D. suecica, 604, 625
D. tertiolecta, 602, 604, 606, 624, 625, 717-719, 724, 789, 838, 894, 909, 912, 922, 942
D. viridis, 604, 625, 746, 754
Dytaster spinosus, 950
- earthworms, 737, 738, 821, 845, 1165
Ebalia, 1179
Echeilota clausa (= *E. hartlaubii*), 1205
Echinaster, 952, 1150
E. echinophorus, 946
echinasterids, 946
Echinocardium, 953, 1197
E. cardium, 947, 1197
E. flavescens, 953
E. sp., 950
Echinodermata (echinoderms), 580, 583, 640, 715, 808, 815, 884, 898, 935-967, 979, 1096, 1125, 1127, 1129, 1132, 1138-1140, 1145, 1146, 1148-1150, 1156, 1157, 1166, 1168, 1176, 1184, 1188, 1190, 1191, 1193, 1197, 1199, 1205, 1207, 1212, 1213, 1215, 1217, 1219, 1221, 1228
- Echinoecus pentagonus*, 1137
Echinoidea (echinoids), 937-943, 945-947, 949, 950, 952-956, 959, 963-967, 1137, 1143, 1150, 1152, 1156, 1157, 1176, 1185, 1190, 1191, 1197, 1199, 1211
Echinometra lacunier, 950
E. mathaei, 941, 942, 953, 954
Echinometridae, 1143
Echinoneus cyclostomus, 953, 954
Echinothrix calamaris, 945, 953, 954
Echinus, 874
E. acutus, 941
E. esculentus, 941, 943, 953, 965, 1190
E. miliaris, 941
Ecklonina cava, 952
Ectoprocta, 709, 1168, 1214
eels, 689, 1004, 1005, 1010, 1012, 1017, 1018, 1027, 1028, 1089, 1125, 1126, 1136, 1148, 1160, 1162, 1188, 1194, 1209, 1217, 1219, 1228
eel, American, 1148, 1229
eel, conger, 1097, 1098
eel, moray, 1084, 1098
eel, sand, 1010, 1098
Egregia laevigata, 698, 703, 706
Eirene viridula, 651, 658, 665, 1131, 1159, 1173
Eisenia foetida, 738, 742
elasipods, 948
Electra, 713
E. crustulenta, 718
E. monostachys, 718
E. pilosa, 709, 714, 715, 718
E. posidoniae, 718
Eleutheria dichotoma, 651
Eleutheridae, 1134
Elminius, 949
E. modestus, 799-801, 803-807, 1141, 1143, 1221, 1227
Elops machnata, 1165
Elphidium crispum, 596
Emerita talpoida, 876, 1201
Enchelys, 616
enchytraeids, 644, 726-728, 1146
Enchytraeus, 735, 737, 1183
E. albidus, 641, 656, 661, 726, 735, 737, 739, 740, 742, 808, 821, 878, 1132, 1172, 1208
E. fragmentosus, 735
E. sp., 980
Encope aberrans, 945
Endoxocrinus, 947
Engraulidae, 1100
Engraulis mordax, 689, 973, 975, 980, 982-984, 987, 992-997, 1022, 1034, 1168, 1177, 1179, 1180, 1194
E. sp., 1100
Enhydra lutris, 1035

- Enoplus communis*, 691, 1225
E. paralittoralis, 704, 711
Ensis directus, 901, 926
Enteromorpha, 597, 729, 730, 766, 978, 1006, 1007
E. intestinalis, 598, 692, 702, 878, 1007
E. linza, 728, 808, 925
E. prolifera, 788
E. sp., 726–728, 736, 789, 977–979, 1007
Entoprocta, 709, 1168
Eopsetta grigorjewi, 1153
Ephydatia fluviatilis, 629, 1174
Ephyrina ombango, 879
Epiphanes, 690, 691
E. (Hydatina) senta, 686
Erignathus barbatus, 1056, 1074, 1097, 1116, 1185
Erylus mammillaris, 630
Escharella immersa, 718
Escherichia coli, 595, 629, 685, 686, 695, 701, 712, 1115
Eschrichtius robustus, 1035
Eteone longa, 728
Eubacteriales, 999
Eucalanus elongatus, 785
Eucampi sp., 856
Euchaeta japonica, 775, 792, 1180
E. norvegica, 954
Eucheilota maculata, 651–653, 658, 1224
Eucheuma nudum, 945
Euchromadora gaulica, 704
Eudendrium, 1130
E. armatum, 651, 660, 667, 1222
Eudorina, 688
Eudypetes sp., 1095
Eufolliculina sp., 602, 603
euglenae, 688
Euglena gracilis, 686–688
E. sp., 685
euglenids, 618
euglenoids, 700, 856
eulachon, 1099
Eumetopias jubatus, 1055, 1074, 1076, 1090, 1095, 1104, 1106, 1198
E. stelleri, 1193
Eunice viridis, 723, 724, 1163
Eunicidae, 1198
eupagurids, 661
Eupagurus bernhardus, 726, 727, 1134, 1156
E. karnivor, 726
Euphausia brevis, 810
E. eximia, 810, 811
E. gibboides, 810
E. hemigibba, 810
E. krohnii, 810
E. pacifica, 809–812, 1176, 1178, 1197
E. recurva, 810
E. superba, 1101, 1152
Euphausiacea (euphausiids), 808–812, 859, 881, 975, 1093, 1094, 1098, 1099, 1109, 1157, 1171, 1176, 1178, 1179, 1198, 1217
Eupleura, 935
E. caudata, 931, 1185
Euplotes, 603, 604, 616, 1183, 1201
E. antarcticus, 603, 604, 624
E. balteatus, 603, 604, 624
E. cristatus, 603, 1225
E. sp., 603, 624, 976
E. vannus, 603, 604, 615, 624, 769, 790, 791, 1197
Eurypanopeus depressus, 880, 881, 1140
Eurytemora, 775–777, 820
E. affinis, 775–777, 782, 793, 1164, 1173
E. americana, 777, 1158, 1173
E. elongatus, 776
E. herdmani, 776, 777, 782, 793, 1158, 1173
E. hirundooides, 785
Euspongia irregularis var. *mollior*, 630
E. officinalis, 637
E. officinalis adriatica, 638
E. officinalis lamella, 638
E. officinalis mollissima, 638
Euterpina acutifrons, 767, 777–782, 785, 793, 1130, 1161, 1193
Eurhynchus alletteratus, 978
Eutima sapinhoa, 654, 1193
Eutonina sp., 647
Eutreptia marina, 717, 719
Evasterias, 951
E. troschelii, 950, 1139
Evechinus chloroticus, 954, 1145
Exuviaella, 689
E. baltica, 892
E. pusilla, 892
E. sp., 680, 785

Fabia subquadrata, 879, 1169
Fabrea salina, 604, 605, 621, 623, 625, 1145
Farella, 713
F. repens, 718
Favella campanula, 605, 625
feather-stars, 937, 947, 956
Ficulina ficus, 637
finfishes, 1124
fishes—see Pisces
flagellates, 585–591, 605, 611, 618–623, 625, 670, 671, 686, 696, 710, 711, 717, 718, 729, 730, 734, 739, 740, 770, 777, 785, 790, 800, 801, 806, 809, 821, 822, 824, 897, 906, 913, 942, 943, 1157, 1180, 1190, 1199
flatfishes, 973, 1095, 1097–1099, 1110, 1142, 1153, 1167, 1178

- flatworms, 1171
Flavobacterium marinum, 695, 696, 702, 712
F. sp., 701, 711
 flounder, 993, 1031, 1032, 1084, 1097–1099, 1109, 1189, 1203, 1224
 flounder, starry, 1095, 1195
Flustra, 713
F. foliacea, 714, 715
Flustrella hispida, 714, 1199
 folliculinids, 602, 603, 1219
 Foraminifera (foraminiferans), 596–601, 605, 621, 623, 700, 726, 947, 949–951, 953, 954, 1126, 1133, 1145, 1152, 1157, 1163, 1179, 1180, 1184, 1191, 1192, 1194, 1198, 1204, 1205
 Foricupulata, 1151
Fragilidium heterolobum, 976
Fragillaria sp., 599
 frogs, 961
Fromia ghardagana, 955
Fucus, 588, 735, 978
F. serratus, 714, 715
F. sp., 735
Fugu rubripes, 1010, 1019, 1020
F. vermicularis, 1010, 1019, 1020
Fulvia mutica, 936
Fundulus heteroclitus, 1189
 fungi, 581, 629, 692–694, 697, 700, 702, 704, 706, 709–712, 739, 756, 808, 843, 883, 975, 976, 1000, 1062, 1069, 1079, 1188
Fungia actiniformis var. *palawensis*, 1124
F. scutaria, 662, 664, 1197
Fusarium culmorum, 694
F. sp., 694
 Gadidae, 1100
 gadoids, 1082, 1083
Gadus callarias, 998
G. macrocephalus, 1152
G. morhua, 953, 1029, 1030, 1100, 1191, 1221
G. virens, 1221
Galaxea aspera, 1127
 gammarids, 728, 808
Gammarus duebeni, 1174
 garfish, 980, 1205
 garpike, 980, 994, 1032, 1224
Gasterosteus aculeatus, 1021, 1022, 1165, 1185
 Gastropoda (gastropods), 581, 658, 660, 726, 884–901, 927, 932, 934, 935, 949–951, 966, 979, 1028, 1140, 1150, 1195, 1196, 1207, 1223
 gastrotrichs, 685, 1146
 goatfish, 1098
Gemmosaccus sulcatus, 806, 1220
Genadas, 858
Geodia gigas, 637
 gilt-head, 1203
Gladiferens imparipes, 766, 1216
Glendinium foliaceum, 605, 625
Globicephala, 1043
G. macrorhyncha, 1040, 1041, 1053, 1075, 1091
G. melaena, 1052, 1053, 1058, 1075, 1076, 1110–1112, 1118, 1121
G. scammoni, 1038, 1049, 1075, 1091, 1093, 1110
 Globicephalidae, 1110
Globigerina, 950, 951
Gloeocapsa, 1006
 Glyceridae, 726–728
 gobies, 1110, 1145
 goldfish, 1019, 1029
Goniocidaris umbraculum, 959, 1190
Gonionemus vertens, 653
Gonothyrea, 650
Gonyaulax acatenella, 934
G. catenella, 934
 goose-barnacle, 799
 gourami, kissing, 845
 gourami, three-spot, 845
Gracilaria, 1006
G. confervoides, 1007
G. cylindrica, 1007
G. sjostedtii, 914
Grammatophora, 892
 Grampidae, 1058, 1110
Grampus griseus, 1043, 1058, 1069, 1076, 1110, 1111
Granaster, 958
G. nutrix, 958
Grantia compressa, 637
G. lieberkühni, 637
 Graspidae, 1162
 grass, eel, 596, 952
 grass, sea, 704, 954
 greenling, 1095
Grubea clavata, 1163
 grunions, 1144, 1187
 gurnets, 1094
Gymnodinium, 619, 689, 934
G. sp., 767, 771, 777–781, 790, 791, 793
G. splendens, 689, 772–774, 791, 856, 975, 976, 978, 980, 982–984
 Gymnosomata, 1178
Gyrodinium, 619
G. cohnii, 1157, 1199
Gyrosigma fasciola, 788
Habrotrocha constricta, 686
 haddock, 971, 983, 987, 1084, 1179
Haematococcus, 688

- hake, 1084, 1094–1098, 1100
Halecium halecinum, 650
halibut, 1031, 1084, 1095, 1097, 1109
Halicephalobus limuli, 706
Halichoanolaimus robustus, 704, 707
Halichoerus grypus, 1056, 1061, 1064, 1090, 1097, 1103, 1116, 1119, 1120, 1142, 1165, 1181, 1182
Halichondria panicea, 632, 637, 638
Haliotis, 1169, 1174
H. discus, 896, 898, 899, 927
H. discus hannai, 889, 897, 898, 900, 1173, 1174
H. diversicolor, 898
H. diversicolor supertexta, 889, 1194
H. gigantea, 889, 898, 900, 1192
H. rufescens, 889, 898, 1137
H. sieboldii, 898, 927
H. sorenseni, 888, 892, 1180
H. tuberculata, 898, 900
Haliplectus dorsalis, 704, 711
Halisarca dujardini, 630
Halosphaeria mediosetigera, 692, 694, 697, 710, 711
H. minor, 976
Haminoea vesicula, 977
Haptophyceae, 909
Harengula clupeola, 1188
H. humeralis, 1183
H. pensacolatae, 982, 1206
Harpacticoida (harpacticoids), 602, 603, 645, 668, 723, 727, 763, 765, 798, 1007, 1128–1130, 1132, 1155, 1156, 1161, 1167, 1170, 1171, 1179, 1184, 1221
heart-urchins, 937, 956
Heliocidaris crassipina, 952, 1195, 1228
H. erythrogramma, 938
Helmsporium sp., 694
Helostoma temminckii, 845
Hemacentrotus pulcherrimus, 941, 954, 1153, 1228
Hemichordata, 1168
Hemigrapsus oregonensis, 879
Hemiselmis, 815, 884
H. rufescens, 770, 771, 801, 807, 875, 909, 910, 915
H. virescens, 593, 594, 909
Henricia, 952, 1197, 1201
H. leviuscula, 950
H. sanguinolenta, 946, 950, 958, 960, 1150
Hepatus epheliticus, 874
herring, 969–971, 981, 982, 986, 987, 991, 992, 994, 998, 1010, 1029, 1032, 1033, 1084–1090, 1092, 1094–1100, 1107–1111, 1113, 1131, 1132, 1136, 1155, 1161, 1164, 1176–1178, 1204, 1205, 1214, 1225–1227
herring, Atlantic, 1094, 1100
herring, lake, 1084
herring, Pacific, 1028, 1095, 1100, 1167, 1185, 1224
herring, sea, 1084
herring, thread, 1203
herring, white sea, 1170
Heteramoeba clara, 592–595, 1147
Heterocarpus reedi, 879, 1127
Heterolaophonte sp., 723, 766
Heteromastus filiformis, 726–728
Heterometra savignyi, 947, 1186
Heteropneustes fossilis, 1215
Heterostegina, 1184
H. depressa, 600, 601, 1145, 1204, 1213
Heterotricha (heterotrichs), 602, 623, 1219
Hexapanopeus angustifrons, 760
Hippoglossus hippoglossus, 1031
Hippospongia, 638
H. canaliculata flabellum, 638
H. equina, 632, 637
H. equina var. *elastica*, 632
H. grossypina, 638
H. lachne, 638, 639
Hippothoa hyalina, 718
Hircinia variabilis, 630
Hirudinea, 720
Histriophoca fasciata, 1056, 1097, 1126
Holothuria, 937
H. grisea, 965, 1125, 1191, 1207
H. monacaria, 948
H. scabra, 946, 1177
Holothuroidea (holothurians), 937–939, 943–945, 947–950, 955–957, 962, 965, 966, 1139, 1140, 1143, 1144, 1148, 1150, 1171, 1178, 1183, 1195, 1197, 1205, 1217, 1219, 1224
Homaridae, 859, 1194
Homarus, 859–870
H. americanus, 820–823, 859–862, 864, 865, 867–870, 877, 1126, 1138, 1154, 1159, 1208, 1209, 1216
H. gammarus (syn.: *H. vulgaris*), 820, 859, 860, 864, 867–869, 1159
hookworms, 1106
Hormiscium sp., 694
Hydatina, 1200
H. senta, 1129, 1164, 1187, 1194, 1211, 1225
hydra, 1180, 1183
Hydra, 660, 665, 1138, 1183, 1184
Hydractinia echinata, 651, 658, 659, 666, 667, 1129, 1163, 1170, 1191
Hydractiniidae, 1130
Hydrallmania falcata, 650
Hydrida, 1212
Hydroides, 724, 725
H. dianthus, 724, 822, 1247

- H. hexagonus*, 1157
H. norvegica, 724, 1183, 1209, 1227
H. uncinata, 724
Hydroidea (hydroids), 641, 650–658, 660, 661, 665–667, 713, 722, 935, 951, 954, 1130, 1135, 1137, 1138, 1143, 1144, 1148, 1151, 1153, 1159–1161, 1163, 1167, 1172, 1173, 1175, 1184, 1185, 1189, 1191, 1192, 1196, 1200, 1201, 1205, 1218, 1222–1224, 1227, 1228
Hydromedusae (hydromedusae), 647, 648, 660, 1162, 1192, 1193, 1205
Hydrozoa (hydrozoans), 641, 650–661, 1126, 1136, 1172, 1175, 1192, 1202, 1216, 1224, 1228
Hydrurga leptonyx, 1056, 1097, 1116, 1160, 1196
Hymenaster blegvadi, 950
H. pellucidus, 950
Hymenodora, 858
hymenostomes, 1180
hyperiid, 1224
Hyperoche medusarum, 1224
Hyperoodon ampullatus, 1109
H. rostratus, 1124
Hyphalaster, 950
Hypophthalmichthys molitrix, 845
Hypotricha (hypotrichs), 606, 618, 731, 1221
Hypotrichida, 1183
Hypsiechinus coronatus, 959

Ibacus, 859
I. ciliatus, 871
I. novemdentatus, 871
ictalurids, 1009, 1013
Ictalurus furcatus, 1201
I. punctatus, 1019
I. sp., 1088
Idya furcata, 786, 1141, 1184
Inachus dorsettensis, 1179
Inia geoffrensis, 1035, 1058, 1088, 1109, 1111, 1143, 1198
Insecta (insects), 845, 984, 1173, 1189
Iridaea flaccidum, 945
Iridophycus flaccidum, 953
Isochrysis, 763, 788, 815, 884
I. galbana, 593, 594, 596, 599, 612, 626, 631, 634, 737, 760, 763, 768, 769, 775, 776, 781, 783, 788, 790–795, 801, 807, 815, 906, 909–915, 918, 921–924, 936, 976, 1203
I. sp., 733, 893
Isometra, 947, 957
I. vivipara, 957
Isopoda (isopods), 653, 728, 808, 881, 949, 1205

Jaanus, 859

J. lalandei, 879, 1094, 1150
jellyfish, 642, 654, 1178, 1213, 1222
Johnius hololepidotus, 1094

Kamplaster, 958
Kareius bicoloratus, 1189
kelp, 789, 978, 1010, 1011, 1180
kelp, brown, 726
Keratella, 690
K. cruciformis, 684, 689
K. cruciformis var. *eichwaldi*, 684
Keronopsis rubra, 606, 615, 625, 1221
Klebsiella sp., 695
Kluveromyces aestuarii, 704
Kogia breviceps, 1109
Kogiidae, 1109
krill, 812, 1094, 1098, 1152
kuruma ebi (abi), 851, 852

Labeo rohita, 845, 1189, 1202
Labidocera aestiva, 1158
Lacrymaria marina, 615
Laevicardium mortoni, 910, 926
Lagenorhynchus albirostris, 1109
L. obliquidens, 1040, 1043, 1048, 1054, 1058, 1091, 1109, 1110, 1121
L. obscurus, 1043, 1109
Lagocephalus lunaris spadiceus, 1153
Lagodon rhomboides, 1005, 1124
Lamellibranchia (lamellibranchs; see also Bivalvia), 884, 900, 1159, 1183, 1195
Laminaria, 700, 703, 709, 711, 715, 895, 913
L. digitata, 703, 706, 715
L. hyperborea, 714–716
L. japonica, 953
L. saccharina, 715, 953
L. sinclairii, 698, 700, 711
L. sp., 704, 706, 710, 712, 720
lamprey, 1094, 1095, 1097, 1099
lamprey, sea, 1126
Lanice conchilega, 725–729, 1136, 1174, 1209, 1229
L. sp., 728
Laomedea flexuosa, 722
Lar, 654
Lauderia borealis, 768, 771, 774, 790–794, 796, 797, 976
Leander squilla, 842, 1208
Lebistes reticulatus, 708
Lecane, 685, 1124
L. inermis, 685, 686, 1146, 1189
L. tenuiseta, 1124
Lepadomorpha, 1181
Lepas anatifera, 800, 801, 806, 807
L. pectinata, 800

- Lepastrea bottae*, 664
Lephopanopeus bellus, 879
Lepidodermella squamata, 685
Lepralia, 713
Leptasterias aequalis, 950
L. arctica, 958, 960
L. groenlandica, 958
L. hexactis, 950, 958, 960, 1138, 1188, 1196
L. mülleri, 958, 960
L. ochotensis, 958, 960
L. ochotensis similispinus, 1177
L. pusilla, 958
Leptoclinum sp., 662
 Leptomedusae, 651, 1224
Leptonychotes weddelli, 1074, 1097, 1103, 1116, 1173, 1186
Leptosynapta inhaerens, 946, 948, 1144
L. minuta, 957
L. sp., 948
Leptychaster alumnus, 958
L. kerguelenensis, 958
L. uber, 959
Lernaediscus galathea, 806, 1220
Leucandria aspera, 630
Leuciscus leuciscus, 1089
Leuckartiara octona, 654
Leucosolenia botryoides, 637
L. complicata, 633, 637, 1172
L. lieberkühni, 630
L. primordialis, 630
Leucothrix mucor, 864
Leuresthes tenuis, 979, 1144, 1187
Libinia emarginata, 760
Lichenopora sp., 718
Limacina, 935
L. sp., 642
Limanda limanda, 1031
Limapontia depressa, 887
 Limnotrachilina, 1202
Limulus polyphemus, 706
Linckia, 952
L. columbiae, 1125
 lingcod, 1088
Liopsetta obscura, 1178
Lissodelphis borealis, 1040, 1053, 1109
Lissodendoryx carolinensis, 633
Lithophaga bisulcata, 926, 927, 1143
Litonotus lamella, 615
Littorina, 1214
L. littorea, 658, 728
L. picta, 889, 894, 895, 1214
L. pintade, 896, 1139, 1214
L. scabra, 1214
L. sp., 879
Lizzia sp., 648
 loach, 1204
Lobodon carcinophagus, 1056, 1093, 1098, 1116, 1179
 lobsters, 812–815, 821–823, 851, 859–873, 882, 883, 1126, 1128, 1133, 1138, 1143, 1144, 1159, 1164, 1168, 1176, 1187, 1192, 1194, 1201, 1203, 1207, 1208, 1212, 1216, 1217, 1226
 lobster, American, 820, 859, 1154, 1159, 1164, 1209
 lobster, Bermuda spiny, 871, 1215
 lobster, California spiny, 1145
 lobster, European, 820, 859
 lobster, Norwegian, 870
 lobster, rock, 883, 1138
 lobster, sand, 1203
 lobster, Spanish, 859, 871–873
 lobster, spiny, 582, 859, 871–873, 1150, 1181, 1195, 1206, 1217, 1218
Loligo brevis, 1101
L. sp., 1109
 Lophophorates, 1214
Lovenella (=Eucheilota) clausa, 651
Lucifer chacei, 838, 1229
 lugworms, 720, 722, 737, 742, 1144, 1223
Luidia ciliaris, 950, 960
L. clathrata, 950
L. foliolata, 950
L. sarsi, 950, 1150
Lulworthia floridana, 694
L. sp., 694
Lumbricus, 737
L. terrestris, 656, 671, 726, 738, 742, 808, 821, 878
 lumpfish, 1097
Lyasterias, 959
L. belgicae, 959
L. chirophora, 959
L. perrieri, 959
Lyngbya, 978, 1007
Lytechinus pictus, 939, 941–944, 964, 965
L. sp., 816, 873
L. variegatus, 941, 942, 945, 946, 953, 954, 964, 1190
 lythe, 1097
 maasbanker, 1094
 mackerel, 1084–1086, 1088–1090, 1094–1099, 1101, 1107–1111, 1113
 mackerel, Atka, 1095, 1099
 mackerel, Atlantic, 1101, 1209
 mackerel, common, 1089
 mackerel, horse, 1010
 mackerel, Jack, 1013, 1168
 mackerel, Pacific, 1095, 1101
 mackerel, Spanish, 1084, 1089, 1095
Macoma calcarea, 1096

- M. nasuta*, 900, 1168
Macrobrachium, 842–846, 1226
M. acanthurus, 842–844, 1139
M. americanum, 843, 1126
M. australiense, 843, 1150
M. caementarius, 846
M. carcinus, 842, 843, 1139
M. formosense, 846, 1211
M. intermedium, 842, 843
M. malcolmsoni, 846
M. niloticum, 843
M. olfersii, 843, 1147
M. rosenbergii, 583, 817, 818, 824, 837, 843–846, 1153, 1182, 1225
M. rude, 846
Macrocystis sp., 953
Macrones aor, 1109
 macrophytes, 697, 702
Macropodia longirostris, 1179
Macrura, 813, 1134
Mactra sachalinensis, 936
M. (=Spisula) solidissima, 901, 926
M. sp., 1107
M. sulcataria, 926, 927, 936
M. veneriformis, 926, 927, 1170
Maia squinado, 1179
 Malacostraca (malacostracans), 742, 808–884, 947, 966, 1033
Mallotus villosus, 1100
Malpodia arctica, 1096
 Mammalia (mammals), 580, 583, 1021, 1023, 1027, 1033, 1035–1123, 1125, 1136, 1139, 1140, 1155, 1157, 1161, 1162, 1165, 1166, 1169–1172, 1174, 1175, 1177, 1182, 1186, 1187, 1194, 1196, 1203, 1208, 1211, 1222, 1227
 manatee, 1050
 mangroves, 704, 1167
Manicina areolata, 664
Margelis, 654
Margelopsis haeckeli, 651, 653, 1223
Marginopora vertebralis, 601, 1205
Marthasterias, 951
M. glacialis, 950, 952, 1150, 1219
Mastigias papua, 643, 644, 1215
Meandra areolata, 1132
Mediaster aequalis, 950
 medusae, 641–645, 647–650, 653, 654, 658, 666, 975, 1096, 1135, 1201, 1205, 1215, 1228
Meganyctiphanes, 811
M. norvegica, 810, 1185
Melanogrammus aeglefinus, 983, 988, 1179
Mellita quinquesperforata, 945
Melosira, 978
M. nummuloides, 673
Membranipora, 713
M. membranacea, 709, 714–718, 1194
M. sp., 718
M. villosa, 718
 menhaden, 1009
Menidia menidia, 1205, 1209
Meningodora, 879
Menippe mercenaria, 839, 840, 874, 876, 1190
Mercenaria, 1222
M. (=Venus) campechiensis, 901, 926, 1215
M. mercenaria, 901, 905, 906, 908, 910–914, 916, 917, 925, 926, 928, 934, 936, 1136, 1137, 1144, 1165, 1215
Mercierella enigmatica, 725, 1145, 1205
Meretrix lusoria, 926, 936
Merga galleri, 651, 1134
Merismopedia, 1006
Merluccius capensis, 1094
M. productus, 1010
M. sp., 1096
 Mesogastropoda, 1214
Mesoplodon bidens, 1113, 1147
Metacrinus, 947
Metafolliculina, 625
M. andrewsi, 602, 603, 1219
Metapenaeus, 846, 847
M. affinis, 847, 1155
M. brevicornis, 847, 1155
M. dobsoni, 847, 1155, 1220
M. ensis, 846, 847, 1138, 1195
M. monoceros, 847, 858, 1155
 Metazoa (metazoans), 583, 592, 640, 1146, 1208, 1225
Metoncholaimus, 697
M. pristiurus, 697, 1139
M. scissus, 697, 706, 711, 1167, 1188
M. sp., 1167, 1188
Metridia, 780, 781
M. longa, 780, 793, 954, 1161
M. lucens, 780, 781, 793, 1161
Metridium dianthus, 661, 1155
Miamiensis avidus, 607–609, 625, 1173
M. sp., 607–610, 625
Microciona fallax, 632
M. prolifera, 628, 630, 631, 633, 637, 1154, 1211
M. spinosa, 630
Micrococcus, 857
M. sp., 599, 695, 696, 702, 712
Microcyphus rousseaui, 954
Microcystis, 978
Micromonas, 815, 884
M. minutus, 911, 912, 922
M. pusilla, 801, 875, 909
M. squamata, 634
Micromonospora sp., 999
Microporella ciliata, 718
 microsporidians, 706

- Microstomus kitt*, 980, 981, 1031, 1167
 milkfish, 845, 978, 1005, 1006, 1138, 1165, 1208, 1221
 minnows, 871
Mirounga, 1077
M. angustirostris, 1039, 1058, 1064, 1074, 1077, 1090, 1092, 1098, 1102, 1116, 1119, 1199
M. leonina, 1057, 1073, 1074, 1092, 1098, 1104, 1107, 1108, 1116, 1118–1120, 1137, 1156, 1179, 1182, 1193, 1219
Misgurnus fossilis, 1204
Mitella mitella, 1228
Mitrocomella (= *Cuspidella*) *brownei*, 651
Modiolus ater, 949
M. demissus, 901
M. modiolus, 879, 1227
Moirá, 953
Molliensia formosa, 1172
 Mollusca (molluscs), 580, 582, 583, 623, 632, 640, 641, 653, 656, 661, 678, 715, 724, 726, 728, 742, 766, 789, 808, 815, 820, 821, 840, 845, 849, 865, 871, 875, 877, 878, 884–936, 948–954, 960, 978, 1033, 1076, 1084, 1085, 1093, 1096, 1097, 1099, 1108, 1136, 1138, 1140, 1150, 1153, 1157, 1159, 1169, 1183, 1187, 1193, 1206, 1222
Molpadia intermedia, 951
Monachus monachus, 1057
M. schauinslandi, 1057, 1098, 1119
M. tropicalis, 1057
Monas sp., 892
Monhysterá, 697–701
M. denticulata, 697–700, 711, 1217
M. disjuncta, 698, 700, 701, 703–705, 707, 711, 1155
M. filicaudata, 700, 701, 711, 1217
M. parelegantula, 704
 monhysterids, 1225
Monocelis, 671, 672
M. fusca, 671, 672, 1156
M. lineata, 672
Monochrysis, 689, 821, 893
M. lutheri, 593, 594, 596, 599, 620, 634, 680, 717–719, 760, 789, 892, 909, 910, 915, 922, 976, 1147
Monodon monoceros, 1039, 1058, 1109
 Monodontidae, 1058, 1109
 monogononts, 685, 1146
 Monoplacophora, 884
Monostroma sp., 925
Monostyla, 685, 690
Montastrea cavernosa, 664
Moraxella, 857
Morone saxatilis, 1023
 mosquitoes, 1339, 1386
 mud snail, 818
 mud suckers, 1094
Mugil, 1197, 1138
M. auratus, 1007, 1013, 1124
M. capito, 1007, 1013, 1124
M. cephalus, 845, 979, 1006, 1007, 1022–1025, 1027, 1148, 1165, 1177, 1178, 1193, 1210, 1215, 1228
M. persia, 1007, 1206
M. saliens, 1007, 1124
M. seheli, 1006
M. sp., 817
M. speigleri, 1007, 1206
M. troscheli, 1006
M. waigiensis, 1006
 Mugilidae, 1124, 1219
Mulinia lateralis, 1136
 mullet, 1006, 1023, 1025, 1086, 1089, 1110, 1165
 mullet, fantail, 1096, 1097
 mullet, grey, 845, 1023, 1024, 1138, 1177, 1178, 1193, 1206, 1210
 mullet, striped, 1095–1097, 1210, 1215, 1216
Murex, 935
 Muricidae, 935
 mussels, 660, 789, 810, 828, 833, 871, 879, 882, 900, 917, 926, 927, 945, 946, 949–951, 953, 978–980, 1022, 1097, 1108, 1129, 1134, 1150
 mussel, European, 1187
 mussel, mahogany date, 1143
Mya arenaria, 728, 808, 875, 901, 926, 934, 953
M. truncata, 1096
Mycale, 633
M. contareni, 633
M. fibrexilis, 633
M. sp., 629
Mycobacterium phlei, 695
Mylio macrocephalus, 975, 1019, 1020, 1173
Myrionozoon, 713
 Mysidacea (mysidaceans), 808, 881
 mysids, 665, 728, 808
Mysis oculata, 1099
 Mysticeti (mysticetes), 1035, 1111, 1123
 Mytilidae, 949
Mytilus, 726, 923, 924, 949, 978, 1222
M. californianus, 951, 977
M. edulis, 642, 646–648, 656, 669, 671, 723, 725–728, 808, 821, 827, 833, 875, 901, 908, 915, 919, 921, 923, 924, 926, 927, 934, 936, 951–953, 963, 980, 981, 1022, 1098, 1108, 1129, 1134, 1137, 1150, 1170, 1187, 1192, 1227
M. sp., 816, 873, 977
Myxoderma sacculatum, 950
 Myxophyceae, 1007
Naegleria gruberi, 594–596, 1138

- Nannochloris*, 689, 818
N. atomus, 909, 922
N. oculata, 591, 593, 594, 622
N. sp., 593, 599, 680, 682, 695, 785
Narcine brasiliensis, 1125
narwhal, 1039, 1058, 1109
Nassarius, 889
N. incrassatus, 889, 1179
N. obsoletus, 818, 889, 890, 894, 895, 897, 1196, 1207
N. reticulatus, 887, 889, 892–894, 1179, 1186
N. trivittatus, 890, 1207
N. vibex, 890, 1207
Natantia (natantians), 812, 813, 815, 817, 837, 840–859, 880–882, 884, 1146, 1166, 1187, 1195, 1197, 1202
Naticidae, 935
Nautilus, 884
Navanax inermis, 977
Navicula, 596, 726, 815, 884, 892, 978, 1006, 1007
N. diversistriata, 599, 600
N. incerta, 673
N. pavillardi, 672, 673
N. praetexta, 724
Neanthes arenaceodentata, 736, 742
N. caudata, 1202
Nemaster grandis, 948
Nematobranchion sexspinosus, 810
Nematoda (nematodes), 583, 691–709, 715, 718, 723, 726, 1006, 1138, 1143, 1146, 1149, 1155, 1167, 1172, 1174, 1182, 1188, 1193, 1194, 1216–1219, 1225, 1226
Nematoscelis, 810, 812
N. difficilis, 810, 812, 1157
N. megalops, 812
Nemopsis dofleini, 651, 1192
Neocomatella pulchella, 948
Neocrinus, 947
Neomysis japonicus, 977
Neopanope sp., 822, 1215
Neophoca cinerea, 1055, 1096
N. hookeri, 1055, 1095
Neophocoena, 1198
N. asiaorientalis, 1110
N. phocoenoides, 1058, 1110
N. sunameri, 1110
Neosmilaster, 959
Nephropidae, 1159
Nephrops, 859
Nephropsidea, 813, 859
Nephrops norvegicus, 870, 871, 1150
Nephtys caeca, 728
N. hombergii, 728
N. sp., 1096
Neptunea sp., 1096
Neptunus sanguinolentus, 1200
Nereidae (nereids), 734, 1129, 1156, 1202
Nereilepas, 1142
Nereis, 725–729, 1139, 1141, 1156, 1228
N. agassizi, 726, 1159
N. caudata, 734
N. (Hediste) diversicolor, 671, 725, 726, 728, 1132, 1156, 1161, 1195, 1208, 1223
N. (Neanthes) fucata, 726, 727, 1156
N. grubei, 734, 736, 742, 1202
N. irrorata, 734, 1147
N. (Nereis) limbata, 726, 727, 1157
N. (Eunereis) longissima, 727
N. megalops, 727
N. (Nereis) pelagica, 728, 1129, 1226
N. procera, 726, 1159
N. sp., 728, 766, 977
N. (Neanthes) succinea, 728, 1214, 1228
N. vexillosa, 734, 1171
N. (Neanthes) virens, 671, 728, 1141, 1156, 1159, 1173, 1174, 1181, 1182, 1218
Nereocystis sp., 726
Nigrospora, 694
Nitocra spinipes, 786, 1128
Nitzschia, 596, 599, 662, 713, 726, 766, 815, 818, 853, 884, 892, 893, 978, 1006, 1007
N. acicularis, 599, 600, 694, 695, 710
N. angularis var. *affinis*, 673
N. brevirostris, 599, 673
N. closterium, 695, 728–730, 763, 764, 788, 791, 803, 889, 976
N. closterium forma *minutissima*, 804, 942
N. communis, 668
N. dissipata, 672, 673, 1131
N. marginata, 673
N. ovalis, 668
N. sigmoides, 821, 826
N. sp., 719, 733, 785, 787, 789, 876, 889, 944, 976
Noctiluca, 1148
N. miliaris (syn.: *N. scintillans*), 590, 591, 622, 1159, 1185, 1219
Notocidaris gaussensis, 959
Notocrinus, 957
Notops branchionus, 684
Notostomus auriculatus, 879
Notothenia, 1098
nototheniids, 1097
Nudibranchia (nudibranchs), 935, 977
Nummulitidae, 1204
Nyctiphanes simplex, 810, 811
Obelia, 650, 654, 659, 1130, 1143, 1160–1162, 1168
O. sp., 642, 651
Ochromonas, 618, 619

- octocorallians, 662
Octomeris angulosa, 799
 octopus, 884, 1094–1099
Octopus sp., 1098
Odinella nutrix, 959
 Odobenidae (odobenids), 1056, 1064, 1096, 1116
Odobenus rosmarus, 1072–1074, 1076, 1077, 1093, 1096, 1102, 1107, 1116, 1119, 1159, 1186, 1201, 1203
O. rosmarus divergens, 1056, 1107, 1135
O. rosmarus rosmarus, 1056
Odontaster validus, 950, 1197
 Odontoceti (odontocetes), 1035–1049, 1051–1054, 1058–1065, 1069, 1071–1073, 1075–1077, 1082, 1084, 1085, 1088, 1090, 1092, 1093, 1104, 1105, 1108–1112, 1116, 1121, 1123
Oikomonas, 616
O. dioica, 981
Oithona brevicornis, 785, 786
O. nana, 786, 1192
 Oligochaeta (oligochaetes), 656, 661, 678, 710, 720, 726, 735, 737, 739, 808, 1172, 1208
Olinthias sp., 654
Olisthodiscus sp., 892, 910, 922, 976
Ommastrephes pacifica, 828
O. sagittatus, 1098
O. sloani pacificus, 828
Ommatophoca rossi, 1098
 oncholaimids, 697
 oncholaims, 1139
Oncholaimus, 1139
O. brachycercus, 704, 706, 707, 712
O. dujardini, 697, 1208
O. paralanguensis, 708
O. sp., 704, 712
Oncorhynchus, 1005, 1015, 1160
O. gorboscha, 1004, 1030, 1134
O. kisutch, 1013, 1016, 1017, 1030, 1196, 1229
O. nerka, 1004, 1019, 1022, 1134
O. tshawytscha, 1013, 1015, 1030, 1146
Ophelia bicornis, 725, 1226
Ophiactis, 956
O. arenosa, 946, 1214
O. lymani, 956
O. nidarosiensis, 956
O. profundis, 956
O. simplex, 946
O. virens, 956
Ophiocoma scolopendrina, 954, 1186
Ophiocoma nigra, 954, 1151
Ophiocten hastatum, 954
Ophiolepis elegans, 954, 963, 1213
Ophionereis annulata, 946
Ophioplocus esmarki, 959
Ophiothrix angulata, 963
O. fragilis, 947, 954
O. spiculata, 954, 1127
 ophiurans, 1192
Ophiura lütkeni, 954, 1127
 Ophiuridae, 1212
 Ophiuroidea (ophiuroids), 937, 939, 943, 944, 947, 949, 950, 954–956, 959, 963, 965, 966, 1127, 1135, 1150, 1151, 1184–1186, 1191, 1208, 1213
Ophlitaspongia seriata, 633–635, 1153
Ophriophragmus filograneus, 963
Ophryotrocha, 729–731, 1168
O. diadema, 730, 736, 742, 1124
O. labronica, 729, 730, 736, 742, 1124
O. puerilis, 731, 734, 1124, 1127, 1162, 1191, 1198
O. puerilis siberti, 1127
 Opisthobranchia (opisthobranchs), 666, 667, 887, 895, 896, 900, 1178
Opisthonema oglinum, 1203
Oplophorus spinosus, 879
 Orcaelidae, 1110
Orcaella brevirostris, 1110
Orcaster reticulatus, 950, 1217
Orcinus, 1162
O. orca, 1041–1043, 1046, 1047, 1052–1054, 1058, 1060, 1065, 1069, 1075, 1088, 1091, 1092, 1110, 1111, 1113, 1123, 1131, 1136, 1158, 1165, 1193, 1216
Orthasterias kochleri, 950
Oscarella lobularis, 630, 631
 Osmeridae, 1100
Osmerus eperlanus, 1096
O. mordax, 1086, 1088, 1101, 1155
Osteochilus hasselti, 845
 ostracods, 726, 978
Ostrea, 874, 908, 1222
O. chilensis, 901
O. edulis, 901, 902, 904–916, 918, 919, 921–926, 933, 936, 977, 1129, 1140, 1144, 1157, 1164, 1204, 1222
O. gigas, 925, 926
O. lurida, 874, 901, 926
O. lutaria, 901, 919, 1143
O. virginica, 926, 1154, 1183, 1200
Otaria byronia, 1090, 1096, 1116, 1160
O. californianus, 1203
O. flavescens, 1055, 1220
 Otariidae (otariids), 1055, 1064, 1087, 1094, 1105, 1116
 Otocelidae, 668
Otocelis (Parotocelis) luteola, 672, 673, 1177
O. rubropunctata, 668, 669, 677
O. westbladi, 668, 669, 677
 otters, 1143

- Oxyrrhis marina*, 591, 619, 622, 716, 718, 719, 731, 976, 1147
O. sp., 723, 726, 942, 976
 Oxytrichidae, 1221
 oysters, 582, 631, 643, 689, 728, 818, 821, 825, 857, 900–902, 904, 908, 910, 911, 913, 916–922, 924, 925, 928–934, 936, 937, 945, 949, 977, 979, 1020, 1127, 1129, 1133, 1137, 1140, 1144, 1147, 1149, 1153, 1154, 1156, 1159, 1161, 1167–1169, 1176, 1182, 1183, 1185, 1187, 1189, 1190, 1193, 1200, 1203, 1206–1208, 1219, 1222, 1223, 1225, 1226, 1228
 oyster, American, 901, 902, 1135, 1136, 1143, 1144, 1154, 1165, 1182, 1184, 1192, 1200, 1214, 1220
 oyster, European, 1144, 1204
 oyster, European flat, 901
 oyster, flat, 902
 oyster, mangrove, 902
 oyster, Olympia, 1260
 oyster, Pacific (Japanese), 901, 902, 930, 934, 1084, 1134, 1183, 1188, 1196, 1200, 1222
 oyster, pearl, 950, 951, 1164, 1176, 1178
 oyster, Portuguese, 902
 oyster, slipper, 902
 oyster, Sydney rock, 902

Pachydrilus lineatus, 656
Pachygrapsus crassipes, 854, 1165
Paedocline doliiformis, 885, 886, 890–893, 897, 899, 900, 1178,
Pagophilus groenlandicus, 1054, 1057, 1098, 1103, 1118, 1120, 1141, 1209
Pagrus major, 979
 Paguridae (pagurids), 813, 1156, 1163
Pagurus, 877
P. hirsutiussculus, 879
P. longicarpus, 821, 822, 824–826, 877, 1203
P. marshi, 877, 1199
P. samuelis, 1140
P. variabilis, 877, 1206
Palaemon, 847–849, 1210
P. japonicus, 1110
P. macrodactylus, 848, 849, 1182
P. serratus, 760, 815, 826, 828, 847, 848, 1142, 1152, 1198, 1201, 1202, 1225, 1227
Palaemonetes, 849–851, 1134, 1210
P. antennarius, 849
P. argentinus, 849, 851, 1188
P. cummingsi, 849, 851, 1146
P. intermedius, 849–851, 1134, 1167
P. kadiakensis, 849, 851, 1134, 1167
P. paludosus, 849, 851, 1146
P. pugio, 817, 819, 849, 851, 1134
P. varians, 1159, 1187

P. vulgaris, 817, 819, 849, 851, 1149, 1176, 1206
 Palaemonidae (palaemonids), 817, 842, 1139, 1146, 1147, 1150, 1159, 1166, 1167, 1176, 1193, 1208, 1210, 1213, 1226
Palmella, 688
Panagrellus, 701
P. redivivus, 707
P. sp., 701, 708, 712, 1172
Pandalus, 851, 852
P. jordani, 851, 852, 879, 1144, 1189
P. montaguvi, 879, 1211
P. platyceros, 851, 879, 1136
Pandorina sp., 688
Pangasius, 1156
Panulirus, 859, 872, 873
P. argus, 871, 872, 1215, 1218
P. elephas, 873
P. homarus, 871, 1217
P. inflatus, 873
P. interruptus, 815, 816, 872, 873, 1145, 1181
P. japonicus, 873
P. longipipes, 873
P. polyphagus, 872, 873, 1195
Paracalanus crassirostris, 785
P. parvus, 785
Paracentrotus lividus, 941, 942, 946, 961, 1196
Parachaster sp., 950
Paralichthys olivaceus, 991, 1228
Paralithodes camtschatica, 879, 880, 1207
Paramecium, 601, 602, 610, 611, 1193, 1202, 1212, 1213, 1221
P. aurelia, 601, 615, 619, 1154, 1189, 1212, 1216, 1221
P. calkinsi, 610, 625, 1145
P. caudatum, 601, 617, 1154, 1181, 1202, 1214
P. sp., 688
P. trichium, 610
Parapenaeopsis stylifera, 879, 1220
Parauronema virginianum, 607–610, 625
Parotocelis luteola, 1177
Parribacius antarcticus, 871
 parrot fish, 1094
Patellina, 596
Patiria miniata, 944, 950, 952, 962, 964, 965, 1125, 1187
Pavlova gyrans, 922
Pavona, 952
Pecten, 726, 1187
P. irradians, 901, 926
P. maximus, 901, 903, 925, 926, 1159
P. (Patinopecten) yessoensis, 926, 927, 1175
Pectinaria koreni, 1226
Pectinaster hispidus, 950
Pedalion, 690
Pediastrum sp., 726
Pedicellaster magister, 950

- Pelagia perla*, 1145
Pelagothuria, 948
Pelecanoides sp., 1097
 Pelecypoda (pelecypods; see also Bivalvia), 884, 900
Pelodera (Rhabditis) strongyloides, 707
Peltogaster paguri, 806
Peltogasterella gracilis, 806
Penaeidia, 1195
 Penaeidae (penaeids), 813, 814, 833, 837, 847, 848, 858, 882, 1125, 1138, 1140, 1141, 1146, 1149, 1153, 1155, 1160, 1166, 1177, 1186, 1189, 1196, 1197, 1211, 1215, 1220, 1223, 1229
Penaeus, 856–858, 1167
P. aztecus, 820, 824, 825, 827, 833–838, 853, 856, 857, 1135, 1152, 1213, 1220, 1229
P. aztecus aztecus, 1141
P. duorarum, 856, 857, 1146, 1149
P. duorarum duorarum, 1141
P. indicus, 858, 1189
P. japonicus, 817, 818, 820, 823, 824, 827–833, 837, 851–856, 1128, 1139, 1145, 1153, 1166, 1167, 1175, 1216, 1218
P. kerathurus, 848, 854, 857, 1183, 1186, 1218
P. latissulcatus, 857
P. merguensis, 847, 858, 1110, 1165
P. monodon, 847, 856, 858, 1132, 1136, 1145, 1189, 1221
P. penicillatus, 1110
P. schmitti, 858, 1197
P. semisulcatus, 858
P. setiferus, 824, 856, 858, 1163, 1171, 1181, 1197, 1225
 penguins, 1095, 1097
Penicillum, 1000
P. notatum, 1000
Pennaria, 1130, 1201
P. tiarella, 660, 1200
 Pennatae, 673
Pentaceraster gracilis, 950
Peranema, 618
P. trichophorum, 618
 perch, ocean, 1084, 1095, 1109
 perch, silver, 1124
 perch, yellow, 1084
 peridineans, 713, 719, 726
Peridinium, 978
P. sp., 596
P. trochoideum, 605, 625, 771
Perigonimus, 654
Perinereis cultrifera, 734, 1147
 periwinkles, 978
Pestlotia sp., 694
 petrel, diving, 1097
Petricola pholadiformis, 901, 926
Petrolisthes eriomerus, 879
Petromyzon marinus, 1126
Phaeocystis pouchetti, 915
Phaeodactylum, 766, 815, 884, 893
P. sp., 615, 789, 980
P. tricornutum, 593, 594, 596, 599, 604, 606, 625, 673, 717, 719, 760, 763, 764, 766–768, 775, 777–781, 788–790, 792, 793, 795–797, 801, 804, 805, 807, 817, 875, 889, 892, 894, 910, 922, 936
Phialidium, 654
P. variable, 654
Philaster digitiformis, 976
 philasterids, 615
Philodina, 685
P. acuticornis var. *odiosa*, 686
P. gregaria, 685, 1146, 1161
Phoca foetida sibirica, 1075
P. groenlandica, 1076, 1086, 1118, 1155, 1211
P. hispida, 1185
P. largha, 1057
P. richardii, 1207
P. vitulina, 1037, 1038, 1053, 1057, 1060, 1061, 1064, 1073–1076, 1086, 1087, 1090, 1098, 1107, 1108, 1118, 1120, 1121, 1137, 1144, 1151, 1161, 1163, 1171, 1202, 1217, 1220
P. vitulina geronimensis, 1039
P. vitulina vitulina, 1057
 Phocidae (phocids), 1054, 1056, 1064, 1087, 1097, 1102, 1116, 1185
Phocoena, 1162
P. dalli, 1040
P. phocoena, 1042–1044, 1046, 1052, 1058, 1061, 1065, 1075, 1089–1092, 1110, 1112, 1113, 1125, 1151, 1212
 Phocoenidae, 1058, 1110
Phocoenoides dalli, 1041, 1091
P. dalli dalli, 1110
P. dalli truei, 1110
Phoma sp., 694
Phormidium, 978, 1006
P. sp., 789
 Phoronida, 1168, 1214
Phoronis muelleri, 1164
Phragmatopoma californica, 734, 1144
P. lapidosa, 734
Phrixometra, 957
Phyllophorus urna, 957, 1183
Phyllospadix sp., 952
Physeter catodon, 1059, 1109, 1112, 1154
P. macrocephalus, 828
 Physeteridae, 1109
 pike, 1086
 pike, blue, 1084
 pilchards, 994, 998, 1094, 1131
Pilumnus sayi, 874

- Pinctada fucata*, 1178
P. margaritifera, 926, 1209
P. martensi(*i*), 926, 1176, 1221
P. maxima, 926, 1221
Pinnipedia (pinnipeds), 1035–1038, 1043–1045, 1051–1054, 1059–1064, 1072–1077, 1082, 1084, 1085, 1087, 1090, 1092–1094, 1100, 1102–1105, 1108, 1116, 1117, 1121, 1129, 1130, 1148, 1155, 1161, 1162, 1167, 1174, 1182, 1185, 1193, 1197–1199, 1211, 1214
Pinnotheres, 1142, 1179
Pinnotheridae, 1162
Pisaster, 951, 1178
P. brevispinus, 950, 1212
P. giganteus, 950, 951
P. ochraceus, 950, 951, 954, 1150, 1188
Pisces (fishes), 580–583, 621, 623, 640–642, 648, 653, 656, 660, 661, 678, 679, 683, 688, 689, 708, 715, 728, 737, 739, 742, 747, 755, 757, 758, 762, 766, 772, 786, 787, 789, 798, 807, 808, 815–817, 820, 821, 825, 828, 833, 835, 836, 840, 841, 843, 845–847, 853, 858, 871, 873, 875, 878, 882, 884, 894, 906, 915, 932, 933, 935, 948–950, 952, 960, 961, 966, 968–1035, 1047, 1053, 1054, 1063, 1066, 1068, 1070, 1071, 1076, 1077, 1082–1088, 1090, 1092–1098, 1100–1102, 1107–1111, 1114, 1120, 1125–1127, 1131–1138, 1142–1145, 1148, 1149, 1151, 1152, 1154–1157, 1160, 1162–1173, 1175, 1177–1182, 1184, 1186–1190, 1192, 1195, 1196, 1198, 1200, 1202–1205, 1207, 1209, 1210, 1212–1215, 1217, 1218, 1220, 1224, 1225, 1227–1229
Pitar (= *Callocardia*) *morrhua*, 901, 928
Placopecten magellanicus, 1145
plaice, 760, 971, 980, 981, 991, 994, 998, 1013, 1015, 1031, 1098, 1124, 1131, 1142, 1178, 1200, 1203, 1210, 1227, 1228
planarians, 671
Planktoniella, 1006
Plasmodium, 619
Platanista gangetica, 1049, 1075, 1109, 1198
P. indi, 1058, 1089, 1092, 1109, 1156, 1198
Platanistidae, 1058, 1109
Platessa pseudoflesus, 1196
Platichthys flesus, 993, 1031–1033, 1219
P. stellatus, 1195
Platinopecten yessoensis, 936
Platyhelminthes, 728, 1171
Platymonas, 591, 596, 763, 788, 1131
P. convolutae, 670, 671, 1131, 1177
P. ellipta, 754
P. sp., 591, 622, 731, 776–778, 781, 793, 794, 806, 810, 910
P. subcordaeformis, 746, 763
P. subcordiformis, 809, 810, 976
P. suecica, 767, 778–781, 790, 793, 915
P. tetrathele, 612, 626, 760
Platynereis dumerilii, 724, 731, 732, 734, 1150, 1163, 1166
P. megalops, 1172
Plecoglossus altivelis, 1022, 1028, 1166, 1210
Plesionika martia, 880
Pleurobrachia pileus, 1158
Pleurococcus, 662, 713
Pleuronectes platessa, 969, 979–981, 987, 994, 997, 998, 1005, 1013–1015, 1030, 1031, 1124, 1142, 1178, 1200, 1203, 1219
Pleuronectidae (pleuronectids), 1031, 1200, 1203
Pleuronichthys sp., 998
Pleurosigma, 978, 1006
P. balticum, 697
Plezechinus nordenskjöldi, 959
Plocamium coccineum, 726, 728
Plumaria elegans, 727, 728
Plumularia, 650, 1130
Pocillopora, 952, 1214
P. damicornis, 662–664, 952, 1139, 1201, 1221
P. damicornis cespitosa, 1127
P. meandrina, 664
Podocoryne carnea, 651, 660, 1133
P. hartlaubii, 651, 1228
Podophrya, 616
P. collini, 615, 1168, 1196, 1204
P. sp., 616
Poecilia latipinna, 981
P. reticulata, 981
Pogonophora, 1168
Polinices, 935
Pollicipes polymerus, 806, 1181
P. spinosus, 799, 1129
pollock (pollack), 991, 1013, 1084, 1094, 1095, 1097, 1098
Polychaeta (polychaetes), 666, 678, 708, 715, 720–737, 739, 740, 742, 765, 821, 822, 884, 949, 950, 1124, 1127, 1130, 1136, 1139, 1143, 1144, 1147, 1148, 1150, 1155, 1156, 1159, 1161, 1163, 1164, 1166, 1167, 1173–1177, 1198, 1202, 1209, 1221, 1223, 1227, 1229
Polydora, 934
P. ciliata, 733, 740, 934
Polygordius, 724, 1142
Polyplacophora, 884
Polysiphonia, 597
Polytoma, 688
P. uvella, 618
Polytomella caeca, 686
Polyzoa (polyzoans), 954, 1206
Pomatoceros, 733, 874, 1217

- P. sp.*, 977
P. triquetus, 732, 733, 736, 1151, 1176, 1209
Pomatomus saltatrix, 1092, 1145
Pomolobus mediocris, 1092
P. pseudoharengus, 1092
Pontaster tenuispinus, 951
Poppiana argentinianus, 1111, 1198
Porania, 952
P. antarctica glabra, 951
P. pulvillus, 951, 952
Poraster superbus, 951
Porcellanaster coeruleus, 951
P. sp., 951
Porcellanasteridae, 1186
Porella sp., 718
 porgy, black, 1019, 1020, 1173
Porifera, 583, 627-641, 966, 1126, 1130, 1134, 1153, 1201, 1222
Porites, 1214
P. compressa, 664
P. porites, 664
Porolithon sp., 945
Poronotus sp., 1110
P. triacanthus, 1092, 1101
Porphyra umbilicalis, 726
Porphyridium, 818, 911
P. cruentum, 593, 594
P. sp., 911
 porpoises, 1042, 1050, 1062, 1113, 1115, 1136, 1150, 1173, 1181, 1194, 1200, 1201, 1211, 1212, 1218, 1227
 porpoise, Atlantic bottlenose, 1128
 porpoise, common, 1151
 porpoise, Dall's, 1040, 1110
 porpoise, finless black, 1058, 1110, 1198
 porpoise, harbour, 1042, 1046, 1058, 1090, 1110, 1113, 1125, 1212, 1226
 porpoise, spinner, 1198
 porpoise, spotted, 1198
 porpoise, True's, 1110
Portunidae (portunids), 1134, 1195
Portunus gibbessi, 874
P. sayi, 874
P. sp., 728
Postelsia palmaeformis, 698
Potamolepidae, 627
Prasinocladus marinus, 671
Prasinophyceae, 909
 prawns, 760, 812, 813, 815, 818, 827, 829, 840-859, 881, 1136, 1138, 1142, 1145, 1149, 1152, 1153, 1155, 1159, 1166, 1167, 1172, 1175, 1177, 1195, 1198, 1201, 1210, 1211, 1220, 1225
 prawn, banana, 1165
 prawn, bori, 1128
 prawn, English, 1198, 1202
 prawn, giant, 844, 1153
 prawn, Indian, 1189
 prawn, jumbo tiger, 1189
 prawn (shrimp), kuruma, 851, 1167, 1175, 1211, 1216
 prawn, spot, 851
 prawn, western king, 857
 priapuloids, 1096
Priapulius caudatus, 1096
Proales decipiens, 1194
Proboscidactyla flavicirrata, 1137
Proceraea cornuta, 734
Procerentrum, 815, 884
P. micans, 778-781, 801, 806, 875, 976
Proseriata, 1156
Prosobranchia (prosobranchs), 885, 892, 894, 895, 900, 935, 1140, 1152, 1189, 1196, 1198, 1207, 1214, 1223, 1228
Proteus mirabilis, 595
P. sp., 695
 protists, 1168
 protobranchs, 935
Protoceratium reticulatum, 976
Protodrilus, 734, 1170
P. rubropharyngeus, 734, 1158
P. symbioticus, 735, 1158
Protohydra leuckarti, 651, 1192
Protohydridae, 1192
Protoreaster lincki, 951
Protozoa (protozoans), 580, 583-627, 689, 709, 718, 726, 731, 739, 781, 785, 808, 845, 856, 897, 918, 947, 948, 953, 954, 975, 976, 981, 1033, 1129, 1131, 1141, 1147, 1149, 1158, 1160, 1166, 1168, 1171, 1172, 1174, 1175, 1181, 1185, 1199, 1206, 1211, 1214, 1221
Prymnesium parvum, 593, 595, 596, 599, 801, 909
Psammechinus, 1197
P. miliaris, 940, 942, 943, 946, 947, 953, 954, 1136, 1139, 1144, 1161, 1205
Pseudaphanostoma psammophilum, 668, 674, 675, 677
Pseudocalanus, 781-783, 820, 1141
P. elongatus, 776, 781, 782, 793, 794, 1141, 1173, 1219
P. minutus, 783, 794, 1199
Pseudocentrotus depressus, 952
Pseudocoelomate, 1168
Pseudocucumis africanus, 957
Pseudodiaptomus coronatus, 786, 1170
P. inopinus, 786, 787
Pseudohaplogonaria vacua, 668, 677
Pseudomonas, 635, 857, 917, 999
P. fluorescens, 695
P. pyocyanea, 595

- P. sp.*, 599, 613, 626, 695, 696, 701, 702, 708, 709, 711, 712
Pseudorca crassidens, 1043, 1053, 1069, 1075, 1091, 1110
Pseudostichococcus monallantoides, 734
Psilaster andromeda, 951
P. pectinatus, 951
Psolidium incubans, 957
Psolus antarcticus, 957
P. ephippifer, 957
P. figulus, 957
P. granulatus, 957
P. koehleri, 957
P. punctatus, 958
Pteraster, 959
P. tessellatus, 951, 1204
Pteria macroptera, 926, 1209
Pterodina, 690
P. patina, 684
 pteropods, 885, 890, 892, 893, 897, 1140, 1178
Ptilosarcus guernei, 663, 1138
 puffers, 1010, 1019, 1020, 1084, 1098, 1153
Pugettia gracilis, 879
Pusa hispida, 1054, 1057, 1099, 1118
P. sibirica, 1057, 1099
 pycnogonids, 661, 667
Pycnopus helianthoides, 951, 1176
Pygospio elegans, 740
Pyramimonas, 818, 893
P. grossii, 801, 892, 909, 910, 915
P. ovata, 909, 915
P. sp., 942
Pyrgo, 596
- Quinqueloculina lata*, 597–599
- rabbitfishes, 978, 1006–1008, 1130, 1135, 1198, 1212, 1224
 radiolarians, 621, 951
Rana sylvatica, 1392
Rangia cuneata, 1136
Rapana thomasi, 931
Raspailia viminalis, 630, 637
 ratfish, 1098
Rathbunaster californicus, 951
Rathkea, 1130
R. octopunctata, 651–653, 658, 1223
 ray, 1097
Reniera alba, 637
R. simulans, 630
 Reptantia (reptantians), 812, 813, 815, 840, 859–880, 882
Retepora, 713
 Rhabditidae (rhabditids), 1146, 1193
Rhabditis marina, 702, 703, 706, 708, 709, 712, 1217
Rhincalanus nasutus, 771, 783–785, 794, 795
Rhithropanopeus harrisi (syn.: *Heteropanope tridentatus*), 760, 822, 877, 878, 1139, 1142, 1152, 1175, 1215
 Rhizocephala, 806, 1228
Rhizocrinus, 947
Rhizophora mangle, 704, 1167
 rhizopods, 726
Rhizorhagium album, 651
Rhizolenia delicatula, 771
R. setigera, 792
R. sp., 976
Rhizostoma pulmo, 645
 Rhizostomeae (rhizostomes), 643, 1136, 1215
Rhodomonas, 763, 788
R. baltica, 768, 769, 790, 791
R. lens, 596, 611, 612, 626, 763, 788
R. sp., 768, 791, 910
 Rhodophyceae, 593
Rhopiella, 959
Rhopilema verrilli, 644–646, 1136
Rhynchocidaridaris triplopora, 959
 roach, 1180
Robulus, 596
Roccus lineatus, 1092
 rockfish, 1084, 1094, 1095, 1097–1099, 1109
 rohu, 845
Rosalina floridana, 1180
R. leei, 597–599
Rosaster florifer, 951
 rosefish, 1097
Rotaliella heterocaryotica, 1158
 Rotifera (rotifers), 580, 583, 641, 653, 678–691, 718, 726, 808, 809, 815, 822, 823, 881, 978, 979, 981–983, 1124, 1129, 1131, 1146, 1148, 1149, 1153, 1156, 1161, 1164, 1166, 1170, 1178, 1189, 1190, 1193, 1194, 1199, 1211, 1215, 1217, 1220, 1225
Rubratella intermedia, 1158
Rutilus rutilus, 1180
- Sabella*, 733, 1217
S. paronina, 1193
S. vulgaris, 1194
Sabellaria alveolata, 734, 1137
S. spinulosa, 734, 737, 742, 1226
S. vulgaris, 733, 1143, 1148, 1194, 1222
 Sabellariidae (sabellariids), 734, 1143, 1144, 1226
 sablefish, 1094
Saccharomyces cerevisiae, 612
S. exiguus, 622
 saccoglossans, 887

- Saccorhiza polyschides*, 715, 1194
Sacculina carcini, 1212
S. sp., 806
Sagitta sp., 642, 654
 saithe, 1097
Salmo gairdneri(i), 1004, 1013, 1014, 1016, 1030, 1156, 1158, 1196, 1229
S. irideus, 970, 1160, 1218, 1220
S. salar, 1017, 1029, 1030, 1167, 1209
S. trutta, 1031
 salmon, 971, 1009-1012, 1017, 1023, 1024, 1028, 1052-1054, 1088, 1094, 1095, 1097, 1099, 1110, 1111, 1136, 1146, 1166, 1218
 salmon, Atlantic, 1017, 1167, 1209, 1218
 salmon, blue back, 1140
 salmon, chinook, 1013, 1018, 1019, 1182, 1196
 salmon, chum, 1084
 salmon, coho, 1019, 1084, 1196, 1229
 salmon, keta, 1084
 salmon, king, 1084
 salmon, Pacific, 1015, 1023, 1125, 1160, 1229
 salmon, pink, 1134
 salmon, red, 1084
 salmon, sockeye, 1004, 1019, 1134
Salmonella cholerae-suis, 595
S. enteritidis, 595
S. meleagridis, 595
S. paratyphi, 595
S. pullorum, 595, 695
S. schottmuelleri, 595
S. typhimurium, 595
S. typhosa, 595
 Salmonidae (salmonids), 970, 1012, 1013, 1029, 1154, 1160, 1182, 1210, 1212, 1227, 1228
Salvelinus fontinalis, 1016, 1022, 1031
 sand dollars, 937, 950, 953, 956, 964, 1218, 1219
 sand lace, 1094, 1095
Sarcina lutea, 595, 695
 Sarcodina, 595
Sardina pilchardus, 994, 997, 998, 1131
 sardines, 1095-1099, 1107, 1109, 1110, 1188
 sardine, Pacific, 1084, 1126
 sardine, scaled, 1206
Sardinops caerulea, 998, 1126
Sargassum seratifolium, 952
S. thunbergii, 952
Sarsia, 654
S. decipiens, 650
S. sp., 648
S. tubulosa, 651
 saury, 1094
Saxicava arctica, 1096
Saxidomus giganteus, 927, 1133
 scad, 1089
 scallops, 582, 903, 921, 949, 1145, 1169, 1175,
 scallop, bay, 701, 711, 1206
 scallop, sea, 1084
 Scaphopoda (scaphopods), 884, 949-951
Scenedesmus, 688, 726
S. obliquus, 913
S. sp., 746, 747, 752
 Schistosomatidae, 1172
Schistosomatium douthitti, 1172
Schizaster fragilis, 953
 schizopods, 1099
Schizoporella, 713
S. sanguinea, 718
S. unicornis, 718
Sciaenops ocellata, 1190
 scleractinians, 664, 1140, 1145, 1184, 1213
Scolecopsis fuliginosa, 736, 1130
Scomber diego, 1092, 1110
S. japonicus, 1023, 1101
S. scombrus, 1089, 1092, 1101, 1209
 Scombridae, 1101
Scophthalmus maximus, 980, 1016, 1017, 1142
Scorpaena guttata, 1144
Scrobicularia plana, 900, 1168
Scrupocellaria, 713
S. reptans, 714, 715, 718
 sculpins, 1095, 1098, 1144
Scylla serrata, 878, 879, 1134, 1149, 1165, 1195, 1200, 1219
 Scyllaridae (scyllarids), 813, 815, 859, 871-873, 1203
Scyllarus, 859
S. americanus, 871, 873, 1203
S. bicuspidatus, 871
 Scyphomedusae, 1161
 Scyphozoa (scyphozoans), 641-648, 1136, 1224
 sea-anemones, 664, 665, 950, 1155, 1157, 1182, 1189, 1192, 1222
 sea-bobs, 1203
 sea-cucumbers, 937, 939, 950, 951, 956, 1109, 1177, 1224
 sea-cucumber, Japanese, 1138
 sea horses, 607
 sea lettuce, 613, 787
 sea-lilies, 937, 947, 956
 sea lions, 1044, 1049, 1050, 1064, 1069, 1104, 1120, 1132, 1143, 1169, 1177, 1193, 1199, 1203, 1207, 1211, 1213, 1226, 1227
 sea lion, Australian, 1055, 1096
 sea lion, California, 1039, 1055, 1059, 1072, 1073, 1096, 1145, 1148, 1150, 1187, 1194, 1198, 1207, 1219, 1225
 sea lion, Galapagos, 1056
 sea lion, New Zealand, 1055, 1095

- sea lion, Northern, 1198
 sea lion, South American, 1055
 sea lion, Southern, 1096, 1160, 1220
 sea lion, Steller, 1055, 1095, 1104, 1106, 1150, 1187, 1196, 1199
 seals, 950, 953, 1044, 1045, 1049, 1050, 1052, 1061, 1069, 1073, 1075, 1076, 1087, 1097, 1102, 1105, 1106, 1110, 1120, 1125, 1132, 1135, 1141, 1144, 1147, 1150, 1162, 1169, 1174, 1181, 1195, 1196, 1199-1201, 1204, 1207, 1208, 1211, 1212, 1220
 seal, Alaska fur, 1129, 1174, 1197
 seal, Atlantic harbour, 1057
 seal, Australian fur, 1055, 1094
 seal, badger, 1161
 seal, Baikal, 1057, 1099
 seal, bearded, 1056, 1097, 1185
 seal, Cape fur, 1200
 seal, Caribbean monk, 1057
 seal, common, 1137, 1161, 1217
 seal, crabeater (krill-eater), 1056, 1093, 1098, 1130, 1179
 seal, elephant, 1039, 1064, 1090, 1130, 1156, 1179, 1187
 seal, fur, 1149, 1150, 1169, 1174, 1183, 1213, 1226, 1227
 seal, Galapagos fur, 1055
 seal, grey, 1056, 1061, 1064, 1097, 1142, 1165, 1181, 1182, 1187
 seal, Guadalupe fur, 1055
 seal, harbour, 1037-1039, 1064, 1075, 1087, 1098, 1144, 1150, 1162, 1169, 1171, 1174, 1196, 1207, 1213, 1226
 seal, harp, 1054, 1057, 1098, 1141, 1155, 1209, 1211
 seal, Hawaiian monk, 1057, 1098, 1203
 seal, hooded, 1056, 1092, 1097, 1148
 seal, Kamchatkan harbour, 1057
 seal, Kerguelen fur, 1055, 1094
 seal, leopard, 1056, 1097, 1160
 seal, Mediterranean monk, 1057
 seal, New Zealand fur, 1094, 1214
 seal, Northern elephant, 1056, 1077, 1092, 1098, 1128, 1199
 seal, Northern fur, 1039, 1055, 1082, 1094, 1126, 1129, 1183, 1198, 1221
 seal, Pacific harbour, 1057, 1207
 seal, ribbon, 1056, 1097, 1126
 seal, ringed, 1054, 1057, 1099, 1185
 seal, Robben fur, 1169
 seal, Ross, 1098
 seal, South African fur, 1055, 1094
 seal, South American fur, 1055
 seal, Southern elephant, 1057, 1092, 1098, 1104, 1107, 1108, 1137, 1182, 1193, 1219
 seal, Victorian, 1185
 seal, Weddell, 1097, 1130, 1173, 1176, 1182, 1186, 1226
 sea nettles, 643
 sea otters, 1035, 1226
 sea-pens, 663, 1138
 sea squirts, 1096
 sea-stars (starfish), 931, 932, 937-939, 943, 945, 946, 949-952, 955, 956, 960, 962, 966, 1097, 1109, 1125, 1130, 1136-1139, 1149-1151, 1153, 1154, 1157, 1161, 1163, 1168, 1169, 1171, 1172, 1176-1178, 1181, 1183, 1186-1188, 1190, 1193, 1194, 1197, 1212, 1217, 1219, 1220, 1223, 1225, 1228
 sea-urchins, 689, 937-946, 949-951, 953, 955, 956, 963-967, 977, 1136, 1144, 1147, 1149, 1153, 1161, 1162, 1165, 1166, 1169, 1170, 1173, 1178, 1179, 1189, 1191, 1192, 1194, 1195, 1197, 1198, 1205, 1209, 1215, 1218, 1219, 1228
 sea-urchin, purple, 953, 1156
 sea wasps—*see* Cubozoa
 seaweeds, 582, 709, 713, 714, 739, 763, 775, 821, 1045, 1189, 1199
 seaweed, brown, 715, 789
 seaweed, red, 669
 Sedentaria, 1223, 1229
Selenastrum, 688
 sepat siam, 845
 Septibranchia, 935
Septosaccus cuenoti, 806, 1220
Sergestes, 858, 1159
S. corniculatum, 859
S. grandis, 859
S. japonicus, 859
S. lucens, 817, 858, 859, 1195
S. similis, 1197
S. splendens, 859
 Sergestidae (sergestids), 813, 858, 859, 1146
Seriola quinqueradiata, 689
Serpula concharum, 1209
 Serpulidae (serpulids), 724, 725, 732, 1145, 1151, 1176, 1205, 1209, 1227, 1229
Serratia marcescens, 695
S. marinorubra, 613, 626
Sertularia, 1130
S. argenta, 1161
S. cupressima, 650
Sesarma cinereum, 1142
 sharks, 1098, 1110, 1199
Shigella dysenteriae, 595
S. flexneri, 1382
S. sonnei, 595
 shrimps, 642, 812-815, 817, 821, 825, 826, 828, 833, 836-838, 840-859, 875, 881, 882, 896, 949, 950, 953, 978-980, 1010, 1084, 1095, 1097, 1099, 1101, 1109, 1110, 1124, 1125,

- shrimps—*continued*
 1134, 1139–1141, 1146, 1163, 1166, 1169,
 1171, 1174, 1179, 1181, 1182, 1184, 1189,
 1193, 1196–1198, 1208, 1211, 1215, 1217–
 1220, 1223, 1226, 1229
 shrimp, brine, 642, 644, 743, 747, 749, 756–
 761, 815, 820, 828, 848, 881, 884, 1125, 1130,
 1133, 1152, 1177, 1178, 1193, 1199, 1207,
 1211–1213, 1222, 1225
 shrimp, brown, 824, 836, 856, 882, 1139, 1141,
 1152, 1213, 1220, 1229
 shrimp, common, 1217, 1225
 shrimp, fairy, 743
 shrimp, grass, 1206
 shrimp, jumbo tiger, 856, 1145
 shrimp, kuruma, 855, 856, 1153
 shrimp, mysid, 828
 shrimp, ocean, 851, 1144, 1189, 1197
 shrimp, pink, 856, 882, 1141, 1146, 1149, 1217
 shrimp, sand, 841
 shrimp, snapping, 841, 1176
 shrimp, white, 824, 856, 1171, 1181, 1197
 shrimp, witch, 1098
 Siganidae (siganids), 1005, 1135, 1187, 1218,
 1224
Siganus (syn.: *Amphacanthus*), 1006, 1218
S. argenteus, 1007
S. canaliculatus (syn.: *S. oramin*), 978, 1007,
 1008, 1023, 1187, 1212, 1224
S. concatenata, 1224
S. fuscescens, 1007, 1153
S. guttatus, 1007, 1008
S. rivulatus, 1007, 1130, 1198
S. rostratus, 1007, 1218
S. spinus, 1007, 1135, 1218
S. striolata, 1224
S. virgatus, 1007
 silkworms, 845
 silverside, 1095
Sinocalanus tenellus, 786, 787
Sinovacula constricta, 936
 siphonophores, 660
 Sipunculida (sipunculids), 1096, 1168
 Sirenia, 1035
 skate, 1095, 1097, 1098
Skeletonema, 815, 884
S. costatum, 593, 768, 771, 774, 776, 781, 790–
 797, 799, 801, 806, 807, 809–811, 818, 820,
 853, 854, 856, 892, 910, 922, 976
 skipjack, 1110
 slugs, 888, 1209
 smelt, 1084–1086, 1088, 1094–1096, 1098,
 1100, 1155
 smelt, American, 1095, 1101
 smelt, Japanese, 1095
 smelt, white bait, 1094, 1095
 snails, 884, 889, 896, 897, 949–951, 1109, 1139,
 1189, 1190, 1221
 snapper, red, 1084
Solaster dawsoni, 951
S. endeca, 951
S. paxillatus, 951
S. stimpsoni, 951
 sole, 981, 992, 993, 1015, 1022, 1110, 1142, 1149
 sole, common, 1151
 sole, lemon, 980, 1031, 1167
 sole, lined, 987
Solea solea, 808, 975, 979–981, 992, 993, 1014,
 1015, 1022, 1151
S. vulgaris, 1149
Solenocera indica, 879, 1177
 solenogasters, 884
Sousa plumbea, 1043
Sparus auratus, 1203
Spatangus purpureus, 953
Sphaerechinus granularis, 941
Sphaeriodiscus (= *Ceramaster*) *placenta*, 951
Sphaeroma quoyanum, 808, 1205
 Sphaeromatidae, 1205
 Spionidae, 740
Spiratella, 897
S. helicina, 897
S. retroversa, 890, 893, 897
Spirillina, 596
Spirogyra, 1006
Spiroloculina hyalina, 597–599
Spirulina sp., 747
Spisula solidissima, 1096, 1101, 1107
 sponges, 627–635, 637–641, 728, 901, 934, 950,
 951, 1126, 1130, 1131, 1134, 1142, 1143,
 1148, 1154, 1168, 1174, 1179, 1180, 1182,
 1184, 1188, 1190, 1196, 1199, 1201, 1202,
 1208, 1211, 1218, 1222, 1223, 1226
 sponge, boring, 632
 sponge, crumb-of-bread, 638
 sponge, grass, 638
 sponge, sheepswool, 638
 sponge, yellow, 638
Spongelia elastica var. *massa*, 630
Spongia, 638
S. agaricina corlosia, 638
S. barbara, 638, 639
S. dura, 638
S. graminea, 638
S. obliqua, 638
Spongilla proliferens, 1223
S. sp., 638
 Spongillidae (spongillids), 627, 629
 sprat, 1099, 1110
Squalus acanthias, 1010
 squid, 823, 827, 828, 832, 882, 884, 950, 979,
 1070, 1076, 1094–1099, 1101, 1109–1111

- Stachybotrys* sp., 694
Staphylococcus sp., 1115
 starfish—see sea-stars
Stauridiosarsia japonica, 651, 1192
S. producta (syn.: *Stauridium productum*), 651, 654, 1162
Staurocladia portmanni, 651, 1134
Staurocoryne, 1201
S. filiformis, 652, 1201
Stegophiura sculpta, 959, 1192
Stelospongia cavernosa var. *mediterranea*, 630
Stenella, 1075
S. attenuatus, 1044, 1054
S. caeruleoalba, 1041, 1044, 1054, 1109
S. dubia, 1058
S. graffmani, 1111, 1112
S. longirostris, 1043
S. microps, 1111, 1112
S. pernettyi, 1113
S. plagiodon, 1112
Stenopodidea, 813
Stephanoscyphus, 1224
S. eumedusoides, 1224
S. planulophorus, 645–647, 1224
S. racemosus, 1224
Sterechinus neumayeri, 953, 1197
Stichaster australis, 951
Stichococcus sp., 910, 976
Stichonus, 937
Stichopus, 948, 1143
S. japonicus, 948, 1138, 1216
 sticklebacks, 1021, 1022, 1094
 stickleback, three-spine, 1185
Stomopneustes variolaris, 954
Stomphia coccinea, 1222
Streblus beccarii var. *tepida*, 1133
Streptocephalus, 743
Streptococcus faecialis, 695
Streptomyces, 1000
S. erythreus, 999
S. fradiae, 1000
S. griseus, 1000
S. kanamyceticus, 999
S. venezuelae, 999
Striatella unipunctata, 792
 Stromateidae, 1101
Strombidium sp., 669
Strongylocentrotus, 954, 1215
S. droebachiensis, 946, 1222
S. intermedius, 945, 952–954, 1153, 1173
S. lividus, 1133
S. nudus, 1153
S. pulcherrimus, 952, 953, 1192, 1195, 1218
S. purpuratus, 939, 941, 942, 945, 946, 952, 953, 956, 977, 1148, 1149, 1157, 1179, 1197
 sturgeons, 737, 1204
Stylifer, 935
Stylocheiron, 809
Stylocidaris affinis, 1166
Stylynychia mytilus, 1154
S. pustulata, 617
S. sp., 975, 976
Stylotella heliophila, 630, 631
Styracaster horridus, 951
S. sp., 951
Suberites arcicola, 637
S. domuncula, 637
S. ficus, 632
S. massa, 630, 638
 sucker, 1086
 Suctorina (suctorians), 615, 1196, 1204, 1205, 1214
 sugpo, 856, 1132, 1136, 1145, 1221
 surf-grass, 952
Suriella, 978
 Susu, 1058, 1109
 swordfish, 1084
Sycon, 635, 636
S. capillosum, 637
S. ciliatum, 635, 636, 1172
S. coronatum, 637
S. raphanus, 630, 631, 635, 637
S. raphanus var. *aquariensis*, 637
S. (Sycandra) setosum, 630, 635
 Syllidae (syllids), 715, 1147, 1161, 1163
Symbiodinium microadriaticum, 596
Synapta minuta, 1129
S. vivipara, 1139
Synaptula hydriformis, 958
Syncoryne, 1130, 1162
S. eximia, 650, 652
Synechococcus elongatus, 909
Syracosphaera carterae, 771
Systellaspis, 880

Taeniogyrus contortus, 958
Tanakius kitaharai, 1153
Tapes japonica, 664, 926, 936
T. semidecussata, 901, 936
Tautoglabrus adspersus, 1005, 1138
Tedania ignis, 630
 Teleostei (teleosts), 1023, 1076, 1124, 1136
 1151, 1172, 1200, 1224
Temora longicornis, 794
T. stylifera, 768, 794, 796, 797, 1154
T. turbinata, 785
 ten-pounder, 1165
 tentaculates, 659
Terebella lapidaria, 734, 1215
T. littoralis, 1222

- terebellids, 1144
Teredo, 874
T. navalis, 901
Tessabrachion oculatus, 810, 811
Tethya aurantium, 637
T. crypta, 629, 630
Tetracitta serrata, 799
T. squamosa, 806
Tetracitella karandei, 806, 1173
Tetrahymina, 601, 602, 617, 618, 1141, 1166, 1214
T. pyriformis, 601, 602, 615, 616, 619, 620, 1148, 1180, 1205
 Tetrahymenidae, 619
Tetraselmis, 815, 884
T. carteriaformis, 593, 594
T. chunii, 604
T. micropapillata, 777, 788, 793
T. sp., 593, 856, 884, 954, 1158
T. suecica (syn.: *Platymonas*), 634, 909, 910, 915, 918, 921-924
T. tetrathele, 593, 594
 Tetraxonida, 637
Thais bronni, 931
T. tumulosa clavigera, 931
Thalassia testudinum, 600, 692, 697, 945
Thalassionema, 1007
Thalassiosira, 1007
T. fluviatilis, 673, 772-774, 783-785, 791, 792, 794, 811
T. nordenskiöldi (i), 780, 793
T. pseudonana, 936
T. rotula, 810
T. sp., 593, 856, 976
Thalassiothrix, 1006
Thalysias juniperina, 630
T. schoenus, 630
 Thecata (thecates), 665, 1224
 Thecaphorae, 651
Thelenota, 937
Themisto libellula, 1099
Theragra chalcogramma, 1153
Theristus pertenuis, 701, 703, 707, 712, 1155
Thoracaster magnus, 951
Thorocomonas, 818
Thunnus alalunga, 1010
Thyone, 948
T. briareus, 962, 1140
T. imbricata, 958
T. rubra, 958
T. sp., 953
Thyonepsolus nutriens, 958, 1227
Thysanoëssa, 811
T. aequalis, 810
T. inermis, 809, 810
T. longipes, 810, 811
T. raschii, 810, 811
T. spinifera, 809-811
Thysanopoda, 810
T. tricuspidata, 810
Tiara pileata, 648
Tigriopus, 763-765, 786, 787, 1199
T. brevicornis, 763, 764, 788, 1140, 1156
T. californicus, 977, 979
T. fulvus, 763, 788, 977-979, 1132, 1152
T. japonicus, 763-765, 786-789, 1020, 1148, 1170, 1210, 1216
Tilapia, 1031, 1032, 1165, 1175, 1200
T. aurea, 1032, 1200
T. nilotica, 1032, 1200, 1210
 Tintinnida (tintinnids), 585, 605, 611, 612, 976, 1157
Tintinnopsis, 611, 612
T. beroidea, 611, 626, 1157
T. lohmani, 605
T. sp., 981, 1157
T. tubulosa, 605, 611, 626
Tintinnus, 978
Tisbe, 765, 766, 786, 787, 1129, 1221
T. clodiensis, 765, 789, 1129, 1179
T. furcata, 765, 769, 789, 980, 1128, 1169, 1171
T. holothuriae (syn.: *T. helgolandica*), 602, 624, 625, 645, 646, 765, 1156, 1167
T. persimilis, 765, 789, 1221
T. pori, 789, 1130
T. reluctans, 765, 789, 1221
T. (=Idyaea) reticulata, 765, 766, 789, 979, 1129, 1132
T. sp., 978, 1221
Tivela mactroides, 654
 toadfish, 1097
Tokophrya infusorium, 615
 tomcod, 1098
 topshell, 1124
Torpedospora sp., 694
Tortanus forcipatus, 785, 1173
Trachurus symmetricus, 1168
T. trachurus, 1089, 1094
 Trachylina, 652
Trapezium japonicum, 927
 Trematoda, 1172
 trepang, 1189
Trichogaster pectoralis, 845
T. trichopterus, 845
Trichomonas foetus, 618
T. gallinae, 618, 619
Tridacna, 935
Triloculina, 596
Tripedalia cystophora, 648, 649, 1224
Tripneustes esculentus, 977
T. gratilla, 954
Triticella koreni, 718

- Tritomania japonica*, 931
Trochodota dunedinensis, 958
Trophodiscus, 1151
Tropholampas loveni, 959
Tropiometra carinata carinata, 948
trout, 808, 821, 835, 875, 969, 978, 1009, 1012,
1017, 1029, 1094, 1095, 1136
trout, brook, 1019, 1022, 1199
trout, brown, 1019
trout, lake, 1154
trout, rainbow, 1013, 1016, 1019, 1028, 1207,
1217, 1221, 1229
trout, sea, 1097
trout, spotted sea, 1124
trout, steelhead, 1196
Truncatus truncatus, 1072
Tryblidiodea, 884
trypanosomatids, 619
trypanosomes, 619
Tubastrea manni, 664
Tubifex, 735, 737, 739, 742, 1169, 1180
T. hattai, 735, 739
T. sp., 654, 671, 816, 873, 980
Tubificidae (tubificids), 726, 739, 1205
Tubularia, 660, 661, 1130, 1144, 1172, 1185,
1190, 1204, 1214, 1216
T. crocea, 652, 660, 661, 665-667
T. larynx, 650
Tubulipora sp., 718
tuna, 978, 979, 1011, 1084, 1098, 1101, 1110,
1167, 1210
tunicates, 742, 934
Turbatrix aceti, 1303
Turbellaria (turbellarians), 583, 668-678, 715,
1126, 1146, 1156, 1171, 1177
Turbo cornutus, 898, 899, 1124
turbot, 1011, 1016, 1017, 1142, 1149
Tursiops, 1162
T. aduncus, 1043
T. gilli, 1040, 1058, 1109
T. sp., 1040
T. truncatus, 1041, 1043, 1047, 1048, 1052-
1054, 1058, 1060, 1062, 1065, 1069, 1075,
1080, 1083, 1086, 1089, 1091-1093, 1109-
1115, 1118, 1121, 1124, 1128, 1147, 1155,
1184, 1203, 1216, 1225
T. truncatus gilli, 1069, 1089
turtles, 798
turtle, grass, 692
tusk shells, 884

Uca pugilator, 880, 1220
Ulothrix, 1006
Ulua, 597, 613, 729, 730, 766, 913
U. lactuca, 613, 726-728, 766, 808, 878, 895,
945, 953

U. pertusa, 925
U. sp., 726, 789, 979
Undaria, 895
U. pinnatifida, 952
U. sp., 896
univalves, 1134
Uronema, 612-614, 1137, 1138
U. marinum, 613-615, 626, 1161, 1180
U. nigricans, 607-610, 626
U. sp., 612, 613, 626, 1160
Urosalpinx, 935
U. cinerea, 931, 1185
Urticina crassicornis, 661

Valkeria wa, 713
Vaucheria, 896
V. sp., 888, 896
Venerupis decussata, 901
V. philippinarum, 824, 827, 853
Venus mercenaria, 1183
Verongia, 629
V. gigantea, 629
Verruca stroemia, 799, 1129
Vibrio, 917, 999
V. sp., 701, 711
Victorella, 1133
viruses, 581
Viscosia carmleyensis, 708
V. macramphida, 704
Volvocales, 593, 594

Wallago attu, 1109
walrus, 1049, 1050, 1072, 1076, 1090, 1093,
1096, 1107, 1119, 1135, 1138, 1139, 1159,
1201, 1203
walrus, Atlantic, 1056, 1186
walrus, Pacific, 1056, 1134, 1135, 1149
whales, 798, 809, 828, 1035, 1038, 1040-1042,
1050, 1052, 1065, 1068, 1069, 1084, 1090,
1097, 1105, 1106, 1110, 1136, 1139, 1150,
1173, 1179, 1181, 1189, 1193, 1194, 1201,
1208, 1211, 1212
whale, Baird's beaked, 1109
whale, blue, 809
whale, bottle-nosed, 1109
whale, Cuvier's beaked, 1109
whale, false killer, 1053, 1110
whale, fin, 1179
whale, grey, 1035
whale, killer, 1046, 1047, 1051-1054, 1058,
1110, 1131, 1136, 1158, 1165, 1166, 1193,
1216
whale, minke, 1035
whale, Pacific pilot, 1110, 1135
whale, pilot (pothead), 1037, 1038, 1049, 1052,
1053, 1058, 1093, 1110, 1135, 1209

- whale, pygmy sperm, 1109
 whale, short-finned pilot, 1040
 whale, sperm, 1059, 1109, 1124, 1154
 whale, white, 1045, 1053, 1058, 1075, 1109, 1129, 1155, 1179
 whitefish, common, 1201
 whiting, 1084, 1086, 1094–1098, 1107, 1110
 worms, 672, 700, 702, 707, 720, 722–726, 728, 729, 732, 733, 735–739, 871, 949, 953, 1169, 1222
 worm, palolo, 723, 724, 1163
 worm, red, 737, 738
 worm, white, 735, 737, 821
- Xanthidae* (xanthids), 1152, 1162
Xiphopeneus kroyeri, 1203
- yeast, 588, 592, 596, 602, 604, 605, 609, 610, 613, 614, 620, 622, 624–626, 679, 682, 683, 686, 689, 703, 704, 710, 711, 746, 761, 763, 787, 788, 820, 828, 833, 853, 896, 913–915, 953, 976, 1006, 1012, 1017, 1088, 1107, 1113, 1153, 1166, 1195, 1210
 yellow-tails, 689, 787, 1019
- Zalerion xylestrix*, 694
Zalophus californianus, 1039, 1055, 1059, 1060, 1072, 1073, 1076, 1077, 1086, 1090, 1096, 1103, 1106, 1108, 1120, 1194, 1198, 1225
Z. californianus wollebaeki, 1056
Zanclaea, 1205
Z. gemmosa, 1205
Z. implexa, 652, 1205
Zanichellia, 597
 zebrafish, 1178
Ziphiidae (ziphiids), 1109, 1147
Ziphius cavirostris, 1109
 zoanthids, 663, 664
Zoanthus, 1202
Z. sandwichensis, 663, 664
Zoarces viviparus, 1089
Zoobotryon pellucidum, 697
Z. verticillatum, 717
 zooxanthellae, 663, 666, 1140, 1145
Zoroaster carinatus, 951
Zostera, 597
Z. marina, 698, 700, 702, 711, 723, 735
Z. sp., 598
Zosteraceae, 766, 789

SUBJECT INDEX

- Aggressiveness, mammals, 1054, 1059
Algal tea, 685
Alloccatalyzers, 616, 623
Allelochemicals, 616
Aluminium application, mammals, 1081, 1082
Amictic females, rotifers, 688
Amino-acid requirements, decapods, 826-830, 832
 fishes, 1013-1015
Amphimixis, 704
Anaesthetic dart guns, 1039
Antagonism, among protozoans, 620
Antibiosis, 620
Antibiotica feeds, 1008
Antibiotics, 587, 588, 591, 595, 599, 611, 615, 633, 686, 774, 777, 916, 917, 997-1004, 1062
Antifertilizin, 941
Antiformin solution, 755
Artificial tube, polychaetes, 720, 721, 728
Artificial upwelling, 582
Asexual reproduction, echinoderms, 956
Assay-organism aspect, of research cultivation, 579
Assay organisms, Annelida, 736, 737
 Branchiopoda, 747
 Bryozoa, 719
 Cirripedia, 807
 Cnidaria, 665, 666
 Copepoda, 786
 Echinodermata, 965, 966
 Malacostraca, 880, 881
 Mollusca, 934
 Nematoda, 707
 Pisces, 1032, 1033
 Porifera, 639
 Protozoa, 620, 621
 Rotifera, 688
 Turbellaria, 678
Auricularia, 939
Autoinhibition, 620
Automatic feeder, 757-759
Axenic cultivation, Protozoa, 613
Axenic cultures, 584
 Nematoda, 702
 Rotifera, 685, 686
Barnum Museum, 1053
Behaviour, importance in cultivation, 580, 581
Bin, bivalve culture, 908
Binders, 833-837
Biochemical interactions, Protozoa, 616-620
Biologische Anstalt Helgoland, 943, 1120
Bipinnaria, 939
Bisexuality, 685
Bottom cultures, bivalves, 928
Body-length requirements, for mammals' capture and transport, 1043
Body temperatures, pinnipeds, 1073, 1074
Brachiolaria, 939
Breakpoint chlorination, 1080
Breeding—*see* Reproduction
Breeding stock, bivalves, 924
Brighton Dolphinarium, 1066, 1068, 1081
Brine shrimp, differences in quality, 759, 760
Brooding, echinoderms, 956-960
Cages, mammals, 1064
Cannibalism, 843, 847, 865, 883
 copepods, 774
Captive, adjustments of mammals, 1050-1062
Capture, mammals, 1036-1043
Carbohydrate requirements, fishes, 1016
Cérophyl, 765
Chastek paralysis, 1086
Chemical pollutants, 1070
Chemostat cultures, rotifers, 684
Chloramines, 1078
Chlorination, mammals, 1077-1081
Chlorine, combined, 1078-1081
 free, 1078-1081
 total, 1078
Chlorine explosion, 1081
Cleaning, brine-shrimp eggs, 755
Climbing abilities, mammals, 1064
Cocoon, 735, 738
Cold storage, mammal food, 1083, 1084
Collectors, bivalve larvae, 917, 918
Competitors, bivalves, 934
Compound larvae, sponges, 633
Conditioners, 616, 617, 623
Condition factor, 987
Conditioned reflex pool, 990
Conditioned reflexes, 991
Conditioning, bivalves, 925
 cirripedes, 802
 gastropods, 897, 898
Container Note 20, mammals, 1049

- Container Note 21, mammals, 1049
 Continuous cultures, brine shrimp, 756, 757
 Conversion efficiency, decapods, 837-840
 Cooperation, among protozoans, 620
 Copper application, mammals, 1081
 Copulation, lobsters, 867-870
 pinnipeds, 1118, 1119
 turbellarians, 674-677
 Counter, for brine-shrimp eggs, 755
 Courtship, mammals, 1121
 Critical period, fishes, 971, 972
 Cryopreservation, 1029, 1030
 Culture enclosure, for brine shrimp, 747, 752
 for fish larvae, 973, 974
 for mammals, 1063-1069
 Culture jar, sponges, 634
 Culture media—*see* Media
 Culture partner, 602, 645, 727
 Culture system, barnacles, 804, 805
 copepods, 767
 lobster juveniles, 865-867
 lobster larvae, 861-865
 natantians, 852
 Culture tube, polychaetes, 720, 721, 728
 Culture-water quality, mammals, 1069-1082
 Cuttings, sponges, 630, 639
 Cystidea, 939
- Daily rations, mammals, 1089-1092
 Day length, effects on fishes, 1021, 1022
 Deficiency symptoms, fishes, 1017, 1018
 Developmental stages, sponges, 636
 Dichloramine, 1078
 Dietary composition, decapods, 823-832
 fishes, 1008-1020
 Dietary salt, 1071
 Dietary salt supplementation, fishes, 1082
 mammals, 1076, 1077
 Dietary sodium, 1017
 Diets—*see also* Food and Nutrition
 bivalves, 914, 915
 decapods, 815-823, 833-837, 884
 see also Nutritional requirements,
 Decapoda
 fish larvae, 979, 980
 fishes, 1005-1020
 iodine, 1082
 iron, 1082
 salt, 1082
 general characteristics of, 583
 micro-encapsulated, 583
 rotifers, 682-689
 Digestion, echinoderms, 945, 946
 Dipleurula, 939
 Directional colony growth, bryozoans, 714,
 715
- Disinfection, mammals, 1077
 Dissociated cells, sponges, 631
 Dissolved organic matter, 946
 Doliolaria, 939
 Dolphin shows, 1059, 1060
 Dominance, fish schools, 990
 Doubling times, amoeba, 594
 Drinking, mammals, 1076
 Dry feeds, fishes, 1005
 Duisburg Dolphinarium, 1065, 1068
- Ectohormones, 616
 Egg production, copepods, 780, 783
 Egg-shell contamination, brine shrimp, 755
 Eggs of brine shrimp, cleaning, 755, 756
 differences in quality, 759
 dissolved-gases effects, 745
 light effects, 745, 746
 light trigger, 745
 salinity effects, 745
 separation of egg shell and nauplii, 748-751
 sterilization, 755, 756
 temperature effects, 745
 Egg storage, echinoderms, 939
 Embayment culture, prawns, 855
 Encapsulated diets, 583, 1199
 Energetic efficiencies, decapods, 839
 Energy budget, decapods, 839
 Enrichment, amoeba cultures, 592
 ciliates, 612
 Erdschreiber—*see also* Media and Soil extract,
 597
 Erysipelas, 1062
 Essentials of culture techniques, Annelida,
 739-742
 Brachyura, 873, 874, 883, 884
 Branchiopoda, 761
 Bryozoa, 719, 720
 Cirripedia, 799, 800, 807
 Cnidaria, 641, 642, 648, 652, 661, 666-668
 Copepoda, 787-798
 Echinodermata, 966, 967
 Euphausiacea, 809-812
 Gastropoda, 887, 889
 Malacostraca, 881-884
 Mammalia, 1121-1123
 Mollusca, 934-936
 Nematoda, 708, 709
 Pisces, 1033-1035
 Porifera, 640, 641
 Protozoa, 621-627
 Rotifera, 689-691
 Turbellaria, 678
 Experimentation, mammals, 1060
 Explants, sponges, 630
 Exploited populations, copepods, 765

- Fasting, pinnipeds, 1102
 Fattening, prawns, 855
 Feeding habits, echinoderms, 947-954, 967
 mammals, 1102
 Feeding schedule, 1018, 1020
 mammals, 1092
 Feeds—*see also* Nutrition
 dry, 1005
 pelleted, 833-837, 1006-1008
 semi-moist, 1005
 wet, 1005
 Fertilization, bivalves, 903, 904
 echinoderms, 938-941
 fishes, 968, 969
 gastropods, 885, 886
 Fertilizin, 940, 941
 Filter nets, 740
 Filtration rate, copepods, 780, 784
 rotifers, 682, 683
 Fish-worm production, 738, 739
 Floating pens, mammals, 1040
 Flocculation, 1072
 Food—*see* Nutrition
 Food organisms, algae, 570, 593-607, 611-
 613, 615, 622-626, 629, 631, 634, 673,
 679-683, 685-688, 695, 696, 700, 703,
 710-713, 716-719, 722-735, 739, 746,
 747, 760, 763, 764, 766-781, 783-785,
 788, 797, 799-801, 803, 806, 807, 809-
 811, 815, 817-821, 824, 826, 838, 853,
 856, 857, 875, 884, 887-889, 892-897,
 908-916, 922-924, 936, 942, 943, 947,
 953, 954, 975-980, 983-986, 1006, 1007
 Annelida, 737-739
 Bacteria, 592, 595, 603, 606, 612, 613, 615,
 624-626, 628, 629, 695, 696, 698, 700-
 702, 704, 710-712, 897, 945
 Branchiopoda, 747-761
 Bryozoa, 719
 Cirripedia, 807
 Copepoda, 786, 787
 Cnidaria, 666, 722, 723, 727
 Echinodermata, 966
 Fungi, 614, 692-695, 697, 710, 711
 Malacostraca, 880, 881
 Mollusca, 934
 Nematoda, 707, 708
 Pisces, 1033
 Porifera, 640
 Protozoa, 621
 Rotifera, 688, 689
 Turbellaria, 678
 Food-organism aspect, of research cultiva-
 tion, 579
 Food-particle size, decapods, 817, 818
 Food pellets, 833-837
 fishes, 1006-1008
 Food preference, fish larvae, 986, 987
 Food ration, decapods, 837-840
 fishes, 1018, 1019
 Food selectivity, fish larvae, 986, 987
 Food storage, mammals, 1083-1085
 Force feeding, mammals, 1087-1090
 Freezing, mammal food, 1083, 1084
 Functional response, 985
 Fundamental aspect, 579
 of research cultivation, 579
 Fungus infection, decapods, 845
 Fusion, sponges, 631

 Gamete maturation, bivalves, 924, 925
 echinoderms, 954-960
 fishes, 1020-1023
 gastropods, 892-898
 Gamete release, bivalves, 925-928
 echinoderms, 960-965
 fishes, 1020, 1023-1029
 gastropods, 898-900
 Gause-Lotka-Volterra model, 1358
 Gemmulae, 627, 629
 Generation time, 603, 604, 767, 782, 784, 788-
 794
 annelids, 734
 copepods, 776, 777
 nematodes, 696, 698-701, 704, 705, 709
 protozoans, 600, 604, 606
 Genetic recombination, fishes, 1029, 1031,
 1032
 Giant formation, suctorians, 615
 Gill net, 1039-1041
 Gonadotropin, 1023, 1024
 Growth inhibitors, 989
 Growth-promoters, 616-619, 623
 Growth rates, bivalves, 914-916, 923
 brine shrimp, 746
 bryozoans, 717
 cnidarians, 643, 655-657
 copepods, 772, 773, 778, 779, 782, 784
 decapods, 823, 880
 fishes, 1013, 1014
 gastropods, 888, 889, 892, 893
 lobsters, 862, 865, 868
 nematodes, 694, 696-698, 700, 703
 pinnipeds, 1120, 1121
 Gynogenesis, fishes, 1031

 Harderwijk Dolfinarium, 1107, 1113
 Harvester, brine shrimp, 748-752
 Hatcher, brine shrimp, 748-754
 Hatching, bivalves, 903, 904
 echinoderms, 940, 941
 fishes, 970, 971

- Hatching—*continued*
 gastropods, 885, 886
 Hatching enzyme, echinoderms, 941
 Hatching of brine shrimp, dissolved-gases
 effect, 745, 746
 light effects, 745, 746
 salinity effects, 745
 temperature effects, 745
 Hibernacula, 713
 Hoop net, 1039, 1040
 Hormone-induced breeding, fishes, 1023–1029
 Hybridization, fishes, 1031
 Hyperchlorination, 1080
see also Chlorination
 Implantation, 1119
 delay, 1119
 Incubation, 844
 bivalves, 903, 904
 copepods, 765
 echinoderms, 940
 fishes, 969–971
 gastropods, 885, 886
 Incubators, brine shrimp, 748–754
 fishes, 969, 970
 lobsters, 860
 Induction of gamete release, echinoderms,
 960–965
 Induction of metamorphosis, hydrozoans, 659
 Ingestion rate, copepods, 781
In situ cultures, Bivalvia, 928–933
 Porifera, 638, 639
 International Air Transport Association, 1040
 Kamogawa Sea World, 1067, 1069
 Lactation, odontocetes, 1111
 pinnipeds, 1119
 Lettuce tea, 685
 Light, as trigger of development, 745, 746
 Light effects, bivalve larvae, 904
 Life cycle, Brachyura, 876
 Cirripedia, 803
 Copepoda, 762
 Cubozoa, 649
 Decapoda, 813, 850, 852, 853, 860, 861,
 871, 872
 Echinodermata, 939
 Nematoda, 699, 703, 705, 706
 Porifera, 636
 Scyphozoa, 645–647
 Limnic forms, rotifers, 684–688
 Lipid requirements, fishes, 1016
 Longevity, mammals, 1054–1058
 Long-line method, bivalves, 930, 931
 LOOSANOFF-DAVIS method, bivalve culture,
 911
 Magnesium deficiency, fishes, 1016
 Marine Bioscience Facility, 1067, 1069
 Marineland Enoshima, 1067, 1069
 Marineland of Florida, 1053
 Marineland of the Pacific, 1068, 1069
 Marine Mammal Protection Act, 1043
 Mass cultures, brine shrimp, 753–755
 cirripedes, 803
 copepods, 766
 lobsters, 861–870
 prawns, 851
 rotifers, 682
 Mating—*see* Copulation
 Media, Protozoa, 586–620
 Walne, 602, 604
 Metamorphosis, bivalves, 917–921
 gastropods, 895
 hydrozoans, 659
 Miami Seaquarium, 1069
 Micro-capsules, bivalves, 915
 Microencapsulation, 583
 Mictic females, rotifers, 688
 Migration, lugworms, 722
 Milk composition, odontocetes, 1111–1114
 pinnipeds, 1103, 1104
 Milk formula, pinnipeds, 1105, 1106
 Mineral requirements, fishes, 1016, 1017
 Minerals, decapods, 828, 831, 832
 Miquel sea water, 682
 Miquel's solution, 770
 Mito-Aquarium, 1053
 Moby Doll, 1053
 Monochloramine, 1078
 Mono-sex cultures, fishes, 1031, 1032
 Mucus bag, 740, 742
 Mucus filter, 741, 742
 Mucus net, 741
 Namu, 1053
 Natural food, decapods, 814, 815
 Netting, mammals, 1039–1042
 Non-digestible items swallowed, mammals,
 1092, 1093
 Nutrition—*see also* Food organisms and
 Feeds
 Amphipoda, 808
 Annelida, 722–763
 Bivalvia, 906–916
 Bryozoa, 710–714, 716–718
 Cnidaria, 641–644, 646–648, 650, 652–665
 Crustacea, Branchiopoda, 746, 752–754
 Cirripedia, 799–801, 803–807

Nutrition—*continued*

- Copepoda, 760–786, 788–798
 Decapoda, 814–840, 842–849, 851, 853,
 854, 856–859, 864, 871, 873–884
 Euphausiacea, 808–812, 814
 Isopoda, 808
 Mysidacea, 808
 Echinodermata, 942–954
 Gastropoda, 886–894
 Mammalia, 1082–1115
 Nematoda, 692–698, 700–704, 706, 709
 Pisces, 974–988, 1005–1020
 Porifera, 628–630
 Protozoa, 584–627
 Rotifera, 679–689, 691
 Turbellaria, 668–673, 678
- Oestrus, 1119, 1121
 Off-bottom cultures, bivalves, 929–931
 Operant conditioning, 1059
 Oregon starter mash, 1011
 Oregon vitamin premix, 1011
 Overfeeding, pinniped pups, 1106
 Oviparity, 743, 744
 Ovoviviparity, 743, 744
- Parthenogenesis, 685, 704
 Parturition, 1119
 Pelleted dry foods, decapods, 833–837
 fishes, 1006–1008
 Penis reduction, barnacles, 804
 Penis regeneration, barnacles, 804
 Pentacrinula, 939
 Pentactula, 939
 Petri dish, 581
 Pheromones, 580, 616, 919, 1125
 Photoperiod—*see* Day length
 Phytotelmata, 1339
 Piscidine, 713, 719, 723, 739, 740
 Pituitary gland, fishes, 1023, 1027, 1028
 Pluteus, 939
 Point of no return, 987
 Poison producers, bivalve cultures, 934
 Polyspermy, 733
 Polystream, 919, 933
 Predators, bivalves, 931–934
 Pre-enrichment, amoeba cultures, 592
 Prey catching, fish larvae, 991–998
 mammals, 1102
 Probiotics, 616, 617, 623
 Protein requirements, decapods, 823–825
 fishes, 1013–1015
 Pseudo-copulation, echinoderms, 956
 Pursé seine, 1039–1042
- Quicklime, 932
 Rabbit units, 1027
 Rack method, bivalves, 929, 930
 Raft method, bivalves, 930
 Reactive perceptive field, 995–997
 Recycling, 582
 Red tide—*see* Poison producers
 Reduction bodies, sponges, 631
 Reflex pool, 991
 Regeneration, annelids, 724
 Reproduction, Annelida, 724, 727, 729–731,
 733–735, 737, 738
 Bivalvia, 924–928
 Branchiopoda, 744–747
 Bryozoa, 710–713, 716
 Cirripedia, 802, 803, 805
 Cnidaria, 642–649, 654, 656, 658, 663
 Copepoda, 763–765, 768–786
 Decapoda, 842, 844, 848, 852–856, 867–870
 Echinodermata, 938, 954–965
 Gastropoda, 885, 886, 897–900
 Mammalia, 1115–1121
 Nematoda, 698–702
 Pisces, 968–971, 1020–1029
 Protozoa, 588–591, 597, 599–601, 603, 605,
 606, 608–611, 613–615
 Rotifera, 679–683, 685, 689–691
 Turbellaria, 674–677
- Resting buds, 713
 Resting eggs, brine shrimp, 744
 copepods, 769
 Restraining cage, mammals, 1044, 1045
 Rubbers, source of contamination, 1402–1407
 Rules, capture of mammals, 1042, 1043
 mammal feeding, 1114, 1115
 transport of mammals, 1049, 1050
- Salinity effects, bivalve larvae, 905, 906
 Salinity requirements, mammals, 1075–1077
 Salt deficiency, mammals, 1077
 Salt load, fish foods, 1016, 1071
 Salt tolerance, mammals, 1076, 1077
 Santini box, 1046
 Schooling, fishes, 989–991
 Scyphistoma, 642
 Sea-star mop, 932
 Sea-thermal power plant, 582
 Sea water, collection of, 583
 Sea World, 1054
 Seedling production, prawns, 854
 Seedling transportation, prawns, 854, 855
 Seine, 1039–1042
 Semi-moist feeds, fishes, 1005

- Sensory input, fish larvae, 989
 Sensory stimulation, fish larvae, 988, 989
 Separator, brine shrimp, 748-751
 Setting, bivalves, 917-921
 gastropods, 895
 Sex determination, copepods, 765
 Sex ratio, pinnipeds, 1120
 Shamu, 1054
 Shedding substance, echinoderms, 961, 962
 Shedhibin, 962
 Size-hierarchy effect, 989
 Skin digestion, echinoderms, 946
 Skin harpoons, 1039
 Skin shedding, mammals, 1060, 1061
 Slime ball, 742
 Slime net, 742
 Sling, canvas, 1047
 hammock-like, 1046
 padded, 1047
 pole, 1046, 1047
 Snares, 1038
 head, 1038
 tail, 1038
 Soil extract, 686—*see also* Erdschreiber
 Solcosplen, 1027
 Spat, bivalves, 921-923
 cultchless, 921, 922
 free, 921, 922
 Spat collection, 921
 Spat collectors, 917, 918, 921
 Spatfall, bivalves, 917, 918
 Spawning—*see also* Gamete release and
 Reproduction
 echinoderms, 955, 956
 gastropods, 899
 Spermatophores, 649
 Spermatozeugmata, 649
 Spermatozoa
 of echinoderms, storage, 938, 939
 of fishes, storage, 1029, 1030
 Starvation, fishes, 987
 Starvation potential, 987, 988
 Stechkasten, 722
 Stick method, bivalves, 930
 Stimulation, among protozoans, 620
 of bivalve gamete release, 925-928
 of gastropod gamete release, 898, 899
 Stock improvement, fishes, 1029-1032
 Stocking, prawns, 846, 856
 Stomach tube, 1087, 1090, 1107
 Storage, eggs, 939
 mammal food, 1083-1085
 spermatozoa, 938, 939
 Striking posture, fish larvae, 991, 992
 Stripping, bivalves, 928
 fishes, 969
 dry method, 969
 semi-dry method, 969
 wet method, 969
 Strobilation, 642-645, 647
 Substratum, annelids, 734, 735
 attraction of bivalve larvae, 919, 920, 935
 bivalve setting, 917, 918, 935
 Sunburn, mammals, 1061, 1062
 Swimming, fish larvae, 973
 drift-bursts, 973
 perpetual swimming, 973
 swim-gliding, 973
 Switching, 985, 995
 bryozoans, 719
 Symbiosis, 620
 Symbiotic algae, 669-671
 Synahorin, 1027, 1028
 Syntrophy, 620

 Telemediateurs, 616, 623
 Temperature, effects on bivalve larvae, 904-906
 Temperature requirements, mammals, 1072-1075
 Tetramin, 765, 808
 Thermoregulation, mammals, 1073-1075
 Thiamine deficiency, 1085, 1086
 Thinning, bivalves, 929
 Throw-net, 1039
 Training, mammals, 1059, 1060
 Transport, mammals, 1043-1051
 Trap net, 1039, 1042
 Tray method, bivalves, 931
 Trepan, 937
 Trichloramine, 1078
 Trochophore, 720, 724, 727
 Twins, pinnipeds, 1120

 Underwater farms, lobsters, 870
 Upwelling, artificial, 582

 Vancouver Aquarium, 1053
 Versenate, 657, 744
 Visual field, fish larvae, 982
 Vitamins, 589, 595, 602, 608, 609, 670, 686, 687, 823, 828-832, 1010-1012, 1016-1019, 1082, 1084-1088
 Vitawil, 731, 739
 Volume of water searched, fish larvae, 997, 998

- WAKAMOTO, 764
Walne medium, 602, 604
Water balance, mammals, 1076, 1077
Water depth, effects on bivalve larvae, 906,
907
Water requirements, pinnipeds, 1107
Water treatment, mammals, 1071, 1072
Wave length, effect on fishes, 1022
WELLS-GLANCY method, bivalve culture, 911
Wet feeds, fishes, 1005
White spot disease, decapods, 847
Yokohama Aquarium, 1053